

WAC LIGHTING

Responsible Lighting®

2014 New Product



Functional



Quick Connect™



Decorative

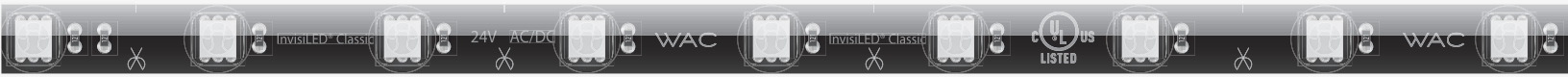

Power: 2W / ft
Lumens: Up to 115 lm / ft
CRI: 85
Rated Life: 50,000 hours

- 5 colors: White, Amber, Blue, Green, Red
- Designed for accent lighting
- UL listed for damp location
- 5 year warranty

- Maximum run length 40 feet
- May be field cut every 2 inches at the end of a run
- Dimmable with an Electronic Low Voltage (ELV) dimmer

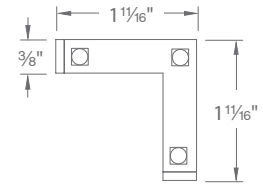
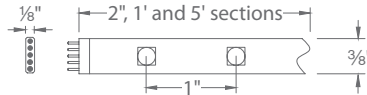

Tape Selections

System	Length	Qty	Color
LED-T24	2IN 2 inches	1	AM Amber 590-595nm
	1 1 foot	1	BL Blue 465-470nm
	5 5 feet	1	GR Green 515-520nm RD Red 625-630nm
LED-T2430	2IN 2 inches	1	WT White 3000K
	2IN-10 2 inches	10	
	1 1 foot	1	
	1-40 1 foot	40	
	5 5 feet	5	

3 LED "L" Connector

LED-T2430-3L-WT	White	3000K
------------------------	-------	-------

Example: **LED-T2430-1-40-WT**

Class 2 Power Supply for Classic 24V (Required)

Type	Model	Power	Dim	Input	Output	
Remote	EN-2460-RB2-T	60W	Yes	120V AC	24V AC	Includes a 6 foot lead wire
	EN-24100-RB2-T	96W			24V AC	
Plug-in	EN-2460-P-AR-T	60W	Yes	120V AC	24V AC	Includes a 6 foot lead wire
	EN-24100-P-AR-T	96W			24V AC	
Remote 277V	EN-24100-277-R	96W	No	277V AC	24V DC	Order with LED-TC-B-2 or LED-T-EXT-144

Accessories

Rigid Aluminum Channel	LED-T-CH	5 ft	Includes mounting hardware and diffuser lens
Lead Wire	LED-TC-P-2 LED-TC-P-12	2 ft 12 ft	Alternative lengths for power supplies
Extension Cable	LED-TC-EXT-144	12 ft	Extends distance between a hard wired power supply or wiring box to a tape section
Wiring Box With Switch	TB-S	L: 6 1/4 in W: 1 5/8 in H: 1 1/4 in	Use when spanning a large gap in a system layout without leaving exposed wiring
Low Voltage Wiring Box	LED-T-B	L: 1 1/2 in W: 3/4 in H: 7/8 in	Neatly house up to two wires
Low Voltage Wiring Box With Feed	LED-TC-B-2	L: 1 1/2 in W: 3/4 in H: 7/8 in	Neatly house up to two wires With 2" female feed

Joiner Cable	LED-TC-IC2 2 in LED-TC-IC6 6 in LED-TC-IC12 12 in LED-TC-IC36 36 in LED-TC-IC72 72 in	Use between tape sections
4-Way "X" Connector	LED-TC-X	
3-Way "Y" Connector	LED-TC-Y	
"L" Connector	LED-TC-L	
End cap	LED-TC-EC	1 cut end cap 1 male end cap
Mounting Clips	LED-T-CL	10 Qty
Retrofit Channel	LED-T-RC	36 in

TASK | FUNCTIONAL

InvisiLED® Pro Outdoor NEW

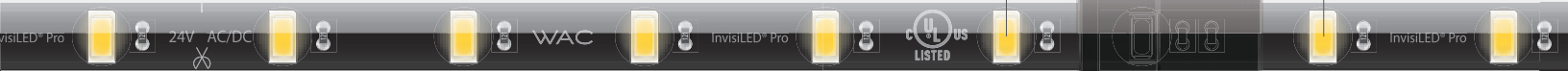

- Power:** 3.5W / ft
- Lumens:** Up to 220 lm / ft
- CRI:** 85
- Rated Life:** 50,000 hours
- IP-68 Rated, UL listed for wet location
- Maximum run length of 28 ft
- May be field cut at the end of a run
- 5 year warranty

Featured Product: **LED-T2435-5-WT**

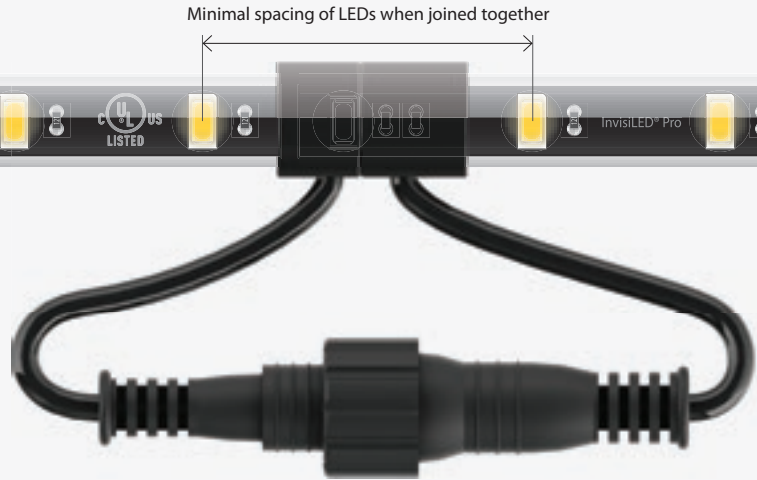

Double insulated silicon encasement and distinct electrical and mechanical junctions make for a superior watertight custom system

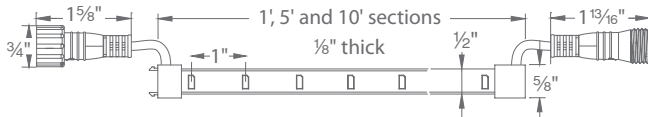

Tape Selections



System	Length	Color	Power consumption
LED-TO2435	1 1 foot	WT White 3500K	3.5W / ft
	5 5 feet		
	10 10 feet		



Example: **LED-TO2435-10-WT**

Class 2 Power Supply for Pro Outdoor (Required)

Type	Model	Power	Input	Output
Remote 	EN-O24100-RB2-T	96W	120V - 277V AC	24V DC <i>Includes a 6 foot lead wire</i>

Accessories

Clear Channel 	LED-TO24-CH1 1 foot LED-TO24-CH5 5 feet
End cap 	LED-TO24-EC
Mounting Clip 1 	LED-TO24-C1 <i>Secures on both edges (10 Qty)</i>
Mounting Clip 2 	LED-TO24-C2 <i>Secures on one edge (10 Qty)</i>
Mounting Clip 3 	LED-TO24-C3 <i>Spring clip secures beneath tape (10 Qty)</i>

Joiner Cable 	LED-TO24-IC6 6 in LED-TO24-IC12 12 in LED-TO24-IC72 72 in LED-TO24-IC120 120 in <i>Use between tape sections</i>
4 Way "X" Connector 	LED-TO24-X
3-Way "Y" Connector 	LED-TO24-Y

TASK | FUNCTIONAL

InvisiLED® Pro2



Power: 4W / ft
Lumens: Up to 330 lm / ft
CRI: 85
Rated Life: 50,000 hours

- Brightest InvisiLED® system available
- Designed for super bright cove or task lighting
- UL listed for damp location
- 5 year warranty

- Maximum run length of 25 feet
- May be field cut every 6 inches at the end of a run
- Dim with an Electronic Low Voltage (ELV) dimmer

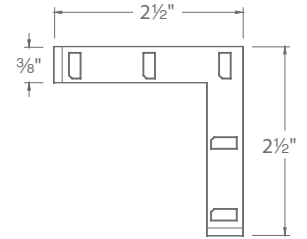
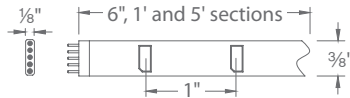

Tape Selections

System	Color Temp	Length	Qty	Finish
LED-TX24	27 2700K	6IN 6 inches	1	WT White
	30 3000K	1 1 foot	1	
	35 3500K	5 5 feet	1	
	45 4500K	1-40 1 foot	40	

Example: **LED-TX2435-6IN-WT**

5 LED "L" Connector

System	Color Temp	Finish
LED-TX24	27 2700K	5L-WT White
	30 3000K	
	35 3500K	
	45 4500K	

Example: **LED-TX2435-5L-WT**

Class 2 Power Supply for Pro 2 (Required)

Type	Model	Power	Dim	Input	Output
Remote	EN-2460-RB2-T	60W	Yes	120V AC	24V AC
	EN-24100-RB2-T	96W			24V AC
Plug-in	EN-2460-P-AR-T	60W	Yes	120V AC	24V AC
	EN-24100-P-AR-T	96W			24V AC
Remote 277V	EN-24100-277-R	96W	No	277V AC	24V DC

Accessories

Rigid Aluminum Channel	LED-T-CH	5 ft	Includes mounting hardware and diffuser lens
Lead Wire	LED-TC-P-2 LED-TC-P-12	2 ft	Alternative lengths for power supplies
		12 ft	
Extension Cable	LED-TC-EXT-144	12 ft	Extends distance between a hard wired power supply or wiring box to a tape section
Wiring Box With Switch	TB-S	L: 6 1/4 in W: 1 5/8 in H: 1 1/4 in	Use when spanning a large gap in a system layout without leaving exposed wiring
Low Voltage Wiring Box	LED-T-B	L: 1 1/2 in W: 3/4 in H: 7/8 in	Neatly house up to two wires
Low Voltage Wiring Box With Feed	LED-TC-B-2	L: 1 1/2 in W: 3/4 in H: 7/8 in	Neatly house up to two wires With 2" female feed

Joiner Cable	LED-TC-IC2 LED-TC-IC6 LED-TC-IC12 LED-TC-IC36 LED-TC-IC72	2 in	Use between tape sections
		6 in	
		12 in	
		36 in	
		72 in	
4-Way "X" Connector	LED-TC-X		
3-Way "Y" Connector	LED-TC-Y		
"L" Connector	LED-TC-L		
End cap	LED-TC-EC	1 cut end cap 1 male end cap	
Mounting Clips	LED-T-CL	10 Qty	
Retrofit Channel	LED-T-RC	36 in	

TASK | FUNCTIONAL

InvisiLED® Pro



Power: 3W / ft
Lumens: Up to 215 lm / ft
CRI: 85
Rated Life: 50,000 hours

- Designed for bright cove or task lighting
- 5 year warranty
- UL listed for damp location

- Maximum run length of 33 feet
- May be field cut every 2 inches at the end of a run
- Dim with an Electronic Low Voltage (ELV) dimmer

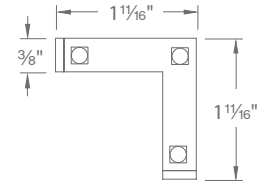
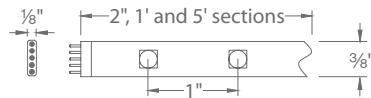

Tape Selections

System	Color Temp	Length	Qty	Finish
LED-T24	W 2700K	2IN 2 inches	1	WT White
	P 3000K	2IN-10 2 inches	10	
	35 3500K	1 1 foot	1	
	C 4500K	5 5 feet	1	
		1-40 1 foot	40	

Example: **LED-T24W-1-40-WT**

3 LED "L" Connector

System	Color Temp	Finish
LED-T24	W 2700K	3L-WT White
	P 3000K	
	35 3500K	
	C 4500K	

Example: **LED-T24W-3L-WT**

Class 2 Power Supply for Pro (Required)

Type	Model	Power	Dim	Input	Output
Remote	EN-2460-RB2-T	60W	Yes	120V AC	24V AC
	EN-24100-RB2-T	96W			24V AC
Plug-in	EN-2460-P-AR-T	60W	Yes	120V AC	24V AC
	EN-24100-P-AR-T	96W			24V AC
Remote 277V	EN-24100-277-R	96W	No	277V AC	24V DC

Accessories

Rigid Aluminum Channel	LED-T-CH	5 ft	Includes mounting hardware and diffuser lens
Lead Wire	LED-TC-P-2 LED-TC-P-12	2 ft 12 ft	Alternative lengths for power supplies
Extension Cable	LED-TC-EXT-144	12 ft	Extends distance between a hard wired power supply or wiring box to a tape section
Wiring Box With Switch	TB-S	L: 6 1/4 in W: 1 5/8 in H: 1 1/4 in	Use when spanning a large gap in a system layout without leaving exposed wiring
Low Voltage Wiring Box	LED-T-B	L: 1 1/2 in W: 3/4 in H: 7/8 in	Neatly house up to two wires
Low Voltage Wiring Box With Feed	LED-TC-B-2	L: 1 1/2 in W: 3/4 in H: 7/8 in	Neatly house up to two wires With 2" female feed

Joiner Cable	LED-TC-IC2 2 in LED-TC-IC6 6 in LED-TC-IC12 12 in LED-TC-IC36 36 in LED-TC-IC72 72 in	Use between tape sections
4-Way "X" Connector	LED-TC-X	
3-Way "Y" Connector	LED-TC-Y	
"L" Connector	LED-TC-L	
End cap	LED-TC-EC	1 cut end cap 1 male end cap
Mounting Clips	LED-T-CL	10 Qty
Retrofit Channel	LED-T-RC	36 in

LINE™

LED Edge Lit Task Luminaires

- Rated Life:** 80,000 hours
- Color Temp:** 3000K
- CRI:** 85
- Dimming:** 100% – 10%

- Seamless connections for the perfect glare-free solution for reflective task surfaces
- Luxurious color rendering for full color spectrum illumination
- High/Low switch for optimal lighting control
- Detachable design for ease of installation and maintenance

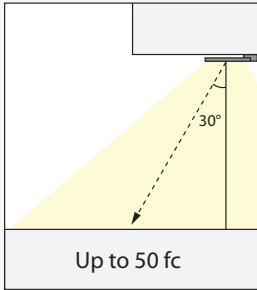

Professional, asymmetrical forward throw illumination for full coverage of the task plane

Max Fixture Run

Model	Length	Power	Lumens	Finish	60 W Trans	96 W Trans
LN-LED06-30-AL	6"	7 W	280	Brushed Aluminum	8	13
LN-LED12-30-AL	12"	12.5 W	600		4	7
LN-LED18-30-AL	18"	19 W	955		3	5
LN-LED24-30-AL	24"	23 W	1245		2	4
LN-LED30-30-AL	30"	26 W	1345		2	3

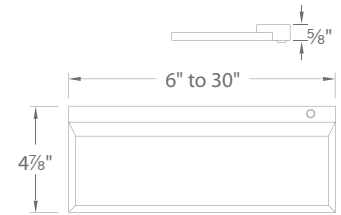

TASK | FUNCTIONAL

120V Class 2 Electronic Transformers

Type	Model	Dim	Input	Output
Remote	EN-2460-RB2-S	Yes	120V	24V AC/60W
	EN-24100-RB2-S			24V AC/96W
Plug-In	EN-2460-P-AR-S	Yes	120V	24V AC/60W
	EN-24100-P-AR-S			24V AC/96W

Includes 6' cord and 5 SL-WC-1 clips.

277V Class 2 Electronic Transformer

Remote	EN-24100-277-R	No	277V	24V DC/100W
--------	-----------------------	----	------	-------------

Includes 1' input and output wires.

Connection Accessories

SL-I	"I" Connector	SL-IC-06	6" Joiner Cable
SL-IF	Joiner Cable Extender	SL-IC-12	12" Joiner Cable
SL-X	X Connector	SL-IC-24	24" Joiner Cable
SL-Y	Y Connector	SL-IC-36	36" Joiner Cable

Power Supply Accessories

TB-S	Wiring box	Use when spanning a large gap in a system layout without exposed wiring.
MTB-06	6 output terminal block	Neatly wire multiple output connections.
MTB-08	8 output terminal block	
SL-EXT-144	12' extension cable	Extends distance between a power supply or wiring box to a LINE section.
SL-WC-1	Wire Clip	Use to neatly tack down cords and cables.



Straight Edge™

Dimming: 100% – 1%
Rated Life: 50,000 hours

- Each section includes two flat mounting clips, two 45° angle mounting clips and one "I" connector
- Extruded aluminum with spread diffuser lens
- Adjustable angle mounting clips allow fixture to be easily aimed while securely mounted for optimal task lighting performance and flexibility



Adjustable angle mounting clip **SL-C3-WT**
 (order separately)

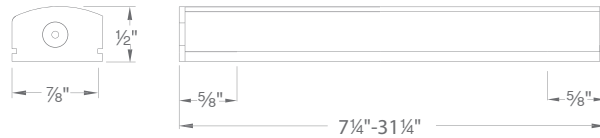

Model	Length	Color Temp	Finish	Power	Max Lumens	CRI
LS-LED	08 7 1/4"	W C 2700K 4500K	WT White	2.6 W	130	85
	14 13 1/4"			4.8 W	245	
	20 19 1/4"			7.2 W	352	
	26 25 1/4"			9.6 W	484	
	32 31 1/4"			11.9 W	617	

Example: **LS-LED08-C-WT**

120V Class 2 Electronic Transformers

Type	Model	Dim	Input	Output
Remote	EN-2460-RB2-S	Yes	120V	24V AC/60W
	EN-24100-RB2-S			24V AC/96W
Plug-In	EN-2460-P-AR-S	Yes	120V	24V AC/60W
	EN-24100-P-AR-S			24V AC/96W

Includes 6' cord and 5 SL-WC-1 clips.

277V Class 2 Electronic Transformer

Remote	EN-24100-277-R	No	277V	24V DC/100W
--------	-----------------------	----	------	-------------

Includes 1' input and output wires.

Mounting Accessories

SL-C1-WT	Flat Mounting Clip
SL-C2-WT	45° Mounting Clip
SL-C3-WT	Adjustable Angle Mounting Clip
MAG-TAPE-36	Magnetic Tape

Power Supply Accessories

TB-S	Wiring box	Use when spanning a large gap in a system layout without exposed wiring.
MTB-06 MTB-08	6 output terminal block 8 output terminal block	Neatly wire multiple output connections.
SL-EXT-144	12' extension cable	Extends distance between a power supply or wiring box to a Straight Edge section.
SL-WC-1	Wire Clip	Use to neatly tack down cords and cables.

Connection Accessories

SL-I	"I" Connector	SL-IC-06	6" Joiner Cable
SL-IF	Joiner Cable Extender	SL-IC-12	12" Joiner Cable
SL-X	X Connector	SL-IC-24	24" Joiner Cable
SL-Y	Y Connector	SL-IC-36	36" Joiner Cable

LEDme[®] Light Bars **NEW**

Color Temp: 3000K
 CRI: 85
 Dimming: 100% – 10%
 Rated Life: 50,000 hours

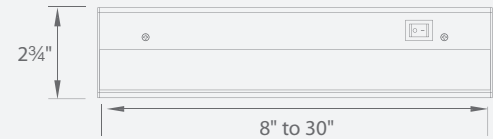

TASK | FUNCTIONAL

Color Temp	Model	Length	Finish	Power	Lumens
3000K	BA-LED	2 8"	BB Bronze SN Satin Nickel WT White	3.6 W	130
		4 12"		6.2 W	255
		6 18"		9.7 W	400
		8 24"		12.7 W	505
		10 30"		15.5 W	655
2700K	BA-LED	2-27 8"	BB Bronze SN Satin Nickel WT White	3.6 W	150
		4-27 12"		6.2 W	285
		6-27 18"		9.7 W	465
		8-27 24"		12.7 W	584
		10-27 30"		15.5 W	694

Example: **BA-LED4-27-WT**

- May be hard-wired with 120 volt power or used with a plug-in power cord
- Subsequent fixtures may be powered with "I" Connector or Interconnect Cable carrying 120 volts
- May be individually switched and/or wired to a wall box

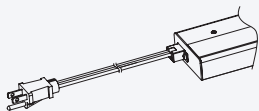

Power Cord

Model	WT	Length
BA-PC6	WT	White 6'
	BK	Black

Supplies power in any application.

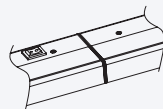

"I" Connector

Model
BA-I-WT

Interconnection for seamless end to end transitions. Included with each light bar.

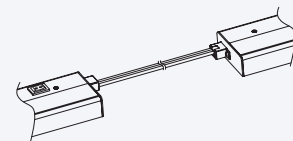

Interconnect Cable

Model	WT	Length
BA-IC12 BA-IC24 BA-IC36	WT	White 12"
	BK	Black 24"
		Black 36"

Links two light bars using a single power connection.

LEDme® Button Light NEW

Recessed or Surface Mount



- Power:** 4.8 W
- Lumens:** Up to 180 (round), Up to 156 (square)
- Compares To:** 15 W Xenon Bi-pin
- CRI:** 85
- Dimming:** 100% – 10%
- Rated Life:** 50,000 hours
- Cutout:** 2 1/8"

Same cutout for recessed applications

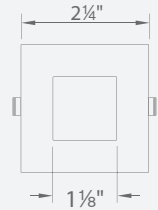
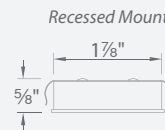
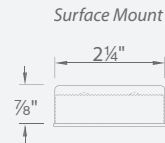
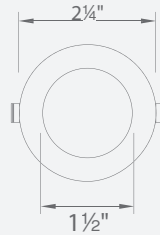

Model	Color temperature	Finish
HR-LED87 HR-LED87S	Round Square 3000K	BK Black BN Brushed Nickel CB Copper Bronze CH Chrome DB Dark Bronze WT White Includes 6 foot lead wire
HR-LED87-27 HR-LED87S-27	Round Square 2700K	

Example: **HR-LED87S-WT**

TASK | FUNCTIONAL

Class 2 Electronic Transformers (Required)

- Minimizes wiring back to transformer



Type	Model	Dim	Input	Output	Power Up To
Remote	EN-2460-RB2			24V AC/60W	12 x LED87
	EN-24100-RB2	Yes	120V	24V AC/96W	20 x LED87
Plug-In	EN-2460-P-AR	Yes	120V	24V AC/60W	12 x LED87

Includes 6' cord and 5 SL-WC-1 clips.

Single transformer may power up to 20 button lights

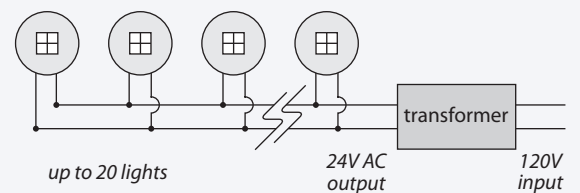

LEDme® Steplight - Rectangle NEW



LED100
Stainless Steel Finish

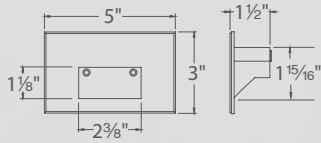

LED200
Black Finish

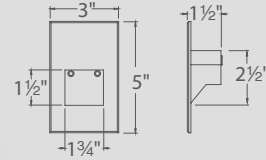

- | | | |
|---------------------------------|---|---|
| Power: 3.9 W | • Die-cast aluminum or 316 marine grade stainless steel (SS finish) | • 120V direct wiring, no driver needed |
| Lumens: Up to 68 | • Fits into 2" X 4" J-Box with minimum inside dimensions of 3"x2"x2" | • Cool to the touch |
| CRI: 85 | • IP66, wet location rated for indoor and outdoor installations | • Dimmable with electronic low voltage dimmer |
| Rated Life: 40,000 hours | • 5 year WAC warranty (lifetime warranty for SS finish) | • Replacable LED module |

STEP | FUNCTIONAL

System	Color	Finish
WL-LED100 <i>Horizontal Scoop, 120V</i>	C White 3000K	SS Stainless Steel
WL-LED100F <i>Horizontal Scoop, 277V</i>	AM Amber 610nm	BK Black
WL-LED200 <i>Vertical Scoop, 120V</i>	RD Red 640nm	WT White
WL-LED200F <i>Vertical Scoop, 277V</i>	BL Blue 450nm	BN Brushed Nickel
		BZ Bronze

Example: **WL-LED100F-C-SS**

Turtle Friendly

In coastal areas, bright steplights often times attract marine life such as baby sea turtles, leading them away from the ocean by making them think it is the moon. Save the sea turtles by using amber or red steplights.



Spacing Recommendations for Optimal Light Distribution

Corridors / Hallways

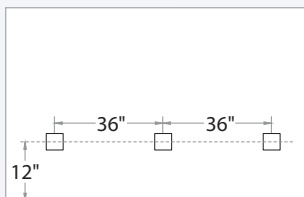

Stairs - Wall Mount

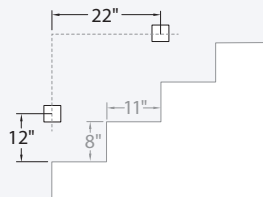

Stairs - Step Mount

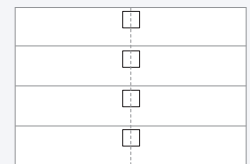

Mount in center of stair as close to the next tread as possible.
For best results use one light for every step.

LEDme® Steplight - Rectangle Trimless NEW



LED100TR
White finish

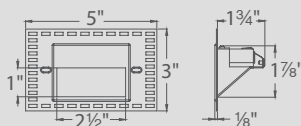

LED200TR
White Finish

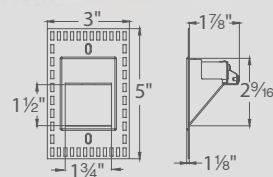

- | | | |
|--|--|---|
| <p>Power: 3.3 W</p> <p>Lumens: Up to 72</p> <p>CRI: 85</p> <p>Rated Life: 40,000 hours</p> | <ul style="list-style-type: none"> • Two-part construction for neat installation • Can be painted to match the color of wall or treads • 120V direct wiring, no driver needed • Fits into 2" X 4" J-Box with minimum inside dimensions of 3"x2"x2" | <ul style="list-style-type: none"> • No heat radiation • Dimmable with electronic low voltage dimmer • Replaceable LED module • 5 year WAC warranty |
|--|--|---|

System	Color	Finish
WL-LED100TR <i>Trimless Horizontal Scoop</i>	C White 3000K	WT White
	AM Amber 610nm	
	RD Red 640nm	
	BL Blue 450nm	
WL-LED200TR <i>Trimless Vertical Scoop</i>		

Example: **WL-LED100TR-AM-WT**

Light that helps people sleep

Bright environments late at night are known to disrupt sleep, but the amber or red color steplights filter shorter wavelengths in the visible spectrum, helping our bodies maintain their physiological rhythm.



Spacing Recommendations for Optimal Light Distribution

Corridors / Hallways

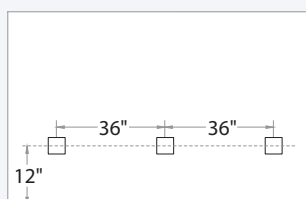

Stairs - Wall Mount

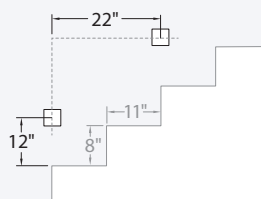

Stairs - Step Mount

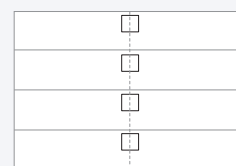

Mount in center of stair as close to the next tread as possible.
For best results use one light for every step.



Featured Product: **WL-LED310-C-BN**

LEDme® Step light - Round



LED300
Brushed Nickel finish

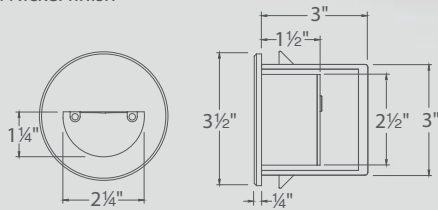

LED310
Bronze Finish

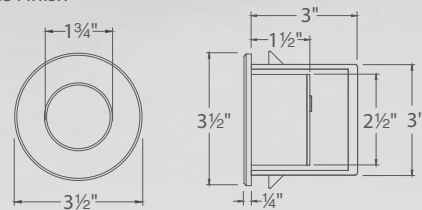

Power: 3.9 W
Lumens: Up to 115
CRI: 85
Rated Life: 40,000 hours

- Die-cast aluminum construction
- IP66, wet location rated for indoor and outdoor installations
- Supplied with a junction box for a custom recessed installation
- 120V direct wiring, no driver needed

- No heat radiation
- Replaceable LED module
- 5 year WAC warranty

System	Color	Finish
WL-LED300 Scoop	C White 3000K	WT White
	AM Amber 610nm	
WL-LED310 Open	RD Red 640nm	BN Brushed Nickel
	BL Blue 450nm	BZ Bronze

Example: WL-LED300-C-BN

Wayfinding

LEDme® step and wall lights can color-code pathways to indicate certain direction or the designation of the space.

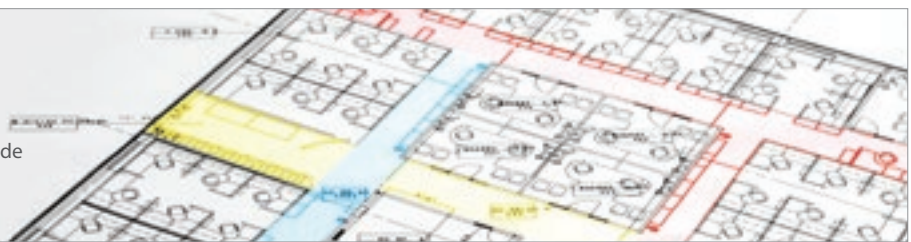

Spacing Recommendations for Optimal Light Distribution

Corridors / Hallways

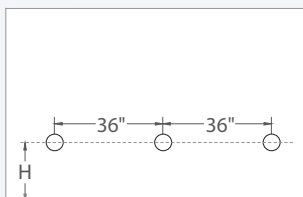

LED300	H: 12"
LED310	H: 6"

Stairs - Wall Mount

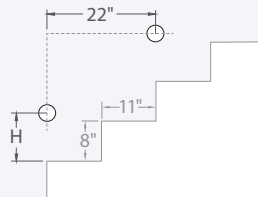

LED300	H: 12"
LED310	H: 6"

Stairs - Step Mount

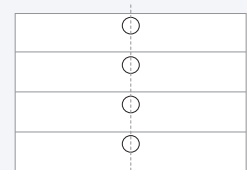

Mount in center of stair as close to the next tread as possible.
For best results use one light for every step.

Tesla 2" Energy Star®

Power: 14.5W
 Lumens: Up to 694
 Compare To: 50W MR16
 CRI: 85
 Dimming: 100% – 10% (120V only)
 Rated Life: 50,000 hours



- Energy Star® Qualified
- 2" aperture
- Interchangeable reflectors for changing beam spreads
- 9° cut-off angle

Model	Beam	Color Temp	Finish
HR-2LD-ET109	S 16.5°	27 2700K	BN Brushed Nickel CB Copper Bronze WT White
	N 30°	W 3000K	
	F 53°	35 3500K	
		C 4000K	

Example: **HR-2LD-ET109F-W-CB**

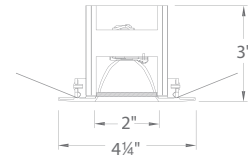

Tesla 2"

Power: 14.5W
 Lumens: Up to 616
 Compare To: 50W MR16
 CRI: 85
 Dimming: 100% – 10% (120V only)
 Rated Life: 50,000 hours

RECESSED | FUNCTIONAL



- 2" aperture
- Interchangeable reflectors for changing beam spreads
- 30° visual cut-off for glare control
- Adjustable fixtures are ideal for sloped ceiling applications
- Shower light is wet location listed

Model	Trim Type	Beam	Color Temp	Finish
HR-2LED-T109	Round Downlight	S 15° N 26° F 45°	27 2700K W 3000K 35 3500K C 4000K	BN Brushed Nickel CB Copper Bronze WT White
HR-2LED-T709	Square Downlight			
HR-2LED-T309	Round 0°- 30° Adjustable			
HR-2LED-T409	Round 30°- 45° Adjustable			
HR-2LED-T209	Round Shower Light	N 26°		
HR-2LED-T509N	Square Wall Wash	n/a		

Example: **HR-2LED-T709F-W-WT**

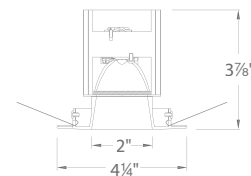

Example dimensions for HR-2LED-T709
 overall height may vary with trim type

Housings (Order Separately)

Model	Installation	Rating	Volt	H	W	L
HR-2LED-H09D-ICA	New Construction	IC-Rated – Airtight	120V	5 1/2"	15 - 24 1/2"	15 7/8"
HR-2LED-R09D-A*	Remodel	Non-IC – Airtight	120V	5 7/8"	13 3/4"	3 5/8"
HR-2LED-H09-HICA	New Construction	IC-Rated – Airtight	277V	5 1/2"	15 - 24 1/2"	15 7/8"

*Not compatible with T309, T409 or T509.

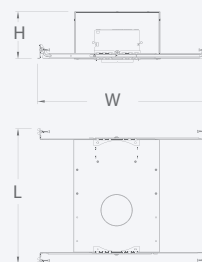

Replacement Modules

2700K	LXS8-PW27
3000K	LXS8-PW30
3500K	LXS8-PW35
4000K	LXS8-PW40

Interchangeable Reflectors

Spot	SL-REF-LUX10-15
Narrow Flood	SL-REF-LUX10-25
Flood	SL-REF-LUX10-40

Tesla 3.5" Energy Star®

Power: 21.5W
 Lumens: Up to 1002
 Compare To: 75W MR16
 CRI: 85
 Dimming: 100% – 15% (120V only)
 Rated Life: 50,000 hours



- Energy Star® Qualified
- 3.5" aperture
- Interchangeable reflectors for changing beam spreads
- 44° cut-off angle for glare control

Model	Beam	Color Temp	Finish
HR-3LD-ET118	F 40°	27 2700K	BN Brushed Nickel
		W 3000K	CB Copper Bronze
		35 3500K	WT White
		C 4000K	

Example: **HR-3LD-ET118F-W-WT**

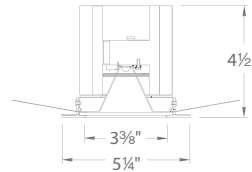

Tesla 3.5"

Power: 21.5W
 Lumens: Up to 869
 Compare To: 75W MR16
 CRI: 85
 Dimming: 100% – 15% (120V only)
 Rated Life: 50,000 hours

- 3.5" aperture
- Interchangeable reflectors for changing beam spreads
- 35° visual cut-off for glare control
- Adjustable fixtures are ideal for sloped ceiling applications
- Shower light is wet location listed



RECESSED | FUNCTIONAL

Model	Trim Type	Beam	Color Temp	Finish
HR-3LED-T118	Round Downlight	S 15° N 28° F 50°	27 2700K W 3000K 35 3500K C 4000K	HZ/BN Haze/Brushed Nickel
				HZ/CB Haze/Copper Bronze
				HZ/WT Haze/White
				SB/BN Specular Black/Brushed Nickel
HR-3LED-T318	Round 0° - 30° Adjustable	S 15° N 28° F 50°	27 2700K W 3000K 35 3500K C 4000K	SB/BN Specular Black/Brushed Nickel
				SB/CB Specular Black/Copper Bronze
				SB/WT Specular Black/White
				WT White/White
HR-3LED-T718	Square Downlight	S 15° N 28° F 50°	27 2700K W 3000K 35 3500K C 4000K	BN Brushed Nickel/Brushed Nickel
				CB Copper Bronze/Copper Bronze
				WT White/White
				WT White/White
HR-3LED-T418	Round 30° - 45° Adjustable	S 15° N 28° F 50°	27 2700K W 3000K 35 3500K C 4000K	BN Brushed Nickel
				CB Copper Bronze
				WT White
				WT White
HR-3LED-T218	Round Shower Light	N 28°	35 3500K C 4000K	
HR-3LED-T618	Round Pinhole, 0° - 30° Adjustable	N 28°	35 3500K C 4000K	
HR-3LED-T518N	Square Wall Wash	n/a		

Example: **HR-3LED-T118S-27-HZ/WT**

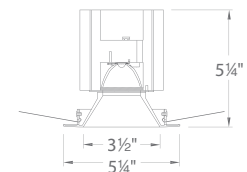

Example dimensions for HR-3LED-T118
 overall height may vary with trim type

Housings (Order Separately)

Model	Installation	Rating	Volt	H	W	L
HR-3LED-H18D-ICA	New Construction	IC-Rated – Airtight	120V	6"	15 - 24 1/2"	16 3/4"
HR-3LED-H18D-A*	New Construction	Non-IC – Airtight	120V	6 5/8"	15 - 24 1/2"	8 1/4"
HR-3LED-H18D-EMICA	New Construction, Emergency Backup Battery	IC-Rated – Airtight	120V	6"	15 - 24 1/2"	16 3/4"
HR-3LED-R18D-A*	Remodel	Non-IC – Airtight	120V	6 5/8"	13 3/4"	4 3/8"
HR-3LED-H18-HICA	New Construction	IC-Rated – Airtight	277V	6"	15 - 24 1/2"	16 3/4"

*Not compatible with T318, T418, T518 or T618

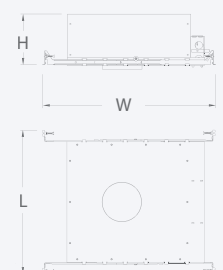

LEDme® 1" – Integral Driver and Housing

Power: 4 W
 Lumens: Up to 201
 Compare To: 20W MR11
 CRI: 85
 Dimming: 100% – 10%
 Rated Life: 50,000 hours



Model		Color Temp	Finish
HR-LED211E	Round Downlight	27 2700K	BN Brushed Nickel
HR-LED251E	Square Downlight	W 3000K	GM Gun Metal
HR-LED212E	Round Adjustable	35 3500K	WT White
HR-LED252E	Square Adjustable	C 4500K	

Replacement Modules

2700K	RM1X3-27-DL
3000K	RM1X3-30-DL
3500K	RM1X3-35-DL
4500K	RM1X3-45-DL

Example: **HR-LED211E-27-WT**

New Construction Configuration

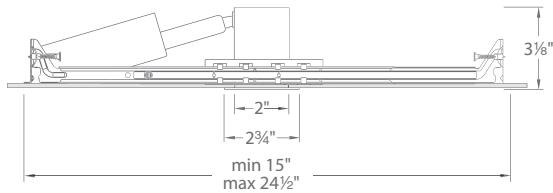

Remodel Configuration

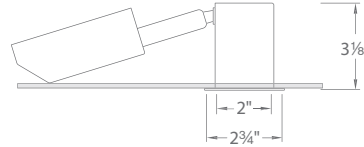

RECESSED | FUNCTIONAL

LEDme® 1" – Remote Driver

Power: 3 W
 Lumens: Up to 201
 Compare To: 20W MR11
 CRI: 85
 Dimming: 100% – 10%
 Rated Life: 50,000 hours



Model		Color Temp	Finish
HR-LED231R	Round Downlight	27 2700K	BN Brushed Nickel
HR-LED271R	Square Downlight	W 3000K	GM Gun Metal
HR-LED232R	Round Adjustable	35 3500K	WT White
HR-LED272R	Square Adjustable	C 4500K	

Replacement Modules

2700K	RM1X3-27-DL
3000K	RM1X3-30-DL
3500K	RM1X3-35-DL
4500K	RM1X3-45-DL

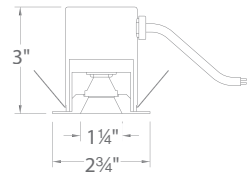

Example: **HR-LED232R-27-GM**

LEDme® Class 2 Electronic Drivers

Model #	Dimming	Watt	Dimensions
LD-700MA03-EDIM-IS	Yes	3W	L: 5 5/8" W: 1 5/8" H: 1 1/8"
LD-700MA09-EDIM-IS	Yes	9W	L: 7 1/8" W: 3 1/8" H: 1 5/8"
LED-700MA12-P	No	12W	L: 5" W: 3 1/8" H: 1 5/8"

ONLY for home-run wiring.

Works in BOTH series wiring and home-run wiring.

Multiple Terminal Block

Model #	Dimensions
MTB-01	L: 3 1/4" W: 1 3/4" H: 7/8"

Accommodates up to 6 output connections.

LEDme® 3"

Power: 5.8W (IC-Rated), 8W (Non-IC)
Lumens: Up to 329 (IC-Rated), 539 (Non-IC)
Compare To: 35W MR16
CRI: 85
Dimming: 100% – 10%
Rated Life: 50,000 hours

- Super low profile trim at less than 1/8" thick
- Deep regression of LEDs produces a very low glare with 40° visual cut-off
- Shower light is wet location listed



Featured Product: **HR-LED331-WT**

RECESSED | FUNCTIONAL

Model	Trim Type	Finish
HR-LED311	Round Downlight	BK/BN Black/Brushed Nickel
HR-LED351	Square Downlight	BK/WT Black/White
HR-LED321	Round Baffle	WT/WT White/White
HR-LED331	Round Shower Light	CH Chrome
HR-LED371	Square Shower Light	WT White

Example: **HR-LED351-BK/WT**

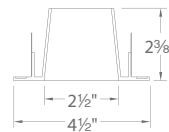

Housings (Order Separately)

Installation	Model	Rating	Color Temp	H	W	L
New Construction	HR-LED309	NIC IC-Rated	27 2700K	5 1/8"	15 - 24 1/2"	6 3/4"
		N Non-IC	35 3000K			
Remodel	HR-LED309	RIC IC-Rated	35 3500K	5 1/8"	15 - 24 1/2"	3 3/4"
		R Non-IC	C 4500K			

Example: **HR-LED309-NIC-27**

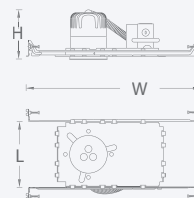

Replacement Modules

2700K	RM3X3-27-DL
3000K	RM3X3-30-DL
3500K	RM3X3-35-DL
4500K	RM3X3-45-DL

LEDme® 4" Energy Star®

Power: 11 W (IC-Rated), 15W (Non-IC)
Lumens: Up to 1003 (Non-IC), 678 (IC-Rated)
Compare To: 75W MR16 (Non-IC), 50W MR16 (IC)
CRI: 85
Dimming: 100% – 10%
Rated Life: 50,000 hours



- Energy Star® Rated
- Super low profile trim at less than 1/8" thick
- Deep regression of LEDs produces very low glare with 40° visual cut-off
- Shower light is wet location listed

Trim

Model	Trim Type	Finish
HR-LED411	Round Downlight	BK/BN Black/Brushed Nickel
HR-LED451	Square Downlight	BK/WT Black/White
HR-LED421	Round Baffle	WT/WT White/White
HR-LED431	Round Shower Light	CH Chrome
HR-LED471	Square Shower Light	WT White

Example: **HR-LED421-BK/WT**

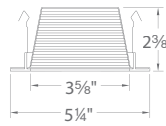

LEDme® 4" Invisible Trim™ Energy Star®

Power: 11 W (IC-Rated), 15W (Non-IC)
Lumens: Up to 1003 (Non-IC), 678 (IC-Rated)
Compare To: 75W MR16 (Non-IC), 50W MR16 (IC)
CRI: 85
Dimming: 100% – 10%
Rated Life: 50,000 hours



- Trim sits flush to ceiling for a sophisticated architectural look
- Energy Star® Rated
- Super low profile trim at less than 1/8" thick
- Deep regression of LEDs produces very low glare with 40° visual cut-off
- Shower light is wet location listed

RECESSED | FUNCTIONAL

Invisible Trim™

Model	Trim Type	Finish
HR-LED411TL	Round Downlight	BK/BN Black/Brushed Nickel
HR-LED451TL	Square Downlight	BK/WT Black/White
HR-LED421TL	Round Baffle	WT/WT White/White

Example: **HR-LED421TL-BK/WT**

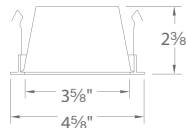

Housings include a spackle ring to permit a stable finished installation within a drywall ceiling



Housings (Order Separately)

Installation	Model	Rating	Invisible Trims Only	Color Temp	H	W	L
New Construction	HR-LED418	NIC IC-Rated	RO Round	27 2700K	5 1/2"	15 - 24 1/2"	6 3/4"
		N Non-IC		W 3000K			
Remodel	HR-LED418	RIC IC-Rated	SQ Square	35 3500K	5 5/8"	11 7/8"	7 1/8"
		R Non-IC		C 4500K			
New Construction Emergency Backup Battery	HR-LED418	N Non-IC	RO Round	27-EM 2700K	5 1/2"	15 - 24 1/2"	6 3/4"
				W-EM 3000K			
				35-EM 3500K			
				C-EM 4500K			

Replacement Modules

2700K	RM6X3-27-DL
3000K	RM6X3-30-DL
3500K	RM6X3-35-DL
4500K	RM6X3-45-DL

Example: **HR-LED418-NIC-27** (Trim) or **HR-LED418-N-ROW-EM** (Invisible Trim)

Plana 6" LED

Commercial Grade Recessed Downlight

- Long life with low power consumption
50,000 hour life
- UL Listed for Wet Location
- Dimming capabilities
100% – 10% ELV dimming for 120V only
0 - 10V dimming for 120V and 277V



Round Downlight Trim

Model	Finish	Reflector/Trim
WR-6R1LD-T	HZ/WT	<i>Haze/White</i>
	SC/WT	<i>Specular Clear/White</i>
	WT/WT	<i>White/White</i>

Example: **WR-6R1LD-T-WT/WT**

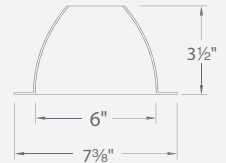

High Output LED

High Brightness

LED Module: Bridgelux
Power: 29 W
Lumens: Up to 1565
Compares To: 120W PAR38
CRI: 85

Recommended Mounting Height

Distance (ft)	Light Level (fc)	Beam Diameter (ft)
12	26.7	7.3
14	19.6	8.6
16	15.0	9.8
18	11.9	11.0

High Output Housings

Installation	Model	Voltage	Color Temp
<i>New Construction</i>	WR-6RTL	30	120V 27T 2700K
			3000K
		30H	277V 35T 3500K
			40T 4000K
<i>New Construction, Emergency Backup Battery</i>	WR-6RTL	30	120V 27EM 2700K
			3000K
		30H	277V 35EM 3500K
			40EM 4000K

Example: **WR-6RTL30H-27T**

Replacement Modules

2700K	BXRA-27E2000
3000K	BXRA-30E2000
3500K	BXRA-35E2000
4000K	BXRA-40E2200

High CRI LED

Color quality

LED Module: Xicato
Power: 22 W
Lumens: Up to 735
Compares To: 50W PAR30
CRI: 95

Recommended Mounting Height

Distance (ft)	Light Level (fc)	Beam Diameter (ft)
8	39.3	5.8
10	25.2	7.3
12	17.5	8.7
14	12.8	10.2

High CRI Housings

Installation	Model	Voltage	Color Temp
<i>New Construction</i>	WR-6RTL	30-X	120V 27T 2700K
			3000K
		30H-X	277V 35T 3500K
			40T 4000K
<i>New Construction, Emergency Backup Battery</i>	WR-6RTL	30-X	120V 27EM 2700K
			3000K
		30H-X	277V 35EM 3500K
			40EM 4000K

Example: **WR-6RTL30H-X-27T**

Replacement Modules

2700K	XSM9527-1300-C
3000K	XSM9530-1300-C
3500K	XSM9535-1300-C
4000K	XSM9540-1300-C

4" LED Precision Modules Energy Star® **NEW**

Retractable spot lights adjustable up to 90° from vertical

- Power:** 16W / light
 - Lumens:** Up to 1100 / light
 - Compare To:** 75W MR16
 - CRI:** 85
 - Dimming:** 100% – 10% (120V only)
 - Rated Life:** 50,000 hours
 - Input Voltage:** 120V - 277V
- Energy Star® rated
 - ETL & cETL listed
 - Non-IC housings*
 - Accepts one replacement lens

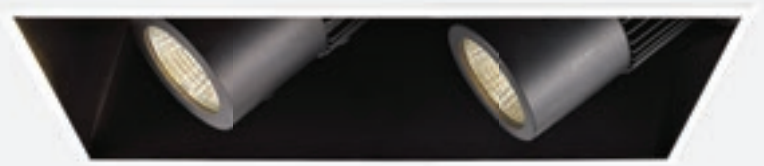

1 Light



Shown with Trim

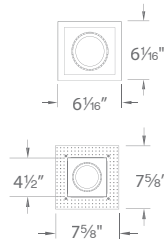

Trims (Order Housings Separately)

Model	Trim	Finish
MT-4LD116T	Trim	WT White
MT-4LD116TL	Invisible Trim™	

Example: **MT-4LD116T-WT**

2 Lights



Shown with Invisible Trim™

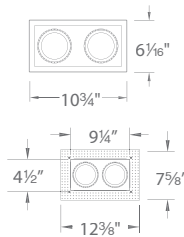

Model	Trim	Finish
MT-4LD216T	Trim	WT White
MT-4LD216TL	Invisible Trim™	

Example: **MT-4LD216T-WT**

3 Lights



Shown with Trim

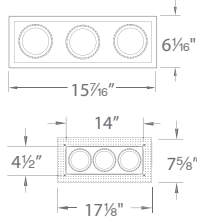

Model	Trim	Finish
MT-4LD316T	Trim	WT White
MT-4LD316TL	Invisible Trim™	

Example: **MT-4LD316T-WT**

4 Lights



Shown with Invisible Trim™

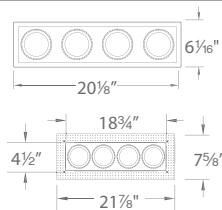

Model	Trim	Finish
MT-4LD416T	Trim	WT White
MT-4LD416TL	Invisible Trim™	

Example: **MT-4LD416T-WT**

4 Lights (2 x 2)

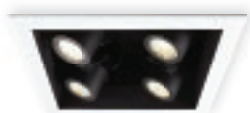

Shown with Trim

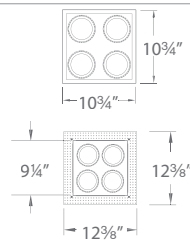

Model	Trim	Finish
MT-4LD226T	Trim	WT White
MT-4LD226TL	Invisible Trim™	

Example: **MT-4LD226T-WT**

RECESSED | FUNCTIONAL

Housings (Order Separately)

	Model	Beam	Color Temp	Rating	Finish	H	W	L
1 Light	MT-4LD116N	S 20° F 40°	27 2700K 30 3000K 35 3500K 40 4000K	Non-IC	BK Black	6"	14 ¹⁵ / ₁₆ "	7 ¹ / ₈ "
2 Lights	MT-4LD216N					6"	19 ⁵ / ₈ "	7 ¹ / ₈ "
3 Lights	MT-4LD316N					6"	24 ¹⁵ / ₁₆ "	7 ¹ / ₈ "
4 Lights	MT-4LD416N					6"	29"	7 ¹ / ₈ "
4 Lights (2 x 2)	MT-4LD226N					6"	20 ⁷ / ₁₆ "	7 ¹ / ₈ "

Example: **MT-4LD316N-S27-BK**

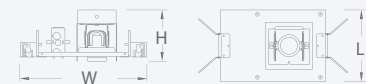

Mini LED Multiple Spots **NEW**

Integral housing adjustable recessed spot lights

- Power:** 11W / light
 - Lumens:** Up to 755 lm / light
 - Compare To:** 50W MR16
 - CRI:** 85
 - Color Temp:** 3000K
 - Dimming:** 100 - 10%
 - Rated Life:** 60,000 hours
- One complete unit includes housing & trim
 - ETL & cETL listed
 - All housings are Non-IC & Airtight



1 Light

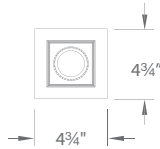
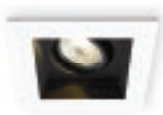

Model	Installation	Finish	Trim/Reflector
MT-3LD111NA-F30	<i>New Construction</i>	BK	<i>White/Black</i>
MT-3LD111R-F30	<i>Remodel</i>	WT	<i>White/White</i>

Example: **MT-3LD111NA-F30-BK**

New Construction Housing

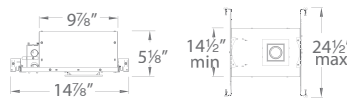

Remodel Housing

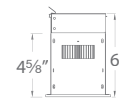

Housing & Trim are both included

2 Lights

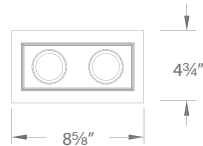

Model	Installation	Finish	Trim/Reflector
MT-3LD211NA-F30	<i>New Construction</i>	BK	<i>White/Black</i>
MT-3LD211R-F30	<i>Remodel</i>	WT	<i>White/White</i>

Example: **MT-3LD211NA-F30-BK**

New Construction Housing

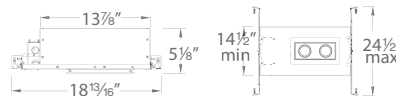

Remodel Housing

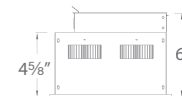

Housing & Trim are both included

3 Lights

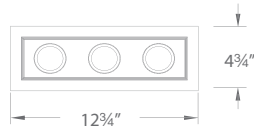

Model	Installation	Finish	Trim/Reflector
MT-3LD311NA-F30	<i>New Construction</i>	BK	<i>White/Black</i>
MT-3LD311R-F30	<i>Remodel</i>	WT	<i>White/White</i>

Example: **MT-3LD311NA-F30-BK**

New Construction Housing

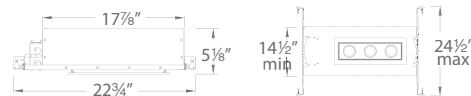

Remodel Housing

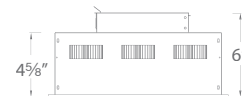

Housing & Trim are both included

*Non-IC housings require 3" of clearance from insulation on all sides. 1/2" of sheetrock should be considered when planning for housing installation.

RECESSED | FUNCTIONAL

Tesla LED Multiple Spots NEW

High brightness adjustable luminaires



- Power:** 22.5W / light
 - Lumens:** Up to 1515 lm / light
 - Compare To:** 75W MR16
 - CRI:** 85
 - Dimming:** 100% – 15% ELV dimming for 120V only
0 - 10V dimming for 120V and 277V
 - Rated Life:** 50,000 hours
 - Input Voltage:** 120V - 277V
- Energy Star® rated
 - ETL & cETL listed
 - Accepts one lens



1 Light



Shown with Trim

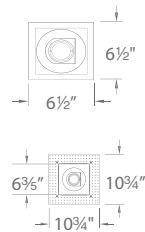

Trims (Order Housings Separately)

Model	Beam	Color Temp	Finish	Trim/Module
MT-5LD125T Trim	S 25°	27 2700K	WT	White/ White
MT-5LD125TL Invisible Trim™	F 40°	30 3000K		
		35 3500K		
		40 4000K		

Example: **MT-5LD125T-S30-WT**

2 Lights



Shown with Invisible Trim™

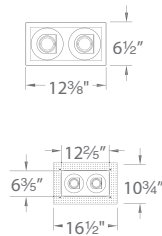

Model	Beam	Color Temp	Finish	Trim/Module
MT-5LD225T Trim	S 25°	27 2700K	WT	White/ White
MT-5LD225TL Invisible Trim™	F 40°	30 3000K		
		35 3500K		
		40 4000K		

Example: **MT-5LD225T-S30-WT**

3 Lights



Shown with Trim

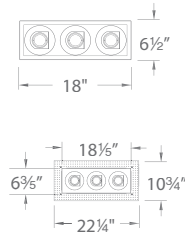

Model	Beam	Color Temp	Finish	Trim/Module
MT-5LD325T Trim	S 25°	27 2700K	WT	White/ White
MT-5LD325TL Invisible Trim™	F 40°	30 3000K		
		35 3500K		
		40 4000K		

Example: **MT-5LD325T-S30-WT**

4 Lights



Shown with Invisible Trim™

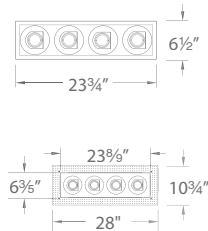

Model	Beam	Color Temp	Finish	Trim/Module
MT-5LD425T Trim	S 25°	27 2700K	WT	White/ White
MT-5LD425TL Invisible Trim™	F 40°	30 3000K		
		35 3500K		
		40 4000K		

Example: **MT-5LD425T-S30-WT**

4 Lights (2 x 2)



Shown with Trim

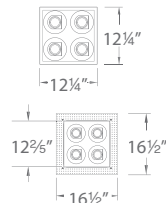

Model	Beam	Color Temp	Finish	Trim/Module
MT-5LD445T Trim	S 25°	27 2700K	WT	White/ White
MT-5LD445TL Invisible Trim™	F 40°	30 3000K		
		35 3500K		
		40 4000K		

Example: **MT-5LD445T-S30-WT**

New Construction Housings (Order Separately)

	Model	Rating	H	W	L
1 Light	MT-5LD125H-NA	Non-IC - Airtight	5"	15" - 25"	16 1/3"
2 Lights	MT-5LD225H-NA		5"	15" - 25"	22"
3 Lights	MT-5LD325H-NA		5"	15" - 25"	27 3/4"
4 Lights	MT-5LD425H-NA		5"	15" - 25"	34 3/4"
4 Lights (2 x 2)	MT-5LD445H-NA		5"	15" - 25"	23 5/8"

Example: **MT-5LD225H-NA**

Color Lens	LENS-16	AMB Amber	Frosted Lens Spread Lens Beam Elongating Honeycomb Louver	LENS-16-FR LENS-16-SPR LENS-16-BEL LENS-16-HCL
Dichroic Color Lens	LENS-16-DIC	BLU Blue		
		GRN Green		
		RED Red		
		YEL Yellow		

LEDme® Multiple Spot – Trim and Invisible Trim™

Compact adjustable luminaires

	<i>IC</i>	<i>Non-IC</i>
Power:	11 W / light	15W / light
Lumens:	Up to 764	
Compare To:	50W MR16	
CRI:	85	
Dimming:	100% – 10%	
Rated Life:	50,000 hours	

- Invisible Trim™ sits flush to ceiling
- Trims have low profile at less than 1/8" thick
- Available for IC and Non-IC installations



1 Light



Shown with Trim

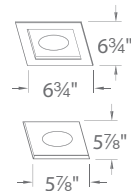

Trims (Order Housings Separately)

Model	Finish
MT-LED118 <i>Trim</i>	WT <i>White</i>
MT-LED118TL <i>Invisible Trim</i>	

Example: **MT-LED118-WT**

2 Lights



Shown with Invisible Trim™

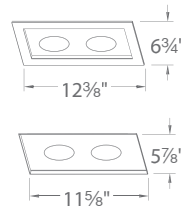

Model	Finish
MT-LED218 <i>Trim</i>	WT <i>White</i>
MT-LED218TL <i>Invisible Trim</i>	

Example: **MT-LED218TL-WT**

3 Lights



Shown with Trim

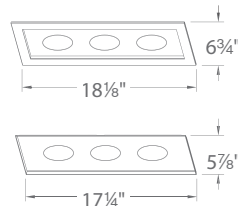

Model	Finish
MT-LED318 <i>Trim</i>	WT <i>White</i>
MT-LED318TL <i>Invisible Trim</i>	

Example: **MT-LED318-WT**

4 Lights



Shown with Invisible Trim™

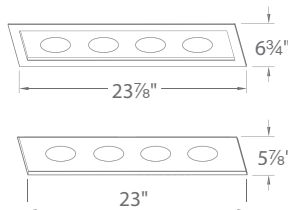

Model	Finish
MT-LED418 <i>Trim</i>	WT <i>White</i>
MT-LED418TL <i>Invisible Trim</i>	

Example: **MT-LED418TL-WT**

4 Lights (2 x 2)



Shown with Trim

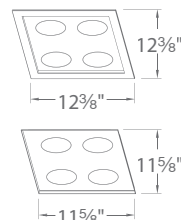

Model	Finish
MT-LED228 <i>Trim</i>	WT <i>White</i>
MT-LED228TL <i>Invisible Trim</i>	

Example: **MT-LED228-WT**

Housings (Order Separately)

	Model	Beam	Color Temp	Rating	Finish
1 Light	MT-LED118	S 10° F 25°	27 2700K	HS <i>IC-Rated</i> HSNIC <i>Non-IC</i>	WT <i>White</i>
2 Lights	MT-LED218		WW 3000K		
3 Lights	MT-LED318		35 3500K		
4 Lights	MT-LED418		CW 4500K		
4 Lights (2 x 2)	MT-LED228				

Example: **MT-LED218S-CWHS-WT**

Replacement Modules

2700K	RM6X3-27-DL
3000K	RM6X3-30-DL
3500K	RM6X3-35-DL
4500K	RM6X3-45-DL

W Track System - Surface mount

Description: Heavy duty architectural grade track with two independently controllable circuits and stem or cable suspensions
Power per Circuit: 1920 W max (120V), 4432 W max (277V)
Operating Current: Each circuit is rated 20A (2 x 20A = 40A max)

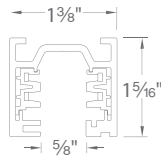

120V Track Sections

Model	Length	Finish
WT 120V	4 4'	BK Black
WHT 277V	8 8'	PT Platinum
	12 12'	WT White

Example: **WHT4-PT**

Each section includes two matching end caps.

Accessories

Model	Volt	Finish	Description
WEDL WHEDL	120V 277V	BK PT WT	Direct wiring through ceiling. Polarity on left side of track.
WEDR WHEDR	120V 277V	BK PT WT	Direct wiring through ceiling. Polarity on right side of track.
WPC WHPC	120V 277V	BK PT WT	Join two sections of track with electrical continuity.
WIC WHIC	120V 277V	BK PT WT	Power entry point at the connection of two tracks.
WFC WHFC	120V 277V	BK PT WT	Transition from wall-to-wall, wall-to-ceiling, or ceiling-to-ceiling. Power feedable.
CP	120V 277V	BK PT WT	Covers a standard 4" octagonal box.

"L" Connector Left Polarity	WLLC WHLLC	120V 277V	BK PT WT	Join 2 track sections to make power feedable 90° left polarity turns.
"L" Connector Right Polarity	WRLC WHRLC	120V 277V	BK PT WT	Join 2 track sections to make power feedable 90° right polarity turns.
"T" Connector Left	WLTC WHLTC	120V 277V	BK PT WT	Join 3 track sections. Power feedable. Polarity on outside edge.
"T" Connector Right	WRTC WHRTC	120V 277V	BK PT WT	Join 3 track sections. Power feedable. Polarity on inside edge.
"X" Connector	WXC WHXC	120V 277V	BK PT WT	Join 4 track sections. Power feedable.

Track Current Limiter

Model	Volt	Rating	Finish	Description
WEDL WHEDL	120V 277V	1A 1 Amp 2A 2.5Amp 5A 5 Amp	BK PT WT	Assures compliance to California Title 24 or ASHRAE 90.1 requirements
WEDR WHEDR	120V 277V	7A 7.5Amp 10A 10Amp 12A 12Amp	BK PT WT	

TRACK | FUNCTIONAL

Suspension

Model	Length	Finish	Description
WMSP	6 6"	BK PT WT	Power feed to connect with a Live End or any Joiner/Feeder. May be field cut.
	12 12"		
	24 24"		
	36 36"		
	48 48"		
WMFP	48 48"	BK PT WT	Flexible power feed to connect with a Live End or any Joiner/Feeder. Recommended for use with Cable Suspensions. May be field cut.
	96 96"		
WMT-X	6 6"	BK PT WT	Use to extend track from the ceiling. May be field cut.
	12 12"		
	24 24"		
	36 36"		
WMT-TB	48 48"	BK PT WT	Extend track from drop ceilings. May be field cut.
	96 96"		
WMT	XS6 6"	BK PT WT	Use to extend track from a sloped ceiling. May be field cut.
	XS12 12"		
	XS24 24"		
	XS36 36"		
	XS48 48"		
WMST	XS48 48"	BK PT WT	Extend track from a sloped ceiling. May be field cut.
	XS96 96"		
WMST-X	48 48"	BK PT WT	Extend track from the ceiling. May be field cut.
WMST-TB	96 96"		

Suspension Accessories

Model	Finish
WMT-RT	PT
WMPC	BK PT WT
WMED	BK PT WT
WMIC	BK PT WT
WMLC	BK PT WT
WMTC	BK PT WT
WMXC	BK PT WT

W Track System - Recessed

Description: Architectural grade track with flangeless option with two independently controllable circuits and stem or cable suspensions
Power per Circuit: 1920 W max (120V), 4432 W max (277V)
Operating Current: Each circuit is rated 20A (2 x 20A = 40A max)

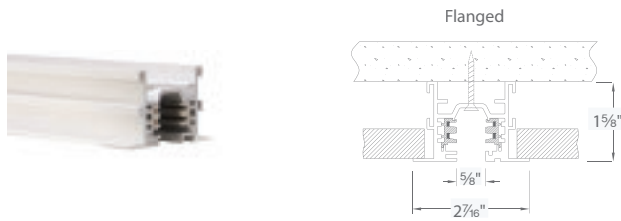

Flanged Track Sections

Model	Length	Track Type	Finish
WT 120V	4 4'	RT Recessed Flanged	BK Black
WHT 277V	8 8'		PT Platinum
	12 12'		WT White

Example: **WHT8-RT-WT**

Each section includes two matching end caps.

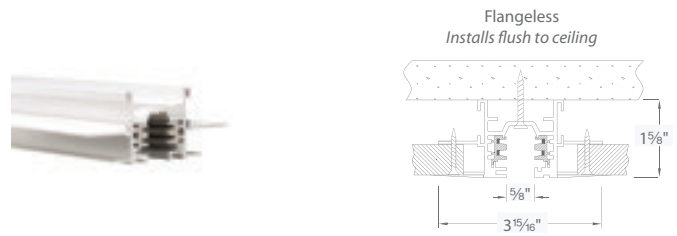

Flangeless Track Sections

Model	Length	Track Type	Finish
WT 120V	4 4'	RTL Recessed Flangeless	BK Black
WHT 277V	8 8'		PT Platinum
	12 12'		WT White

Example: **WT8-RTL-WT**

Each section includes two matching end caps.

Accessories

	Flanged	Flangeless	Model	Voltage	Flanged/Flangeless	Finish	Description
Live End Connector – Left polarity			WEDL	120V	RT Flanged RTL Flangeless	BK PT WT	Use for direct wiring through ceiling.
			WHEDL	277V			
Live End Connector – Right polarity			WEDR	120V	RT Flanged RTL Flangeless	BK PT WT	Use for direct wiring through ceiling.
			WHEDR	277V			
"I" Connector			WPC WHPC	120V 277V	RT Flanged	BK PT WT	Use to join two sections of track with electrical continuity.
"I" Power Connector			WIC WHIC	120V 277V	RT Flanged RTL Flangeless	BK PT WT	Power entry point at the connection of two tracks.
"L" Connector – Left			WLLC	120V	RT Flanged RTL Flangeless	BK PT WT	Use to join 2 track sections to make power feedable 90° left polarity turns.
"L" Connector – Right			WRLC	120V			Use to join 2 track sections to make a power feedable 90° right polarity turns.
"T" Connector – Left			WLTC	120V	RT Flanged RTL Flangeless	BK PT WT	Use to join 3 track sections. Power feedable. Polarity on outside edge.
			WHLTC	277V			Use to join 3 track sections. Power feedable. Polarity on inside edge.
"T" Connector – Right			WRTC	120V	RT Flanged RTL Flangeless	BK PT WT	Use to join 3 track sections. Power feedable. Polarity on outside edge.
			WHRTC	277V			Use to join 3 track sections. Power feedable. Polarity on inside edge.
"X" Connector			WXC WHXC	120V 277V	RT Flanged RTL Flangeless	BK PT WT	Use to join 4 track sections. Power feedable.

Track Current Limiter

	Model	Volt	Flanged/Flangeless	Rating	Finish	Description
Live end - Left			RT Flanged RTL Flangeless	1A 1 Amp 2A 2.5Amp 5A 5 Amp 7A 7.5Amp 10A 10Amp 12A 12Amp	BK PT WT	Easy to install and assures compliance to California Title 24 or ASHRAE 90.1 requirements
Live end - Right			RT Flanged RTL Flangeless	1A 1 Amp 2A 2.5Amp 5A 5 Amp 7A 7.5Amp 10A 10Amp 12A 12Amp	BK PT WT	Easy to install and assures compliance to California Title 24 or ASHRAE 90.1 requirements
	WHEDL	277V				
	WHEDR	277V				

Paloma | W Track **NEW**

- Exclusively designed for our 120V and 277V, W Track systems
- Available in LED, HID and Incandescent light sources
- Accommodates up to 1 filter lenses and 1 accessory
Color Lenses, Filter Lenses, Beam Control Accessories

- 360° horizontal rotation and 180° vertical aiming
- Threaded lens cap is easily removed for simple front load re-lamping
- Die-cast aluminum construction

LED512

Power: 12 W
Lumens: Up to 780
CBCP: Up to 3430
CRI: 85
Compare To: 50 W MR16
Dimming: 100% – 10% (120V only)
Rated Life: 50,000 hours

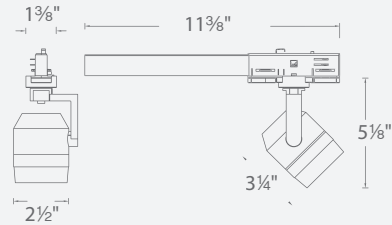

Track Type	System	Model	Beam	Color Temp	Finish
W Track	WTK 120V	LED512	S 19°	27 2700K	BK Black
	WHK 277V		N 24°	30 3000K	PT Platinum
			F 36°	35 3500K	WT White
				40 4000K	

Example: **WTK-LED512S-27-WT**

Lenses and Accessories

Color Lens	LENS-16	AMB Amber	Frosted Lens Spread Lens Beam Elongating Honeycomb Louver	LENS-16-FR LENS-16-SPR LENS-16-BEL LENS-16-HCL
Dichroic Color Lens	LENS-16-DIC	BLU Blue		
		GRN Green		
		RED Red		
		YEL Yellow		

LED522

Power: 23 W
Lumens: Up to 1310
CBCP: Up to 5780
CRI: 85
Compare To: 75W MR16
Dimming: 100% – 10% (120V only)
Rated Life: 50,000 hours

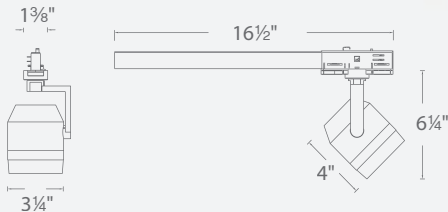

Track Type	System	Model	Beam	Color Temp	Finish
W Track	WTK 120V	LED522	S 19°	27 2700K	BK Black
	WHK 277V		N 24°	30 3000K	PT Platinum
			F 36°	35 3500K	WT White
				40 4000K	

Example: **WTK-LED522F-35-BK**

Lenses and Accessories

Color Lens	LENS-20	AMB Amber	Frosted Lens Spread Lens Beam Elongating Honeycomb Louver	LENS-20-FR LENS-20-SPR LENS-20-BEL LENS-20-HCL
		BLU Blue		
		GRN Green		
		RED Red		
		YEL Yellow		

LED532

Power: 28 W
Lumens: Up to 1755
CBCP: Up to 9770
CRI: 85
Compare To: 39W HID
Dimming: 100% - 10% (120V only)
Rated Life: 50,000 hours

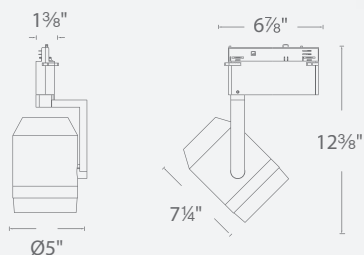

Track Type	System	Model	Beam	Color Temp	Finish
W Track	WTK 120V	LED532	S 16°	27 2700K	BK Black
	WHK 277V		N 25°	30 3000K	PT Platinum
			F 36°	35 3500K	WT White
				40 4000K	

Example: **WTK-LED532N-40-WT**

Lenses and Accessories

Color Lens	LENS-30	AMB Amber	Frosted Lens Spread Lens Beam Elongating Honeycomb Louver	LENS-30-FR LENS-30-SPR LENS-30-BEL LENS-30-HCL
		BLU Blue		
		GRN Green		
		RED Red		
		YEL Yellow		

LEDme® LOGOS | WTrack **NEW**

	LED23	LED40
Power:	23 W	40 W
Lumens:	Up to 1845	Up to 3080
CBCP:	Up to 18,049	Up to 24,767
Compare To:	39 W HID	70 W HID
CRI:	85	85
Dimming:	100% – 10%	100% – 10% (120V only)
Rated Life:	50,000 hours	50,000 hours



79
Lm/W

- Energy Star® Rated
- Single tool-free lens assembly for easy in field change of beam angle
- 360° horizontal and 180° vertical aiming
- Die-cast aluminum construction
- Dim with electronic low voltage (ELV) dimmer
- High performance with fixture efficacy up to 79Lm/W

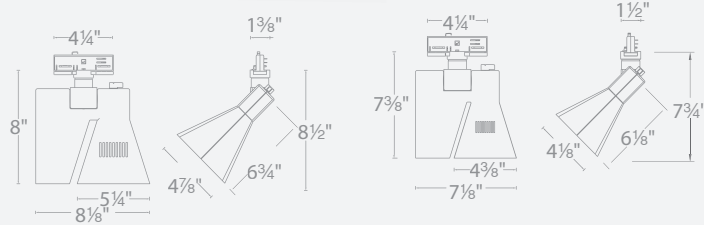

Track Type	System	Model	Beam	Color Temp	Finish
WTrack	WTK 120V	LED23 23W	S* 12°	27 2700K	BK Black PT Platinum WT White
		LED40 40W	N 24°	30 3000K	
	WHK 277V	F 36°	35 3500K		
		E 19° x 32° elliptical spread	40 4000K		

Example: **WTK-LED235-40-WT**
*not Energy Star Rated

Interchangeable Lens

	LED23	LED40
12°	OPH-9X3-12D	OPH-16X3-12D
24°	OPH-9X3-25D	OPH-16X3-25D
36°	OPH-9X3-40D	OPH-16X3-40D
19° x 32°	OPH-9X3-ELD	OPH-16X3-ELD

Replaceable LED Modules

2700K	RM-9X3-27	RM-16X3-27
3000K	RM-9X3-30	RM-16X3-30
3500K	RM-9X3-35	RM-16X3-35
4000K	RM-9X3-40	RM-16X3-40

TRACK | FUNCTIONAL

LEDme® ARGOS | WTrack **NEW**

Power:	25 W
Lumens:	Up to 1525
CBCP:	Up to 5868
CRI:	85
Dimming:	100% – 10%
Rated Life:	50,000 hours
Compare To:	39 W HID



61
Lm/W

- Energy Star® Rated
- 360° horizontal and 90° vertical hot aiming
- Dimming with electronic low voltage dimmer
- 50,000 hour rated life

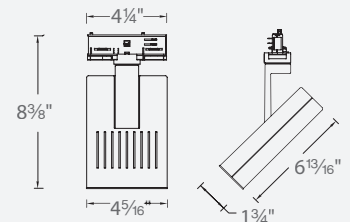

Track Type	System	Model	Beam	Color Temp	Finish
WTrack	WTK 120V	LED25	S 20°	27 2700K	BK Black PT Platinum WT White
			F 42°	30 3000K	
	WHK 277V		35 3500K		
			40 4000K		

Example: **WTK-LED255-27-BK**

Replaceable LED Modules

2700K	RM-10X3-27
3000K	RM-10X3-30
3500K	RM-10X3-35
4000K	RM-10X3-40

Interchangeable Lens

20°	OPH-10X3-20D
42°	OPH-10X3-42D

LED Wall Washer | W Track NEW

Power: 43 W
Lumens: Up to 2520
CRI: 85
Dimming: 100% - 10% (120V only)
Rated Life: 50,000 hours



60
 Lm/W

- Replaces halogen and fluorescent wall wash luminaires
- Die-cast aluminum construction
- Simple professional design
- Thin side profile
- 45° vertical tilt

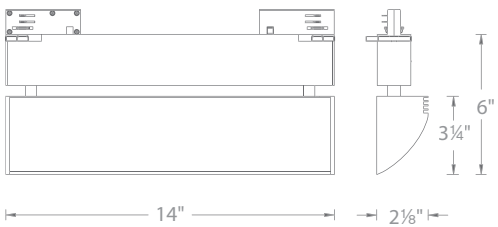

Average Footcandle Performance

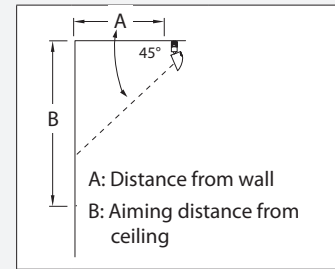

		A	
		3'	4'
B	1'	37	20
	2'	45	24
	4'	28	20
	6'	11	12

Track Type	System	Model	Color Temp	Finish
W Track	WTK 120V	LED42W	27 2700K	BK Black
			30 3000K	PT Platinum
	35 3500K		WT White	
	40 4000K			

Example: **WTK-LED42W-27-WT**

TRACK | FUNCTIONAL



LEDme® Reflex I W Track **NEW**

	LED17	LED27
Power:	17 W	27 W
Lumens:	Up to 1125	Up to 1900
CBCP:	Up to 3780	Up to 7455
Compare To:	20 W HID	39 W HID
CRI:	85	85
Dimming:	100% – 10%	No
Rated Life:	50,000 hours	50,000 hours



61
Lm/W

- Energy Star® Rated
- Alternate beam angles may be ordered separately
- Dimmable with electronic low voltage dimmer
- 50,000 hour rated life
- Accepts one lens/accessory

System	Model	Watt	Beam	Color Temp	Finish
WTK 120V	LED17	17W	S 20°	27 2700K	BK Black
WHK 277V	LED27	27W	F 45°	30 3000K	PT Platinum
				35 3500K	WT White
				40 4500K	

Example: **WHK-LED27F-35-WT**

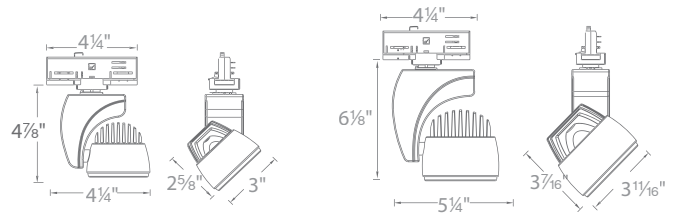

Lenses and Accessories (order separately)

LENS-20	LED17	AMB	Amber	LENS-20	LED17	FR	Frosted Lens
LENS-25	LED27	BLU	Blue	LENS-25	LED27	SPR	Spread Lens
		GRN	Green			BEL	Beam Elongated
		RED	Red				
		YEL	Yellow				

Example: **LENS-20-AMB**

Example: **LENS-25-BEL**

LEDme® Exterminator I W Track **NEW**

Power:	23 W
Lumens:	Up to 1453
CBCP:	Up to 6772
CRI:	85
Dimming:	100% – 10%
Rated Life:	50,000 hours
Compare To:	75W MR16



63
Lm/W

- Twist lock aiming mechanism
- 355° horizontal rotation and 180° vertical aiming
- Accepts one lens/accessory

Track Type	System	Model	Beam	Color Temp	Finish
W Track	WTK 120V	LED20	S 20°	27 2700K	BK Black
	WHK 277V		F 40°	30 3000K	PT Platinum
				35 3500K	WT White
				40 4000K	

Example: **WTK-LED20S-30-WT**

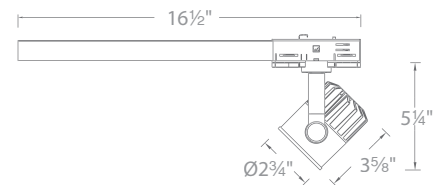

Lenses and Accessories (order separately)

<i>Color Lens</i>	LENS-16	AMB	Amber	<i>Frosted Lens</i>	LENS-16-FR	20°	RF-S	<i>Replaceable LED Modules</i>	2700K	BXRC-27E1000-B-03
<i>Dichroic Lens</i>	LENS-16-DIC	BLU	Blue						3000K	BXRC-30E1000-B-03
		GRN	Green						3500K	BXRC-35E1000-B-03
		RED	Red						4000K	BXRC-40E1000-B-03
		YEL	Yellow							
		LENS-16-FR	Frosted Lens							
		LENS-16-SPR	Spread Lens							
		LENS-16-BEL	Beam Elongating							

H / L / J Track Systems

Description: Single circuit, H, L and J/J2 Track
Power per Circuit: 1920 W max
Operating Current: Rated 20A max

H Track

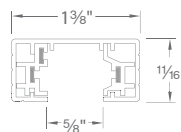

L Track

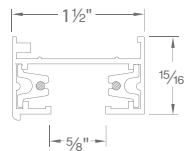

J Track

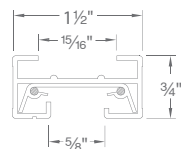

Track Sections

Model	Length	Finish	Description
HT H Track	2 2'	BK Black	120V 3-wire track
	4 4'	BN Brushed Nickel	
	6 6'	WT White	
	8 8'	DB Dark Bronze	
LT L Track	2 2'	BK Black	120V 2-wire, wide style track
	4 4'	BN Brushed Nickel	
	6 6'	WT White	
JT J/J2 Track	2 2'	BK Black	120V 2-wire, wide style track
	4 4'	BN Brushed Nickel	
	6 6'	WT White	

Example: **HT6-DB**

Each section includes two matching end caps.

Quick Connect Adapter

















Model	Finish	Dimensions	Description
EN-HQ50AR H Track EN-LQ50AR L Track EN-JQ50AR J/J2 Track	BK Black BN Brushed Nickel WT White DB* Dark Bronze	4 1/4 x 1 7/16 x 1 3/8	Use to easily connect any Quick Connect pendant or fixture. Min.Load: 1W Max Load: 50W

Track Suspension

Model	Length	Finish	Description
SK	18 18" 36 36"	BK Black BN Brushed Nickel WT White DB* Dark Bronze	Extends track from ceiling. Includes track bracket, rod and ceiling canopy.
	24 24" 48 48"	BK Black BN Brushed Nickel WT White DB* Dark Bronze	
R	18 18" 48 48"	BK Black BN Brushed Nickel WT White DB* Dark Bronze	Use with Rod Coupler (RI) to further extend track from ceiling.
	24 24" 72 72"	BK Black BN Brushed Nickel WT White DB* Dark Bronze	
	36 36" 96 96"	BK Black BN Brushed Nickel WT White DB* Dark Bronze	
SK14		BK Black BN Brushed Nickel WT White DB* Dark Bronze	Use with suspension kits to accommodate sloped ceilings. Max capacity: 7A, 800W, 120V
RI		BK Black BN Brushed Nickel WT White DB* Dark Bronze	Join two rods for suspensions longer than 48".
SK05		BK Black BN Brushed Nickel WT White DB* Dark Bronze	Used when suspension rod is field cut to custom lengths.
X	6 6" 24 24"	BK Black BN Brushed Nickel WT White DB* Dark Bronze	Extends low voltage track heads from track. Specify extension, fixture and finish. Only available as complete unit. Example: X18-HHT-809-WT
	12 12" 36 36"	BK Black BN Brushed Nickel WT White DB* Dark Bronze	
	18 18" 48 48"	BK Black BN Brushed Nickel WT White DB* Dark Bronze	
H	18 18" 36 36"	BK Black BN Brushed Nickel WT White DB* Dark Bronze	Extends H System line voltage track heads.
	24 24" 48 48"	BK Black BN Brushed Nickel WT White DB* Dark Bronze	
TBKT	18"	BK Black BN Brushed Nickel WT White DB* Dark Bronze	Extends track 24" from wall. Use two per 4' length, three per 8' length.

Example: **SK24-BK**

***DB** finish only available for H Track.

Accessories	Model	Finish	Description	
 <p>Live End Connector</p>	HLE LLE JLE	BK Black BN Brushed Nickel WT White DB* Dark Bronze	4¼" × 1⅜" × ¾" 4¼" × 1⅜" × ¾" 4¾" × 1¼" × ¾"	Use for direct wiring through ceiling. Required a canopy plate when using with a standard junction box.
 <p>Live End BX Connector</p>	HBXLE LBXLE JBXLE	BK Black BN Brushed Nickel WT White DB* Dark Bronze	6" × 1⅜" × 1 ¼" 5¾" × 1⅜" × 1 ¼" 6¼" × 1⅜" × 1 ¼"	Use with surface mounted BX or non-metallic sheathed cable. Also provides through the ceiling connection.
 <p>"I" Power Connector</p>	HI-PWR LI-PWR JI-PWR	BK Black BN Brushed Nickel WT White DB* Dark Bronze	6¾" × 1⅜" × ¾" 7" × 1⅜" × ¾" 7½" × 1⅜" × ¾"	Power entry point at the connection of 2 tracks.
 <p>"L" Connector Left</p>	HL-LEFT LL-LEFT JL-LEFT	BK Black BN Brushed Nickel WT White DB Dark Bronze*	2¾" × 2¾" × ¾" 4¼" × 4¼" × ¾" 4¼" × 4¼" × ¾"	Use to join 2 track sections to make power feedable 90° left polarity turns.
 <p>"L" Connector Right</p>	HL-RIGHT LL-RIGHT JL-RIGHT	BK Black BN Brushed Nickel WT White DB Dark Bronze*	2¾" × 2¾" × ¾" 4¼" × 4¼" × ¾" 4¼" × 4¼" × ¾"	Use to join 2 track sections to make power feedable 90° right polarity turns.
 <p>"T" Connector</p>	HT LT JT	BK Black BN Brushed Nickel WT White DB* Dark Bronze	4" × 2¾" × ¾" 7¼" × 4¼" × ¾" 7½" × 4¼" × ¾"	Use to join 3 track sections. Power feedable on H and J only. "T" Connector with opposite polarity is custom ordered.
 <p>"X" Connector</p>	HX LX JX	BK Black BN Brushed Nickel WT White DB* Dark Bronze	4½" × 4½" × ¾" 7½" × 7½" × ¾" 7½" × 7½" × ¾"	Use to join 4 track sections. Power feedable on H and J only.
 <p>"I" Connector</p>	HI LI JI	BK Black BN Brushed Nickel WT White DB* Dark Bronze	3" × 1⅜" × ¾" 3½" × 1⅜" × ¾" 3" × 1⅜" × ¾"	Use to join two sections of track with electrical continuity.
 <p>"I" Dead End Connector</p>	HI-DEC LI-DEC JI-DEC	BK Black BN Brushed Nickel WT White DB* Dark Bronze	3" × 1⅜" × ¾" 3½" × 1⅜" × ¾" 3" × 1⅜" × ¾"	Joins two sections of track without electrical continuity.
 <p>Flexible Track Connector</p>	HFLX LFLX JFLX	BK Black BN Brushed Nickel WT White DB* Dark Bronze	11" × 1⅜" × ¾" 9¾" × 1⅜" × ¾" 8½" × 1⅜" × ¾"	Connects two track sections at variable angles. Use as a transition from wall-to-wall, wall-to-ceiling, or ceiling-to-ceiling. Power feedable.
 <p>Suspension Loop</p>	H-LOOP L-LOOP J-LOOP	BK Black BN Brushed Nickel WT White DB* Dark Bronze	1⅜" × 1⅜" × 3" 1⅜" × 1⅜" × 3" 1⅜" × 1⅜" × 3"	3 inch electrical loop accepts chain hung fixtures up to 35lbs. Contains compartment for electrical connections.
 <p>15' Cord, Male Plug</p>	HCORD use with H and J	BK Black WT White	15'	Maximum capacity: 7A, 800W, 120V.
 <p>15' Cord, Male Plug w/Switch</p>	LCORDSET USE WITH L AND J			
 <p>T-Bar Drop Ceiling Attachment</p>	T-BARCLIP		1½" × 1¼"	Attaches track to T-bar drop ceilings. Use two for 2 foot or 4 foot tracks, three for 6 foot or 8 foot tracks.
 <p>Monopoint Canopy Adapter</p>	HMP LMP JMP	BK Black BN Brushed Nickel WT White DB* Dark Bronze	Ø 4⅜" Ø 4¾" 5⅜" × 5⅜"	Mount a single H, L or J system track fixture to a junction box. When used with a low voltage track head the transformer box will protrude off of the face of the monopoint.
 <p>Canopy Plate</p>	CP	BK Black BN Brushed Nickel WT White DB* Dark Bronze	4½" × 4½"	Covers a standard 4 inch junction box. Use with any powerable connectors.
 <p>Floating Canopy Connector</p>	HFC LFC JFC	BK Black BN Brushed Nickel WT White DB* Dark Bronze	4½" × 4½" × 1½" 4¼" × 4¼" × 1⅜" 4⅝" × 4⅝" × 1⅜"	Connects to octagon box. Allow track to be powered anywhere along the length of the track

*DB finish only available for H Track.

J2 Track

Description: Two circuit track with independently controllable circuits
Power per Circuit: 1920 W max
Operating Current: Each circuit is rated 20A (2 x 20A = 40A max)

Track Sections

Model	Length	Finish	Description
J2 J2 Track	T4 4'	BK Black WT White	120V 3-wire, wide style track
	T8 8'		
	T12 12'		

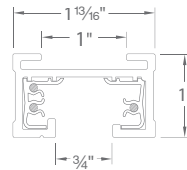

Example: **J2-T4-WT**

Each section includes two matching end caps.

J Clip

Description

	Locks connectors into 2-circuit mode	Each 4' section includes 3 Each 8' section includes 6 Each 12' section includes 9
---	--------------------------------------	---

To order additional J Clips, see accessories on next page.

Quick Connect Adapter

Model	Finish	Description
EN-JQ50AR J/J2 Track	BK Black WT White	Use to easily connect any Quick Connect pendant or fixture.

Example: **EN-JQ50AR-BK**















TRACK | FUNCTIONAL

Track Suspension

		Model	Length	Finish	Description
All Track Suspension Kit		SK	18 18" 36 36" 24 24" 48 48"	BK Black WT White	Extends track from ceiling. Includes track bracket, rod and ceiling canopy.
Suspension Kit Extender		R	18 18" 48 48" 24 24" 72 72" 36 36" 96 96"	BK Black WT White	Use with Rod Coupler (RI) to further extend track from ceiling.
Sloped Ceiling Adapter		SK14	n/a	BK Black WT White	Use with suspension kits to accommodate sloped ceilings.
Rod Coupler		RI	n/a	BK Black WT White	Join two rods for suspensions longer than 48".
Suspension Adjustment Collar		SK05	n/a	BK Black WT White	Used when suspension rod is field cut to custom lengths.
Low Voltage Track Head Extension		X	6 6" 24 24" 12 12" 36 36" 18 18" 48 48"	BK Black WT White	Extends low voltage track heads from track. Specify extension, fixture and finish. Only available as complete unit. Example: X18-HHT-809-WT
Line Voltage Track Head Extension (H track only)		H	18 18" 36 36" 24 24" 48 48"	BK Black WT White	Extends H System line voltage track heads.
Wall Mount Suspension Bracket		TBKT	18"	BK Black WT White	Extends track 24" from wall. Use two per 4' length, three per 8' length.
Wire Way Cover		J2-WCOV	n/a	BK Black WT White	Wire way cover for suspended track. Conceals electrical feed wires from stem to track live end.

Example: **SK24-BK**

Accessories		Model	Finish	Description
Live End Connector		J2-LE	BK WT Black White	Use for direct wiring through ceiling.
Live End BX Connector		J2-BXLE	BK WT Black White	Use with surface mounted BX or non-metallic sheathed cable. Also provides through the ceiling connection.
"I" Power Connector		J2-IPWR	BK WT Black White	Power entry point at the connection of 2 tracks.
"L" Connector Left		J2-LLEFT	BK WT Black White	Use to join 2 track sections to make power feedable 90° left polarity turns.
"L" Connector Right		J2-LRIGHT		Use to join 2 track sections to make power feedable 90° right polarity turns.
"T" Connector		J2-T	BK WT Black White	Use to join 3 track sections. Power feedable on H and J only. "T" Connector with opposite polarity is custom ordered.
"X" Connector		J2-X	BK WT Black White	Use to join 4 track sections. Power feedable on H and J only.
"I" Connector		J2-I	BK WT Black White	Use to join two sections of track with electrical continuity.
"I" Dead End Connector		J2-IDEC	BK WT Black White	Joins two sections of track without electrical continuity.
Flexible Track Connector		J2-FLX	BK WT Black White	Connects two track sections at variable angles. Use as a transition from wall-to-wall, wall-to-ceiling, or ceiling-to-ceiling. Power feedable.
2-Circuit Track Conversion Clip		JCLIP	BK WT Black White	Locks connectors into 2-circuit mode. Order one for each luminaire on second circuit. J2-T4 includes 3 JCLIP adapters, J2-T8 includes 6 JCLIP adapters, J2-T12 includes 9 JCLIP adapters.
T-Bar Drop Ceiling Attachment		T-BARCLIP	n/a	Attaches track to T-bar drop ceilings. Use two for 2 foot or 4 foot tracks, three for 6 foot or 8 foot tracks.
Octagon Box Cover		J2-UCP	BK WT Black White	Junction box cover, used with J2-IPWR, J2-LE, J2-LRIGHT, J2-LLEFT, J2-T and J2-X for junction box feed.
T-Bar End Feed		J2-TBLE	BK WT Black White	Feeds track from above when T-Bar is directly above track.

Example: **J2-FLX-BK**

LEDme® LOGOS | H / L / J Track

	LED23	LED40
Power:	23 W	40 W
Lumens:	Up to 1830	Up to 3000
CBCP:	Up to 18,049	Up to 24,767
Compare To:	39 W HID	70 W HID
CRI:	85	85
Dimming:	100% – 10%	100% – 10%
Rated Life:	50,000 hours	50,000 hours



79
Lm/W

- Energy Star® Rated
- Direct replacement for 39W metal halide fixtures
- Single circuit or two circuit track options
- Lockable "hot" aiming mechanism
- Single tool-free lens assembly for easy in field change out of beam angle
- Alternate beam angles may be ordered separately

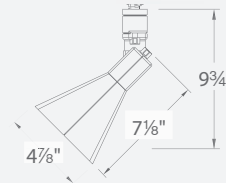
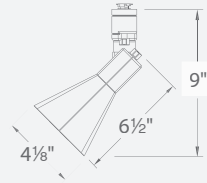

Track Type	System	Model	Beam	Color Temp	Finish	
H, L, J/J2 Track	L H J	120V	LED23 23W LED40 40W	S* 12°	27 2700K 30 3000K 35 3500K 40 4000K	BK Black WT White
				N 24°		
				F 36°		
				E 19° x 32° elliptical spread		

Example: **L-LED23S-40-WT**

*not Energy Star Rated

Interchangeable Lens Reflectors

	LED23	LED40
12°	OPH-9X3-12D	OPH-16X3-12D
24°	OPH-9X3-25D	OPH-16X3-25D
36°	OPH-9X3-40D	OPH-16X3-40D
19° x 32°	OPH-9X3-ELD	OPH-16X3-ELD

Replaceable LED Modules

2700K	RM-9X3-27	RM-16X3-27
3000K	RM-9X3-30	RM-16X3-30
3500K	RM-9X3-35	RM-16X3-35
4000K	RM-9X3-40	RM-16X3-40

TRACK | FUNCTIONAL

LEDme® ARGOS | H / L / J Track

Power:	25 W
Lumens:	Up to 1525
CBCP:	Up to 5868
Compare To:	39 W HID
CRI:	85
Dimming:	100% – 10%
Rated Life:	50,000 hours



61
Lm/W

- Energy Star® Rated
- Single circuit or two circuit track options
- Single tool-free lens assembly for easy in field change out of beam angle
- Alternate beam angles may be ordered separately

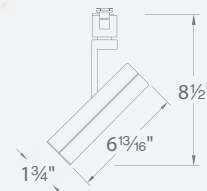

Track Type	System	Model	Beam	Color Temp	Finish	
H, L, J/J2 Track	L H J	120V	LED25	S 20°	27 2700K 30 3000K 35 3500K 40 4000K	BK Black WT White
				F 42°		

Example: **L-LED25S-27-BK**

Interchangeable Lens

20°	OPH-10X3-20D
42°	OPH-10X3-42D

Replaceable LED Modules

2700K	RM-10X3-27
3000K	RM-10X3-30
3500K	RM-10X3-35
4000K	RM-10X3-40

LEDme® Impulse | H / L / J Track

	LED810	LED820
Power:	12 W	21 W
Lumens:	Up to 575	Up to 1030
CBCP:	Up to 2263	Up to 2521
Compare To:	50 W MR16	75 W MR16
CRI:	85	85
Dimming:	100% – 10%	100% – 10%
Lens Options:	1 replacement lens	1 replacement lens
Rated Life:	50,000 hours	50,000 hours

- Perfect for retail or museum applications where the use of a barn door or framing projector is needed for beam control
- Free of UV and IR radiation, for color sensitive clothing or artwork
- Alternate beam angles may be ordered separately



48
Lm/W

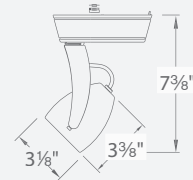

System	Model	Beam	Color Temp	Finish
L L Track	LED810	S 20°	WW 3000K	BK Black
H H Track		F 32°	CW 4000K	DB Dark Bronze
J J/J2 Track				WT White



Example: **L-LED810S-WW-WT**

Interchangeable Lens

20°	SL-REF-20
32°	SL-REF-32

Replaceable LED Modules

3000K	RM1X10-30-TK
4000K	RM1X10-40-TK

Accessories (order separately)

Model	Finish
008FP Framing Projector	BK Black
	DB Dark Bronze
	WT White
801BD Barn Door	BK Black
	WT White

works with both LED810 and LED820

System	Model	Beam	Color Temp	Finish
L L Track	LED820	S 28°	27 2700K	BK Black
H H Track		F 45°	WW 3000K	DB Dark Bronze
J J/J2 Track			35 3500K	WT White
			CW 4000K	

Example: **L-LED820S-27-DB**



49
Lm/W

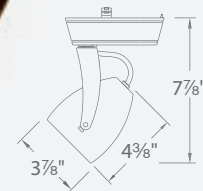

Interchangeable Reflectors

28°	SL-REF-LUX10-25
45°	SL-REF-LUX10-40

Replaceable LED Modules

2700K	LXS8-PW27
3000K	LXS8-PW30
3500K	LXS8-PW35
4000K	LXS8-PW40

LEDme® Wall Washer | H / L / J Track NEW

Power: 42 W
Lumens: Up to 2470
CRI: 85
Dimming: 100% – 10%
Rated Life: 50,000 hours

60
Lm/W



- Replaces halogen and fluorescent wall wash luminaires
- Die-cast aluminum construction
- Simple and professional design
- Thin side profile
- 45° vertical tilt

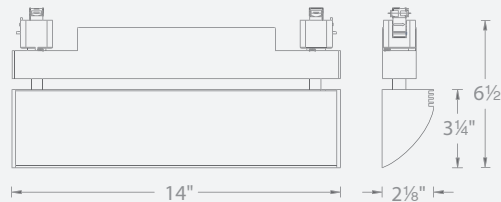

System	Model	Color Temp	Finish
H H Track	LED42W	27 2700K	BK Black WT White
L L Track		30 3000K	
J J/J2 Track		35 3500K	
		40 4000K	

Example: **H-LED42W-30-WT**

TRACK | FUNCTIONAL

LEDme® Wash Light | H / L / J Track NEW BRIGHTER

	LED110	LED210
Power:	14W	27 W
Lumens:	Up to 935	Up to 1990
CRI:	85	85
Dimming:	100% – 1%	100% – 1%
Rated Life:	50,000 hours	50,000 hours

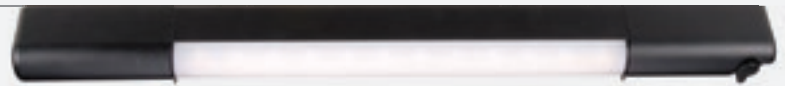

- Perfect solution for lighting stacks, shelves or signage
- Low profile, extends only 2" from track
- Adjustable beam angle

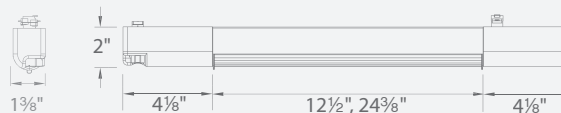

61
Lm/W

System	Model	Length	Color Temp	Finish
H H Track	LED110W	20 3/4"	WW 3000K	BK Black WT White
L L Track		LED210W	32 5/8"	
J J/J2 Track				

Example: **L-LED110W-WW-BK**

Replaceable LED Modules

	LED110	LED210
3000K	RM36X02-30RE1-24-1	RM36X02-30RE1-24-1 RM36X02-30RE1-24-2
4000K	RM36X02-40RE1-24-1	RM36X02-40RE1-24-1 RM36X02-40RE1-24-2

For LED210 order both modules listed.

LEDme® Reflex | H / L / J Track NEW

	LED17	LED27
Power:	17 W	27 W
Lumens:	Up to 1125	Up to 1900
CBCP:	Up to 3550	Up to 7300
Compare To:	20 W HID	39 W HID
CRI:	85	85
Dimming:	100% – 10%	No
Rated Life:	50,000 hours	50,000 hours



61
Lm/W

- Energy Star® Rated
- Alternate beam angles may be ordered separately
- Dimmable with electronic low voltage dimmer
- 50,000 hour rated life
- Accepts one lens/accessory

System	Model	Watt	Beam	Color Temp	Finish
H H Track	LED17	17W	S 20°	27 2700K	BK Black
L L Track				30 3000K	
J J/J2 Track				35 3500K	
	LED27	27W	F 45°	40 4500K	BN Brushed Nickel
					WT White

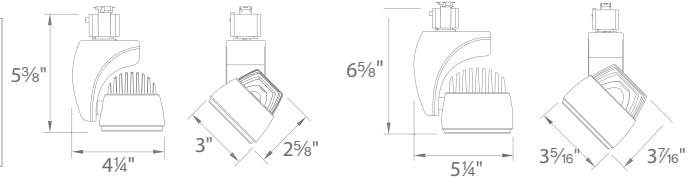

Example: **H-LED27F-27-BN**

Lenses and Accessories (order separately)

<i>LENS-20</i>	<i>LED17</i>	<i>AMB</i>	<i>Amber</i>	<i>LENS-20</i>	<i>LED17</i>	<i>FR</i>	<i>Frosted Lens</i>	
	<i>LENS-25</i>	<i>LED27</i>	<i>BLU</i>					<i>Blue</i>
		<i>GRN</i>	<i>Green</i>					
		<i>RED</i>	<i>Red</i>					
		<i>YEL</i>	<i>Yellow</i>					
		<i>SPR</i>	<i>Spread Lens</i>					
		<i>BEL</i>	<i>Beam Elongated</i>					

Example: **LENS-20-AMB**

Example: **LENS-25-BEL**

LEDme® Exterminator | H / L / J Track

Power:	23 W
Lumens:	Up to 1453
CBCP:	Up to 6772
CRI:	85
Dimming:	100% – 10%
Rated Life:	50,000 hours
Compare To:	75W MR16



63
Lm/W

- Twist lock aiming mechanism
- 355° horizontal rotation and 180° vertical aiming
- Accepts one lens/accessory

Track Type	System	Model	Beam	Color Temp	Finish
H, L, J/J2 Track	L	120V	LED20	S 20°	27 2700K
				H	30 3000K
				J	35 3500K
					40 4000K
				BK Black	
				WT White	

Example: **L-LED20S-30-WT**

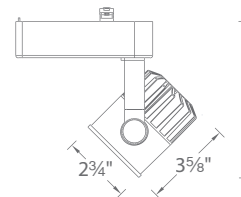

Lenses and Accessories (order separately)

<i>Color Lens</i>	<i>LENS-16</i>	<i>AMB</i>	<i>Amber</i>	<i>Frosted Lens</i>	<i>LENS-16-FR</i>
<i>Dichroic Lens</i>	<i>LENS-16-DIC</i>	<i>BLU</i>	<i>Blue</i>		
		<i>GRN</i>	<i>Green</i>		
		<i>RED</i>	<i>Red</i>		
		<i>YEL</i>	<i>Yellow</i>		
			<i>Spread Lens</i>	<i>LENS-16-SPR</i>	
			<i>Beam Elongating</i>	<i>LENS-16-BEL</i>	

Interchangeable Reflectors

20°	RF-S
40°	RF-F

Replaceable LED Modules

2700K	BXRC-27E1000-B-03
3000K	BXRC-30E1000-B-03
3500K	BXRC-35E1000-B-03
4000K	BXRC-40E1000-B-03

Low Voltage LED | H / L / J Track

Power: 8W
Lumens: 450
CBCP: 833
Compare To: 35 W MR16
Color Temp: 3000K
CRI: 85
Dimming: Yes
Rated Life: 25,000 hours

- MR16 LED included
- 1 watt to 60 watt load transformer
- Lamp comes pre-installed in fixture
- Fixtures specifically designed to ensure proper lamp fit

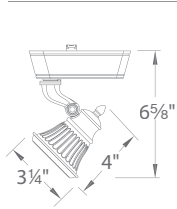

Rialto LED

System	Model	Finish
LHT L Track	886LED	AB <i>Antique Bronze</i>
HHT H Track		
JHT J/J2 Track		

Example: **LHT-886LED-AB**

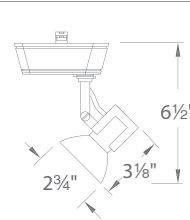

Radiant LED

System	Model	Finish
LHT L Track	856LED	AB <i>Antique Bronze</i>
HHT H Track		BK <i>Black</i>
JHT J/J2 Track		BN <i>Brushed Nickel</i>
		WT <i>White</i>

Example: **LHT-856LED-BN**

TRACK | FUNCTIONAL

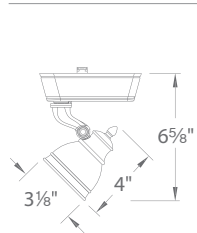

Caribe LED

System	Model	Finish
LHT L Track	874LED	AB <i>Antique Bronze</i>
HHT H Track		
JHT J/J2 Track		

Example: **LHT-874LED-AB**

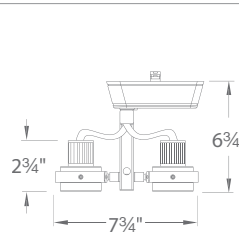

Double Droid LED

System	Model	Finish
LHT L Track	817LED	BK <i>Black</i>
HHT H Track		PT/BK <i>Platinum/Black</i>
JHT J/J2 Track		PT/WT <i>Platinum/White</i>
		WT <i>White</i>

Example: **LHT-817LED-BK**

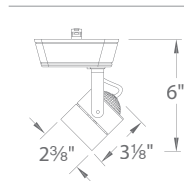

809 LED

System	Model	Finish
LHT L Track	809LED	BK <i>Black</i>
HHT H Track		BN <i>Brushed Nickel</i>
JHT J/J2 Track		WT <i>White</i>

Example: **LHT-809LED-BN**

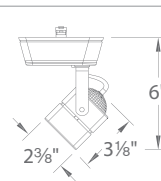

802 LED

System	Model	Finish
LHT L Track	802LED	BK <i>Black</i>
HHT H Track		BN <i>Brushed Nickel</i>
JHT J/J2 Track		WT <i>White</i>

Example: **LHT-802LED-BK**

Low Voltage LED | H / L / J Track

Power: 8W
Lumens: 450
CBCP: 833
Compare To: 35 W MR16
Color Temp: 3000K
CRI: 85
Dimming: Yes
Rated Life: 25,000 hours

- MR16 LED included
- 1 watt to 60 watt load transformer
- Lamp comes pre-installed in fixture
- Fixtures specifically designed to ensure proper lamp fit

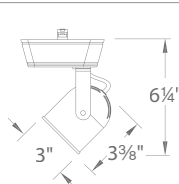
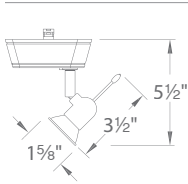

816 LED

System	Model	Finish
LHT L Track	816LED	BK Black
HHT H Track		BN Brushed Nickel
JHT J/J2 Track		WT White

Example: **LHT-816LED-BK**

808 LED

System	Model	Finish
LHT L Track	808LED	BK Black
HHT H Track		DB Dark Bronze
JHT J/J2 Track		WT White

Example: **LHT-808LED-DB**

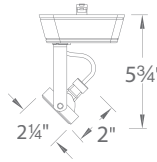
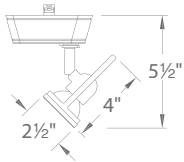

Dune LED

System	Model	Finish
LHT L Track	826LED	BK Black
HHT H Track		BN Brushed Nickel
JHT J/J2 Track		WT White

Example: **LHT-826LED-BN**

180 LED

System	Model	Finish
LHT L Track	180LED	BK Black
HHT H Track		BN Brushed Nickel
JHT J/J2 Track		WT White

Example: **LHT-180LED-BN**

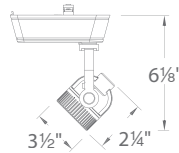
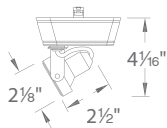

160 LED

System	Model	Finish
LHT L Track	160LED	BK Black
HHT H Track		WT White
JHT J/J2 Track		

Example: **LHT-160LED-WT**

Range LED

System	Model	Finish
LHT L Track	164LED	BK Black
HHT H Track		WT White
JHT J/J2 Track		

Example: **LHT-164LED-WT**

Low Voltage LED | H / L / J Track

Power: 8W
Lumens: 450
CBCP: 833
Compare To: 35 W MR16
Color Temp: 3000K
CRI: 85
Dimming: Yes
Rated Life: 25,000 hours

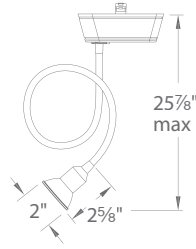

204 LED

System	Model	Finish
LHT L Track	204LED	BK Black
HHT H Track		BN Brushed Nickel
JHT J/J2 Track		WT White

Example: **LHT-204LED-WT**

- MR16 LED included
- 1 watt to 60 watt load transformer
- Lamp comes pre-installed in fixture
- Fixtures specifically designed to ensure proper lamp fit

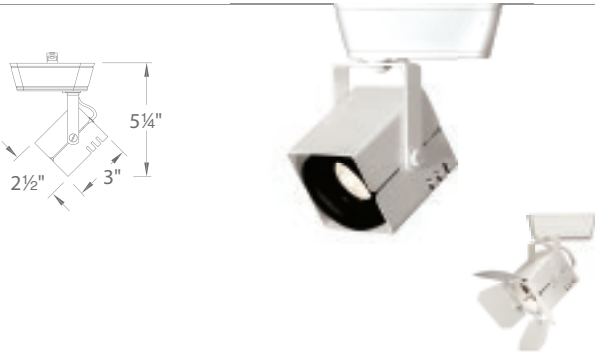

801 LED

System	Model	Finish
LHT L Track	801LED	BK Black
HHT H Track		WT White
JHT J/J2 Track		

Example: **LHT-801LED-WT**

Barn Door Accessory

Model	Finish
801BD	BK Black
	WT White

order separately



007 LED

System	Model	Finish
LHT L Track	007LED	BK Black
HHT H Track		BN Brushed Nickel
JHT J/J2 Track		WT White

Example: **LHT-007LED-WT**

Framing Projector

Model	Finish
008FP	BK Black
	WT White

order separately

TRACK | FUNCTIONAL

Line Voltage LED | H / L / J Track

Power: 8W
Lumens: 470
CBCP: 877
Compare To: 50 W MR16
Color Temp: 3000K
CRI: 85
Rated Life: 25,000 hours

- GU10 LED included
- Lamp comes pre-installed in fixture
- Fixtures specifically designed to ensure proper lamp fit

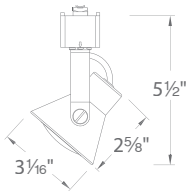

103 LED

System	Model	Finish
LTK L Track	103LED	BK Black
HTK H Track		DB Dark Bronze
JTK J/J2 Track		WT White

Example: **LTK-103LED-BK**

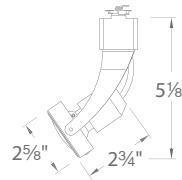

104 LED

System	Model	Finish
LTK L Track	104LED	BK Black
HTK H Track		DB Dark Bronze
JTK J/J2 Track		WT White

Example: **LTK-104LED-WT**

LEDme® Reflex I Monopoint **NEW**

LED Display Spot Light

- Power:** 17W
Lumens: Up to 1125
CBCP: Up to 3780
Compare To: 75W MR16
CRI: 85
Dimming: 100% – 10%
Rated Life: 50,000 hours
- Energy Star® rated
 - Die-cast aluminum construction
 - Free of projected heat and UV and IR radiation
 - Can be wall or ceiling mounted
 - ANSI Compliant Warm/Neutral LED Bins, for the finest color consistency possible
 - 360° horizontal rotation and 180° vertical aiming
 - ETL & cETL listed



68
Lm/W

Model	Beam	Color Temp	Finish
MO-LED17	S 20°	27 2700K	BK Black WT White
		30 3000K	
	F 45°	35 3500K	
		40 4000K	

Example: **MO-LED17S-27-WT**

Replacement Modules		Interchangeable Lens Reflectors	
2700K	RM-11X3-27	20°	OPH-11X3-20D
3000K	RM-11X3-30	45°	OPH-11X3-45D
3500K	RM-11X3-35		
4000K	RM-11X3-40		

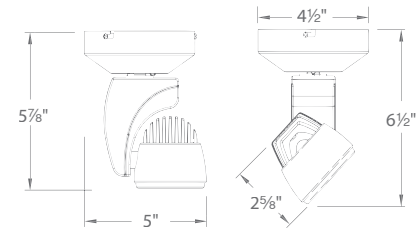

LEDme® ARGOS I Monopoint **NEW**

LED Display Spot Light

- Power:** 25W
Lumens: Up to 1525
CBCP: Up to 5868
Compare To: 39W HID
CRI: 85
Dimming: 100% – 10%
Rated Life: 50,000 hours
- Energy Star® rated
 - Can be wall or ceiling mounted
 - Free of projected heat and UV and IR radiation
 - Tool-free lens assembly for easy change of beam angle
 - ETL & cETL listed



61
Lm/W

Model	Beam	Color Temp	Finish
MO-LED25	S 20°	27 2700K	BK Black WT White
		30 3000K	
	F 42°	35 3500K	
		40 4000K	

Example: **MO-LED25S-30-BK**

Replacement Modules		Interchangeable Lens	
2700K	RM-10X3-27	20°	OPH-10X3-20D
3000K	RM-10X3-30	42°	OPH-10X3-42D
3500K	RM-10X3-35		
4000K	RM-10X3-40		

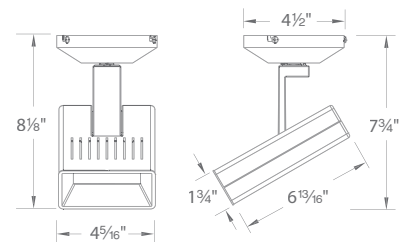

CEILING | FUNCTIONAL

Flexrail1™ Power Feeds and Transformers

Rail Sections

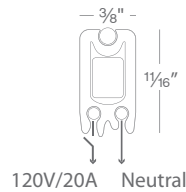









Model #		Finish	
HM1	T4 4'	PT	Platinum
	T8 8'	DB	Dark Bronze

Example: **HM1-T4-PT**
Includes two matching end caps.

Quick Connect Adapter	Model	Finish	Description
	HM1-EN50	PT Platinum DB Dark Bronze	Order one per Quick Connect™ fixture or pendant used.

Power Feeds	Model #	Finish	Length	Description
Stem Power Feed 	HM1-PCT6	PT Platinum DB Dark Bronze	6"	May be placed anywhere along the length of the rail over a junction box supplying 120 volts. Also serves as a support. Cannot be extended or field cut.
	HM1-PCT12		12"	
	HM1-PCT24		24"	
	HM1-PCT36		36"	
	HM1-PCT48		48"	
Flexible Ceiling Power Feed 	HM1-PCC12	PT Platinum DB Dark Bronze	12"	Used for power on sloped ceilings, custom suspension lengths.
	HM1-PCC24		24"	
	HM1-PCC36		36"	
	HM1-PCC48		48"	
	HM1-PCC96		96"	

Rail Suspensions	Model	Finish	Dimensions	Description
Standard Ceiling Standoff 	HM1-X6	PT Platinum DB Dark Bronze	6"	Supports rail for flat ceilings and surfaces.
	HM1-X12		12"	
	HM1-X24		24"	
	HM1-X36		36"	
	HM1-X48		48"	
T-Bar Ceiling Standoff 	HM1-TB6	PT Platinum DB Dark Bronze	6"	Conceals a T-Bar clip under the canopy for standard 1" T-Bar ceilings.
	HM1-TB12		12"	
	HM1-TB24		24"	
	HM1-TB36		36"	
	HM1-TB48		48"	
Sloped Ceiling Standoff 	HM1-XS6	PT Platinum DB Dark Bronze	6"	Supports rail for sloped ceiling. Accommodates angles up to 45°.
	HM1-XS12		12"	
	HM1-XS24		24"	
	HM1-XS36		36"	
	HM1-XS48		48"	
Sloped Ceiling Adapter 	SK14S	PT Platinum DB Dark Bronze	1 1/16" × 2 5/16"	Use with standoffs and "I" connectors for mounting on a sloped ceiling.
"I" Connector 	HM1-I6	PT Platinum DB Dark Bronze	6"	Connects two sections of rail with electrical continuity.
	HM1-I12		12"	
	HM1-I24		24"	
	HM1-I36		36"	
	HM1-I48		48"	
"I" Dead-End Connector 	HM1-IDEC6	PT Platinum DB Dark Bronze	6"	Connects two sections of rail with no electrical continuity.
	HM1-IDEC12		12"	
	HM1-IDEC24		24"	
	HM1-IDEC36		36"	
	HM1-IDEC48		48"	
Variable Angle Connector 	HM1-VA6	PT Platinum DB Dark Bronze	6"	Connects two sections of rail with electrical continuity. Connects at any angle up to 270°.
	HM1-VA12		12"	
	HM1-VA24		24"	
	HM1-VA36		36"	
	HM1-VA48		48"	
Field Shortening Adapter 	HM-XADJ	PT Platinum DB Dark Bronze	9/16" × 13/16"	Use for custom length standoffs or "I" connector rods to replace threaded ends.
Rod Coupler 	XI	PT Platinum DB Dark Bronze	1/2" × 13/16"	Connects two standoffs or "I" connector rods together to form a longer drop.

Example: **HM1-VA6-PT**

LEDme® Wall Washer | Flexrail™ **NEW**

Power: 42 W
Lumens: Up to 2470
CRI: 85
Dimming: 100% – 10%
Rated Life: 50,000 hours

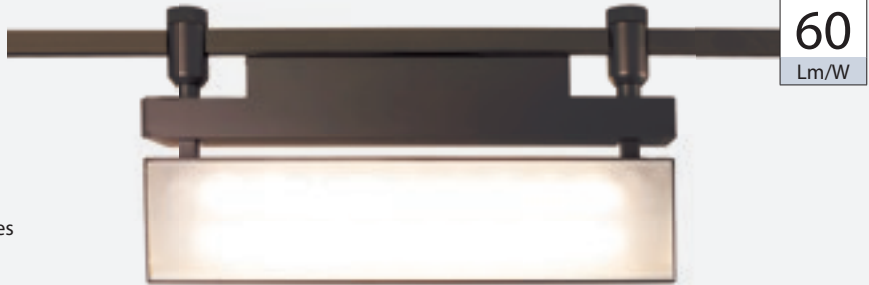

- Replaces halogen and fluorescent wall wash luminaires
- Die-cast aluminum construction
- Simple and professional design
- Thin side profile
- 45° vertical tilt

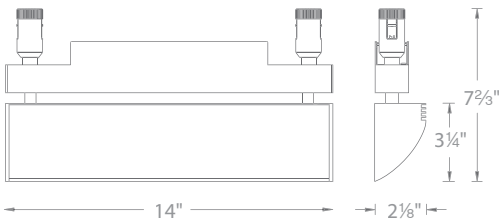

Average Footcandle Performance

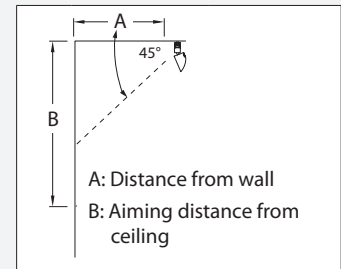

		A	
		3'	4'
B	1'	37	20
	2'	45	24
	4'	28	20
	6'	11	12

System	Model	Color Temp		Finish	
HM1	LED42W	27	2700K	DB	Dark Bronze
		30	3000K		
		35	3500K		
		40	4000K		
				PT	Platinum

Example: **HM1-LED42W-27-DB**



RAIL | FUNCTIONAL

LEDme® Reflex | Flexrail™ **NEW**

	LED17	LED27
Power:	17 W	27 W
Lumens:	Up to 1125	Up to 1900
CBCP:	Up to 3550	Up to 7300
Compare To:	20 W HID	39 W HID
CRI:	85	85
Dimming:	100% – 10%	No
Rated Life:	50,000 hours	50,000 hours



61
Lm/W

System	Model	Watt	Beam	Color Temp	Finish
HM1 Flexrail™	LED17	17W	S 10°	27 2700K	DB Dark Bronze
		27W	F 25°	30 3000K	
	LED27	27W		35 3500K	PT Platinum
				40 4500K	

Example: **HM1-LED27S-30-DB**

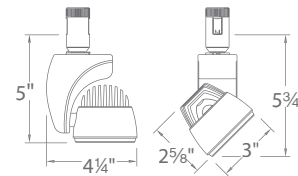

Lenses and Accessories (order separately)

Color Lens	Model	For	Color	Model	For	Finish	Finish
LENS-20		for LED17	AMB Amber	LENS-20	LED17	FR Frosted Lens	SPR Spread Lens BEL Beam Elongated
LENS-25		for LED27	BLU Blue	LENS-25	LED27		
			GRN Green				
			RED Red				
			YEL Yellow				

Example: **LENS-25-BEL**

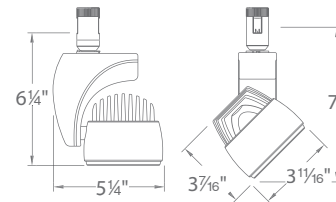

RAIL | FUNCTIONAL

LEDme® Argos | Flexrail™ **NEW**

Power:	25 W	<ul style="list-style-type: none"> • 360° horizontal and 90° vertical hot aiming • Dimming with electronic low voltage dimmer • 50,000 hour rated life • Energy Star® Rated
Lumens:	Up to 1525	
CBCP:	Up to 5868	
CRI:	85	
Dimming:	100% – 10%	
Rated Life:	50,000 hours	
Compare To:	39 W HID	



61
Lm/W

System	Model	Beam	Color Temp	Finish
HM1	LED25	S 20°	27 2700K	PT Black DB White
			30 3000K	
		F 42°	35 3500K	
			40 4000K	

Example: **HM1-LED25S-27-PT**

Interchangeable Lens Reflectors

20°	OPH-10X3-20D
42°	OPH-10X3-42D

Replaceable LED Modules

2700K	RM-10X3-27
3000K	RM-10X3-30
3500K	RM-10X3-35
4000K	RM-10X3-40

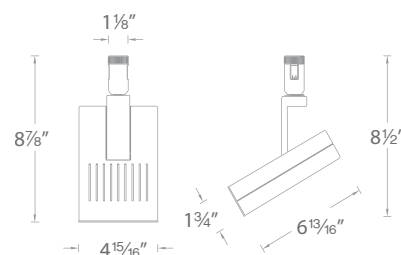

Quick Connect™ Fixtures

Lamping: 12V/24V MR16G
Power: 50 W max

Model	Extension	Finish
QF-186	X3 3"	BN Brushed Nickel
	X6 6"	CH Chrome
	X12 12"	DB Dark Bronze

Example: **QF-186X3-DB** with **G111-AM**
Order any Extension in any Finish.

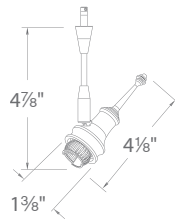

Model	Extension	Finish
QF-187	X3 3"	BN Brushed Nickel
	X6 6"	CH Chrome
	X12 12"	DB Dark Bronze

Example: **QF-187X3-BN** with **G111-WT**
Order any Extension in any Finish.

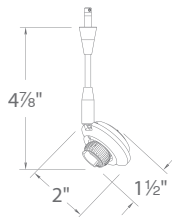

Model	Extension	Finish
QF-188	X3 3"	BN Brushed Nickel
	X6 6"	CH Chrome
	X12 12"	DB Dark Bronze

Example: **QF-188X3-CH** with **G116-CH**
Order any Extension in any Finish.

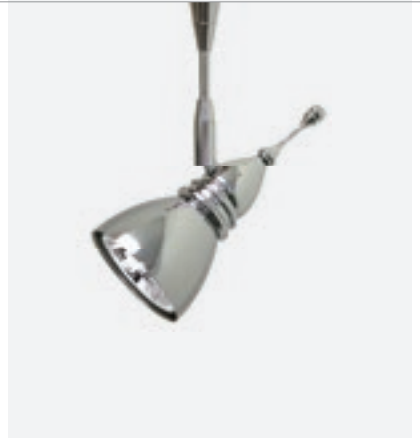
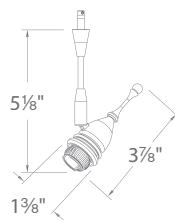

Quick Connect™ Adapters (order separately)

System	Model	Finish	System	Model	Finish
Solorail™	LM-QADP	BN, CH, DB	L Track	EN-LQ50AR	BK, BN, WT
Duorail™	LM2-QADP	BN, CH, DB	H Track	EN-HQ50AR	BK, BN, DB, WT
Flexrail1™	HM1-EN50	DB, PT	J Track	EN-JQ50AR	BK, BN, WT

Glass and Shield Options (order separately)

G111	G112	G113	G114	G115	G116
2 1/4"W x 1 3/4"H	2 1/4"W x 1 3/4"H	2 1/4"W x 1 3/4"H	2 5/8"W x 2 1/2"H	2 1/4"W x 1 3/4"H	2 1/4"W x 1 3/4"H
  	 	 	    	 	 
AM BL WT	AM WT	AM WT	AM BL GR RD WT	BN DB	BN DB

AM-Amber, **BL**-Blue, **BN**-Brushed Nickel, **DB**-Dark Bronze, **GR**-Green, **RD**-Red, **WT**-White



BEAUTY SPOTS™ | DECORATIVE

Featured Product: DR-LED302-30-CH with DR-G362-CL







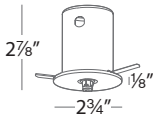



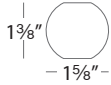
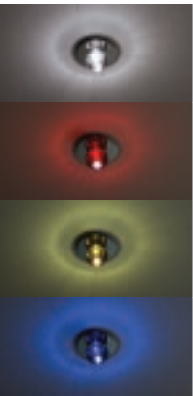

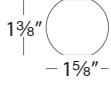

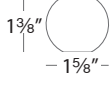

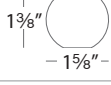
LED Beauty Spots™ **NEW**

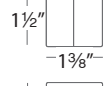
Cool operating, energy efficient LED Beauty Spots™. Polished and cut by hand from optical crystals to create sparkling patterns of light. An impressive custom crystal display arranged in a pattern or a random array.

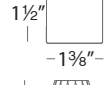
1. Order a canopy for each crystal

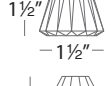
		System	Lumen	Watt	Finish	Cutout
		DR-LED302-30-CH <i>LED integrated</i>	150	4.5 W	Chrome	2 3/8"

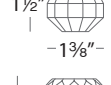
2. Choose a crystal

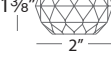
		DR-G352-CL	<i>Clear color crystal</i>	
		DR-G352-RD	<i>Red color crystal</i>	
		DR-G352-AM	<i>Amber color crystal</i>	
		DR-G352-BL	<i>Blue color crystal</i>	
		DR-G355-CL	<i>Cubix</i>	
		DR-G356-CL	<i>Irix</i>	
		DR-G361-CL	<i>Duchess</i>	
		DR-G362-CL	<i>Princess</i>	
		DR-G363-CL	<i>Empress</i>	

BEAUTY SPOTS™ | DECORATIVE

3. Select a transformer

Class 2 transformers with 24VAC output

System	Watt	Number of LED canopies it can serve	Input	Output
EN-2460-RB2	60W	12	120V	24V
EN-24100-RB2	96W	21		

Universal Sconce System **NEW**

Quick Adjust™ Pendant Sconce

Compatible with Quick Connect™ Pendants

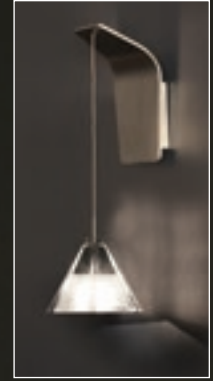

Sconce Allows for Easy Cable Adjustments up to 72"

SCONCE | QUICK CONNECT™



Shown: **WS-QA72-CH** with **QPLED939-BI/CH**

1. Select Sconce Finish

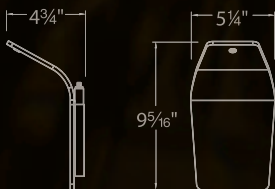

Model	Finish
WS-QA72	BN <i>Brushed Nickel</i>
	CH <i>Chrome</i>
	RB <i>Rubbed Bronze</i>

Example: **WS-QA72-CH**

2. Select Pendant/Glass

- Accommodates any pendant under 6" in diameter (order separately)
- Choose from LED or incandescent lamping
- Socket sets available in multiple styles with matching finishes to the sconce (order separately)
- All bi-pin socket sets can accept an LED bi-pin (order separately - JCLEL-2-30-WT)

LEDme® 300 Series	LED 400 Series	LEDme® 500 Series	500 Series	600 Series	700 Series	900 Series
2.75W LED	5.6W LED	2.75W LED	50W Halogen Bi-Pin	50W Halogen Bi-Pin	50W Xenon Bi-Pin	50W Halogen Bi-Pin



Shown: **WS-MR57LED-CH**
with **G542-BI**

Accommodates any 500 series glass
under 6" in diameter (order separately)

Integrated LED **NEW**

Lamping: *LED*
Power: *6W*
Lumens: *305*
Color Temp: *3000K*
CRI: *85*
Dimming: *100% – 10%*
Rated Life: *50,000 hours*

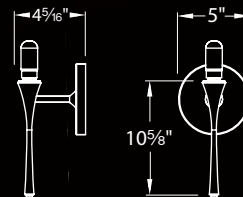

Model	Finish	
WS-MR57LED	BN	<i>Brushed Nickel</i>
	CH	<i>Chrome</i>
	RB	<i>Rubbed Bronze</i>

Example: **WS-MR57LED-BN** with **G542-BI**

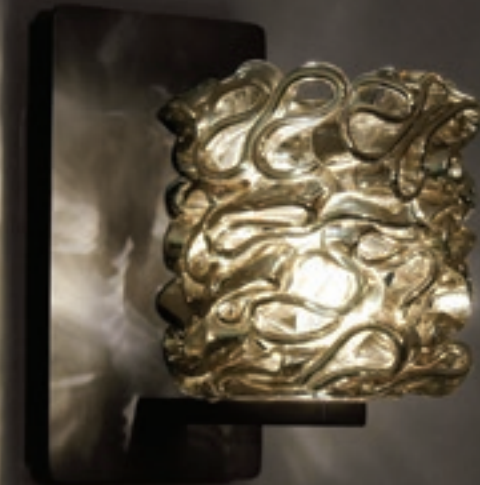

Shown: **WS-MR58-RB** with **G544-GL**

Accommodates any 500 series glass
under 6" in diameter (order separately)

Modular LED **NEW**

	LED	Halogen
Lamping:	<i>Integral LED</i>	<i>12V G6.35 bi-pin</i>
Power:	<i>6W</i>	<i>50W max</i>
Lumens:	<i>305</i>	
Color Temp:	<i>3000K</i>	
CRI:	<i>85</i>	

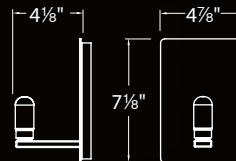

Model	Lamping	Finish	
WS-MR58LED	<i>LED</i>	BN	<i>Brushed Nickel</i>
WS-MR58	<i>Bi-pin</i>	CH	<i>Chrome</i>
		RB	<i>Rubbed Bronze</i>

Example: **WS-MR58LED-RB** with **G544-GL**

Haven | Eternity Jewelry Collection **NEW**

Lamping: LEDme® 12V Halogen JC-50
 Power: 4W 50W max
 Lumens: 330
 Color Temp: 3000K
 CRI: 85

PENDANT | QUICK CONNECT™



Shown: QP-LED539-BI/CH



Shown: QP-LED539-CD/DB



Shown: QP-LED539-WD/CH

System	Model	Lamping	Shade Finish	Socket Finish
MP	Canopy	LED539	BI Black Ice	BN Brushed Nickel
QP	Quick Connect™	539	CD Champagne Diamond WD White Diamond (Clear)	CH Chrome DB Dark Bronze

Example: QP-LED539-CD/DB

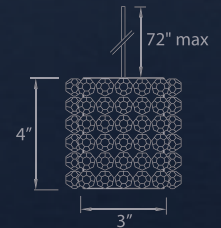

Canopy models include Quick Adjust™ canopy
 Quick Connect™ models require additional adapter



Quick Adjust™ Canopy



PENDANT | QUICK CONNECT™

Haven | Eternity Jewelry Collection **NEW**

Lamping: LED 12V Xenon BP-50
Power: 6.4W 50 W Max
Lumens: 450
Color Temp: 3000K
CRI: 85

PENDANT | QUICK CONNECT™



Shown: QP-LED939-WD/CH



Shown: QP-LED939-CD/DB



Shown: QP-LED939-BI/BN

System	Model	Lamping	Shade Finish	Socket Finish
MP Canopy	LED939 939	LED Xenon	BI Black Ice	BN Brushed Nickel
QP Quick Connect™			CD Champagne Diamond	CH Chrome
			WD White Diamond (Clear)	DB Dark Bronze

Example: **QP-LED939-BI/DB**

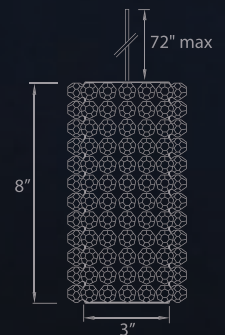

Quick Adjust™ Canopy

Canopy models include Quick Adjust™ canopy
 Quick Connect™ models require additional adapter

Giselle | Eternity Jewelry Collection **NEW**

Lamping: LEDme® 12V Halogen JC-50
 Power: 4W 50W max
 Lumens: 330
 Color Temp: 3000K
 CRI: 85



Shown: QP-LED543-BI/BN



Shown: QP-LED543-WD/CH



Shown: QP-LED543-CD/DB

PENDANT | QUICK CONNECT™

System	Model	Lamping	Shade Finish	Socket Finish
MP Canopy	LED543 543	LED Halogen	BI Black Ice CD Champagne Diamond WD White Diamond (Clear)	BN Brushed Nickel
QP Quick Connect™				CH Chrome DB Dark Bronze

Example: **MP-LED543-WD/BN**

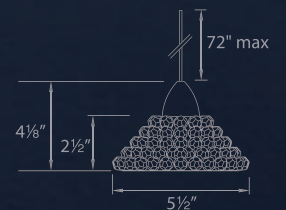

Quick Adjust™ Canopy

Canopy models include Quick Adjust™ canopy
 Quick Connect™ models require additional adapter

Gia | Eternity Jewelry Collection **NEW**

Lamping: LEDme® 12V Halogen JC-50
 Power: 4W 50W max
 Lumens: 330
 Color Temp: 3000K
 CRI: 85

PENDANT | QUICK CONNECT™



Shown: QP-LED542-WD/CH

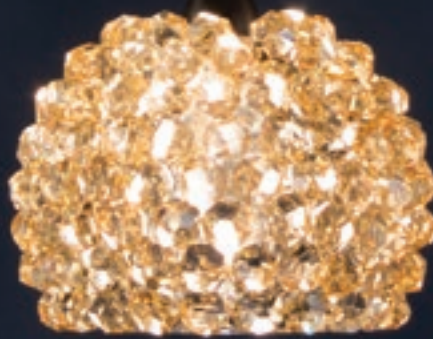

Shown: QP-LED542-CD/DB



Shown: QP-LED542-BI/CH

System	Model	Lamping	Shade Finish	Socket Finish
MP Canopy	LED542 542	LED Halogen	BI Black Ice	BN Brushed Nickel
QP Quick Connect™			CD Champagne Diamond	CH Chrome
			WD White Diamond (Clear)	DB Dark Bronze

Example: **MP-LED542-BI/BN**

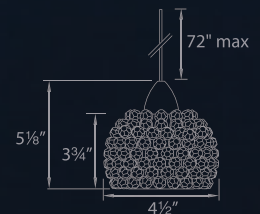

Quick Adjust™ Canopy

Canopy models include Quick Adjust™ canopy
 Quick Connect™ models require additional adapter

Kalysta | Eternity Jewelry Collection **NEW**

Lamping: LED 12V Xenon BP-50
Power: 6.4W 50 W Max
Lumens: 450
Color Temp: 3000K
CRI: 85



Shown: **QP-LED938-WD/DB**



Shown: **QP-LED938-BI/CH**



Shown: **QP-LED938-CD/BN**

PENDANT | QUICK CONNECT™

System	Model	Lamping	Shade Finish	Socket Finish
MP Canopy	LED938 938	LED Xenon	BI Black Ice	BN Brushed Nickel
QP Quick Connect™			CD Champagne Diamond	CH Chrome
			WD White Diamond (Clear)	DB Dark Bronze

Example: **QP-LED938-WD/DB**



Quick Adjust™ Canopy

Canopy models include Quick Adjust™ canopy
 Quick Connect™ models require additional adapter

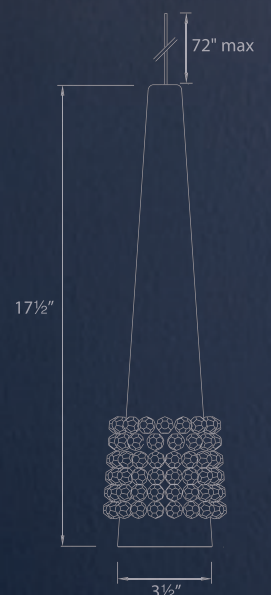

Sorriso | Eternity Jewelry Collection **NEW**

Lamping: LED
 Power: 5.7W
 Lumens: 165
 Color Temp: 3000K
 CRI: 85

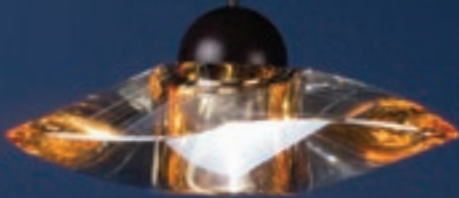

Shown: QP-LED336-GL/DB



Shown: QP-LED336-SM/BN



Shown: QP-LED336-CL/CH

PENDANT | QUICK CONNECT™

System	Name	Color	Finish
MP Canopy	LED336 LED	CL Clear	BN Brushed Nickel
QP Quick Connect™		GL Gold	CH Chrome
		SM Smoke	DB Dark Bronze

Example: **MP-LED336-GL/BN**

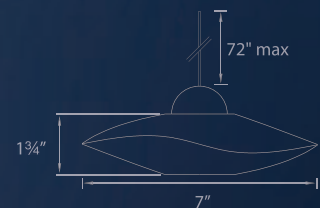

Quick Adjust™ Canopy

Canopy models include Quick Adjust™ canopy
 Quick Connect™ models require additional adapter

Candy | European Collection **NEW**

Lamping: LED 12V Xenon BP-50
Power: 4W 50 W Max
Lumens: 330
Color Temp: 3000K
CRI: 85



Shown: QP-LED544-SL/CH



Shown: QP-LED544-CL/CH



Shown: QP-LED544-GL/CH

PENDANT | QUICK CONNECT™

System	Model	Lamping	Shade Finish	Socket Finish
MP Canopy	LED544 544	LED	CL Clear	BN Brushed Nickel
QP Quick Connect™		Xenon	GL Gold SL Silver	CH Chrome DB Dark Bronze

Example: **MP-LED544-GL/BN**

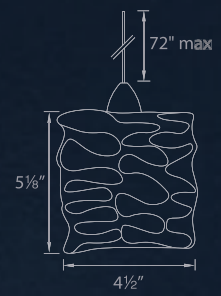

Quick Adjust™ Canopy

Canopy models include Quick Adjust™ canopy
 Quick Connect™ models require additional adapter

Lucia | European Collection **NEW**

Lamping: 12V Xenon BP-50
 Power: 50 W Max

PENDANT | QUICK CONNECT™



Shown: **QP-943-BZ/CH**



Shown: **QP-943-GL/CH**

System		Name		Color		Finish	
MP	Canopy	943	Xenon	BZ	Bronze Iride with Gold Trim	BN	Brushed Nickel
QP	Quick Connect™			GL	Gold Iride with Gold Trim	CH	Chrome

Example: **MP-943-GL/CH**

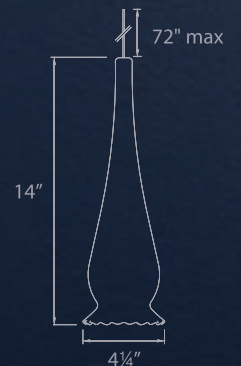

Quick Adjust™ Canopy

Canopy models include Quick Adjust™ canopy
 Quick Connect™ models require additional adapter

Ice | European Collection **NEW**

Lamping: 12V Xenon BP-50
 Power: 50 W Max



Shown: QP-920-CL/CH



Shown: QP-960-CL/CH

PENDANT | QUICK CONNECT™

System	Name	Color	Finish
MP Canopy	920 Xenon with Short glass	CL Clear	BN Brushed Nickel
QP Quick Connect™	960 Xenon with Long glass		CH Chrome
			DB Dark Bronze

Example: **MP-920-CL/BN**

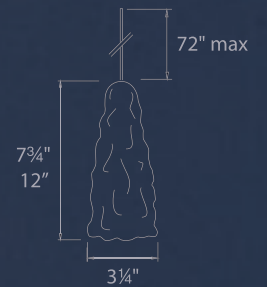

Canopy models include Quick Adjust™ canopy
 Quick Connect™ models require additional adapter



Quick Adjust™ Canopy

Genesis LED Multi-Light Pendants

Power: 9W per fixture
Lumens: 210 per fixture
Color Temp: 3000K
CRI: 85
Dimming: 100% – 15%
Rated Life: 50,000 hours

Includes Pendants, Quick Connect™ mirror canopy and 12 feet of cable per pendant.



PENDANT | QUICK CONNECT™

Genesis combines functional performance with ambient lighting for a truly unique pendant and a stunning decorative accent.

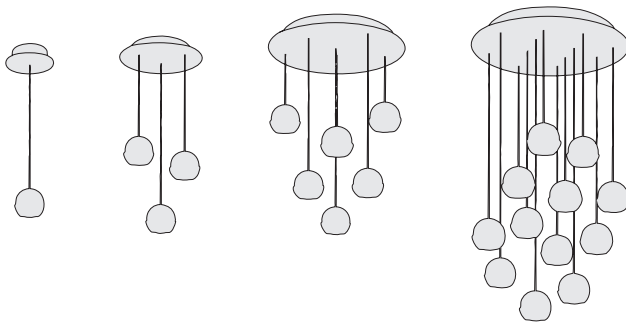

Model	Canopy Finish
QMP-LED311-MR 1-Light	Mirror
QMP-LED311/3-MR 3-Light	
QMP-LED311/6-MR 6-Light	
QMP-LED311/12-MR 12-Light	

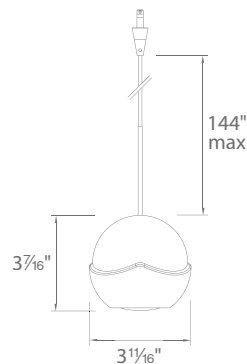



PENDANT | QUICK CONNECT™

Featured Product: QMP-LED311/12-MR

Milford

Lamping: LED
Power: 5.6 W
Lumens: 430
Color Temp: 3000K
CRI: 85

Milford brings out the softer side of school-house pendants with a milky white glass shade that radiates charm and nostalgia.

System	Model	Color	Finish
MP Canopy	LED492	WT White	BN Brushed Nickel
QP Quick Connect			CH Chrome
			DB Dark Bronze

Example: **MP- LED492-WT/DB**

Canopy models include Quick Adjust™ canopy.
 Quick Connect™ models require additional adapter.

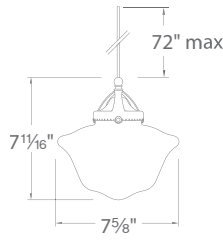

Quick Adjust™ Canopy

Sheffield

Lamping: LED
Power: 5.6 W
Lumens: 430
Color Temp: 3000K
CRI: 85

Sheffield features a classic ginger jar style with a milky white cased glass, soft curves and fresh profile.

System	Model	Color	Finish
MP Canopy	LED493	WT White	BN Brushed Nickel
QP Quick Connect			CH Chrome
			DB Dark Bronze

Example: **MP- LED493-WT/CH**

Canopy models include Quick Adjust™ canopy.
 Quick Connect™ models require additional adapter.

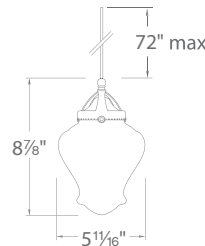

Quick Adjust™ Canopy

Cambridge

Lamping: LED
Power: 5.6 W
Lumens: 430
Color Temp: 3000K
CRI: 85

Cambridge is intricately sculpted of faceted crystal with meticulous attention to detail.

System	Model	Color	Finish
MP Canopy	LED491	CL Clear	BN Brushed Nickel
QP Quick Connect			CH Chrome
			DB Dark Bronze

Example: **MP- LED491-CL/CH**

Canopy models include Quick Adjust™ canopy.
 Quick Connect™ models require additional adapter.

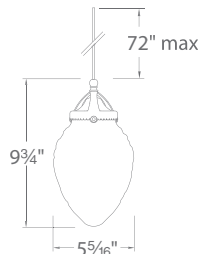

Quick Adjust™ Canopy

Plymouth

Lamping: LED
Power: 5.6 W
Lumens: 430
Color Temp: 3000K
CRI: 85

Plymouth is handcrafted of mouth-blown milky white opal glass with hand-painted silver bands for a timeless look.

System	Model	Color	Finish
MP Canopy	LED494	SL Silver	BN Brushed Nickel
QP Quick Connect			CH Chrome
			DB Dark Bronze

Example: **MP-LED494-SL/CH**

Canopy models include Quick Adjust™ canopy.
 Quick Connect™ models require additional adapter.

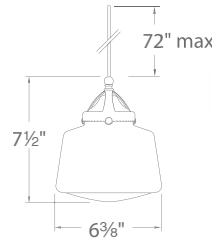

Quick Adjust™ Canopy

Mirabel

Lamping: LED
Power: 5.6 W
Lumens: 430
Color Temp: 3000K
CRI: 85

Mirabel spins a new twist on a classic design with subtle yet stylish opal cased glass.

System	Model	Color	Finish
MP Canopy	LED495	WT White	BN Brushed Nickel
QP Quick Connect			CH Chrome
			DB Dark Bronze

Example: **MP-LED495-WT/CH**

Canopy models include Quick Adjust™ canopy.
 Quick Connect™ models require additional adapter.

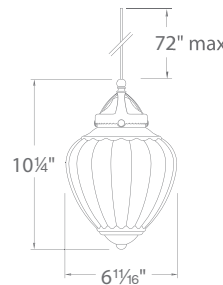

Quick Adjust™ Canopy

Mason

Lamping: LED
Power: 5.6 W
Lumens: 430
Color Temp: 3000K
CRI: 85

Mason is a whimsical piece of an iconic symbol of functionality.

System	Model	Color	Finish
MP Canopy	LED497	CL Clear	BN Brushed Nickel
QP Quick Connect			CH Chrome
			DB Dark Bronze

Example: **MP-LED497-CL/BN**

Canopy models include Quick Adjust™ canopy.
 Quick Connect™ models require additional adapter.

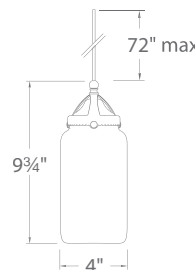

Quick Adjust™ Canopy

PENDANT | QUICK CONNECT™

Madison

Lamping: LED
Power: 5.6 W
Lumens: 430
Color Temp: 3000K
CRI: 85

Madison is like a frosty winter windowpane with a distinctive crackled glass cylinder that sparkles in the light.

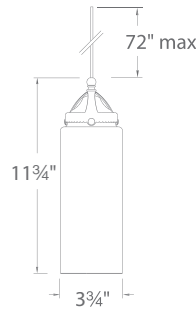

Quick Adjust™ Canopy

System	Model	Color	Finish
MP Canopy	LED499	CR Clear Crackled	BN Brushed Nickel
QP Quick Connect			CH Chrome
			DB Dark Bronze

Example: **MP-LED499-CR/CH**

Canopy models include Quick Adjust™ canopy.
 Quick Connect™ models require additional adapter.

PENDANT | QUICK CONNECT™

Huntington

Lamping: LED
Power: 5.6 W
Lumens: 430
Color Temp: 3000K
CRI: 85

The bungalow styling of this pendant brings a quaint charm to your home.

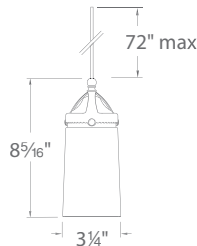

Quick Adjust™ Canopy

System	Model	Color	Finish
MP Canopy	LED498	AM Amber	BN Brushed Nickel
QP Quick Connect			CH Chrome
		WT White	DB Dark Bronze

Example: **MP-LED498-AM/CH**

Canopy models include Quick Adjust™ canopy.
 Quick Connect™ models require additional adapter.

Artemis

Lamping: LED
Power: 5.6 W
Lumens: 430
Color Temp: 3000K
CRI: 85

Artemis is a nostalgic design handcrafted with an iridescent sheen and blown into a gracefully lustrous form.

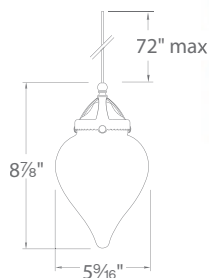

Quick Adjust™ Canopy

System	Model	Color	Finish
MP Canopy	LED496	IR Iridescent	BN Brushed Nickel
QP Quick Connect			CH Chrome
			DB Dark Bronze

Example: **MP-LED496-IR/DB**

Canopy models include Quick Adjust™ canopy.
 Quick Connect™ models require additional adapter.

Wyandotte

Lamping: LED
Power: 5.6 W
Lumens: 430
Color Temp: 3000K
CRI: 85

Wyandotte features a handsome, industrial design with authentic metal hardware.



System	Model	Color	Finish
MP Canopy	LED483	AB Antique Bronze	BN Brushed Nickel
QP Quick Connect		BN Brushed Nickel	CH Chrome
			DB Dark Bronze

Example: **MP-LED483-BN/BN**

Canopy models include Quick Adjust™ canopy.
 Quick Connect™ models require additional adapter.

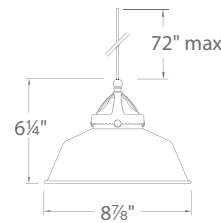

Quick Adjust™ Canopy

PENDANT | QUICK CONNECT™

Freeport

Lamping: LED
Power: 5.6 W
Lumens: 430
Color Temp: 3000K
CRI: 85

Freeport captures the industrial look of yester-year in a well-proportioned design with thick-walled glass and beautiful finishes.



System	Model	Color	Finish
MP Canopy	LED481	AB Antique Bronze	BN Brushed Nickel
QP Quick Connect		BN Brushed Nickel	CH Chrome
			DB Dark Bronze

Example: **MP-LED481-BN/BN**

Canopy models include Quick Adjust™ canopy.
 Quick Connect™ models require additional adapter.

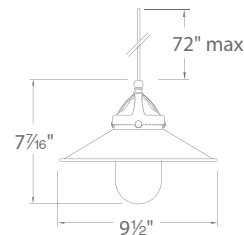

Quick Adjust™ Canopy

Willow

Lamping: 12V Xenon BP-50
Power: 50 W max

Willow's beautiful strokes of blue run down the length of this gorgeous pendant like the branches of a delicate willow tree.

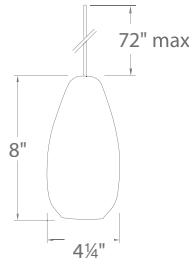

System	Model	Color	Finish
MP Canopy	954	IR Iridescent	BN Brushed Nickel
QP Quick Connect			CH Chrome
			DB Dark Bronze

Example: **MP-954-IR/DB**

Canopy models include Quick Adjust™ canopy.
 Quick Connect™ models require additional adapter.



Quick Adjust™ Canopy

PENDANT | QUICK CONNECT™

Ginkgo

Lamping: LEDme® Low Voltage
 LED 12V halogen JC-50
Power: 4 W 50 W max
Lumens: 330
Color Temp: 3000K
CRI: 85

Ginkgo's background of blue, green, rose and gold shades seems to disappear when illuminated and the patterns float tone on tone.

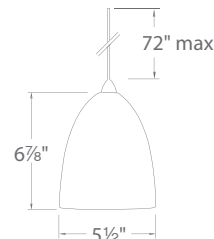

System	Model	Color	Finish
MP Canopy	LED538 LEDme®	IR Iridescent	BN Brushed Nickel
QP Quick Connect	538 Low Voltage		CH Chrome
			DB Dark Bronze

Example: **MP-LED538-IR/DB**

Canopy models include Quick Adjust™ canopy.
 Quick Connect™ models require additional adapter.



Quick Adjust™ Canopy

Fügü

Lamping: 12V Xenon BP-50
Power: 50 W max

The Japanese blowfish, Fügü is mouth-blown Italian glass embedded with 24K gold flecks and sparkling hand-pulled spikes.



System	Model	Color	Finish
MP Canopy	924	GL Gold	BN Brushed Nickel
QP Quick Connect			CH Chrome
			DB Dark Bronze

Example: **MP-924-GL/CH**

Canopy models include Quick Adjust™ canopy.
 Quick Connect™ models require additional adapter.

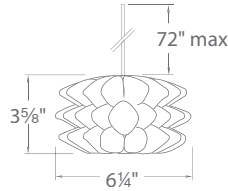

Quick Adjust™ Canopy

Rococo

Lamping: 12V Xenon BP-50
Power: 50 W max

The Rococo pendant features amber and opal frit, richly layered in speckles of gold to add a distinctive touch of elegance to any space.



System	Model	Color	Finish
MP Canopy	935	GL Gold	BN Brushed Nickel
QP Quick Connect			CH Chrome
			DB Dark Bronze

Example: **MP-935-GL/DB**

Canopy models include Quick Adjust™ canopy.
 Quick Connect™ models require additional adapter.

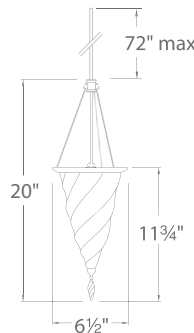

Quick Adjust™ Canopy

PENDANT | QUICK CONNECT™

Florentine

Lamping: LEDme® Low Voltage
Power: LED 12V halogen JC-50
Lumens: 4 W 50 W max
Color Temp: 330
CRI: 3000K 85



The Florentine pendant is hand crafted Italian glass depicting a delicate floral profile.

System	Model	Color	Finish
MP Canopy	LED531 LEDme®	FR Frosted	BN Brushed Nickel
QP Quick Connect	531 Low Voltage		CH Chrome
			DB Dark Bronze

Example: **MP-LED531-FR/BN**

Canopy models include Quick Adjust™ canopy.
 Quick Connect™ models require additional adapter.

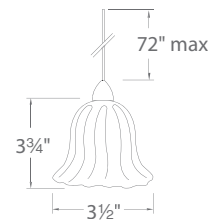

Quick Adjust™ Canopy

PENDANT | QUICK CONNECT™

Gem

Lamping: LED
Power: 3.7 W
Lumens: 165
Color Temp: 3000K
CRI: 85



Gem is meticulously crafted with hand carved dimples that glow with millions of sparkles.

System	Model	Color	Finish
MP Canopy	LED334	CL Clear	BN Brushed Nickel
QP Quick Connect			CH Chrome
			DB Dark Bronze

Example: **MP-LED334-CL/CH**

Canopy models include Quick Adjust™ canopy.
 Quick Connect™ models require additional adapter.

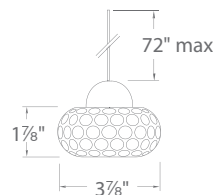

Quick Adjust™ Canopy

Brittany

	LEDme®	Low Voltage
Lamping:	LED	12V halogen JC-50
Power:	3.7 W	50 W max
Lumens:	165	
Color Temp:	3000K	
CRI:	85	

Brittany is crafted using layers of classic Italian opaline glass that blossom into a dramatic opalescent flower.



System	Model	Color	Finish
MP Canopy	LED333 LEDme®	OP Opaline	BN Brushed Nickel
QP Quick Connect	333 Low Voltage		CH Chrome
			DB Dark Bronze

Example: **MP-LED333-OP/BN**

Canopy models include Quick Adjust™ canopy.
Quick Connect™ models require additional adapter.

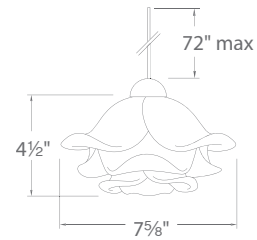

Quick Adjust™ Canopy

PENDANT | QUICK CONNECT™

Mini Brittany

	LEDme®	Low Voltage
Lamping:	LED	12V halogen JC-50
Power:	4 W	50 W max
Lumens:	330	
Color Temp:	3000K	
CRI:	85	

Mini Brittany is crafted using layers of classic Italian opaline glass that blossom into a dramatic opalescent flower.



System	Model	Color	Finish
MP Canopy	LED533 LEDme®	OP Opaline	BN Brushed Nickel
QP Quick Connect	533 Low Voltage		CH Chrome
			DB Dark Bronze

Example: **MP-LED531-OP/BN**

Canopy models include Quick Adjust™ canopy.
Quick Connect™ models require additional adapter.

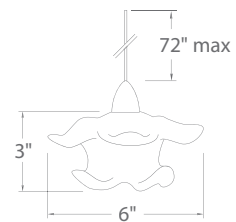







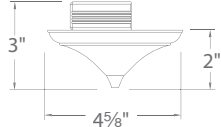

Quick Adjust™ Canopy

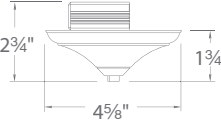
Quick Adjust™ and Quick Connect™ Canopies

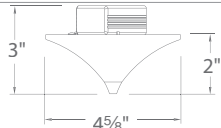
Minimum Load: 1W
Maximum Load: 50W

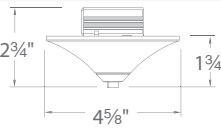

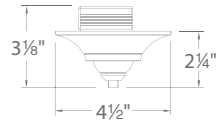



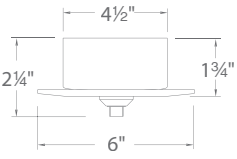

Quick Adjust™ reserves up to 4" of adjustability to pendant height within canopy
 Quick Connect™ for use with QP and QF system elements

			Model	Finish
Quick Adjust™			MP60E-1	AB <i>Antique Bronze</i> BN <i>Brushed Nickel</i> CH <i>Chrome</i>
Quick Connect™			QMP60ERN-1	
Quick Adjust™			MP60E	BN <i>Brushed Nickel</i> CH <i>Chrome</i> DB <i>Dark Bronze</i>
Quick Connect™			QMP60ERN	
Quick Connect™ Sloped Ceiling			QMP-S60ERN	

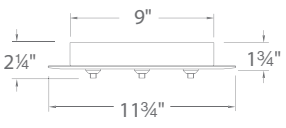
Example: **QMP-S60ERN-BN**

PENDANT | QUICK CONNECT™

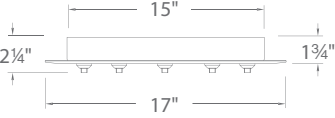
Quick Connect™ Mirror Canopies

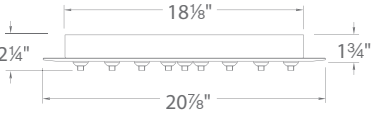
			Model
1-Point	Round	 	QMP-G1RN-MR
3-Point	Round	 	QMP-G3RN-MR
	Rectangle	 	QMP-G3RE-MR
6-Point	Round	 	QMP-G6RN-MR
12-Point	Round	 	QMP-G12RN-MR

LED Lamps

JC Bi-Pin

Model

JCLEd-2-30-WT

Compatible with our incandescent xenon or halogen pendants.



Power: 2.1W
Base: G5.3
Volt: 12V
Lumens: 110
Color Temp: 3000K

CRI: 85
Dimming: 100% – 10%
Life: 30,000 hours
Dimension: Ø1¹/₁₆" × 2³/₁₆"

MR16

Model

Finish

MR16LED-BAB

**BK
WT**



Power: 8W
Base: GU5.3
Volt: 12V
Lumens: 450
Color Temp: 3000K

CRI: 85
Dimming: Yes
Life: 25,000 hours
Dimension: Ø2" × 1"

GU10

Model

Finish

GU10LED-BAB

**BK
WT**



Power: 8W
Base: GU10
Volt: 120V
Lumens: 470
Color Temp: 3000K

CRI: 82
Dimming: Not Dimmable
Life: 25,000 hours
Dim.: Ø2" × 2¹/₁₆"

PAR20

Model

Finish

PAR20LED-10N30

**BK
WT**



Power: 10.3W
Base: med
Volt: 120V
Lumens: 450
Color Temp: 3000K

CRI: 80
Dimming: 100% – 20%
Life: 25,000 hours
Dimension: Ø2¹/₂" × 3⁷/₁₆"

PAR30

Model

Finish

PAR30LED-L14N30

**BK
WT**



Power: 14.6W
Base: med
Volt: 120V
Lumens: 600
Color Temp: 3000K

CRI: 80
Dimming: 100% – 20%
Life: 25,000 hours
Dimension: Ø3³/₄" × 4³/₄"

PAR38

Model

Finish

PAR38LED-17N30

**BK
WT**



Power: 17.8W
Base: med
Volt: 120V
Lumens: 825
Color Temp: 3000K

CRI: 80
Dimming: 100% – 20%
Life: 25,000 hours
Dimension: Ø4¹³/₁₆" × 5³/₁₆"

BR20

Model

BR20LED-7N27-WT



Power: 7.5W
Base: med
Volt: 120V
Lumens: 490
Color Temp: 2700K

CRI: 80
Dimming: 100% – 10%
Life: 40,000 hours
Dimension: Ø2¹/₂" × 3⁷/₈"

BR30

Model

BR30LED-11N27-WT



Power: 14W
Base: med
Volt: 120V
Lumens: 830
Color Temp: 2700K

CRI: 80
Dimming: 100% – 10%
Life: 40,000 hours
Dimension: Ø3³/₄" × 5³/₁₆"

BR40

Model

BR40LED-15N27-WT



Power: 17W
Base: med
Volt: 120V
Lumens: 1180
Color Temp: 2700K

CRI: 80
Dimming: 100% – 10%
Life: 40,000 hours
Dimension: Ø4⁷/₈" × 5¹³/₁₆"



dwelLED™

by WAC Lighting

LED technology becomes accessible for decorative luminaires, with transitional styling and 2700K warm white light for even the most demanding applications.

dwelLED™ decorative LED luminaires are designed to integrate within a variety of spaces ranging from multi-family residential to commercial and healthcare. Options include ADA compliance, ELV dimming, 277 volt power, wet location, and a variety of sizes and finishes.

The dwelLED collection incorporates indoor and outdoor sconces, vanities, swing-arm reading lights, ceiling-mount lights, picture lights, and chandeliers, all engineered optimally for energy efficient LEDs.

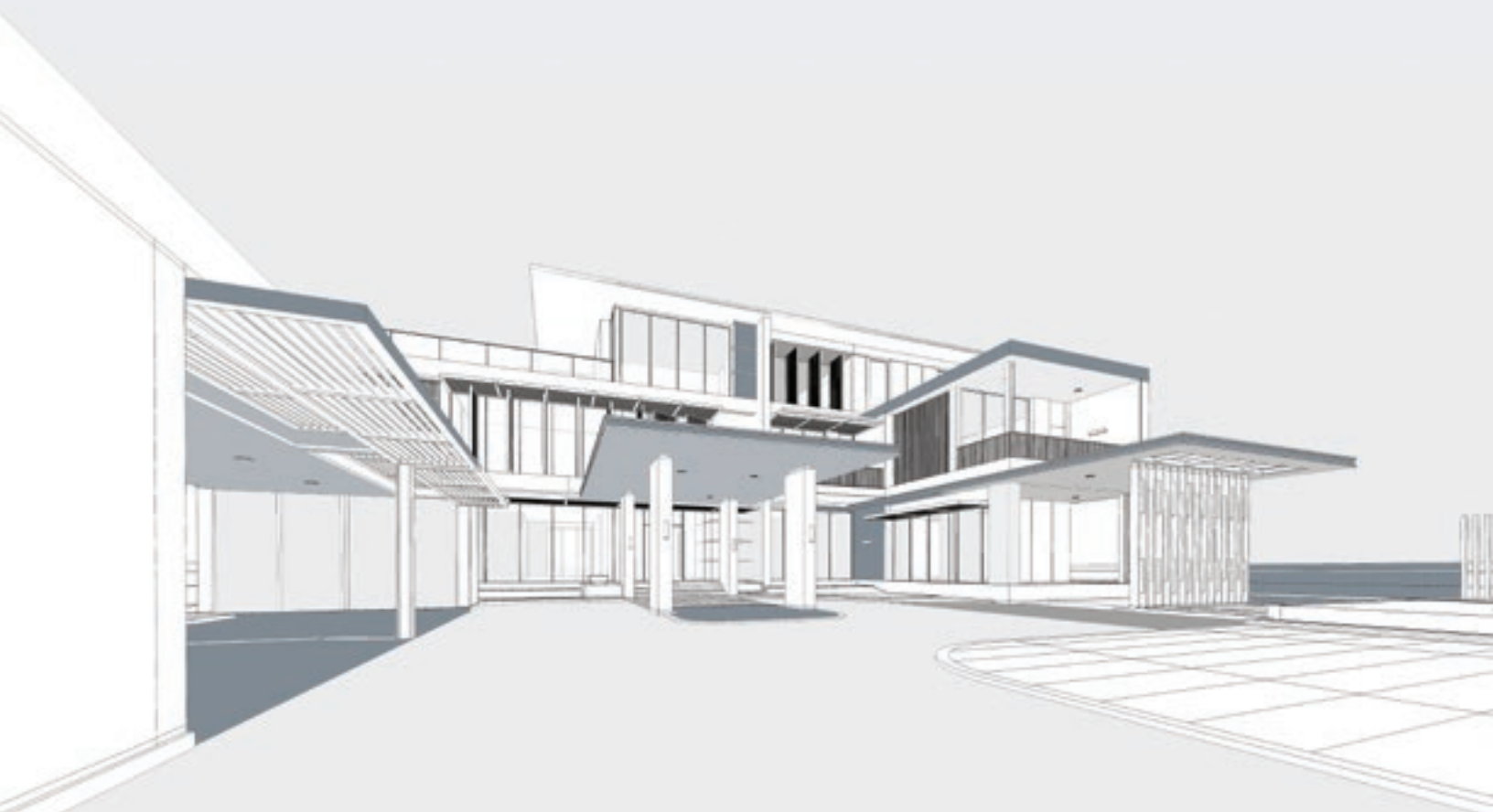

Rocket I Pendant **NEW**



PENDANT | **dwelLED™**

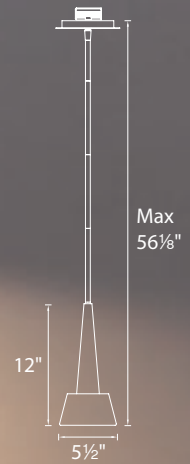

Color Temp: 2700K
 CRI: 85
 Dimming: 100% – 10%
 Rated Life: 50,000 hours

- Upscale quality plated metal finishes
- Three 12 inch and one 6 inch rods included
- Dim with electronic low voltage (ELV) dimmer
- ETL damp location listed
- 277V available (special order)



	Watt	LED Lumens	Delivered Lumens	Finish
 <p>PD-51712</p>	12 W	915	245	BN <i>Brushed Nickel</i> CH <i>Chrome</i> LB <i>Light Bronze</i> 

Example: **PD-51712-BN**
 For 277V, add an "F" before the finish: **PD-51712F-BN**

Flair | Pendant **NEW**



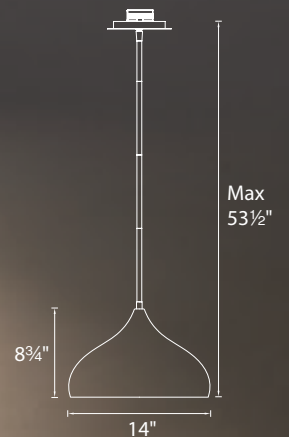

Color Temp: 2700K
CRI: 85
Dimming: 100% – 10%
Rated Life: 50,000 hours

- Mouth blown and etched opal LED shield
- Three 12 inch and one 6 inch rods included
- Dim with electronic low voltage (ELV) dimmer
- ETL damp location listed
- 277V available (special order)



PENDANT | **dweLED™**

	Watt	LED Lumens	Delivered Lumens	Finish
	14 W	1000	480	BO <i>Brushed Bronze</i> BN <i>Brushed Nickel</i> LB <i>Light Bronze</i> 
PD-52214				

Example: **PD-52214-BN**

For 277V, add an "F" before the finish: **PD-52214F-BN**

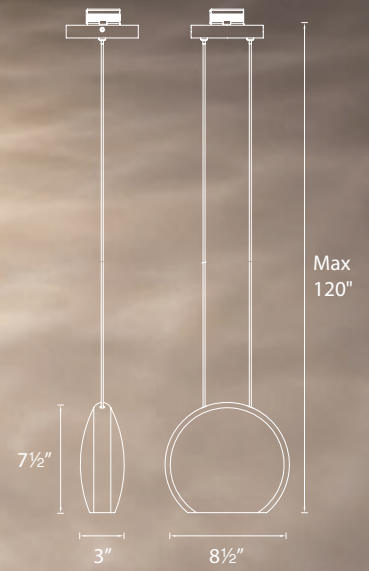

Lolli I Pendant **NEW**

PENDANT | **dwelLED™**



Color Temp: 2700K
 CRI: 85
 Dimming: 100% – 10%
 Rated Life: 50,000 hours

- Unique oval bronze glass pendant with hammered optic
- Dim with electronic low voltage (ELV) dimmer
- Cable suspension may be field shortened
- ETL damp location listed

		Watt	LED Lumens	Delivered Lumens	Finish
	PD-52008	6.5W	313	185	CH Chrome 

Example: **PD-52008-CH**

Niveous I Pendant **NEW**



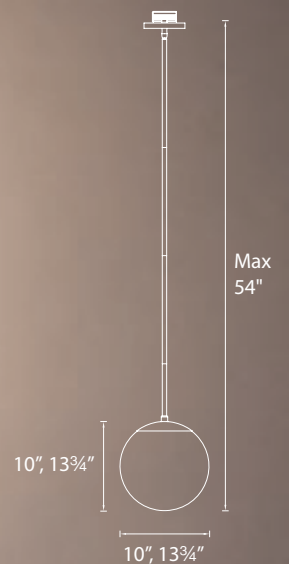

Color Temp: 2700K
CRI: 85
Dimming: 100% – 10%
Rated Life: 50,000 hours

- Mouth blown etched opal glass
- Three 12 inch and one 6 inch rods included
- Dim with electronic low voltage (ELV) dimmer
- ETL damp location listed
- 277V available (special order)



PENDANT | **dweLED™**

			Watt	LED Lumens	Delivered Lumens	Finish
	<i>Small</i>	10"	PD-52310	14W	1000	755
						BN <i>Brushed Nickel</i> WT <i>White</i>
	<i>Large</i>	13"	PD-52313	14W	1000	795
						

Example: **PD-52310-WT**
 For 277V, add an "F" before the finish: **PD-52310F-WT**

Kiss | Pendant **NEW**

PENDANT | **dwelLED™**

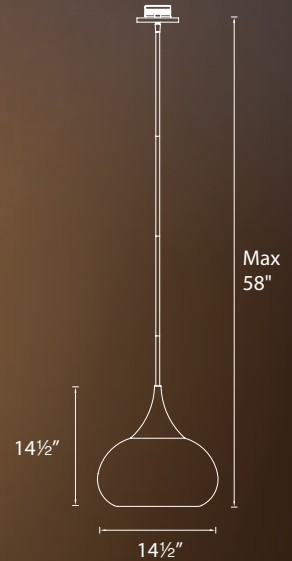

Color Temp: 2700K
 CRI: 85
 Dimming: 100% – 10%
 Rated Life: 50,000 hours

- Classic glass pendant with concave bottom
- Three 12 inch and one 6 inch rods included
- Dim with electronic low voltage (ELV) dimmer
- ETL damp location listed
- 277V available (special order)

		Watt	LED Lumens	Delivered Lumens	Finish
	PD-51814	14W	1000	935	BR <i>Brushed Brass</i>
					BN <i>Brushed Nickel</i>
					CH <i>Chrome</i>

Example: **PD-51814-BR**
 For 277V, add an "F" before the finish: **PD-51814F-BR**

Eliptic I Pendant **NEW**



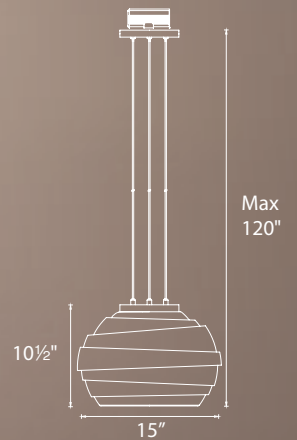

Color Temp: 2700K
 CRI: 85
 Dimming: 100% – 10%
 Rated Life: 50,000 hours

- Unique glass pendant with banded glass details
- Dim with electronic low voltage (ELV) dimmer
- Cable suspension may be field shortened
- ETL damp location listed
- 277V available (special order)



PENDANT | **dweLED™**

		Watt	LED Lumens	Delivered Lumens	Finish
	PD-51915	14W	1000	815	BN <i>Brushed Nickel</i> 

Example: **PD-51915-BN**
 For 277V, add an "F" before the finish: **PD-51915F-BN**

Line I Pendant **NEW**





PENDANT | **dwelLED™**

Color Temp: 2700K
 CRI: 85
 Dimming: 100% – 10%
 Rated Life: 50,000 hours

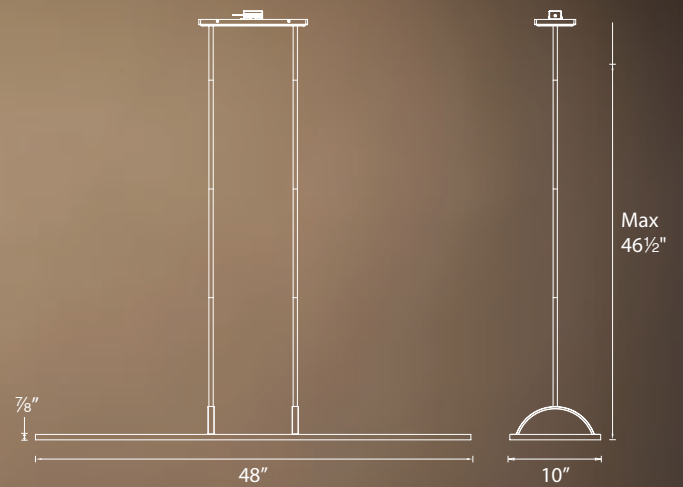
- Super thin, edge-lit LED panel illuminates up and down
- Six 12 inch and two 6 inch rods included
- Dim with electronic low voltage (ELV) dimmer
- ETL damp location listed



		Watt	LED Lumens	Delivered Lumens	Finish
	PD-51148	48W	4435	2770	AL <i>Brushed Aluminum</i> 

Example: **PD-51148-AL**





Line I Vanities **NEW**

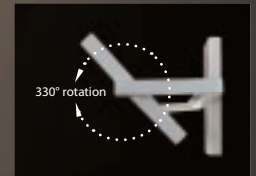
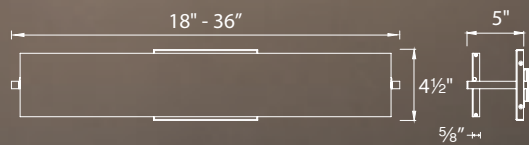

Color Temp: 2700K
 CRI: 85
 Dimming: 100% – 10%
 Rated Life: 50,000 hours

- Super thin, edge-lit LED panel
- Vertical or horizontal mount with 330° adjustment
- Dim with electronic low voltage (ELV) dimmer
- ETL damp location listed



		Length	Watt	LED Lumens	Delivered Lumens	Finish
	Small	18" WS-6718	14.5W	1109	690	AL Brushed Aluminum 
	Medium	24" WS-6724	20W	1478	1015	
	Large	36" WS-6736	27.5W	2118	1220	

Example: **WS-6724-AL**

Sonoma | Vanities **NEW**



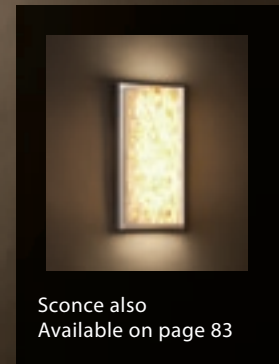
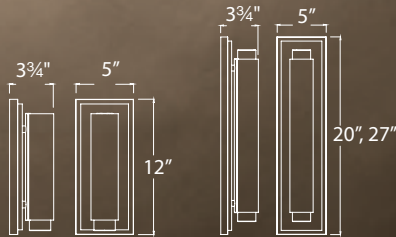

Color Temp: 2700K
 CRI: 85
 Dimming: 100% – 10%
 Rated Life: 50,000 hours

- Tiled shell accents
- ADA compliant
- Mouth blown etched opal glass
- Vertical or horizontal mount
- Dim with electronic low voltage (ELV) dimmer
- ETL damp location listed
- No driver or transformer needed
- 277V available (special order)



VANITIES | **dweLED™**

		Length		Watt	LED Lumens	Delivered Lumens	Finish
	<i>Small</i>	12"	WS-6312	7.5W	653	375	
	<i>Medium</i>	20"	WS-6320	13.5W	1082	770	CH Chrome 
	<i>Large</i>	27"	WS-6327	17.5W	1486	955	

Example: **WS-6312-CH**
 For 277V, add an "F" before the finish: **WS-6312F-CH**

Vie | Vanities **NEW**







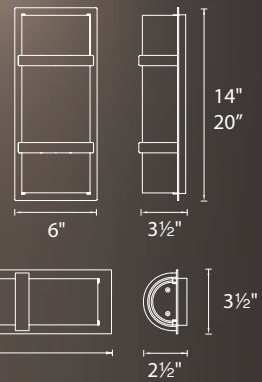

Color Temp: 2700K
CRI: 85
Dimming: 100% – 10%
Rated Life: 50,000 hours

- Vertical or horizontal mount
- Bath lights have 3 inch wide format for narrow applications
- Conversion plate for 4" J box included
- Dim with electronic low voltage (ELV) dimmer
- ETL damp location listed
- No driver or transformer needed
- 277V available (special order)



VANITIES | **dweLED™**

		Length	Watt	LED Lumens	Delivered Lumens	Finish
	Wall Sconce	14" WS-6614	18.5W	1615	830	BN Brushed Nickel CH Chrome 
	Wall Sconce	20" WS-6620	24.5W	2037	1145	
	Bath Light	18" WS-6618	25.5W	2037	1200	
	Bath Light	24" WS-6624	35W	2849	1750	
	Bath Light	36" WS-6636	55W	4463	2605	

Example: **WS-6614-BN**
 For 277V, add an "F" before the finish: **WS-6614F-BN**

Bristol | Vanities NEW





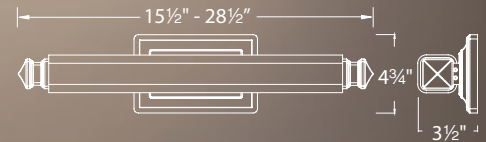
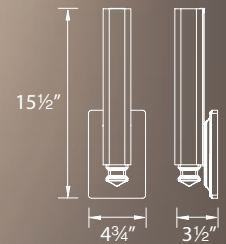

Color Temp: 2700K
 CRI: 85
 Dimming: 100% – 10%
 Rated Life: 50,000 hours

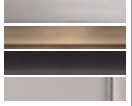

- Four finishes to complement most bath hardware
- Vertical or horizontal mount
- ADA compliant
- No driver or transformer needed
- Dim with electronic low voltage (ELV) dimmer
- ETL damp location listed
- 277V available (special order)

VANITIES | **dweLED™**

		Length		Watt	LED Lumens	Delivered Lumens	Finish
	<i>Small</i>	15"	WS-7115	19W	1615	1090	
	<i>Medium</i>	20"	WS-7120	25.5W	2037	1485	AN <i>Antique Nickel</i> BB <i>Burnished Brass</i> BO <i>Brushed Bronze</i> PN <i>Polished Nickel</i> 
	<i>Large</i>	28"	WS-7128	37.5W	3229	2135	

Example: **WS-7120-AN**
 For 277V, add an "F" before the finish: **WS-7120F-AN**

Astoria | Vanities **NEW**



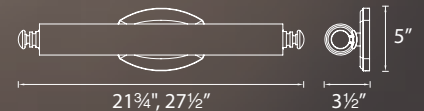
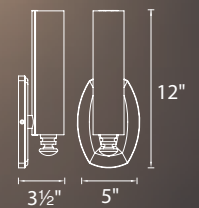

Color Temp: 2700K
CRI: 85
Dimming: 100% – 10%
Rated Life: 50,000 hours

- Four finishes to complement most bath hardware
- Vertical or horizontal mount
- ADA Compliant
- Dim with electronic low voltage (ELV) dimmer
- ETL damp location listed
- No driver or transformer needed
- 277V available (special order)



VANITIES | **dweLED™**

		Length	Watt	LED Lumens	Delivered Lumens	Finish
	<i>Small</i>	12"	WS-7012	15W	1234	725
	<i>Medium</i>	22"	WS-7022	31.5W	2468	1780
	<i>Large</i>	27"	WS-7027	38W	3229	2155

AN *Antique Nickel*
BB *Burnished Brass*
BO *Brushed Bronze*
PN *Polished Nickel*



Example: **WS-7022-BO**
 For 277V, add an "F" before the finish: **WS-7022F-BO**

Svelte | Vanities NEW





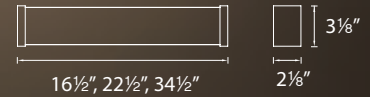

Color Temp: 2700K
CRI: 85
Dimming: 100% – 10%
Rated Life: 50,000 hours

VANITIES | **dweILED™**

- Mitered glass construction
- Vertical or horizontal mount
- ADA compliant
- No driver or transformer needed
- Dim with electronic low voltage (ELV) dimmer
- ETL damp location listed
- Conversion plate for 4" J box included
- 277V available (special order)



		Length		Watt	LED Lumens	Delivered Lumens	Finish
	<i>Small</i>	16"	WS-7316	24.5W	2037	965	BN <i>Brushed Nickel</i> CH <i>Chrome</i> 
	<i>Medium</i>	22"	WS-7322	34.5W	2849	1490	
	<i>Large</i>	34"	WS-7334	48W	4463	2320	

Example: **WS-7316-CH**

For 277V, add an "F" before the finish: **WS-7316F-CH**

Elemental | Vanities **NEW**

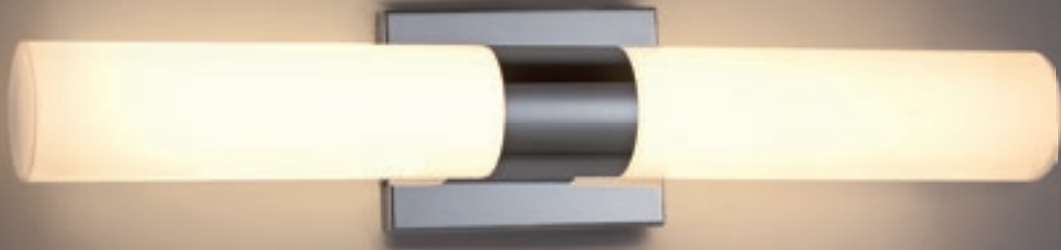



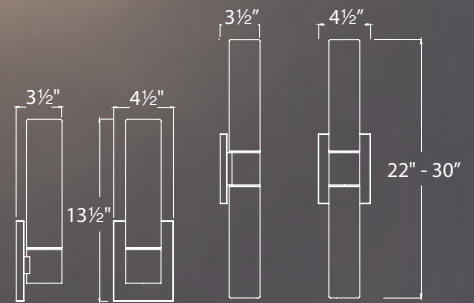

Color Temp: 2700K
CRI: 85
Dimming: 100% – 10%
Rated Life: 50,000 hours

- ETL wet location listed
- ADA Compliant
- Two finishes to complement most bath hardware
- Vertical or horizontal mount
- No driver or transformer needed
- Dim with electronic low voltage (ELV) dimmer
- 277V available (special order)



VANITIES | **dweILED™**

		Length		Watt	LED Lumens	Delivered Lumens	Finish
	<i>Small</i>	13"	WS-7213	15.5W	1234	805	
	<i>Medium</i>	22"	WS-7222	30.5W	2468	1660	BN Brushed Nickel CH Chrome 
	<i>Large</i>	30"	WS-7230	39.5W	3229	2155	

Example: **WS-7220-BN**

For 277V, add an "F" before the finish: **WS-7220F-BN**

Sonoma | Wall NEW

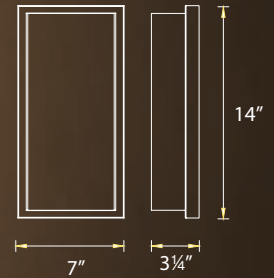

WALL | **dweLED™**

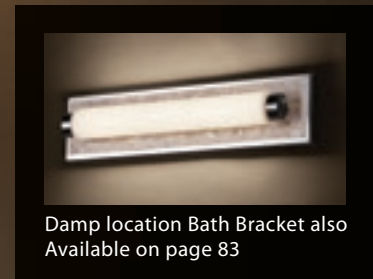

Color Temp: 2700K
 CRI: 85
 Dimming: 100% – 10%
 Rated Life: 50,000 hours

- Tiled shell accents
- ADA compliant
- ETL damp location listed
- Dim with electronic low voltage (ELV) dimmer
- No driver or transformer needed
- 277V available (special order)



		Watt	LED Lumens	Delivered Lumens	Finish
	WS-12214	38.5W	3229	1335	CH Chrome 

Example: **WS-12214-CH**
 For 277V, add an "F" before the finish: **WS-12214F-CH**

Stella | Wall **NEW**





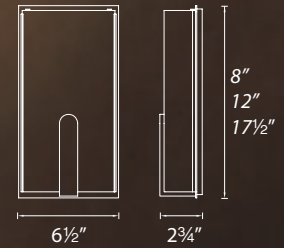

Color Temp: 2700K
CRI: 85
Dimming: 100% – 10%
Rated Life: 50,000 hours

- ADA compliant
- ETL damp location listed
- Dim with electronic low voltage (ELV) dimmer
- No driver or transformer needed
- 277V available (special order)



WALL | dwelLED™

		Height		Watt	LED Lumens	Delivered Lumens	Finish
	<i>Small</i>	8"	WS-13208	9.5W	803	375	BN <i>Brushed Nickel</i> 
	<i>Medium</i>	12"	WS-13212	15.5W	1234	545	
	<i>Large</i>	17"	WS-13217	25.5W	2037	990	

Example: **WS-13207-BN**
 For 277V, add an "F" before the finish: **WS-13207F-BN**

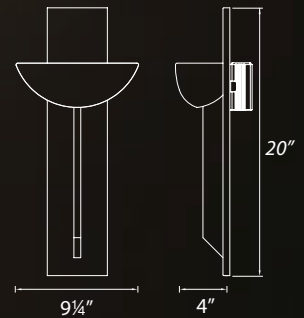

Emblem | Wall NEW

WALL | **dweLED™**



Color Temp: 2700K
CRI: 85
Dimming: 100% – 10%
Rated Life: 50,000 hours

- Brushed metal finish
- ADA compliant
- Dim with electronic low voltage (ELV) dimmer
- ETL damp location listed
- 277V available (special order)

		Watt	LED Lumens	Delivered Lumens	Finish
	WS-13020	10.5W	626	415	BN <i>Brushed Nickel</i>
					

Example: **WS-13020-BN**

For 277V, add an "F" before the finish: **WS-13020F-BN**

Mythical | Wall **NEW**





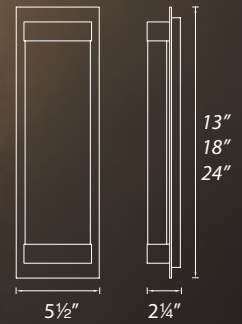

Color Temp: 2700K
CRI: 85
Dimming: 100% – 10%
Rated Life: 50,000 hours

- Seeded glass block
- ADA compliant
- Dim with electronic low voltage (ELV) dimmer
- No driver or transformer needed
- ETL damp location listed
- 277V available (special order)



WALL | dwelLED™

		Height		Watt	LED Lumens	Delivered Lumens	Finish
	Small	13"	WS-12713	5.5W	415	75	PN Polished Nickel 
	Medium	18"	WS-12718	10.5W	830	140	
	Large	24"	WS-12724	10.5W	830	160	

Example: **WS-12718-PN**
 For 277V, add an "F" before the finish: **WS-12718F-PN**

Manhattan | Wall NEW





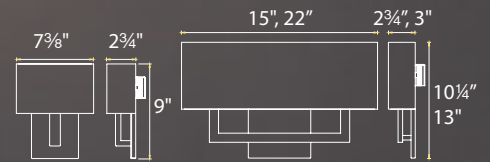

WALL | **dweLED™**

Color Temp: 2700K
 CRI: 85
 Dimming: 100% – 10%
 Rated Life: 50,000 hours

- Cloth shade with etched glass diffuser
- ADA compliant
- Dim with electronic low voltage (ELV) dimmer
- ETL damp location listed
- 277V available (special order)



		Length		Watt	LED Lumens	Delivered Lumens	Finish
	Small	7"	WS-13107	6W	313	125	BN <i>Brushed Nickel</i> BR <i>Brushed Brass</i> BO <i>Brushed Bronze</i> PN <i>Polished Nickel</i> 
	Medium	15"	WS-13115	10.5W	625	280	
	Large	22"	WS-13122	15.5W	940	400	

Example: **WS-13107-BO**
 For 277V, add an "F" before the finish: **WS-13107F-BO**

Chicago | Wall **NEW**



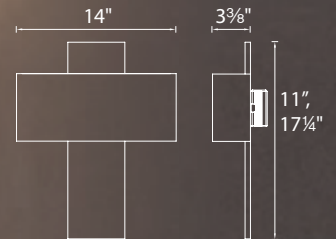

Color Temp: 2700K
CRI: 85
Dimming: 100% – 10%
Rated Life: 50,000 hours

- Cloth shade with etched glass diffuser
- ADA compliant
- Dim with electronic low voltage (ELV) dimmer
- ETL damp location listed
- 277V available (special order)

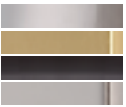

WALL | **dweILED™**

		Height		Watt	LED Lumens	Delivered Lumens	Finish
	<i>Small</i>	11"	WS-12511	20.5W	1250	570	BN <i>Brushed Nickel</i> BR <i>Brushed Brass</i> BO <i>Brushed Bronze</i> PN <i>Polished Nickel</i> 
	<i>Large</i>	17"	WS-12517	20.5W	1250	570	

Example: **WS-12517-BO**
 For 277V, add an "F" before the finish: **WS-12517F-BO**

Slice | Ceiling NEW







CEILING | **dwelLED™**

Color Temp: 2700K, 3000K
CRI: 85
Dimming: 100% – 10%
Rated Life: 50,000 hours

- Mount as a ceiling fixture or wall sconce
- Low profile
- ADA compliant when mounted as wall sconce
- ETL damp location listed
- Dim with electronic low voltage (ELV) dimmer
- Transformer located in j-box
- 277V available (special order)



	Diameter		Color Temp	Watt	LED Lumens	Delivered Lumens	Finish
	Small 9"	FM-4109W	2700K	23W	827	610	BN Brushed Nickel  BZ Bronze  CH Chrome 
			FM-4109	3000K	23W	840	
	Large 11"	FM-4111W	2700K	28W	2128	940	
			FM-4111	3000K	28W	2160	

Example: **FM-4109W-BN**

For 277V, add an "F" before the finish: **FM-4109WF-BN**

Dice | Ceiling NEW





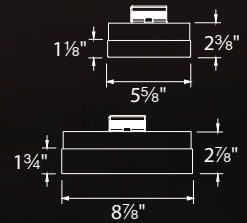

Color Temp: 2700K, 3000K
CRI: 85
Dimming: 100% – 10%
Rated Life: 50,000 hours

- Mount as a ceiling fixture or wall sconce
- Low profile
- ADA compliant when mounted as wall sconce
- ETL damp location listed
- Dim with electronic low voltage (ELV) dimmer
- Transformer located in j-box
- 277V available (special order)



CEILING | **dweLED™**

		Length		Color Temp	Watt	LED Lumens	Delivered Lumens	Finish
	Small	6"	FM-4006W	2700K	16W	709	445	BN Brushed Nickel  BZ Bronze  CH Chrome 
			FM-4006	3000K	16W	720	455	
	Large	9"	FM-4009W	2700K	24W	2128	690	
			FM-4009	3000K	24W	2160	705	

Example: **FM-4009-BN**

For 277V, add an "F" before the finish: **FM-4009F-BN**

Vie | Ceiling NEW

CEILING | **dweLED™**



Color Temp: 2700K
CRI: 85
Dimming: 100% – 10%
Rated Life: 50,000 hours

- Multiple LED array eliminates socket shadows
- Four finishes to complement most bath hardware
- No driver or transformer needed
- Dim with electronic low voltage (ELV) dimmer
- ETL damp location listed
- 277V available (special order)

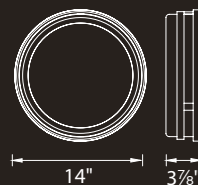

		Voltage	Watt	LED Lumens	Delivered Lumens	Finish
	FM-4313	120V	30W	2893	1750	BN Brushed Nickel
						CH Chrome

Example: **FM-4313-BN**
 For 277V, add an "F" before the finish: **FM-4313F-BN**

Astoria | Ceiling NEW



CEILING | **dweLED™**

Color Temp: 2700K
CRI: 85
Dimming: 100% – 10%
Rated Life: 50,000 hours

- Multiple LED array eliminates socket shadows
- Four finishes to complement most bath hardware
- ETL damp location listed
- No driver or transformer needed
- Dim with electronic low voltage (ELV) dimmer
- ETL damp location listed
- 277V available (special order)

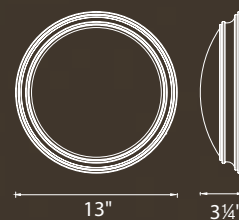

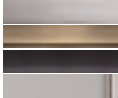
		Voltage	Watt	LED Lumens	Delivered Lumens	Finish
	FM-7013	120V	30.5W	2420	1230	AN <i>Antique Nickel</i>
						BB <i>Burnished Brass</i>
						BO <i>Brushed Bronze</i>
						PN <i>Polished Nickel</i>
						

Example: **FM-7013-AN**
 For 277V, add an "F" before the finish: **FM-7013F-AN**

Bristol | Ceiling NEW

CEILING | **dweLED™**



Color Temp: 2700K
CRI: 85
Dimming: 100% – 10%
Rated Life: 50,000 hours

- Multiple LED array eliminates socket shadows
- Dim with electronic low voltage (ELV) dimmer
- No driver or transformer needed
- ETL damp location listed
- 277V available (special order)

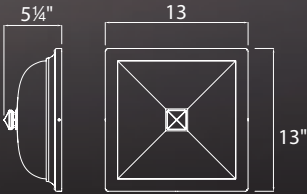

		Watt	LED Lumens	Delivered Lumens	Finish
	FM-7113	30W	2893	1090	AN <i>Antique Nickel</i>
					BB <i>Burnished Brass</i>
					BO <i>Brushed Bronze</i>
					PN <i>Polished Nickel</i>

Example: **FM-7113-BO**
 For 277V, add an "F" before the finish: **FM-7113F-BO**

Geos I Ceiling NEW



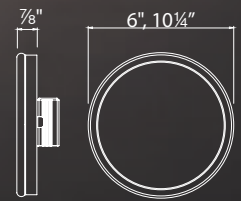

Color Temp: 2700K
CRI: 85
Dimming: 100% – 10%
Rated Life: 50,000 hours

- Super thin, edge-lit LED panel
- Die-case aluminum construction
- Wall or ceiling mount
- ADA compliant
- ETL damp location listed
- Dim with electronic low voltage (ELV) dimmer



CEILING | dwelLED™

				Watt	LED Lumens	Delivered Lumens	Finish
	<i>Small</i>	6"	FM-4606	7W	608	255	TT Titanium WT White
	<i>Large</i>	10"	FM-4610	11.5W	1064	525	

Example: **FM-4610-WT**

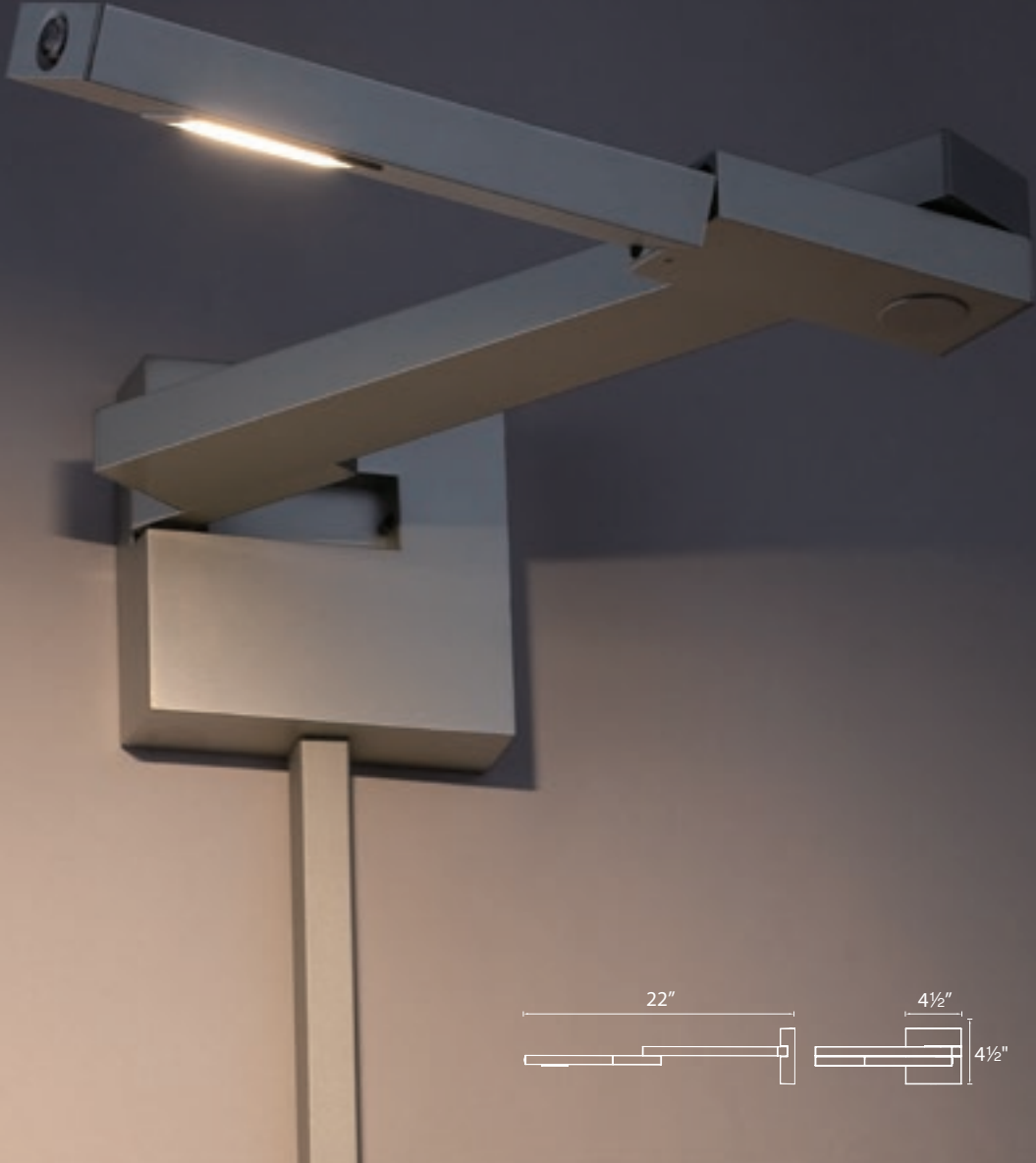

Flip | Swing Arm **NEW**



Color Temp: 3000K
 CRI: 85
 Dimming: 100% – 10%
 Rated Life: 50,000 hours

- Aluminum construction
- Two 12 inch cord covers included
- ETL damp location listed
- Integral touch dimmer
- Integral transformer



			Watt	LED Lumens	Delivered Lumens	Finish
	Left	BL-1021L	8.5 W	489	315	BZ Bronze TT Titanium
	Right	BL-1021R	8.5 W	489	315	

Example: **BL-1021R-BZ**

Hemmingway I Swing Arm NEW



Color Temp: 3000K
CRI: 85
Dimming: 100% – 10%
Rated Life: 50,000 hours

- Smooth tight swing arm operation
- Two 12 inch cord covers included
- ETL damp location listed
- Integral touch dimmer
- Integral transformer

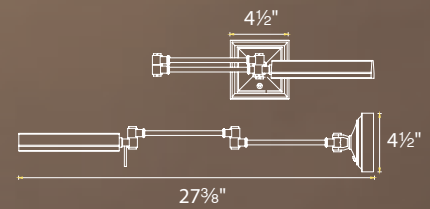

SWING ARM | **dweLED™**

		Watt	LED Lumens	Delivered Lumens	Finish
	BL-1527	6.5 W	445	325	AN <i>Antique Nickel</i> BB <i>Burnished Brass</i> RB <i>Rubbed Bronze</i> PN <i>Polished Nickel</i>

Example: **BL-1527-BB**

Stretch | Swing Arm **NEW**

SWING ARM | **dweILED™**



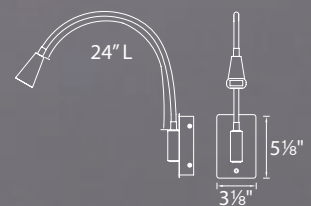

Color Temp: 3000K
CRI: 85
Dimming: 100% – 10%
Rated Life: 50,000 hours

- Flexible, yet fixable rubber tube for directing light
- Two 12 inch cord covers included
- ETL damp location listed
- Integral touch dimmer
- Integral transformer
- Conversion plate for 4" J box included





		Watt	LED Lumens	Delivered Lumens	Finish
	BL-1630	9 W	489	385	BK <i>Black</i> WT <i>White</i> 

Example: **BL-1630-WT**

Infiniti | Outdoor NEW

OUTODDR | **dwelLED™**



Color Temp: 3000K
CRI: 85
Dimming: 100% – 10%
Rated Life: 50,000 hours

- Exterior edge lit sconce luminaire
- Die cast aluminum construction
- Powder coat finishes
- Integral transformer
- ETL wet location listed
- ADA compliant (interior / exterior)
- Dim with electronic low voltage (ELV) dimmer
- 277V available (special order)

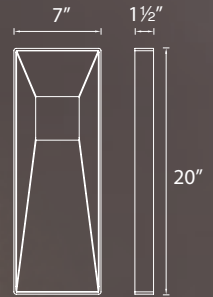

	Watt	LED Lumens	Delivered Lumens	Finish	
	WS-W5720	20.5W	1034	745	BZ <i>Bronze</i>
					GH <i>Graphite</i>
					WT <i>White</i>

Example: **WS-W5720-WT**
 For 277V, add an "F" before the finish: **WS-W5720F-WT**

Uno | Outdoor **NEW**



Color Temp: 3000K
CRI: 85
Dimming: 100% – 10%
Rated Life: 50,000 hours

- May be mounted up or down
- Aluminum construction
- Powder coat finishes
- No driver or transformer needed
- ETL wet location listed
- ADA compliant (interior / exterior)
- Dim with electronic low voltage (ELV) dimmer
- 277V available (special order)

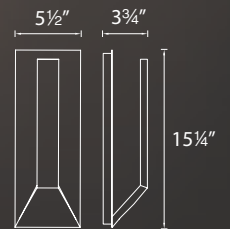

OUTDOOR | **dweLED™**

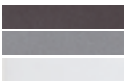
		Watt	LED Lumens	Delivered Lumens	Finish
	WS-W5915	15.5W	1234	875	BZ Bronze GH Graphite WT White 

Example: **WS-W5915-WT**
 For 277V, add an "F" before the finish: **WS-W5915F-WT**

Tao I Outdoor **NEW**



OUTODDR | **dwelLED™**

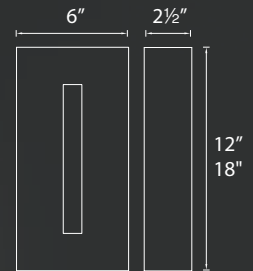

Color Temp: 3000K
CRI: 85
Dimming: 100% – 10%
Rated Life: 50,000 hours

- ETL wet location listed
- ADA compliant
- Patterned glass insert adds visual interest
- Sturdy gravity cast aluminum construction
- Powder coat finish
- Dim with electronic low voltage (ELV) dimmer
- 277V available (special order)



		Length		Watt	LED Lumens	Delivered Lumens	Finish
	<i>Small</i>	12"	WS-W5312	11W	830	220	BZ Bronze GH Graphite 
	<i>Large</i>	18"	WS-W5318	15W	1218	250	

Example: **WS-W5318-GH**
 For 277V, add an "F" before the finish: **WS-W5318F-GH**

Janus | Outdoor **NEW**



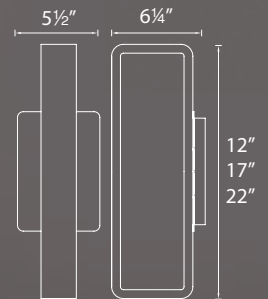

Color Temp: 3000K
CRI: 85
Dimming: 100% – 10%
Rated Life: 50,000 hours

- ETL wet location listed
- May be mounted vertical or horizontal
- Aluminum construction
- Powder coat finishes
- No driver or transformer needed
- Dim with electronic low voltage (ELV) dimmer
- 277V available (special order)



OUTDOOR | **dweLED™**

		Length		Watt	LED Lumens	Delivered Lumens	Finish
	<i>Small</i>	12"	WS-W5812	15W	1234	340	BZ Bronze GH Graphite WT White
	<i>Medium</i>	17"	WS-W5817	19W	1615	605	
	<i>Large</i>	22"	WS-W5822	30W	2468	960	

Example: **WS-W5812-GH**

For 277V, add an "F" before the finish: **WS-W5812F-GH**

Rubix | Outdoor NEW



OUTDOOR | **dwelLED™**

Color Temp: 3000K
 CRI: 85
 Dimming: 100% – 10%
 Rated Life: 50,000 hours

- Die-cast aluminum construction
- Powder coat finishes
- ETL wet location listed
- Dim with electronic low voltage (ELV) dimmer
- Universal river (120V-220V-277V)

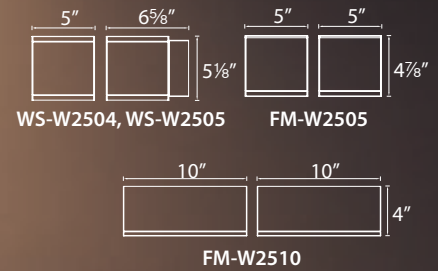

		Distribution		Voltage	Watt	LED Lumens	Delivered Lumens	Finish
	Wall Mount	Down	WS-W2504	120V - 277V	17W	1235	980	AL Brushed Aluminum BK Black BZ Bronze GH Graphite WT White
	Wall Mount	Up & Down	WS-W2505	120V - 277V	33.5W	2476	1839	
	Ceiling Mount	Down	FM-W2505	120V - 277V	17W	1235	980	
	Wall and Ceiling Mount	Down	FM-W2510	120V - 277V	32.5W	2470	2365	

Example: **FM-W2510-GH**

Tube | Outdoor **NEW**



Color Temp: 3000K
 CRI: 85
 Dimming: 100% – 10%
 Rated Life: 50,000 hours

- Die-cast aluminum construction
- Powder coat finishes
- ETL wet location listed
- Dim with electronic low voltage (ELV) dimmer

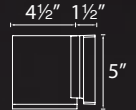

WS-W2605

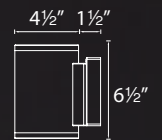

WS-W2604

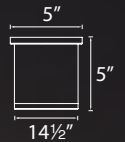



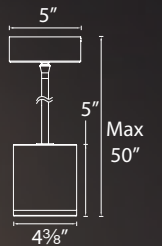

FM-W2605



PD-W2605

OUTDOOR | **dweLED™**

		Distribution		Voltage	Watt	LED Lumens	Delivered Lumens	Finish
	Wall Mount	Down	WS-W2605	120V	18W	1235	1145	AL Brushed Aluminum BK Black BZ Bronze GH Graphite WT White
	Wall Mount	Up & Down	WS-W2604	120V - 277V	32W	2470	2195	
	Ceiling Mount	Down	FM-W2605	120V	18W	1235	1060	
	Pendant	Down	PD-W2605	120V	18W	1235	1060	

Example: **PD-W2605-BK**

Tube Architectural | Ceiling Mount NEW

High Performance Outdoor Luminaires in 5", 6" and 8"



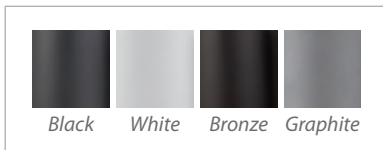

- Lumens:** Up to 4015
- CBCP:** Up to 28660
- CRI:** 85
- Dimming:** 100% – 10%
- Rated Life:** 80,000 hours

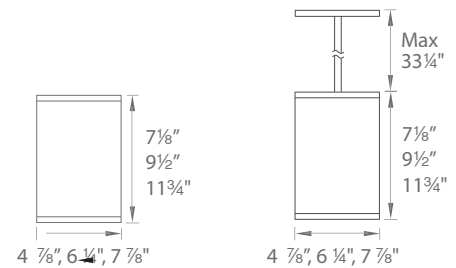

- IP65, Wet location listed
- Energy Star® rated
- ETL & cETL listed
- Aluminum construction
- Free of projected heat and UV radiation
- ANSI Compliant Warm/Neutral LED Bins, for the finest color consistency possible



		Diameter		Watt	Beam	Color Temp		Finish	
	Flush Mount DS-CD	05	5"	25 W	S Spot N Narrow F Flood	27 2700K 30 3000K 35 3500K	BK Black WT White BZ Bronze GH Graphite		
		06	6"	43 W					
		08	8"	55 W					
	Pendant Mount DS-PD								

Example: **DS-CD05-S27-BZ**

Tube Architectural | Wall Mount NEW

Specify Light Distributions



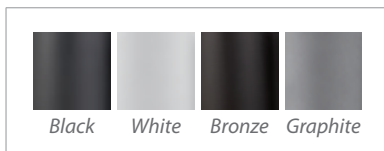

	<i>Single Sided</i>	<i>Double Sided</i>
Lumens:	<i>Up to 3685</i>	<i>Up to 3685 x2</i>
CRI:	85	85
Dimming:	100% – 10%	100% – 10%
Rated Life:	80,000 hours	80,000 hours

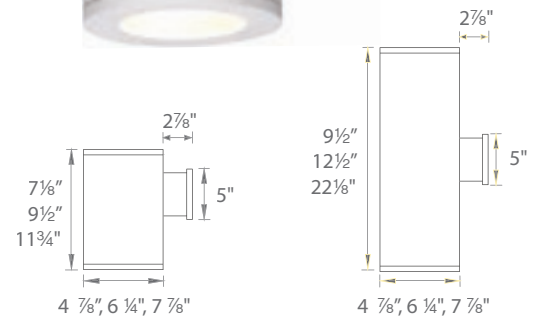

- IP65, Wet location listed
- Energy Star® rated
- ETL & cETL listed
- Aluminum construction
- Free of projected heat and UV radiation
- ANSI Compliant Warm/Neutral LED Bins, for the finest color consistency possible



		Diameter	Watt	Color Temp	Light Direction	Finish
 <i>Single Sided</i> (Dark sky friendly)	DS-WS	05F 5"	25 W	27 2700K	S <i>Straight up or down</i>	BK <i>Black</i> WT <i>White</i> BZ <i>Bronze</i> GH <i>Graphite</i>
		06F 6"	43 W	30 3000K	A <i>Away from the wall</i>	
		08F 8"	55 W	35 3500K	B <i>Towards the wall</i>	
					S <i>Straight up and down</i>	
 <i>Double Sided</i>	DS-WD	05F 5"	25 W	27 2700K	A <i>Away from the wall</i>	BK <i>Black</i> WT <i>White</i> BZ <i>Bronze</i> GH <i>Graphite</i>
		06F 6"	43 W	30 3000K	B <i>Towards the wall</i>	
		08F 8"	55 W	35 3500K	C <i>One side each</i>	
					S <i>Straight up and down</i>	

Example: **DS-WS06F-F30B-BK**

Vibe LED Picture Lights NEW

Color Temp: 2700K
CRI: 85
Dimming: 100% – 10%
Rated Life: 50,000 hours

- Full spectrum light for proper illumination of artwork
- Free of projected heat and UV and IR radiation
- Head rotates 35° up or down and extends out 14¾" from mounting surface
- 110° beam angle
- Replaceable LED module
- For portable models, 8 foot cord & plug with 18" wire cover in matching finish included

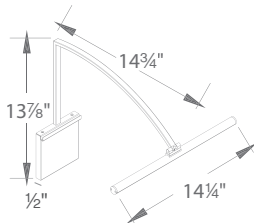
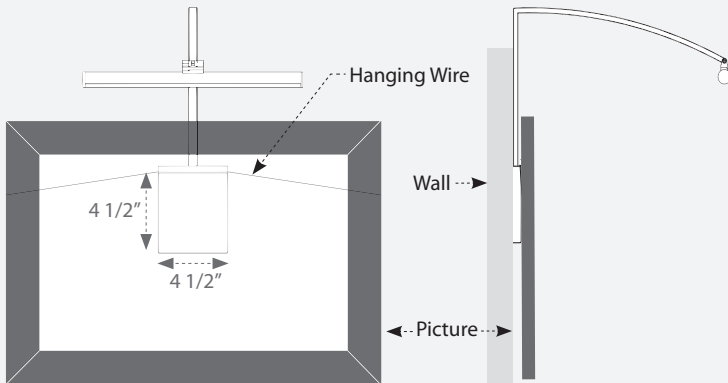

Model	Length	Watt	Lm	Finish
PL-LED15-27 <i>Hard Wired</i>	15"	8.5W	240	BK <i>Black</i>
PL-LED15P-27 <i>Portable*</i>				BN <i>Brushed Nickel</i>
				CH <i>Chrome</i>
				SB <i>Satin Brass</i>

Example: **PL-LED15P-27-BK**

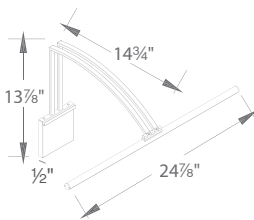

Model	Length	Watt	Lm	Finish
PL-LED25-27 <i>Hard Wired</i>	25"	16W	535	BK <i>Black</i>
PL-LED25P-27 <i>Portable*</i>				BN <i>Brushed Nickel</i>
				CH <i>Chrome</i>
				SB <i>Satin Brass</i>

Example: **PL-LED25-27-CH**

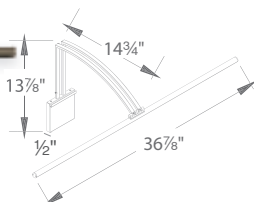

Model	Length	Watt	Lm	Finish
PL-LED37-27 <i>Hard Wired</i>	37"	23W	850	BK <i>Black</i>
PL-LED37P-27 <i>Portable*</i>				BN <i>Brushed Nickel</i>
				CH <i>Chrome</i>
				SB <i>Satin Brass</i>

Example: **PL-LED37P-27-BN**

*8 foot cord & plug with wire cover in matching finish included.

Hemmingway LED Picture Lights



Color Temp: 2700K
CRI: 85
Dimming: 100% – 10%
Rated Life: 50,000 hours

- Full spectrum light for proper illumination of artwork
- Free of projected heat and UV and IR radiation
- Head rotates 90° up or down and extends out 14³/₄" from mounting surface
- Replaceable LED module
- For portable models, 8 foot cord & plug with 18" wire cover in matching finish included

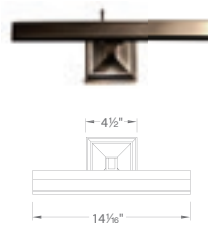

Model	Length	Watt	Lm	Finish
PL-LED14-27 <i>Hard Wired</i>	14"	9.4W	302	AN <i>Antique Nickel</i>
PL-LED14P-27 <i>Portable*</i>				BB <i>Burnished Brass</i>
				RB <i>Rubbed Bronze</i>
				PN <i>Polished Nickel</i>

Example: **PL-LED14P-27-RB**



Model	Length	Watt	Lm	Finish
PL-LED24-27 <i>Hard Wired</i>	24"	16.9W	535	AN <i>Antique Nickel</i>
PL-LED24P-27 <i>Portable*</i>				BB <i>Burnished Brass</i>
				RB <i>Rubbed Bronze</i>
				PN <i>Polished Nickel</i>

Example: **PL-LED24P-27-PN**

*8 foot cord & plug with wire cover in matching finish included.

WAC LIGHTING
Responsible Lighting®

wacighting.com
1-800-526-2588