

Ballast

Navigator

Table of Contents

Fluorescent Electronic Ballasts Section 1- Page

Product Overview	1-2
Application Operation Information	1-4
Typical Specifications.....	1-7
F17T8	1-13
F25T8	1-15
F32T8 (32, 30, 25 & 28 Watt Four Foot Lamps)	1-19
F28T8 (32, 30, 25 & 28 Watt Four Foot Lamps)	1-29
F40T8	1-32
F96T8 Slimline	1-34
F96T8HO High Output.....	1-35
T5	1-36
T5HO.....	1-38
T12	1-42
T12 Slimline.....	1-44
T12HO High Output	1-46
T2	1-47

Energy Management Systems Section 2- Page

--DCL With DEMANDflex

Product Overview	2-2
DEMANDflex T8	2-3
DEMANDflex T5, T5HO & TT5	2-6
DEMANDflex T8 Wiring Diagrams	2-7
DCL Controls	2-8

Controllable Lighting Section 2- Page

--Fluorescent Energy Management/Dimming Ballasts and Controls

Product Overview	2-10
-- BallaSTAR Light Level Switching	2-10
-- SuperDim Analog Dimming	2-11
-- DaliPRO Digital Dimming	2-12
-- VariPRO Parallel-Lamp Dimming	2-13
-- LevelPRO Parallel-Lamp Dimming	2-13
Application Operation Information	2-14
Controls for Analog Dimming Ballasts	2-15
DaliPRO	2-16
DaliPRO Premium	2-17
SuperDim	2-18
BallaSTAR 0-10 Volt	2-19
BallaSTAR Light Level Switching	2-20
Dimensions & Wiring Diagrams.....	2-22
VariPRO	2-23
LevelPRO	2-26

Table of Contents

Compact Fluorescent Ballasts Section 3- Page

Product Overview	3-2
Understanding Compact Fluorescent Technology	3-3
Configurations	3-4
Lamp Matrix	3-5
Typical Specifications.....	3-6
Nomenclature	3-7
13-26 Watt Twin, Quad and Triple.....	3-9
32 to 70 Watt Triple and Multiple	3-10
2D	3-12
T5 Circular	3-15
Long Twin T5	3-16

High Intensity Discharge (HID) Ballasts Section 4- Page

Product Overview	4-2
Oil Filled Capacitors	4-4
Dry Capacitors	4-5
Bracket Reference Chart.....	4-6
Application and Operation Information.....	4-7
Nomenclature	4-10
Typical Specifications.....	4-11
Distributor Replacement Kits	4-12
Core and Coil	
Metal Halide	4-16
Pulse Start Metal Halide	4-20
High Pressure Sodium.....	4-27
50 Hz Core and Coil Ballasts	4-33
F-Can Ballast.....	4-37
Ignitors.....	4-38
Reference Drawings.....	4-40

Electronic High Intensity Discharge (eHID) Ballasts Section 5- Page

Product Overview	5-2
Product Family Chart.....	5-3
Wiring Diagrams.....	5-4
Dimensions.....	5-5
Application and Operation Information.....	5-8

Lampholders Section 6- Page

Application and Operation Information.....	6-2
T8 & T12.....	6-5
T5	6-9
HID.....	6-11
Halogen.....	6-15
CFL.....	6-19

Sign Ballasts Section 7- Page

Application and Operation Information.....	7-2
Sign Ballast Footage Chart & Lead Lengths	7-3
Electronic Sign Ballasts	7-4

Table of Contents

Glossary	Section 8- Page
.....	8-1
Index	Section 9- Page
.....	9-1
Warranty	Section 10-Page
.....	10-1

Electronic Fluorescent Ballasts

A Complete Range of Solutions — From The Name You Trust

For more than 30 years, the lighting industry has relied on our TRIAD® brand for the most specified, most installed, most reliable electronic ballasts in the business.

The TRIAD® line offers advantages like installer-friendly universal input voltage, which ensures that you have the right voltage ballast every time, and maximum energy savings for long cycle operations.

And our ULTim8® and AccuStart™ ballasts feature high efficiency designs and programmed start technology that dramatically enhances lamp life.



Universal is the leader in energy saving electronic ballasts.

Product Overview

Setting The Pace In T8 Technology

Universal Lighting keeps pushing the frontier of T8 technology with innovative products that deliver dramatic energy savings, greater fixture design flexibility, longer lamp life and installation ease. You can count on Universal for some of the industry's highest efficiency and most hassle-free T8 ballasts.

Universal offers high efficiency T8 ballasts for Instant Start and Programmed Start applications. These ballasts deliver up to 6% additional energy savings over standard electronic ballasts, even more when used with the new F32T8/ES (25 Watt), F32T8/ES (30 Watt) or F28T8 (28 Watt) lamps. Our T8 ballasts are CEE and NEMA Premium compliant.

TRIAD® and ULTim8 Instant Start Applications

Instant Start technology for continuous operation and installer friendly Universal input voltage.

Maximizes energy savings for long cycle operations.

- Some of the most efficient ballasts in the industry for maximum energy savings.
- Available in high efficiency HE normal (.88), EL low (.77), and HEH high (1.18) ballast factor versions.
- Independent lamp operation simplifies troubleshooting. Lamps stay lit if one lamp fails preventing fixtures from going dark and replacing lamps unnecessarily.
- Lamp will auto-restrike as a standard feature allowing replacement of lamps without recycling power.
- Anti-striation control for better light quality when using energy saving lamps.
- Universal input voltage, installer friendly.
- Because these ballasts are CEE and NEMA Premium compliant they may qualify for utility incentives.
- Backed by 5 year warranty when operated at 75° C max case temperature.

ULTim8® Programmed Start Applications

Features true parallel lamp operation and fast start time (<700ms) so that if one lamp fails, other lamps stay lit. "Soft start" technology maintains lamp life, making these the perfect choice for high-cycling applications like occupancy sensors. Designed for use with 30, 28 and 25 Watt energy saving lamps for even more energy savings.

- Same benefits as Instant Start plus ...
- Available in high efficiency HE normal (.88) and EL low (.71), and HEH (1.18) ballast factor versions.
- Programmed Start ballasts are designed to quickly pre-heat lamp cathodes up to their optimum starting temperature and ignite the lamps quickly.
- Filament cut out on HE and HEH models for instant start level efficiency.
- The quick ignition results in long lamp life without the typical long delay during turn-on.
- Same 5 year warranty as instant start or 3-year warranty for HEH modules when operated at 90° C case temperature.

High Lumen and High Bay Applications

ULTim8® High Lumen ballasts are the high efficiency high ballast factor choice for high lumen T8 applications.

ULTim8® HB ballasts are designed to provide excellent performance in the high ambient temperature applications where high bay fluorescent fixtures are installed.

EL Ballasts: Used often when retrofitting existing T12 fixtures with T8 lamps to tune down lamp output.

Application areas include stairwells, hallways, bathrooms and other areas that are lit partially during the day. They are good for using in low light level areas. Change light levels with ballast factor.

HE Ballasts: Used often in new construction, the high efficiency version of our standard HP product. Used for frequently switched applications including occupancy sensors and daylight harvesting. They are a good solution for education, commercial offices and retail.

HEH Ballasts: Used to overdrive lamps. Use these for areas with high light output. They are a great solution for high bay fixtures including applications for warehouses and manufacturing.

Product Overview

T5 & T5HO Ballasts For Architectural and High Bay Applications

Whether it's for new construction or a retrofit project, Universal's T5 and T5HO ballasts, with their smaller size and high lumen output, have become the dominant player in architectural and high bay applications.

Programmed Start ballasts feature a "soft start" technology that maximizes lamp life, making them the perfect choice for high cycling applications including those involving occupancy sensors and wall switches.

High Efficiency (AccuStart5®, ULTim5®):

Our high efficiency T5 and T5HO ballasts are ideal for bathrooms, hallways, stairwells, gymnasiums, classrooms, libraries, corridors, offices, recessed volumetric strips, wraps, wall washing, displays, direct/indirect lighting, surface mount, cove, under cabinet or task lighting. Common applications include: commercial, retail, hospitality, restaurants, law offices, medical, institutional, airports, and schools.

The **AccuStart5®** and **ULTim5®** lines of linear fluorescent T5 and T5HO ballasts offer broad appeal to the most common applications. Universal input voltage (108-305 volts). T5 ballasts support (1) or (2) 2' F14T5, 3' F21T5, 4' F28T5, and 5' F35T5 full wattage and energy saving lamps. T5HO ballasts support (1) or (2) 2' F24T5HO 3' F39T5HO and (1) (2) (3) or (4) 4' F54T5HO full wattage and energy saving lamps.

High Bay (AccuStart5HB®):

T5HO High Bay ballasts are ideal for new construction and fixture retrofits in gymnasiums, high bay retail stores and warehouses, manufacturing sites, industrial facilities and similar applications. These High Output ballasts are well suited for applications where space is at a premium, including slim pendant mounted fixtures, cove and task lighting. AccuStart5HB ballasts offer a replacement opportunity for traditional HID high bay applications. Light up the aisles for the forklift operator when lighting is needed. Keep spaces lit when and where needed.

Universal offers the **AccuStart5HB®** line of linear fluorescent T5HO ballasts for High Bay applications. Ideal for extreme temperature (90° C Case Warranty). Universal input voltage (108-305 volts) and high range voltage (347-480 volts). These ballasts support (2) and (4) 117, 119, 120, 182, 184, 229 and 235 watt T5HO ballasts.

Canadian Voltage:

Universal offers Canadian voltage in 347V and high range voltage. These ballasts come in standard efficiency, high efficiency and High Bay for T5 and T5HO applications.



Family of Universal HP Ballasts.



Flexible Fixture design options for T5 and T5HO lamps.

Application And Operating Information

SAFETY

NEC & UL Requirements

Ballast installation presents the possibility of exposure to potentially hazardous voltages and should be performed only by qualified personnel. All installation, inspection and maintenance should be performed only with power to the fixture turned off. Additionally, all fixtures and ballasts must be installed and operated in compliance with the National Electrical Code, Underwriters Laboratories Inc. (UL) requirements, and all local applicable codes and regulations.

Polarity

Polarity refers to the proper connection of ballast lead wires to line wires. To aid you in a correct installation, Universal ballast leads are color-coded for easy identification. The WHITE ballast lead is to be connected to the neutral (grounded) and the BLACK (or black with white tracer) lead always to the phase (“hot”) line wire. Systems where neither of the line wires are at ground potential require specially designed ballasts. A change in polarity may result in the voltage from the lead to the ground exceeding UL-specified limits. In some types of ballasts, a change in polarity may decrease voltage from the lead to the ground, thereby impeding the starting dependability of the ballast.

Grounding

Ballast cases and fixtures must always be grounded. The ballast case may be grounded to the fixture or otherwise grounded. It could be hazardous to make contact with an ungrounded fixture or ballast when in operation. Neglecting to properly ground the ballast and fixture combination may also result in failure of certain lamps to start or for unacceptable levels of electromagnetic noise to be conducted onto the power lines.

Operating Line Voltage Limits

To receive the full benefits of rated lamp output and to prolong ballast life, it is essential that voltage supplied to an installation be maintained within limits prescribed for each circuit. These limits are listed below:

Nominal Voltage	VOLTAGE RANGE	
	Minimum	Maximum
120	108	132
220	198	242
277	249	305
347	312	382
120-277 (UNV)	108	305
347-480 (HRV)	312	528

Subjecting a ballast to excessive voltage for an extended period results in the deterioration of the insulation. This insulation breakdown will cause early ballast failure. Low voltage has no damaging effect on the ballast. However, lamps may not start reliably, and early lamp failure could result.

Internal Ballast Protection

Class P Classification - Since January 1, 1984, the National Electrical Code requires that “where Fluorescent fixtures are installed indoors, the ballast shall have thermal protection integral within the ballast except for simple reactance ballasts.” This ruling applies to replacement ballasts as well as to those contained within new fixtures.

In compliance with the National Electrical Code, UL has established a Class P ballast classification for fluorescent light fixtures.

A Class P ballast must employ internal thermal protection limiting its operating temperature.

Universal UL-approved Class P ballasts comply with the National Electrical Code requirement and are equipped with an automatic resetting thermal protector, built-in and adjacent to the transformer coils. The resetting thermal protector functions as a thermostat which will open and temporarily deactivate the ballast when it exceeds the permissible temperature. It will reset when the ballast cools to a safe operating temperature. The ballast will continue to cycle until the cause of overheating is eliminated. If the ballast is defective, it must be replaced. If the cause is external, a Class P ballast will resume normal operation after abnormal conditions are eliminated.

Application And Operating Information

SAFETY

Dimming Ballasts - Ballastar® Dimming Ballasts are controlled by using 10-0vDC. Care should be taken to insure that the line voltage (AC) wires are not connected to the low voltage DC wires. Ballastar® Electronic Dimming Ballasts have protection (safety) circuitry, that will sense the error so as not to harm the installer or the ballast. Dimming ballasts manufactured after May 1999 have the protection circuit. Dimming ballasts manufactured before this date do not have low voltage circuit protection.

Fusing - Class P ballasts do not require fusing. Fusing can be used when a single circuit has a large number of fixtures/ballasts. For a comprehensive list of appropriate fuses, contact our Technical Engineering Services (TES) Department at 1-800-BALLAST or check out our TES home page at www.unvlt.com.

Grounding - ANSI C82.1 recommends all fixtures and ballasts be grounded. Universal requires all electronic ballasts be grounded.

Thermal Protection - All Universal electronic ballasts meet UL 935 Standard for thermal protection. These ballasts are designated Class P. A Class P ballast will disconnect the ballast from input power in the event of internal over-temperature.

PERFORMANCE

Lamp Connections

Fluorescent ballasts are designed to generate voltages in excess of 300 volts. It is imperative that proper connection to quality Lampholders be assured in accordance with wiring diagrams on each page of the catalog and on product labels. Some applications may not require the use of all of the ballast output leads. If any leads are not to be connected, each should be individually capped and insulated to at least 600 volts.

Application Versatility

Many Universal models are designed to allow for applications with different types or quantities of lamps. Lamp applications not listed on label cannot be warranted.

Audible Noise (Sound)

Electrical equipment, including most fluorescent lamp ballasts, produces some noise. Care must be taken to select a ballast with the proper sound rating for a particular lighting installation. Secure mounting can reduce the potential for audible noise.

EMI/RFI

Electronic ballasts operate at high frequency and, therefore, may produce radio frequency interference (RFI) or electromagnetic interference (EMI). Some sensitive electrical equipment such as televisions, radios, or some medical equipment can be adversely affected by this RFI or EMI interference. Currently the electronic frequencies from 450 kilohertz (kHz) to 300 megahertz (MHz) are regulated by the FCC. For electronic ballasts, the limits and regulations are listed in the Code of Federal Regulations, Title 47, Part 18, Subpart C titled RF Lighting Devices. ULT provides ballasts compliant with non-consumer limits for commercial applications, as well as several models in compliance with consumer limits for residential use.

See the Data Sheets for the electronic ballast of interest to determine which FCC requirement, consumer or non-consumer the particular product meets.

Remote Mounting

Excessive hot or cold temperatures, audible noise requirements, or a desire to operate lamps in more than one fixture with the same ballast (tandem), may make it desirable to mount the ballast remotely. Care must be taken to allow for ballast heat dissipation and proper grounding.

In any application, the wire used to extend leads must be at least as large as the wire supplied on the ballast (18 AWG) with an insulation rating of 1000 VAC at 90°C.

Lead lengths in excess of those noted cause loading effects that can dramatically impact ballast performance and void the warranty.

See individual data sheets to determine all wiring options.

Application And Operating Information

PERFORMANCE

- **Lamp Starting Dependability**

Fluorescent lamps are inherently more difficult to start at low temperatures. All ballasts have limitations as to their ability to start lamps at low ambient temperatures. In this catalog, the low starting point for each lamp/ballast combination appears in the column marked "Minimum Starting Temperature."

Universal four lamp instant start ballasts can operate at a minimum starting temperature down to -18°C (0°F) under the following conditions:

1. Lead lengths to the lamps are those supplied, by Universal, with the ballast or shorter.
2. The distance from the lamp to the ground plane is no greater than $3/4"$.
3. The line voltage supplied to the ballast is no less than rated nominal.
4. The ballast or lamps are not remotely mounted.
5. The lamps have been burned in per lamp manufacturer requirements (typically 100 hours).

The lamp manufacturer should be contacted for lamp operating characteristics and requirements below 15°C (50°F).

- **Light Output**

Optimum light output from fluorescent lamps is achieved when the lamp wall is at $100-110^{\circ}\text{F}$. Any substantial excursion (either colder or warmer) will result in a reduction in light output.

- **Ballast Life**

A fluorescent lamp ballast, like any other electrical device, generates heat during its normal operation. Ballast temperatures should be kept as low as possible. Maximum dissipation of heat through fixture design and proper ballast installation will help. Although excessive temperature may not cause the ballast to fail immediately, it can shorten ballast life. To assure maximum life, the ballast case temperature should not exceed 75°C , in a maximum ambient (fixture cavity) of 40°C .

Causes of ballast overheating:

- Incorrect line voltage or frequency
- Incorrect size, type or number of lamps
- Incorrect wiring
- Poor heat dissipation due to surrounding insulation
- Sealed (Vapor Tight) Fixtures - Unusual heat build-up due to lack of ventilation in fixtures may cause thermal (on/off) cycling of certain ballasts. Consult Universal for specific recommendations.

RECOMMENDATIONS...

- Selection of a proper ballast to match the requirements of the lamp, fixture, voltage and installation.
 - Mounting of ballast within the fixture with as much surface contact as possible between the ballast and metal portions of the fixture. Secure mounting will aid in proper heat dissipation and can minimize the potential for ballast hum.
 - The use of heat-conducting dissipators (radiators), if necessary, which increase surface contact between the ballast and fixture.
 - If necessary, locate the ballast in a remote, cooler area outside the fixture.
 - Consult Universal for remote mounting recommendations.
- **Starting Method Legend**
 - IS = Instant Start
 - PS = Programmed Start
 - RS = Rapid Start
 - PAR-IS = Parallel Instant Start
 - PAR-PS = Parallel Programmed Start
 - PAR-RS = Parallel Rapid Start
 - SER-RS = Series Rapid Start

Specifications

TYPICAL SPECIFICATIONS FOR T8 INSTANT START BALLASTS:

- HP (High Performance Normal Ballast Factor)
 - EL (High Efficiency Low Ballast Factor)
 - HE (High Efficiency Normal Ballast Factor)
 - HEH (High Efficiency High Ballast Factor)
-
- Ballasts shall include 18AWG solid copper leads color coded in compliance with ANSI C82.11-2011.
 - Ballasts shall be instant start and provide starting sequence consistent with ANSI standard C82.11-2011.
 - Ballasts (1-4 lamps) shall operate as Parallel Circuit, allowing remaining lamp(s) to maintain full light output if one or more lamps fail.
 - Ballasts shall operate from 50/60 Hz input source of 120 through 277 Volts, and sustained variations of $\pm 10\%$ (Voltage & Frequency) with no damage to the ballasts.
 - Ballasts shall be a high frequency electronic type, and operate lamps at a frequency above 42 kHz to minimize interference with infrared control systems.
 - Ballasts shall tolerate operation in ambient temperatures up to 105°F (40°C) without damage.
 - Ballasts shall have a minimum starting temperature of 0°F (-18°C) for the primary lamp application.
 - Ballasts shall have a maximum case temperature test point of 75°C printed on the label for easy fixture testing and trouble shooting.
 - Ballasts shall support 18' maximum lead length remote mounting for the primary lamp.
 - Ballasts shall comply with FCC Part 18 Non-Consumer Equipment for EMI (power line conducted) and RFI (Radiated).
 - Ballasts shall provide transient immunity as recommended by ANSI C82.11-2011.
 - Ballasts shall auto-restrike allowing replacement of lamps without cycling power.
 - Ballasts shall incorporate Anti-Striation Circuitry for stable operation of reduced wattage lamps.
 - Ballasts shall operate lamps with no visible flicker (<3% flicker index).
 - Ballasts shall tolerate sustained open circuit and short circuit output conditions without damage.
 - Ballasts shall be Underwriters Laboratory (UL 935) listed, Class P, Type 1 Outdoor and/or CSA certified for both US and Canadian application.
 - Ballasts shall meet NEMA Premium/CEE High Performance for high efficiency operation.
 - Ballasts shall be quiet Class A sound rating.
 - Ballasts shall have a Ballast Factor for the primary lamp application of greater than .77 for EL, .85 for HE and 1.15 for HEH, per ANSI C82.11-2011.
 - Input current Total Harmonic Distortion shall not exceed 10% for the primary lamp.
 - Ballasts shall have a Power Factor greater than .98 for primary lamp.
 - Lamp Current Crest Factor (ratio of peak to RMS current) shall be 1.7 or less in accordance with lamp manufacturer recommendation and ANSI C82.11-2011.
 - The ballasts shall not have any PCB's.
 - The manufacturer shall provide written warranty against defects in material or workmanship, including replacement, for five years from date of manufacture.
 - Manufacturer shall have been manufacturing electronic ballasts for at least thirty years.
 - Ballasts shall be manufactured in an ISO 9001/ISO 9002 certified facility in North America.
 - Ballasts shall be Universal Lighting Technologies Bx32IUNVHP-N (x=1 or 2) or Bx32IUNVHP-A (x= 3 or 4) depending upon the quantity of lamps per fixture.

Specifications

TYPICAL SPECIFICATIONS FOR T8 PROGRAMMED START BALLASTS:

- EL (High Efficiency Low Ballast Factor)
 - HE (High Efficiency Normal Ballast Factor)
 - HEH (High Efficiency High Ballast Factor)
-
- Ballasts shall include 18AWG solid copper leads color coded in compliance with ANSI C82.11-2011.
 - Ballasts shall be Programmed Start with arc current established in less than 700 milliseconds after power is applied.
 - Ballasts (2-4 lamps) shall operate as a Parallel Circuit, allowing remaining lamp(s) to maintain full light output if one or more lamps fail.
 - Ballasts shall have a minimum Rh/Rc of 4.25 each time the lamps are started.
 - Ballasts shall have a maximum ionization current (Glow Current) of 10 milliamps during preheating interval.
 - Ballasts shall operate from a 50/60 Hz input source of 120 through 277 Volts, and sustained variations of $\pm 10\%$ (Voltage & Frequency) with no damage to the ballasts.
 - Ballasts shall be a high frequency electronic type, and operate lamps at a frequency above 42 kHz to minimize interference with infrared control systems.
 - EL and HE ballasts shall tolerate operation in ambient temperatures up to 105°F (40°C) without damage. In addition, HEH ballasts shall operate up to a 194°F (90°C) maximum case temperature.
 - Ballasts shall have a maximum case temperature test point printed on the label for easy fixture testing and trouble shooting.
 - Ballasts shall have a minimum starting temperature of -20°F (-29°C) for the primary lamp application when not remote mounted.
 - Ballasts shall support 20' maximum lead length remote mounting for the primary lamp.
 - Ballasts shall comply with FCC Part 18 Non-Consumer Equipment for EMI (power line conducted) and RFI (Radiated).
 - Ballasts shall provide transient immunity as recommended by ANSI C82.11-2011.
 - Ballasts shall auto-restrike allowing replacement of lamps without cycling power.
 - Ballasts shall incorporate Anti-Striation Circuitry for stable operation of reduced wattage lamps.
 - Ballasts shall operate lamps with no visible flicker (<3% flicker index).
 - Ballasts shall tolerate sustained open circuit and short circuit output conditions without damage.
 - Ballasts shall be Underwriters Laboratory (UL 935) listed, Class P, Type 1 Outdoor and/or CSA certified for both US and Canadian application.
 - Ballasts shall meet NEMA Premium/CEE High Performance for high efficiency operation.
 - Ballasts shall be quiet Class A sound rating.
 - Ballasts shall have a Ballast Factor for the primary lamp application of greater than .71 for EL, .88 for HE, and 1.15 for HEH, per ANSI C82.11-2011.
 - Input current Total Harmonic Distortion shall not exceed 10% for the primary lamp application.
 - Ballasts shall have a Power Factor greater than 0.98, for the primary lamp application.
 - Lamp Current Crest Factor (ratio of peak to RMS current) shall be 1.7 or less in accordance with lamp manufacturer recommendation and ANSI C82.11-2011.
 - The ballasts shall not have any PCB's.
 - The manufacturer shall provide written warranty against defects in material or workmanship, including replacement, for five years from date of manufacture. In addition, HEH models shall carry a three year warranty when operated at 194°F (90°C) maximum case temperature.
 - Manufacturer shall have been manufacturing electronic ballasts for at least thirty years.
 - Ballasts shall be manufactured in an ISO 9001/ISO 9002 Certified Facility in North America.
 - Ballasts shall be RoHS compliant.
 - Ballasts shall be Universal Lighting Technologies ULTim8 Programmed Start Product B232PUNVEL-B, B332PUNVEL-A, B432PUNVEL-A, B232PUNVHE-B, B332PUNVHE-A, B432PUNVHE-A, B232PUNVHEH-A, B332PUNVHEH-A, or B432PUNVHEH-E.

Specifications

TYPICAL SPECIFICATIONS FOR T5 & T5HO BALLASTS:

- Ballasts shall include 18AWG solid copper leads color coded in compliance with ANSI C82.11-2011 or shall use wire trap terminals for ease of installation.
- Ballasts shall be Programmed Start.
- Ballasts shall operate from a 50/60 Hz input source of 120 through 277 Volts, and sustained variations of $\pm 10\%$ (Voltage & Frequency) with no damage to the ballasts.
- Ballasts shall be a high frequency electronic type, and operate lamps at a frequency above 42 kHz to minimize interference with infrared control systems.
- Ballasts shall tolerate operation in ambient temperatures up to 105°F (40°C) without damage. HB ballasts shall operate up to 194°F (90°C) maximum case temperature.
- Ballasts shall have a minimum starting temperature of 0°F (-18°C) for the primary lamp application. T5HO ballasts shall have a minimum starting temperature of -20°F (-29°C) for the primary lamp application when not remote mounted.
- Ballasts shall support 20' lead length remote mounting for the primary lamp.
- Ballasts shall comply with FCC Part 18 Non-Consumer Equipment for EMI (power line conducted) and RFI (radiated).
- Ballasts shall provide transient immunity recommended by ANSI C82.11-2011.
- Ballasts shall incorporate lamp shutdown circuitry for end of lamp life protection.
- Ballasts shall auto-restrike to allow for re-lamping without the need to cycle power.
- Ballasts shall operate lamps with no visible flicker (<3% flicker index).
- Ballasts shall tolerate sustained open and short circuit output conditions without damage.
- Ballasts shall be Underwriters Laboratory (UL 935) listed, Class P, Type 1 Outdoor, and/or CSA certified for both US and Canadian application.
- Ballasts shall be quiet Class A sound rating.
- Ballasts shall have a Ballast Factor for the primary lamp application greater than .95 per ANSI C82.11-2011. Exceptions are ballasts that specify BF in part number, such as B228PUNV85-D, B228PUNV90-C and B228PUNV115-D.
- Input current Total Harmonic Distortion shall not exceed 10% for the primary lamp.
- Ballasts shall have a Power Factor greater than .98 for the primary lamp application.
- Lamp Current Crest Factor (ratio of peak to RMS current) shall be 1.7 or less in accordance with lamp manufacturer recommendation and ANSI C82.11-2011.
- The ballasts shall not have any PCB's.
- The manufacturer shall provide written warranty against defects in material or workmanship, including replacement, for five years from date of manufacture. In addition, HB ballasts shall carry a three year warranty at a maximum case temperature of 194°F (90°C).
- Manufacturer shall have been manufacturing electronic ballasts for at least thirty years.
- Ballasts shall be manufactured in an ISO 9001 / ISO 9002 Certified Facility in North America.
- Ballast shall be Universal Lighting Technologies Accustart5.

Specifications

TYPICAL SPECIFICATIONS FOR ELECTRONIC COMPACT FLUORESCENT BALLASTS:

- Ballasts shall be constructed of metal housing to meet plenum and construction code requirements while providing maximum heat transfer without extra grounding wires for extended ballast life.
- Ballasts shall be constructed using dual entry color coded wire trap terminals for wiring accuracy and ease of installation.
- Ballasts shall be Programmed Start.
- Ballasts shall have a minimum Rh/Rc of 4.25 each time the lamps are started.
- Ballasts shall have a maximum ionization current (Glow Current) of 25 milliamps during preheating interval.
- Ballasts shall operate from 50/60 Hz input source of 120 through 277 Volts, and sustained variations of $\pm 10\%$ (Voltage & Frequency) with no damage to the ballasts.
- Ballasts shall be a high frequency electronic type, and operate lamps at a frequency above 50 kHz to minimize interference with infrared control systems.
- Ballasts shall have a minimum starting temperature of 0°F (-18°C) for the primary lamp application.
- Ballasts shall tolerate operation in ambient temperatures up to 140°F (55°C) without damage.
- Ballasts shall have a maximum case temperature test point of 75°C printed on the label for easy fixture testing and trouble shooting.
- Ballasts shall support 12' lead length remote mounting for the primary lamp.
- Ballasts shall comply with FCC Part 18 Non-Consumer Equipment for EMI (power line conducted) and RFI (radiated).
- Ballasts shall provide transient immunity as recommended by ANSI C82.11-2011.
- Ballasts shall incorporate end of lamp life shutdown circuitry for end of lamp life protection.
- Ballasts shall allow for re-lamping without the need to cycle power.
- Ballasts shall operate lamps with no visible flicker (<3% flicker index).
- Ballasts shall tolerate sustained open and short circuit output conditions without damage.
- Ballasts shall be Underwriters Laboratory (UL 935) listed, Class P, Type 1 Outdoor and/or CSA certified for both US and Canadian application.
- Ballasts shall be UL 935 Type CC rated to reduce arcing caused by loose connections or improper lamp-pin to lampholder contact.
- Ballasts shall be UL 2043 certified for use in plenums and marked on label as "Suitable for Air Handling Spaces".
- Ballasts shall be quiet Class A sound rating.
- Ballasts shall have a Ballast Factor for primary lamp application greater than .95 per ANSI C82.11-2011.
- Input current Total Harmonic Distortion shall not exceed 10% for the primary lamp.
- Ballasts shall have a Power Factor greater than .98 for the primary lamp application.
- Lamp Current Crest Factor (ratio of peak to RMS current) shall be 1.7 or less in accordance with lamp manufacturer recommendation and ANSI C82.11-2011.
- The ballasts shall not have any PCB's.
- The manufacturer shall provide written warranty against defects in material or workmanship, including replacement, for five years from date of manufacture.
- Manufacturer shall have been manufacturing electronic ballasts for at least thirty years.
- Ballasts shall be manufactured in an ISO 9001 / ISO 9002 Certified Facility in North America.
- Ballasts shall be manufactured by Universal Lighting Technologies.

Notes

Electronic Ballast Applications

Remote Mounting

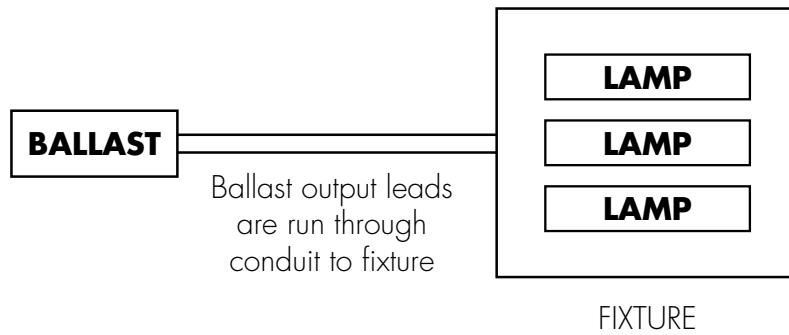

Configuration is applicable to 1, 2 and 4-lamp fixtures as well.

Through Wiring

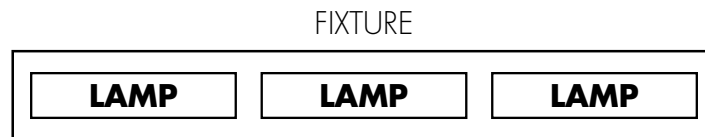

Ballast output leads are run through the fixture to each lamp, NOT through conduit. Minimize lead lengths by mounting ballast at the center of the fixture when possible.

Configuration is applicable to 2 and 3-lamp fixtures as well.

Tandem Wiring

2-Ballast Configuration

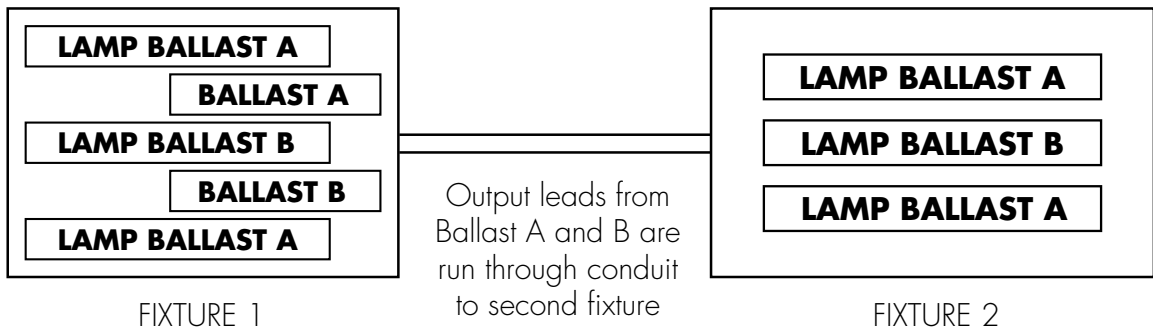

1-Ballast Configuration

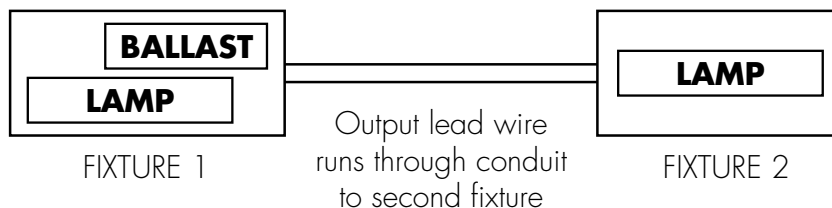

TRIAD® ELECTRONIC BALLASTS

FOR (1) & (2) F17T8 LAMP

- Low Profile Designs Featured
- Instant & Programmed Rapid Starting Options
- 1-2 Lamp Applications

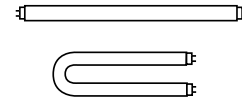

F17T8

Lamp		Line Volts	Catalog Number	Line Current (Amps)	Input Power (Watts)	Power Factor (PF)	Ballast Factor (BF)	Ballast Efficacy Factor (BEF)	THD %	Min. F/C Start Temp	Wiring Diag.	Dim.	
Qty.	Starting Method												
F11T8 - One Lamp Application													
1	IS	120	B132IUNVHE-N	0.09	11	> .99	0.90	8.18	< 10	0/-18	3a	-N	
		120	B232IUNVHP-N	0.12	14	> .99	0.90	6.43	< 10	0/-18	3a	-N	
F11T8 - Two Lamp Application													
2	PAR-IS	120	B232IUNVHP-N	0.17	20	> .99	0.78	3.90	< 10	0/-18	3	-N	
		277		0.08	21	> .96		3.71	< 15				
F15T8 - One Lamp Application													
1	IS	120	B132IUNVHE-N	0.11	14	> .99	0.90	6.43	< 10	0/-18	3a	-N	
		120	B232IUNVHP-N	0.14	16	> .99	1.02	6.38	< 10	0/-18	3a	-N	
F15T8 - Two Lamp Application													
2	PAR-IS	120	B232IUNVHP-N	0.21	25	> .99	0.86	3.51	< 10	0/-18	3	-N	
		277		0.09		> .98		3.50	< 10				
F17T8 - One Lamp Application													
1	IS	120	B232I120RES-A*	0.35	21	> .50	1.08	5.14	< 150	0/-18	3a	-A	
		120	B232I120RES-G*	0.34	22	> .50	1.08	4.91	< 150	0/-18	3a	-G	
		347	B132I347HP	0.05	18	> .95	0.92	5.11	< 15	0/-18	1	ST	
		120	B232IUNV-C	0.17	20	> .98	1.04	5.20	< 10	0/-18	21a	-C	
		277		0.08		> .95							
		120	B132IUNVEL-A ²	0.12	14	> .98	0.78	5.57	< 15	0/-18	1	-A	
		277		0.06		> .90							
		120	B132IUNVHE-N	0.14	16	> .98	0.90	5.63	< 10	0/-18	1	-N	
		277		0.06		> .97							
		120	B132IUNVHP-N	0.14	17	> .96	0.90	5.29	< 10	0/-18	1	-N	
		277		0.07	18			5.00	< 15				
		120	B232IUNVHP-N	0.17	21	> .99	1.07	5.10	< 10	0/-18	3a	-N	
		277		0.08		> .96							
		120	B132PUNVHP-A ²	0.15	17	> .99	0.91	5.35	< 10	0/-18	2	-A	
		277		0.07		> .96			< 15				
1	PS	120	B232PUNVHEH-A ¹	0.23	26	> .99	1.38	5.29	< 10	-20/-29	30	-A	
		277		0.11	27	> .94		5.17	< 10				
		347	ES1510A	0.05	18	> .97	0.87	4.83	< 10	0/-18	40	ESA	
F17T8 - Two Lamp Applications													
2	PAR-IS	120	B232I120RES-G*	0.49	33	> .50	0.94	2.85	< 140	0/-18	3	-G	
		120	B232I120RES-A*	0.49	32	> .50	0.94	2.94	< 140	0/-18	3	-A	
		347	B232I347HP-A	0.09	32	> .95	0.92	2.88	< 10	0/-18	3	-A	
		347	B232I347HPL	0.09	29	> .98	0.79	2.72	< 10	0/-18	3	ST	
		120	B232IUNV104-A	0.30	36	> .99	1.04	2.78	< 10	0/-18	3	-A	
		277		0.15		> .88							
		120	B232IUNV-C	0.27	31	> .98	0.91	2.94	< 10	0/-18	21	-C	
		277		0.12									
		120	B232IUNVEL-A ²	0.21	25	> .95	0.80	3.20	< 10	0/-18	3	-A	
		277		0.10	26			3.08	< 10				
		120	B232IUNVEL-N ²	TBD	TBD	TBD	TBD	TBD	TBD	TBD	TBD	TBD	TBD
		277		TBD	TBD	TBD	TBD	TBD	TBD	TBD	TBD	TBD	TBD
		120	B232IUNVHE-A ²	0.24	30	> .95	0.90	3.00	< 10	0/-18	3	-A	
		277		0.12									
		120	B232IUNVHP-N	0.26	31	> .99	0.89	2.87	< 10	0/-18	3	-N	
277		0.11		> .98									
120	B232IUNVHEH-A	0.33	41	> .95	1.18	2.88	< 10	-20/-29	3	-A			
277		0.15	40			2.95							

* For Residential Use Only

¹ Consult Lamp Manufacturers for applications with Ballast Factor > 1.20

² Consult Universal for Availability

See page 1-18 for Dimensions and Wiring Diagrams

STARTING METHOD LEGEND

IS = Instant Start

RS = Rapid Start

PAR-PS = Parallel Programmed Start

PAR-RS = Parallel Rapid Start

SER-IS = Series Instant Start

PS = Programmed Start

PAR-IS = Parallel Instant Start

SER-PS = Series Programmed Start

SER-RS = Series Rapid Start

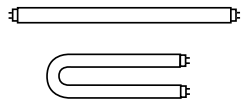

- Low Profile Designs Featured
- Instant & Programmed Rapid Starting Options
- 3-4 Lamp Applications

TRIAD® ELECTRONIC BALLASTS FOR (3) & (4) F17T8 LAMPS

Lamp		Line Volts	Catalog Number	Line Current (Amps)	Input Power (Watts)	Power Factor (PF)	Ballast Factor (BF)	Ballast Efficacy Factor (BEF)	THD %	Min. F/C Start Temp	Wiring Diag.	Dim.
Qty.	Starting Method											
F17T8 - Two Lamp Applications												
2	SER-PS	347	ES1329 A	0.11	36	> .97	0.87	2.42	< 10	0/-18	37	ESA
		120	B232PUNVEL-B	.22	26	> .99	0.74	2.80	< 10	-20/-29	30	-B
		277		.11	25	> .92		2.96				
		120	B232PUNVHE-B	.25	30	> .90	0.90	3.00	< 10	-20/-29	30	-B
		277		.12								
		120	B232PUNVHEH-A	.35	41	> .99	1.20	2.95	< 10	-20/-29	30	-A
2	PAR-PS	277		.16		> .97		2.93				
		120	B332PUNVHEH-A ¹	.38	46	> .98	1.31	2.85	< 10	-20/-29	30	-A
		277		.17								
		F17T8 - Three Lamp Applications										
		347	B332I347HP	0.14	48	> .98	0.92	1.92	< 10	0/-18	6	ST
		347	B332I347HPL	0.12	43	> .99	0.80	1.85	< 10	0/-18	6	ST
3	PAR-IS	120	B332IUNVEL-A	0.35	42	> .99	0.82	1.95	< 10	0/-18	6	-A
		277		0.15	41	> .95		2.00				
		120	B332IUNVHE-A	0.39	46	> .99	0.92	2.00	< 10	0/-18	6	-A
		277		0.17		> .97						
		120	B332IUNVHP-A	0.38	45	> .99	0.92	2.04	< 10	0/-18	6	-A
		277		0.18		> .90						
		120	B432I120RES-A*	0.72	51	> .50	1.00	1.96	< 135	0/-18	7a	-A
		120	B332PUNVEL-A	0.31	37	> .99	.74	1.99	< 10	-20/-29	49	-A
		277		0.14		> .94		2.01				
		120	B332PUNVHE-A	0.37	44	> .90	.91	2.05	< 10	-20/-29	49	-A
3	PAR-PS	277		0.16	43			2.14				
		120	B332PUNVHEH-A	0.49	59	> .98	1.19	2.02	< 10	-20/-29	49	-A
		277		0.22	58			2.04				
		120	B432PUNVHEH-E	0.47	56	> .99	1.14	2.04	< 10	-20/-29	49	-E
		277		0.23	58	> .91		1.97				
		F17T8 - Four Lamp Applications										
		120	B432I120RES-A*	0.84	61	> .50	0.92	1.51	< 130	0/-18	7a	-A
		347	B432I347HP	0.19	62	> .98	0.92	1.48	< 10	0/-18	7a	ST
		347	B432I347HPL	0.17	56	> .97	0.82	1.46	< 10	0/-18	7	ST
		120	B432IUNVEL-A	0.44	53	> .98	0.79	1.49	< 10	0/-18	7a	-A
4	PAR-IS	277		0.20	52	> .95		1.52				
		120	B432IUNVHE-A	0.49	59	> .98	0.90	1.53	< 10	0/-18	7a	-A
		277		0.22	58	> .95		1.55				
		120	B432IUNVHP-A	0.49	59	> .98	0.90	1.53	< 10	0/-18	7a	-A
		277		0.22	58	> .90		1.55				
		120	B432PUNVEL-A	0.42	50	> .99	0.72	1.43	< 10	-20/-29	50	-A
		277		0.18	49	> .95		1.47				
		120	B432PUNVHE-A	0.49	59	> .90	0.89	1.52	< 10	-20/-29	50	-A
4	PAR-PS	277		0.22	58			1.54				
		120	B432PUNVHEH-E	0.65	77	> .99	1.19	1.54	< 10	-20/-29	50	-E
		277		0.30	79	> .95	1.20	1.52				

* For Residential Use Only

¹ Consult Lamp Manufacturers for applications with Ballast Factor > 1.20

See page 1-18 for Dimensions and Wiring Diagrams

TRIAD® ELECTRONIC BALLASTS

FOR (1) & (2) F25T8 LAMP

- Standard & Low Profile Designs Featured
- Instant & Programmed Rapid Starting Options
- 1-2 Lamp Applications

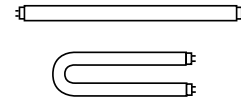

F17T8- F25T8

Lamp		Line Volts	Catalog Number	Line Current (Amps)	Input Power (Watts)	Power Factor (PF)	Ballast Factor (BF)	Ballast Efficacy Factor (BEF)	THD %	Min. F/C Start Temp	Wiring Diag.	Dim.	
Qty.	Starting Method												
F25T8 - One Lamp Applications													
1	IS	347	B132I347HP	0.07	25	> .95	0.90	3.60	< 10	0/-18	1	ST	
		120	B132IUNVEL-A	0.18	19	> .98	0.78	4.11	<10	0/-18	1	-A	
		277		0.09		> .90							
		120	B132IUNVHE-N	0.20	23	> .99	0.89	3.87	<10	0/-18	1	-N	
		277		0.09		> .98							
		120	B132IUNVHP-N	0.20	24	>.98	0.88	3.67	< 10	0/-18	1	-N	
		277		0.09									
		120	B232IUNVHP-N	0.24	28	> .99	1.05	3.75	< 10	0/-18	3a	-N	
		277		0.10		> .98							
		120	B232I120RES-A*	0.43	28	> .50	1.08	3.86	< 150	0/-18	3a	-A	
		120	B232I120RES-G*	0.43	28	> .50	1.08	3.86	< 150	0/-18	3a	-G	
		347	B232I347HPL	0.08	26	> .98	0.88	3.38	< 10	0/-18	3a	ST	
120	B232IUNV-C	0.24	28	> .98	1.02	3.64	< 10	0/-18	21a	-C			
277		0.11											
1	PS	347	ES1510A	0.07	24	> .97	0.87	3.63	< 10	0/-18	40	ESA	
		120	B232PUNVHEH-A ¹	0.31	37	>.99	1.36	3.70	< 10	-20/-29	30	-A	
		277		0.14		>.97		3.67					
		120	B132PUNVHP-A	0.20	24	> .99	0.91	3.79	< 10	0/-18	2	-A	
277		0.09		> .98									
F25T8 - Two Lamp Applications													
2	PAR-IS	120	B232I120RES-A*	0.64	46	> .50	0.92	2.00	< 130	0/-18	3	-A	
		120	B232I120RES-G*	0.64	46	> .50	0.92	2.00	< 140	0/-18	3	-G	
		347	B232I347HP-A	0.13	46	> .95	0.89	1.93	< 10	0/-18	3	-A	
		347	B232I347HPL	0.12	41	> .98	0.75	1.83	< 10	0/-18	3	ST	
		120	B232IUNV-C	0.37	45	> .98	0.90	2.00	< 10	0/-18	21	-C	
		277		0.16	44			2.05					
		120	B232IUNV104-A	0.43	51	> .99	1.04	1.94	< 10	0/-18	3	-A	
		277		0.20	50	> .93		1.98					
		120	B232IUNVEL-A ²	0.30	36	> .95	0.79	2.19	< 10	0/-18	3	-A	
		277		0.14	37		0.80	2.18					
		120	B232IUNVEL-N ²	TBD	TBD	TBD	TBD	TBD	TBD	TBD	TBD	TBD	TBD
		277		TBD	TBD								
		120	B232IUNVHE-A	0.36	44	> .95	0.88	2.00	< 10	0/-18	3	-A	
		277		0.16									
		120	B232IUNVHP-N	0.37	44	> .99	0.90	2.05	< 10	0/-18	3	-N	
		277		0.16	43			2.09					
120	B232IUNVHEH-A	0.51	61	> .95	1.18	1.93	< 10	20/-29	3	-A			
277		0.22	60			1.97							
2	SER-PS	347	ES1329A	0.14	49	> .97	0.87	1.78	<10	0/-18	37	ESA	
		120	B232PUNVEL-B	0.30	36	> .99	0.74	2.06	<10	-20/-29	30	-B	
277		0.14	35	> .96		2.12							
2	PAR-PS	120	B232PUNVHE-B	0.35	42	> .90	0.90	2.14	<10	-20/-29	30	-B	
		277		0.16	41			2.18					
		120	B232PUNVHEH-A	0.50	60	> .99	1.18	1.98	<10	-20/-29	30	-A	
		277		0.22	59	> .98		1.99					
120	B332PUNVHEH-A ¹	0.55	66	> .98	1.31	1.98	<10	-20/-29	30	-A			
277		0.24	65			2.00							

* For Residential Use Only

¹ Consult lamp manufacturer for applications with ballast factor >1.20

² Consult Universal for availability

See page 1-18 for Dimensions and Wiring Diagrams

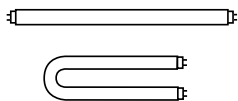

- Low Profile Designs Featured
- Instant & Programmed Rapid Starting Options
- 3 Lamp Applications

TRIAD® ELECTRONIC BALLASTS FOR (3) F25T8 LAMPS

Lamp		Line Volts	Catalog Number	Line Current (Amps)	Input Power (Watts)	Power Factor (PF)	Ballast Factor (BF)	Ballast Efficacy Factor (BEF)	THD %	Min. F/C Start Temp	Wiring Diag.	Dim.
Qty.	Starting Method											
F25T8 - Three Lamp Applications												
3	PAR-IS	120	B432I120RES-A*	0.96	71	> .50	0.98	1.38	< 130	0/-18	7a	-A
		347	B332I347HP	0.20	68	> .99	0.91	1.34	< 10	0/-18	6	ST
		347	B332I347HPL	0.17	60	> .99	0.76	1.26	< 10	0/-18	6	ST
		120	B332IUNVEL-A	0.49	59	> .99	0.80	1.36	< 10	0/-18	6	-A
		277	B332IUNVEL-A	0.22	58	> .97	0.80	1.38	< 10	0/-18	6	-A
		120	B332IUNVHE-A	0.56	67	> .99	0.90	1.34	< 10	0/-18	6	-A
		277	B332IUNVHE-A	0.24	66	> .98	0.90	1.36	< 10	0/-18	6	-A
		120	B332IUNVHP-A	0.55	66	> .99	0.90	1.36	< 10	0/-18	6	-A
		277	B332IUNVHP-A	0.25	65	> .90	0.90	1.38	< 10	0/-18	6	-A
		3	PAR-PS	120	B332PUNVEL-A	0.46	55	> .99	0.73	1.34	< 10	-20/-29
277	B332PUNVEL-A			0.20	54	> .97	0.73	1.36	< 10	-20/-29	49	-A
120	B332PUNVHE-A			0.53	63	> .90	0.89	1.40	< 10	-20/-29	49	-A
277	B332PUNVHE-A			0.23	62	> .90	0.89	1.43	< 10	-20/-29	49	-A
120	B332PUNVHEH-A			0.72	86	> .98	1.18	1.36	< 10	-20/-29	49	-A
277	B332PUNVHEH-A			0.31	85	> .98	1.18	1.38	< 10	-20/-29	49	-A
120	B432PUNVHEH-E			0.69	82	> .99	1.13	1.37	< 10	-20/-29	49	-E
277	B432PUNVHEH-E			0.31	82	> .95	1.13	1.38	< 10	-20/-29	49	-E

* For Residential Use Only

See page 1-18 for Dimensions and Wiring Diagrams

TRIAD® ELECTRONIC BALLASTS

FOR (3) & (4) F25T8 LAMPS

- Low Profile Designs Featured
- Instant & Programmed Rapid Starting Options
- 3-4 Lamp Applications

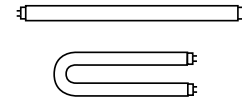

F25T8

Lamp		Line Volts	Catalog Number	Line Current (Amps)	Input Power (Watts)	Power Factor (PF)	Ballast Factor (BF)	Ballast Efficacy Factor (BEF)	THD %	Min. F/C Start Temp	Wiring Diag.	Dim.	
Qty.	Starting Method												
F25T8 - Four Lamp Applications													
4	PAR-IS	120	B432I120RES-A*	1.13	85	> .50	0.90	1.06	< 130	0/-18	7a	-A	
		347	B432I347HPL	0.24	83	> .98	0.78	0.94	< 10	0/-18	7	ST	
		120	B432IUNVHP-A	0.72	87	> .99	0.89	1.02	< 10	0/-18	7a	-A	
		277		0.32	85	> .95		1.05					
		347	B432I347HP	0.26	90	> .98	0.90	1.00	< 10	0/-18	7a	ST	
		120	B432IUNVEL-A	0.65	78	> .98	0.78	1.00	< 10	0/-18	7a	-A	
	277	0.28		76	> .98	1.03							
	120	B432IUNVHE-A	0.72	87	> .99	0.89	1.02	< 10	0/-18	7a	-A		
	277		0.31	85	> .98		1.05						
	4	PAR-PS	120	B432PUNVEL-A	0.61	73	> .99	0.72	0.98	< 10	-20/-29	50	-A
			277		0.27	72	> .97		1.00				
			120	B432PUNVHE-A	0.73	87	> .90	0.88	1.01	< 10	-20/-29	50	-A
277			0.31		84	> .90	1.04						
120			B432PUNVHEH-E	0.94	112	> .99	1.18	1.06	< 10	-20/-29	50	-E	
277				0.91	108	> .95		1.09					
F25T8ES (22W) - One Lamp Applications													
1	IS	120	B132IUNVHE-N	0.16	19	> .99	0.89	4.68	< 10	60/16	3a	-N	
		277		0.07		> .98							
		120	B232IUNVHP-N	0.20	24	> .99	1.14	4.74	< 10	60/16	3a	-N	
		277		0.09		> .98							
F25T8ES (22W) - Two Lamp Applications													
2	IS	120	B232IUNVHP-N	0.31	37	> .99	0.89	2.43	< 10	60/16	3	-N	
		277		0.13	36	> .99		2.46					

* For Residential Use Only

¹ Consult Lamp Manufacturers for applications with Ballast Factor > 1.20

See page 1-18 for Dimensions and Wiring Diagrams

Fluorescent-Electronic

Overall Dimensions		Mounting Dimensions			
Draw #	L	W	H	M	X
ST	9.50"	2.40"	1.55"	8.89"	1.69"
-A	9.50"	1.70"	1.18"	8.89"	1.69"
-B	9.50"	1.50"	1.00"	8.89"	0.88"
-C	14.25"	1.18"	1.00"	13.75"	---
-G	9.50"	1.18"	1.00"	8.89"	---
-N	9.50"	1.30"	1.00"	8.89"	---
ESA	9.50"	1.56"	1.00"	8.88"	0.78"

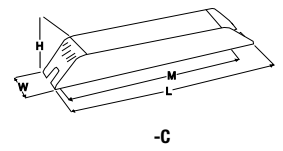
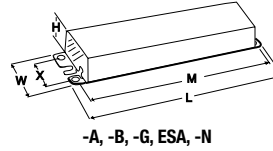
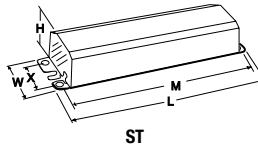

WIRING DIAGRAMS

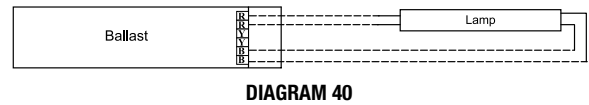
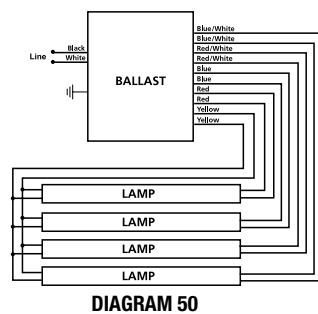
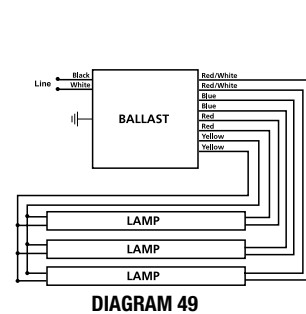
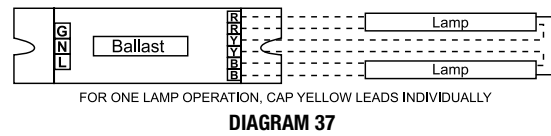
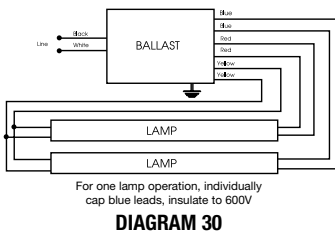
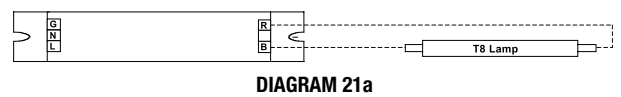
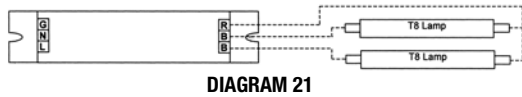
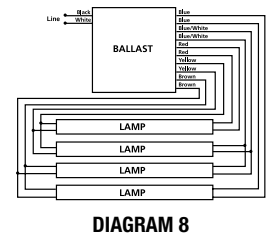
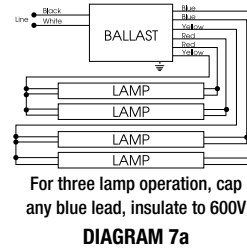
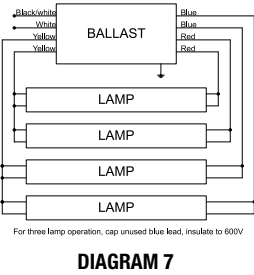
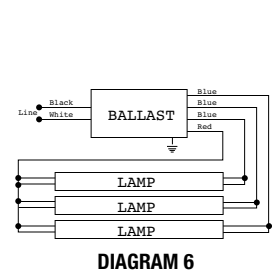
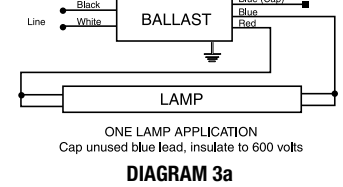
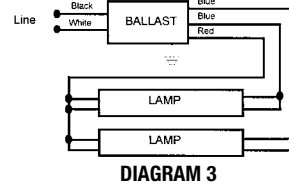
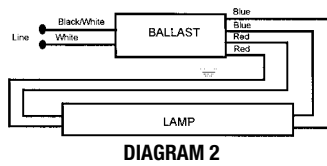
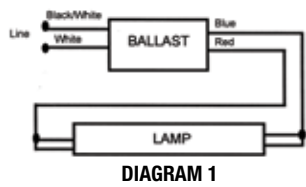

TRIAD® ELECTRONIC BALLASTS

FOR (1) F32T8 LAMP

- Low Profile Designs Featured
- Instant & Programmed Rapid Starting Options
- 1 Lamp Applications

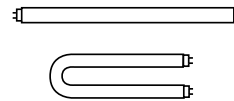

F32T8

Lamp		Line Volts	Catalog Number	Line Current (Amps)	Input Power (Watts)	Power Factor (PF)	Ballast Factor (BF)	Ballast Efficacy Factor (BEF)	THD %	Min. F/C Start Temp	Wiring Diag.	Dim.
Qty.	Starting Method											
F32T8 - One Lamp Applications												
1	IS	120	B132IUNVHP-N	0.25	30	> .98	0.88	2.93	< 10	0/-18	1	-N
		277		0.11								
		347	B132I347HP	0.09	31	> .98	0.88	2.84	< 10	0/-18	1	ST
		120	B132IUNVEL-A	0.22	25	> .98	0.77	3.08	< 10	0/-18	1	-A
		277		0.11		> .95						
		120	B132IUNVHE-N	0.25	28	> .99	0.87	3.11	< 10	0/-18	1	-N
		277		0.11								
		120	B232I120RES-A*	0.53	35	> .50	1.06	3.03	< 135	0/-18	3	-A
		120	B232I120RES-G*	0.53	36	> .50	1.06	2.94	< 150	0/-18	3	-G
		347	B232I347HPL	0.09	32	> .98	0.91	2.84	< 10	0/-18	3	ST
		120	B232IUNVHP-N	0.29	35	> .99	1.04	2.99	< 10	0/-18	3	-N
		277		0.13	34	> .98		3.03				
		347	B232I347HP-A	0.11	36	> .95	1.05	2.92	< 10	0/-18	3	-A
		120	B232IUNV-C	0.29	35	> .98	1.02	2.91	< 10	0/-18	22	-C
		277		0.13								
		120	B232IUNVEL-A ²	0.24	30	> .95	0.95	3.17	< 10	0/-18	3	-A
		277		0.11								
		120	B232IUNVEL-N	0.26	31	> .95	0.91	2.95	< 10	0/-18	3	-N
		277		0.11	30			2.98				
		120	B232IUNVHE-A	0.28	33	> .95	1.05	3.18	< 10	0/-18	3	-A
277		0.13										
120	B232IUNVHEH-A ¹	0.39	47	> .95	1.38	2.94	< 10	-20/-29	3	-A		
277		0.18	46			3.00						
1	PS	120	B132PUNVHP-A	0.26	31	> .99	0.88	2.84	< 10	0/-18	2	-A
		277		0.11	30	> .98		2.93				
		347	ES1510A	0.09	31	> .97	0.87	2.81	< 10	0/-18	40	ESA
		120	B232PUNVHE-B	0.29	35	> .90	1.01	2.90	< 10	-20/-29	30	-B
		277		0.13	34			2.98				
		120	B232PUNVEL-B	0.24	29	> .99	0.83	2.88	< 10	-20/-29	30	-B
		277		0.12	28	> .93		3.02				
120	B232PUNVHEH-A ¹	0.40	47	> .99	1.34	2.86	< 10	-20/-29	30	-A		
277		0.18										

* For Residential Use Only

¹ Consult Lamp Manufacturers for applications with Ballast Factor > 1.20

² Consult Universal for availability

See page 1-23 for Dimensions and Wiring Diagrams

IS = Instant Start
PS = Programmed Start

RS = Rapid Start
PAR-IS = Parallel Instant Start

STARTING METHOD LEGEND
PAR-PS = Parallel Programmed Start
SER-PS = Series Programmed Start

PAR-RS = Parallel Rapid Start
SER-IS = Series Instant Start
SER-RS = Series Rapid Start

Fluorescent-Electronic

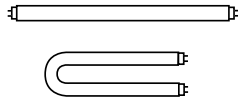

- Low Profile Designs Featured
- Instant & Programmed Rapid Starting Options
- 2 Lamp Applications

TRIAD® ELECTRONIC BALLASTS FOR (2) F32T8 LAMPS

Lamp		Line Volts	Catalog Number	Line Current (Amps)	Input Power (Watts)	Power Factor (PF)	Ballast Factor (BF)	Ballast Efficacy Factor (BEF)	THD %	Min. F/C Start Temp	Wiring Diag.	Dim.
Qty.	Starting Method											
F32T8 - Two Lamp Applications												
2	PAR-IS	120	B232I120RES-A*	0.80	56	> .50	0.88	1.57	< 120	0/-18	3	-A
		120	B232I120RES-G*	0.80	56	> .50	0.88	1.57	< 130	0/-18	3	-G
		347	B232I347HPL	0.14	50	> .99	0.78	1.56	< 10	0/-18	3	ST
		120	B232IUNVHP-N	0.47	55	> .99	0.86	1.58	< 10	0/-18	3	-N
		277		0.20								
		347	B232I347HP-A	0.17	58	> .99	0.88	1.52	< 10	0/-18	3	-A
		120	B232IUNV-C	0.48	56	> .98	0.88	1.52	< 10	0/-18	21	-C
		277		0.20								
		120	B232IUN104-A	0.54	64	> .99	1.04	1.57	< 10	0/-18	3	-A
		277		0.24								
		120	B232IUNVEL-A ²	0.40	48	> .95	0.77	1.60	< 10	0/-18	3	-A
		277		0.17								
		120	B232IUNVEL-N	0.42	48	> .95	0.77	1.60	< 10	0/-18	3	-N
		277		0.18								
		120	B232IUNVHE-A	0.45	54	> .95	0.87	1.58	< 10	0/-18	3	-A
		277		0.20								
		120	B232IUNVHEH-A	0.62	73	> .95	1.18	1.59	< 10	-20/-29	3	-A
		277		0.26								
		347	B332IHRVHB-E ¹	0.22	76	> .97	1.22	1.61	< 10	-20/-29	46	-E
		480		0.17								
347	B332I347HPL	0.16	56	> .99	0.87	1.55	< 10	0/-18	6	ST		
120	B332IUNVHP-A	0.53	63	> .99	0.99	1.57	< 10	0/-18	6	-A		
277		0.24										
347	B332I347HP	0.19	66	> .99	0.99	1.50	< 10	0/-18	6	ST		
120	B332IUNVEL-A	0.48	56	> .97	0.89	1.56	< 10	0/-18	6	-A		
277		0.21										
120	B332IUNVHE-A	0.53	63	> .98	0.99	1.55	< 10	0/-18	6	-A		
277		0.23										

* For Residential Use Only

1 Consult Lamp Manufacturers for applications with Ballast Factor > 1.20

2 Consult Universal for availability

See page 1-23 for Dimensions
and Wiring Diagrams

TRIAD® ELECTRONIC BALLASTS

FOR (2) & (3) F32T8 LAMPS

- Low Profile Designs Featured
- Instant & Programmed Rapid Starting Options
- 2 & 3 Lamp Applications

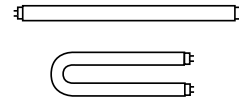

F32T8

Lamp		Line Volts	Catalog Number	Line Current (Amps)	Input Power (Watts)	Power Factor (PF)	Ballast Factor (BF)	Ballast Efficacy Factor (BEF)	THD %	Min. F/C Start Temp	Wiring Diag.	Dim.
Qty.	Starting Method											
F32T8 - Two Lamp Applications												
2	SER-PS	347	ES1329A	0.17	59	> .97	0.87	1.47	<10	0/-18	37	ESA
		120	B232PUNVHE-B	0.46	55	> .90	0.88	1.59	<10	-20/-29	30	-B
		277		0.20	54	> .97	0.71	1.60	<10	-20/-29	30	-B
		120	B232PUNVEL-B	0.38	46	> .99	0.71	1.56	<10	-20/-29	30	-B
		277		0.16	44	> .97	0.71	1.60	<10	-20/-29	30	-B
		120	B232PUNVHEH-A	0.65	77	> .99	1.17	1.52	<10	-20/-29	30	-A
277	0.28	76		> .99	1.17	1.54	<10	-20/-29	30	-A		
2	PAR-PS	120	B332PUNVHE-A	0.54	65	> .90	1.03	1.59	<10	-20/-29	30	-A
		277		0.24	64	> .90	1.03	1.61	<10	-20/-29	30	-A
		120	B332PUNVEL-A	0.44	53	> .99	0.87	1.65	<10	-20/-29	30	-A
		277		0.20	52	> .96	0.87	1.68	<10	-20/-29	30	-A
		120	B332PUNVHEH-A ¹	0.70	84	> .99	1.30	1.54	<10	-20/-29	30	-A
		277		0.30	83	> .99	1.30	1.57	<10	-20/-29	30	-A
F32T8 - Three Lamp Applications												
3	SER-IS	347	B332IHRVHB-E	0.32	110	> .98	1.18	1.07	< 10	-20/-29	46	-E
		480		0.24	109	> .95	1.18	1.08	< 10	-20/-29	46	-E
		347	B332I347HPL	0.21	75	> .99	0.79	1.05	< 10	0/-18	6	ST
		120	B332IUNVHP-A	0.71	84	> .99	0.88	1.05	< 10	0/-18	6	-A
		277		0.31	83	> .98	0.88	1.06	< 10	0/-18	6	-A
		347	B332I347HP	0.25	88	> .99	0.88	1.00	< 10	0/-18	6	ST
3	PAR-IS	120	B332IUNVEL-A	0.61	74	> .99	0.77	1.04	< 10	0/-18	6	-A
		277		0.26	73	> .98	0.77	1.05	< 10	0/-18	6	-A
		120	B332IUNVHE-A	0.70	83	> .99	0.87	1.05	< 10	0/-18	6	-A
		277		0.30	81	> .98	0.87	1.07	< 10	0/-18	6	-A
		120	B432I120RES-A*	1.20	92	> .50	0.96	1.04	< 130	0/-18	7a	-A
		347	B432I347HPL	0.24	83	> .98	0.87	1.05	< 10	0/-18	7	ST
		120	B432IUNVHP-A	0.77	92	> .99	0.94	1.02	< 10	0/-18	7a	-A
		277		0.34	89	> .95	0.94	1.06	< 10	0/-18	7a	-A
		347	B432I347HP	0.28	92	> .98	0.99	1.08	< 10	0/-18	7a	ST
		120	B432IUNVEL-A	0.67	80	> .99	0.86	1.08	< 10	0/-18	7a	-A
		277		0.29	78	> .98	0.86	1.10	< 10	0/-18	7a	-A
		120	B432IUNVHE-A	0.74	89	> .99	0.94	1.06	< 10	0/-18	7a	-A
277	0.32	87		> .98	0.94	1.08	< 10	0/-18	7a	-A		

* For Residential Use Only

¹ Consult lamp manufacturers for applications with Ballast Factor > 1.20

² Consult Universal for Availability

See page 1-23 for Dimensions and Wiring Diagrams

Fluorescent-Electronic

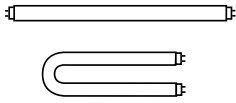

- Low Profile Designs Featured
- Instant & Programmed Rapid Starting Options
- 4 Lamp Applications

TRIAD® ELECTRONIC BALLASTS FOR (3) & (4) F32T8 LAMPS

Lamp		Line Volts	Catalog Number	Line Current (Amps)	Input Power (Watts)	Power Factor (PF)	Ballast Factor (BF)	Ballast Efficacy Factor (BEF)	THD %	Min. F/C Start Temp	Wiring Diag.	Dim.	
Qty.	Starting Method												
F32T8 - Three Lamp Applications													
3	PAR-PS	120	B332PUNVHE-A	0.70	84	> .90	0.88	1.05	<10	-20/-29	49	-A	
		277		0.30	82			1.07					
		120	B332PUNVEL-A	0.58	70	> .99	0.71	1.02	<10	-20/-29	49	-A	
		277		0.25	69	> .98		1.03					
		120	B332PUNVHEH-A	0.93	112	> .99	1.15	1.03	<10	-20/-29	49	-A	
		277		0.40	109			1.06					
			120	B432PUNVHE-A	0.75	90	> .90	0.95	1.06	<10	-20/-29	49	-A
	277			0.32	87			1.09					
	120		B432PUNVEL-A	0.66	79	> .99	0.77	0.97	<10	-20/-29	49	-A	
	277			0.29	77	> .97		1.00					
	120		B432PUNVHEH-E	0.87	103	> .99	1.12	1.08	<10	-20/-29	49	-A	
	277			0.38	102	> .97		1.10					
F32T8 - Four Lamp Applications													
4	PAR-IS	120	B432I120RES-A*	1.40	109	> .50	0.87	0.80	< 130	0/-18	7a	-A	
		347	B432I347HPL	0.29	101	> .99	0.78	0.77	< 10	0/-18	7	ST	
		120	B432IUNVHP-A	0.93	110	> .99	0.88	0.80	< 10	0/-18	7a	-A	
		277		0.40	108	> .98		0.81					
		347	B432I347HP	0.33	114	> .99	0.88	0.77	< 10	0/-18	7a	ST	
		277		0.34	96	> .98	0.77	0.79	< 10	0/-18	7a	-A	
		PAR-PS	120	B432IUNVEL-A	0.80	97	> .99	0.77	0.79	< 10	0/-18	7a	-A
	277			0.34	96	> .98		0.80					
	120		B432IUNVHE-A	0.91	109	> .99	0.87	0.80	< 10	0/-18	7a	-A	
	277			0.38	106			0.82					
	120		B432PUNVHE-A	0.91	109	> .90	0.87	0.80	<10	-20/-29	50	-A	
	277			0.39	107			0.82					
		120	B432PUNVEL-A	0.76	91	> .99	0.71	0.78	<10	-20/-29	50	-A	
277			0.33	90	> .98		0.79						
120		B432PUNVHEH-E	1.20	143	> .99	1.15	0.81	<10	-20/-29	50	-E		
277			0.50	141	> .98		0.82						

* For Residential Use Only
² Consult Universal for Availability

See page 1-23 for Dimensions and Wiring Diagrams

STARTING METHOD LEGEND
 IS = Instant Start RS = Rapid Start PAR-PS = Parallel Programmed Start PAR-RS = Parallel Rapid Start SER-IS = Series Instant Start
 PS = Programmed Start PAR-IS = Parallel Instant Start SER-PS = Series Programmed Start SER-RS = Series Rapid Start

TRIAD® ELECTRONIC BALLASTS

FOR F32T8 LAMPS

F32T8

Overall Dimensions		Mounting Dimensions			
Draw #	L	W	H	M	X
ST	9.50"	2.40"	1.55"	8.89"	1.69"
-A	9.50"	1.70"	1.18"	8.89"	1.69"
-B	9.50"	1.50"	1.00"	8.89"	0.88"
-C	14.25"	1.18"	1.00"	13.75"	---
-E	16.88"	1.74"	1.18"	16.28"	---
-G	9.50"	1.18"	1.00"	8.89"	---
-N	9.50"	1.30"	1.00"	8.89"	---
ESA	9.50"	1.56"	1.00"	8.88"	0.78"

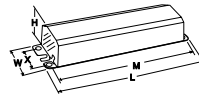

ST

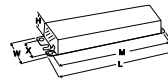

-A, -B, -E, -G, ESA, -N

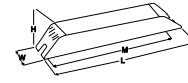

-C

WIRING DIAGRAMS

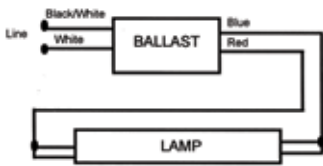

DIAGRAM 1

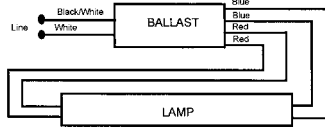
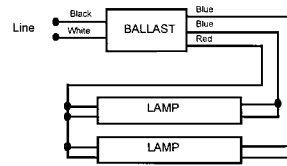
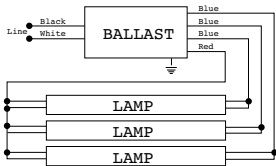

DIAGRAM 2



For one lamp operation, individually cap unused blue lead, insulate to 600V
DIAGRAM 3



For Two Lamp operation,
insulate one blue lead to 600V
DIAGRAM 6

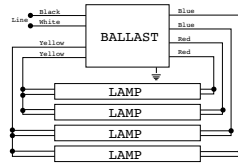

For Three Lamp Operation,
insulate one blue lead to 600V
DIAGRAM 7

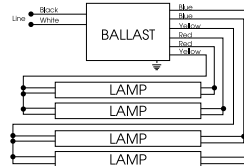

For three lamp operation, cap any blue lead, insulate to 600V
DIAGRAM 7a

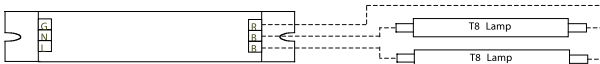

DIAGRAM 21

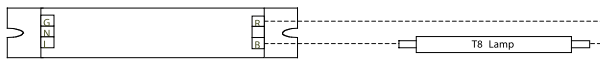
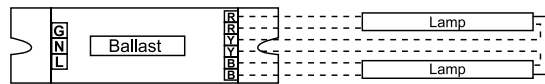

DIAGRAM 22



FOR ONE LAMP OPERATION, CAP YELLOW LEADS INDIVIDUALLY
DIAGRAM 37

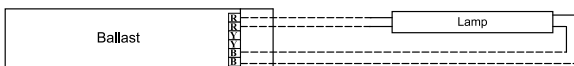

DIAGRAM 40

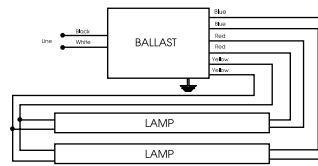
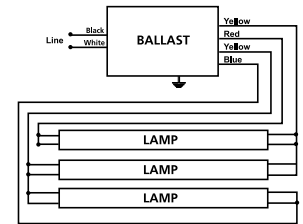

DIAGRAM 30



For two lamp application, cap one yellow lead, insulate to 600 volts
DIAGRAM 46

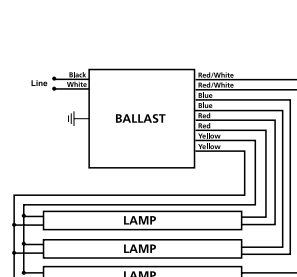

DIAGRAM 49

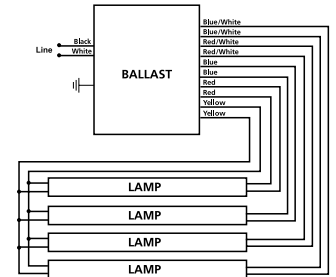
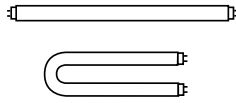

DIAGRAM 50

Fluorescent-Electronic

F32T8ES 30 WATT



- High Performance Models and Low Profile Designs
- Instant and Programmed Rapid Starting Options
- 1-2 Lamp Applications

TRIAD® ELECTRONIC BALLASTS FOR (1) & (2) F32T8ES(30 WATT) LAMPS

Lamp		Line Volts	Catalog Number	Line Current (Amps)	Input Power (Watts)	Power Factor (PF)	Ballast Factor (BF)	Ballast Efficacy Factor (BEF)	THD %	Min. F/C Start Temp	Wiring Diag.	Dim.
Qty.	Starting Method											
F32T8ES(30W) - One Lamp Applications												
1	IS	120	B132IUNVEL-A	0.22	25	> .98	0.77	3.08	< 10	60/16	1	-A
		277		0.11		> .95						
		120	B132IUNVHE-N	0.24	26	> .99	0.87	3.35	< 10	60/16	1	-N
		277		0.10								
		120	B132IUNVHP-N	0.24	28	> .98	0.88	3.14	< 10	60/16	1	-N
		277		0.10								
		347	B232I347HP-A	0.10	34	> .98	1.04	3.06	< 10	60/16	3a	-A
		120	B232IUNVEL-A ²	0.23	28	> .95	0.92	3.92	< 10	60/16	3a	-A
		277		0.11								
		120	B232IUNVEL-N	0.24	29	> .95	0.89	3.04	< 10	60/16	3a	-N
277		0.10			0.88	3.08						
120	B232IUNVHE-A	0.25	32	> .95	1.05	3.28	< 10	60/16	3a	-A		
277		0.12										
120	B232IUNVHP-N	0.27	33	> .99	1.02	3.14	< 10	60/16	3a	-N		
277		0.12		> .98	1.03	3.21						
120	B232IUNVHEH-A ¹	0.37	43	> .95	1.38	3.21	< 10	60/16	3a	-A		
277		0.16										
120	B132PUNVHP-A	0.23	28	> .99	0.88	3.14	< 10	60/16	2	-A		
277		0.10		> .98								
1	PS	120	B232PUNVEL-B	0.23	28	> .99	0.83	3.01	< 10	60/16	30	-B
		277		0.12	27	> .93	3.12					
		120	B232PUNVHE-B	0.27	32	> .90	1.01	3.12	< 10	60/16	30	-B
		277		0.12	30		3.34					
		120	B232PUNVHE-B	0.27	32	> .90	1.01	3.12	< 10	60/16	30	-B
		277		0.12	30		3.34					
120	B232PUNVHEH-A ¹	0.38	47	> .98	1.34	2.85	< 10	60/16	30	-A		
277		0.17										
F32T8ES(30W) - Two Lamp Applications												
2	SER-IS	347	B332IHRVHB-E ¹	0.21	71	> .97	1.22	1.72	< 10	60/16	46	-E
		480		0.16		> .90						
2	PAR-IS	120	B332IUNV104-A	0.50	61	> .99	1.04	1.72	< 10	60/16	3	-A
		277		0.23		> .94	1.75					
		120	B232IUNVEL-A ²	0.38	46	> .95	0.77	1.67	< 10	60/16	3	-A
		277		0.17								
		120	B232IUNVEL-N	0.40	47	> .95	0.75	1.57	< 10	60/16	3	-N
		277		0.17			1.60					
		120	B232IUNVHP-N	0.44	53	> .99	0.86	1.64	< 10	60/16	3	-N
		277		0.19	51		1.69					
		120	B232IUNVHE-A	0.42	52	> .95	0.87	1.67	< 10	60/16	3	-A
		277		0.19	51		1.71					
120	B232IUNVHEH-A	0.59	70	> .95	1.18	1.69	< 10	60/16	3	-A		
277		0.25	68		1.74							
347	B232I347HP-A	0.15	53	> .98	0.88	1.66	< 10	60/16	3	-A		
120	B332IUNVEL-A	0.46	54	> .99	0.89	1.65	< 10	60/16	6	-A		
277		0.20	53	> .98	0.89	1.68						
120	B332IUNVHE-A	0.49	59	> .99	0.99	1.68	< 10	60/16	6	-A		
277		0.21	57	> .97	0.99	1.74						
120	B332IUNVHP-A	0.50	59	> .99	0.99	1.68	< 10	60/16	6	-A		
277		0.22		> .95								

¹ Consult lamp manufacturers for applications with Ballast Factor > 1.20

² Consult Universal for availability

See page 1-31 for Dimensions and Wiring Diagrams

TRIAD® ELECTRONIC BALLASTS

FOR (2)(cont.), (3) & (4) F32T8ES LAMPS

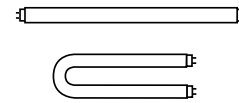

F32T8ES
30 WATT

Lamp		Line Volts	Catalog Number	Line Current (Amps)	Input Power (Watts)	Power Factor (PF)	Ballast Factor (BF)	Ballast Efficacy Factor (BEF)	THD %	Min. F/C Start Temp	Wiring Diag.	Dim.
Qty.	Starting Method											
F32T8ES(30W) - Two Lamp Applications												
2	PAR-PS	120	B232PUNVEL-B	0.36	43	> .99	0.71	1.64	<10	60/16	30	-B
		277		0.15	42	> .97		1.71				
		120	B232PUNVHE-B	0.42	50	> .90	0.88	1.75				
		277		0.18	48	> .90		1.82				
		120	B232PUNVHEH-A ¹	0.61	75	> .99	1.26	1.68				
		277		0.26	74	> .99		1.70				
	120	B332PUNVEL-A	0.41	49	> .99	0.87	1.77					
	277		0.18	48	> .96		1.82					
	120	B332PUNVHE-A	0.50	60	> .90	1.03	1.72					
	277		0.22	59	> .90		1.73					
	120	B332PUNVHEH-A ¹	0.66	82	> .99	1.30	1.59					
	277		0.29	81	> .99		1.60					
F32T8ES(30W) - Three Lamp Applications												
3	SER-IS	347	B332IHRVHB-E	0.30	102	> .98	1.18	1.16	< 10	60/16	46	-E
		480		0.22	101	> .95		1.17				
3	PAR-IS	120	B332IUNVEL-A	0.58	70	> .99	0.77	1.10	< 10	60/16	6	-A
		277		0.25	69	> .98		1.12				
		120	B332IUNVHE-A	0.65	79	> .99	0.87	1.10				
		277		0.28	77	> .98		1.13				
		120	B332IUNVHP-A	0.66	79	> .99	0.89	1.13				
		277		0.29	77	> .95		1.16				
	347	B432I347HP	0.26	88	> .98	0.99	1.13	< 10	60/16	7a	ST	
	120	B432IUNVEL-A	0.62	75	> .99	0.86	1.15					
	277		0.27	73	> .98		1.18					
	120	B432IUNVHE-A	0.70	84	> .98	0.96	1.14					
	277		0.30	82	> .98		1.17					
	120	B432IUNVHP-A	0.72	86	> .98	0.96	1.12					
277	0.32		84	> .95	1.14							
3	PAR-PS	120	B332PUNVEL-A	0.53	64	> .99	0.71	1.12	<10	60/16	49	-A
		277		0.23	63	> .97		1.13				
		120	B332PUNVHEH-A	0.89	106	> .99	1.15	1.08				
		277		0.38	104	> .99		1.11				
		120	B332PUNVHE-A	0.65	78	> .90	0.88	1.13				
		277		0.28	76	> .90		1.15				
	120	B432PUNVEL-A	0.60	72	> .99	0.77	1.07					
	277		0.26	71	> .97		1.09					
	120	B432PUNVHE-A	0.74	89	> .90	0.95	1.07					
	277		0.31	84	> .90		1.13					
	120	B432PUNVHEH-E	0.84	99	> .99	1.13	1.14					
	277		0.37	98	> .96		1.15					

¹ Consult lamp manufacturers for applications with Ballast Factor > 1.20

See page 1-31 for Dimensions and Wiring Diagrams

Fluorescent-Electronic

F32T8ES (30W -25W)

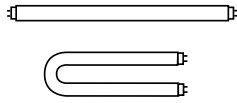

- High Performance Models and Low Profile Designs
- 1-2 Lamp Applications

TRIAD® ELECTRONIC BALLASTS

FOR (1) & (2) F32T8ES (25 WATT) LAMPS

Lamp		Line Volts	Catalog Number	Line Current (Amps)	Input Power (Watts)	Power Factor (PF)	Ballast Factor (BF)	Ballast Efficacy Factor (BEF)	THD %	Min. F/C Start Temp	Wiring Diag.	Dim.
Qty.	Starting Method											
F32T8ES(30W) - Four Lamp Applications												
4	PAR-IS	347	B432I347HP	0.31	106	> .99	0.88	0.83	< 10	60/16	7a	ST
		120	B432IUNVEL-A	0.75	91	> .99	0.77	0.85	< 10	60/16	7a	-A
		277	B432IUNVHE-A	0.32	90	> .98	0.87	0.86	< 10	60/16	7a	-A
		120	B432IUNVHE-A	0.85	103	> .99	0.87	0.84	< 10	60/16	7a	-A
		277	B432IUNVHE-A	0.36	100	> .98	0.87	0.87	< 10	60/16	7a	-A
		120	B432IUNVHP-A	0.87	104	> .98	0.88	0.85	< 10	60/16	7a	-A
4	PAR-PS	277	B432IUNVHP-A	0.38	101	> .95	0.88	0.87	< 10	60/16	7a	-A
		120	B432PUNVEL-A	0.71	85	> .99	0.71	0.83	< 10	60/16	50	-A
		277	B432PUNVEL-A	0.31	84	> .98	0.71	0.84	< 10	60/16	50	-A
		120	B432PUNVHE-A	0.86	103	> .90	0.87	0.84	< 10	60/16	50	-A
		277	B432PUNVHE-A	0.37	101	> .90	0.87	0.86	< 10	60/16	50	-A
		120	B432PUNVHEH-E	1.14	135	> .99	1.18	0.87	< 10	60/16	50	-E
277	B432PUNVHEH-E	0.50	134	> .97	1.18	0.88	< 10	60/16	50	-E		
F32T8ES (25W) - One Lamp Applications												
1	IS	120	B132IUNVEL-A	0.17	20	> .98	0.77	3.85	< 10	60/16	1	-A
		277	B132IUNVEL-A	0.07	20	> .95	0.77	3.85	< 10	60/16	1	-A
		120	B132IUNVHE-N	0.20	23	> .99	0.87	3.78	< 10	60/16	1	-N
		277	B132IUNVHE-N	0.09	23	> .99	0.87	3.78	< 10	60/16	1	-N
		120	B132IUNVHP-N	0.20	24	> .98	0.88	3.67	< 10	60/16	1	-N
		277	B132IUNVHP-N	0.09	24	> .98	0.88	3.67	< 10	60/16	1	-N
		120	B232IUNVEL-A ²	0.20	24	> .99	0.95	3.96	< 10	60/16	3a	-A
		277	B232IUNVEL-A ²	0.09	25	> .95	0.95	3.80	< 15	60/16	3a	-A
		120	B232IUNVEL-N	0.20	24	> .99	0.84	3.54	< 10	60/16	3a	-N
		277	B232IUNVEL-N	0.09	24	> .95	0.85	3.55	< 15	60/16	3a	-N
		120	B232IUNVHE-A	0.23	27	> .98	1.05	3.89	< 10	60/16	3a	-A
		277	B232IUNVHE-A	0.10	27	> .95	1.05	3.89	< 10	60/16	3a	-A
1	PS	120	B232IUNVHP-N	0.22	27	> .99	0.96	3.60	< 10	60/16	3a	-N
		277	B232IUNVHP-N	0.10	26	> .98	0.96	3.64	< 10	60/16	3a	-N
		120	B232IUNVHEH-A ¹	0.32	38	> .95	1.38	3.63	< 10	60/16	3a	-A
		277	B232IUNVHEH-A ¹	0.14	37	> .95	1.38	3.73	< 10	60/16	3a	-A
		120	B132PUNVHP-A	0.21	25	> .99	0.88	3.52	< 10	60/16	2	-A
		277	B132PUNVHP-A	0.09	25	> .99	0.88	3.52	< 10	60/16	2	-A
		120	B232PUNVEL-B	0.20	24	> .99	0.83	3.49	< 10	60/16	30	-B
		277	B232PUNVEL-B	0.11	23	> .92	0.83	3.58	< 10	60/16	30	-B
		120	B232PUNVHE-B	0.23	28	> .90	1.05	3.80	< 10	60/16	30	-B
		277	B232PUNVHE-B	0.12	27	> .90	1.05	3.88	< 10	60/16	30	-B
		120	B232PUNVHEH-A ¹	0.33	36	> .98	1.36	3.81	< 10	60/16	30	-A
		277	B232PUNVHEH-A ¹	0.14	36	> .98	1.35	3.72	< 10	60/16	30	-A
F32T8ES (25W) - Two Lamp Applications												
2	SER-IS	347	B332IHRVHB-E	0.18	61	> .95	1.14	1.87	< 10	60/16	46	-E
		480	B332IHRVHB-E	0.14	61	> .90	1.14	1.87	< 10	60/16	46	-E
2	PAR-IS	120	B232IUNV104-A	0.42	52	> .99	1.04	1.92	< 10	60/16	3	-A
		277	B232IUNV104-A	0.20	52	> .93	1.04	1.82	< 10	60/16	3	-A
		120	B232IUNVEL-A ²	0.33	39	> .99	0.77	1.97	< 10	60/16	3	-A
		277	B232IUNVEL-A ²	0.14	38	> .98	0.77	2.03	< 10	60/16	3	-A
		120	B232IUNVEL-N	0.33	39	> .99	0.72	1.83	< 10	60/16	3	-N
		277	B232IUNVEL-N	0.14	38	> .98	0.71	1.87	< 10	60/16	3	-N
		120	B232IUNVHE-A	0.37	44	> .98	0.87	1.98	< 10	60/16	3	-A
		277	B232IUNVHE-A	0.16	43	> .98	0.87	2.02	< 10	60/16	3	-A
		120	B232IUNVHP-N	0.36	43	> .99	0.78	1.84	< 10	60/16	3	-N
		277	B232IUNVHP-N	0.15	42	> .99	0.78	1.88	< 10	60/16	3	-N
2	PAR-PS	120	B232IUNVHEH-A	0.49	59	> .95	1.18	2.00	< 10	60/16	3	-A
		277	B232IUNVHEH-A	0.21	58	> .95	1.18	2.03	< 10	60/16	3	-A
		120	B332IUNVEL-A	0.37	44	> .99	0.89	2.02	< 10	60/16	6	-A
		277	B332IUNVEL-A	0.16	43	> .95	0.89	2.07	< 10	60/16	6	-A
		120	B332IUNVHE-A	0.43	51	> .98	0.99	1.94	< 10	60/16	6	-A
		277	B332IUNVHE-A	0.19	50	> .95	0.99	1.98	< 10	60/16	6	-A
120	B332IUNVHP-A	0.43	51	> .98	1.00	1.96	< 10	60/16	6	-A		
277	B332IUNVHP-A	0.20	51	> .90	1.00	1.96	< 10	60/16	6	-A		

¹ Consult lamp manufacturers for applications with Ballast Factor > 1.20

See page 1-31 for Dimensions
and Wiring Diagrams

TRIAD® ELECTRONIC BALLASTS

FOR (3) & (4) F32T8ES (25 WATT) LAMPS

- High Performance Models and Low Profile Designs
- 3-4 Lamp Applications

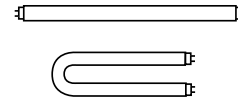

F32T8ES 25 WATT

Lamp		Line Volts	Catalog Number	Line Current (Amps)	Input Power (Watts)	Power Factor (PF)	Ballast Factor (BF)	Ballast Efficacy Factor (BEF)	THD %	Min. F/C Start Temp	Wiring Diag.	Dim.		
Qty.	Starting Method													
F32T8ES (25W) - Two Lamp Applications														
2	PAR-PS	120	B232PUNVEL-B	0.31	37	> .99	0.71	1.91	<10	60/16	30	-B		
		277		0.14	35	> .96		2.03						
		120	B232PUNVHE-B	0.36	43	> .90	0.88	2.04	<10	60/16	30	-B		
		277		0.16	41	> .90		2.14						
		120	B232PUNVHEH-A	0.51	59	> .98	1.18	2.01	<10	60/16	30	-A		
		277		0.22	58	> .98		2.02						
		120	B332PUNVEL-A	0.35	42	> .99	0.87	2.07	<10	60/16	30	-A		
		277		0.16	41	> .95		2.13						
		120	B332PUNVHE-A	0.42	50	> .90	1.04	2.07	<10	60/16	30	-A		
		277		0.18	48	> .90		2.15						
		120	B332PUNVHEH-A ¹	0.57	68	> .98	1.30	1.91	<10	60/16	30	-A		
		277		0.25	68	> .98		1.91						
		F32T8ES (25W) - Three Lamp Applications												
		3	SER-IS	347	B332IHRVHB-E	0.26	88	> .97	1.11	1.26	< 10	60/16	46	-E
480	0.19			> .90										
3	PAR-IS	120	B332IUNVEL-A	0.48	58	> .99	0.77	1.33	< 10	60/16	6	-A		
		277		0.21		> .97		1.35						
		120	B332IUNVHE-A	0.56	66	> .98	0.87	1.32	< 10	60/16	6	-A		
		277		0.24		> .95		1.34						
		120	B332IUNVHP-A	0.57	69	> .99	0.90	1.30	< 10	60/16	6	-A		
		277		0.26		> .95		1.32						
		120	B432IUNVEL-A	0.50	60	> .99	0.86	1.43	< 10	60/16	7a	-A		
		277		0.22		> .94		1.48						
		120	B432IUNVHE-A	0.60	72	> .99	0.96	1.33	< 10	60/16	7a	-A		
		277		0.26		> .95		1.35						
120	B432IUNVHP-A	0.61	73	> .98	0.97	1.33	< 10	60/16	7a	-A				
277		0.27		> .95		1.35								

See page 1-31 for Dimensions and Wiring Diagrams

Fluorescent-Electronic

F32T8ES 25 WATT

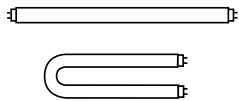

- High Performance Models and Low Profile Designs
- 1-2 Lamp Applications

TRIAD® ELECTRONIC BALLASTS

FOR (1) & (2) F32T8ES (25 WATT) LAMPS

Lamp		Line Volts	Catalog Number	Line Current (Amps)	Input Power (Watts)	Power Factor (PF)	Ballast Factor (BF)	Ballast Efficacy Factor (BEF)	THD %	Min. F/C Start Temp	Wiring Diag.	Dim.
Qty.	Starting Method											
F32T8ES (25W) - Three Lamp Applications												
3	PAR-PS	120	B332PUNVEL-A	0.46	55	> .99	0.71	1.30	<10	60/16	49	-A
		277		0.20	54	> .97		1.32				
		120	B332PUNVHE-A	0.55	66	> .90	0.88	1.34	<10	60/16	49	-A
		277		0.24	65	> .90		1.35				
		120	B332PUNVHEH-A	0.75	90	> .98	1.15	1.28	<10	60/16	49	-A
		277		0.32	88	> .98		1.31				
		120	B432PUNVEL-A	0.52	62	> .99	0.77	1.23	<10	60/16	49	-A
		277		0.23	61	> .96		1.26				
		120	B432PUNVHE-A	0.59	71	> .90	0.95	1.35	<10	60/16	49	-A
		277		0.26	70	> .90		1.35				
		120	B432PUNVHEH-E	0.76	90	> .99	1.13	1.26	<10	60/16	49	-E
		277		0.35	92	> .95		1.23				
F32T8ES (25W) - Four Lamp Applications												
4	PAR-IS	120	B432IUNVEL-A	0.62	75	> .99	0.82	1.09	<10	60/16	7a	-A
		277		0.27	73	> .95		1.12				
		120	B432IUNVHE-A	0.73	87	> .99	0.87	1.00	<10	60/16	7a	-A
		277		0.31	85	> .98		1.02				
		120	B432IUNVHP-A	0.74	90	> .98	0.89	0.99	<10	60/16	7a	-A
		277		0.33	88	> .95		1.01				
4	PAR-PS	120	B432PUNVEL-A	0.61	73	> .99	0.71	0.97	<10	60/16	50	-A
		277		0.27	72	> .97		0.98				
		120	B432PUNVHE-A	0.71	85	> .90	0.87	1.02	<10	60/16	50	-A
		277		0.31	84	> .90		1.03				
		120	B432PUNVHEH-E	1.04	124	> .99	1.18	0.96	<10	60/16	50	-E
		277		0.45	118	> .95		1.00				

See page 1-31 for Dimensions and Wiring Diagrams

STARTING METHOD LEGEND
 IS = Instant Start RS = Rapid Start PAR-PS = Parallel Programmed Start PAR-RS = Parallel Rapid Start SER-IS = Series Instant Start
 PS = Programmed Start PAR-IS = Parallel Instant Start SER-PS = Series Programmed Start SER-RS = Series Rapid Start

TRIAD® ELECTRONIC BALLASTS

FOR (1) & (2) F28T8 LAMPS

- High Performance Models and Low Profile Designs
- Instant and Programmed Rapid Starting Options
- 1-2 Lamp Applications

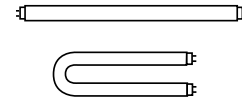

F28T8

Lamp		Line Volts	Catalog Number	Line Current (Amps)	Input Power (Watts)	Power Factor (PF)	Ballast Factor (BF)	Ballast Efficacy Factor (BEF)	THD %	Min. F/C Start Temp	Wiring Diag.	Dim.
Qty.	Starting Method											
F28T8 - One Lamp Applications												
1	IS	120	B132IUNVEL-A	0.20	21	> .98	0.77	3.67	< 10	60/16	1	-A
		277	B132IUNVEL-A	0.10	21	> .95	0.77	3.67	< 10	60/16	1	-A
		120	B132IUNVHE-N	0.20	24	> .99	0.87	3.63	< 10	60/16	1	-N
		277	B132IUNVHE-N	0.10	24	> .99	0.87	3.63	< 10	60/16	1	-N
		120	B132IUNVHP-N	0.22	26	> .98	0.88	3.38	< 10	60/16	1	-N
		277	B132IUNVHP-N	0.10	26	> .98	0.88	3.38	< 10	60/16	1	-N
		347	B232I347HP-A	0.09	32	> .98	1.04	3.25	< 10	60/16	3a	-A
	PS	120	B232IUNVEL-A ²	0.22	26	> .95	0.95	3.65	< 10	60/16	3a	-A
			277	B232IUNVEL-A ²	0.10	27	> .95	0.95	3.52	< 10	60/16	3a
		120	B232IUNVEL-N	0.23	27	> .95	0.88	3.30	< 10	60/16	3a	-N
			277	B232IUNVEL-N	0.10	26	> .95	0.88	3.31	< 10	60/16	3a
		120	B232IUNVHE-A	0.24	29	> .95	1.10	3.79	< 10	60/16	3a	-A
			277	B232IUNVHE-A	0.11	29	> .95	1.10	3.79	< 10	60/16	3a
		120	B232IUNVHEH-A ¹	0.33	40	> .95	1.38	3.45	< 10	60/16	3a	-A
277	B232IUNVHEH-A ¹		0.15	39	> .95	1.38	3.54	< 10	60/16	3a	-A	
PS	120	B232IUNVHP-N	0.25	30	> .99	0.99	3.36	< 10	60/16	3a	-N	
		277	B232IUNVHP-N	0.11	29	> .98	1.00	3.40	< 10	60/16	3a	-N
	120	B132PUNVHP-A	0.28	27	> .99	0.88	3.26	< 10	60/16	2	-A	
		277	B132PUNVHP-A	0.11	27	> .99	0.88	3.26	< 10	60/16	2	-A
	120	B232PUNVEL-B	0.21	25	> .99	0.83	3.33	< 10	60/16	30	-B	
		277	B232PUNVEL-B	0.11	24	> .92	0.83	3.46	< 10	60/16	30	-B
	120	B232PUNVHE-B	0.25	30	> .90	1.01	3.41	< 10	60/16	30	-B	
277		B232PUNVHE-B	0.12	29	> .90	1.01	3.45	< 10	60/16	30	-B	
120	B232PUNVHEH-A ¹	0.35	39	> .97	1.35	3.47	< 10	60/16	30	-A		
	277	B232PUNVHEH-A ¹	0.15	39	> .97	1.35	3.44	< 10	60/16	30	-A	
F28T8 - Two Lamp Applications												
2	SER-IS	347	B332IHRVHB-E ¹	0.19	65	> .97	1.22	1.88	< 10	60/16	46	-E
		480	B332IHRVHB-E ¹	0.15	65	> .90	1.22	1.88	< 10	60/16	46	-E
		347	B232I347HP-A	0.14	50	> .98	0.88	1.76	< 10	60/16	3	-A
		120	B232IUNV104-A	0.47	56	> .99	1.04	1.79	< 10	60/16	3	-A
		277	B232IUNV104-A	0.21	55	> .94	1.04	1.82	< 10	60/16	3	-A
		120	B232IUNVEL-A ²	0.36	43	> .95	0.77	1.79	< 10	60/16	3	-A
		277	B232IUNVEL-A ²	0.15	43	> .95	0.77	1.79	< 10	60/16	3	-A
	PAR-IS	120	B232IUNVEL-N	0.36	43	> .95	0.75	1.76	< 10	60/16	3	-N
			277	B232IUNVEL-N	0.15	42	> .95	0.74	1.76	< 10	60/16	3
		120	B232IUNVHE-A	0.40	49	> .95	0.87	1.78	< 10	60/16	3	-A
			277	B232IUNVHE-A	0.18	48	> .95	0.87	1.81	< 10	60/16	3
		120	B232IUNVHP-N	0.40	48	> .99	0.83	1.76	< 10	60/16	3	-N
			277	B232IUNVHP-N	0.17	46	> .99	0.83	1.78	< 10	60/16	3
		120	B232IUNVHEH-A	0.53	64	> .95	1.18	1.84	< 10	60/16	3	-A
277	B232IUNVHEH-A		0.23	62	> .95	1.18	1.90	< 10	60/16	3	-A	
PAR-IS	120	B332IUNVEL-A	0.41	49	> .99	0.89	1.82	< 10	60/16	6	-A	
		277	B332IUNVEL-A	0.18	48	> .95	0.89	1.85	< 10	60/16	6	-A
	120	B332IUNVHE-A	0.45	54	> .99	0.99	1.83	< 10	60/16	6	-A	
		277	B332IUNVHE-A	0.19	53	> .97	0.99	1.87	< 10	60/16	6	-A
	120	B332IUNVHP-A	0.46	55	> .99	0.99	1.80	< 10	60/16	6	-A	
		277	B332IUNVHP-A	0.21	54	> .90	0.99	1.83	< 10	60/16	6	-A

¹ Consult lamp manufacturers for applications with Ballast Factors > 1.20

² Consult Universal for availability

See page 1-31 for Dimensions and Wiring Diagrams

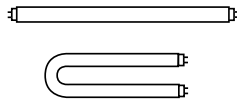

- High Performance Models and Low Profile Designs
- Instant and Programmed Rapid Starting Options
- 2-4 Lamp Applications

TRIAD® ELECTRONIC BALLASTS FOR (2)/(cont.), (3) & (4) F28T8 LAMPS

Lamp		Line Volts	Catalog Number	Line Current (Amps)	Input Power (Watts)	Power Factor (PF)	Ballast Factor (BF)	Ballast Efficacy Factor (BEF)	THD %	Min. F/C Start Temp	Wiring Diag.	Dim.	
Qty.	Starting Method												
F28T8 - Two Lamp Applications													
2	PAR-PS	120	B232PUNVEL-B	0.33	40	> .99	0.71	1.79	<10	60/16	30	-B	
		277		0.15	39	> .96		1.84					
		120	B232PUNVHE-B	0.39	46	> .90	0.88	1.90	<10	60/16	30	-B	
		277		0.17	45			1.95					
		120	B232PUNVHEH-A	0.56	64	> .99	1.18	1.85	<10	60/16	30	-A	
		277		0.24	63			1.86					
		PAR-PS	120	B332PUNVHE-A	0.45	54	> .90	1.04	1.93	<10	60/16	30	-A
	277			0.20	53			1.97					
	120		B332PUNVEL-A	0.38	46	> .99	0.87	1.91	<10	60/16	30	-A	
	277			0.17	45	> .96		1.92					
	120		B332PUNHEH-A ¹	0.60	72	> .98	1.30	1.81	<10	60/16	30	-A	
	277			0.26	71			1.83					
F28T8 - Three Lamp Applications													
3	SER-IS	347	B332IHRVHB-E	0.28	94	> .97	1.18	1.26	< 10	60/16	46	-E	
		480		0.21		> .90							
		120	B332IUNVEL-A	0.53	66	> .99	0.77	1.17	< 10	60/16	6	-A	
		277		0.23	65	> .97		1.18					
		120	B332IUNVHE-A	0.60	75	> .99	0.87	1.16	< 10	60/16	6	-A	
		277		0.26	73	> .98		1.19					
		PAR-IS	120	B332IUNVHP-A	0.61	73	> .99	0.89	1.22	< 10	60/16	6	-A
	277			0.27	71	> .95		1.25					
	347		B432I347HP	0.23	78	> .98	0.99	1.27	< 10	60/16	7a	ST	
	120		B432IUNVEL-A	0.57	69	> .99	0.86	1.25	< 10	60/16	7a	-A	
	277			0.26	68	> .95		1.26					
	120		B432IUNVHE-A	0.64	77	> .99	0.96	1.25	< 10	60/16	7a	-A	
	PAR-PS	277		0.28	75	> .98		1.28					
120		B432IUNVHP-A	0.66	79	> .98	0.97	1.23	< 10	60/16	7a	-A		
277			0.29	77	> .95	0.97	1.26						
120		B332PUNVEL-A	0.49	59	> .99	0.71	1.21	<10	60/16	49	-A		
277			0.21	58	> .97		1.22						
120		B332PUNVHE-A	0.59	71	> .90	0.88	1.25	<10	60/16	49	-A		
277			0.25	68			1.29						
120		B332PUNVHEH-A	0.79	94	> .98	1.15	1.22	<10	60/16	49	-A		
277			0.34	92			1.25						
120		B432PUNVEL-A	0.56	67	> .99	0.77	1.15	<10	60/16	49	-A		
277			0.25	66	> .97		1.17						
120		B432PUNVHE-A	0.64	77	> .90	0.95	1.24	<10	60/16	49	-A		
277		0.28	76			1.25							
120	B432PUNVHEH-E	0.76	90	> .99	1.13	1.25	<10	60/16	49	-E			
277		0.34		> .96									

¹ Consult lamp manufacturers for applications with Ballast Factors > 1.20

See page 1-31 for Dimensions and Wiring Diagrams

TRIAD® ELECTRONIC BALLASTS

FOR F32T8ES AND F28T8 LAMPS

F28T8

Fluorescent-Electronic

Lamp		Line Volts	Catalog Number	Line Current (Amps)	Input Power (Watts)	Power Factor (PF)	Ballast Factor (BF)	Ballast Efficacy Factor (BEF)	THD %	Min. F/C Start Temp	Wiring Diag.	Dim.
Qty.	Starting Method											
F28T8 - Four Lamp Applications												
4	PAR-IS	347	B432I347HP	0.28	95	> .98	0.88	0.93	< 10	60/16	7a	ST
		120	B432IUNVEL-A	0.70	85	> .99	0.77	0.91	< 10	60/16	7a	-A
		277	B432IUNVHE-A	0.31	84	> .98	0.92	0.92	< 10	60/16	7a	-A
		120	B432IUNVHE-A	0.77	97	> .99	0.87	0.90	< 10	60/16	7a	-A
		277	B432IUNVHE-A	0.33	94	> .98	0.93	0.93	< 10	60/16	7a	-A
		120	B432IUNVHP-A	0.80	96	> .98	0.89	0.93	< 10	60/16	7a	-A
4	PAR-PS	120	B432PUNVEL-A	0.64	77	> .99	0.92	0.92	<10	60/16	50	-A
		277	B432PUNVEL-A	0.28	76	> .97	0.71	0.93	<10	60/16	50	-A
		120	B432PUNVHE-A	0.77	92	> .90	0.87	0.94	<10	60/16	50	-A
		277	B432PUNVHE-A	0.33	90	> .90	0.97	0.97	<10	60/16	50	-A
		120	B432PUNVHEH-E	1.05	125	> .99	1.18	0.95	<10	60/16	50	-E
		277	B432PUNVHEH-E	0.46	125	> .98	0.94	0.94	<10	60/16	50	-E

Overall Dimensions			Mounting Dimensions		
Draw #	L	W	H	M	X
ST	9.50"	2.40"	1.55"	8.89"	1.69"
-A	9.50"	1.70"	1.18"	8.89"	1.69"
-B	9.50"	1.50"	1.00"	8.89"	1.69"
-E	16.88"	1.74"	1.18"	16.28"	---
-N	9.50"	1.30"	1.00"	8.89"	1.69"

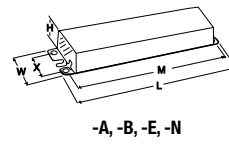
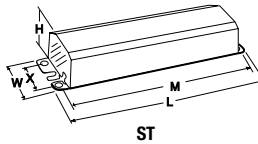

WIRING DIAGRAMS

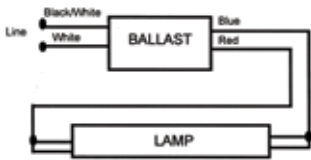

DIAGRAM 1

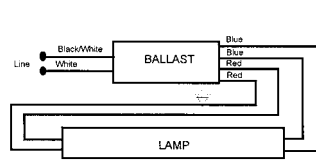

DIAGRAM 2

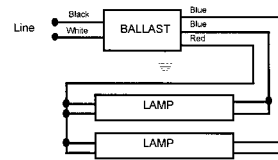
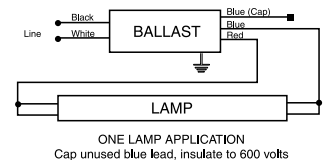
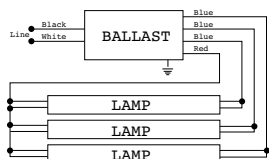

DIAGRAM 3



ONE LAMP APPLICATION
Cap unused blue lead, insulate to 600 volts

DIAGRAM 3a



For Two Lamp operation,
Insulate one blue lead to 600V

DIAGRAM 6

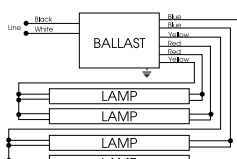

For three lamp operation, cap any
blue lead, insulate to 600V

DIAGRAM 7a

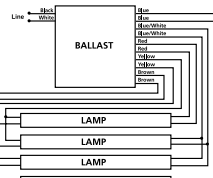

For Three Lamp Application, Individually
cap brown leads, Insulate to 600V

DIAGRAM 8

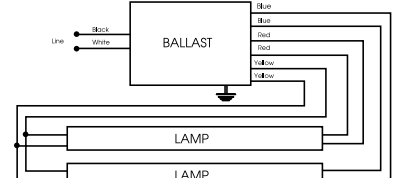

For one lamp operation, cap any
blue lead, insulate to 600V

DIAGRAM 30

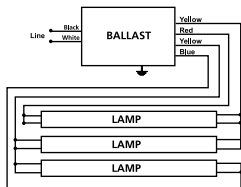

For two lamp application, cap one yellow lead,
insulate to 600 volts

DIAGRAM 46

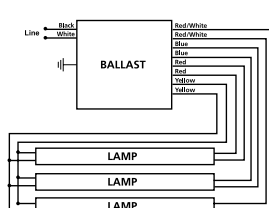

DIAGRAM 49

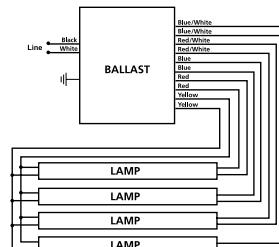
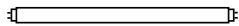

DIAGRAM 50



- Low Profile Designs Featured
- Instant & Programmed Rapid Starting Options
- 1-3 Lamp Applications

TRIAD® ELECTRONIC BALLASTS FOR (1), (2), AND (3) F40T8 LAMPS

Lamp		Line Volts	Catalog Number	Line Current (Amps)	Input Power (Watts)	Power Factor (PF)	Ballast Factor (BF)	Ballast Efficacy Factor (BEF)	THD %	Min. F/C Start Temp	Wiring Diag.	Dim.
Qty.	Starting Method											
F40T8 - One Lamp Applications												
1	IS	120	B132IUNVEL-A	0.25	32	> .98	0.76	2.38	< 10	0/-18	1	-A
		277		0.13		> .95						
		120	B132IUNVHE-N	0.30	35	> .99	0.86	2.46	< 10	0/-18	1	-N
		277		0.14								
		120	B132IUNVHP-N	0.31	37	> .99	0.86	2.32	< 10	32/0	1	-N
		277		0.13	36			2.39				
		347	B232I347HP-A	0.13	45	> .98	1.02	2.27	< 10	0/-18	3a	-A
		347	B232I347HPL	0.11	38	> .98	0.86	2.26	< 10	0/-18	3a	ST
		120	B232IUNVHP-N	0.36	44	> .99	1.03	2.34	< 10	32/0	3a	-N
		277		0.16	43			2.40				
		347	B232I347RH-A	0.13	45	> .98	1.02	2.27	< 20	0/-18	3a	-A
		120	B232IUNV-C	0.37	43	> .98	0.99	2.30	< 10	0/-18	22	-C
277		0.16	42			2.36						
1	PS	120	B232PUNVEL-B	0.28	34	> .99	0.80	2.38	< 10	-20/-29	30	-B
		277		0.13	32	> .95		2.52				
		120	B232PUNVHE-B	0.34	41	> .90	0.99	2.43	< 10	-20/-29	30	-B
277		0.15	40			2.48						
F40T8 - Two Lamp Applications												
2	PAR-IS	347	B259I347HP	0.22	76	> .98	0.91	1.20	< 10	0/-18	14	ST
		347	B332I347HPL	0.20	69	> .99	0.82	1.18	< 10	0/-18	6	ST
		120	B332IUNVEL-A	0.57	68	> .99	0.89	1.31	< 10	0/-18	6	-A
		277		0.25	66	> .98		1.35				
		120	B332IUNVHE-A	0.64	77	> .99	0.99	1.29	< 10	0/-18	6	-A
		277		0.27	75	> .98		1.32				
2	PAR-PS	120	B332IUNVHP-A	0.65	78	> .99	0.95	1.22	< 10	0/-18	6	-A
		277		0.29	77	> .95		1.23				
		120	B332PUNVEL-A	0.53	64	> .99	0.85	1.34	< 10	-20/-29	30	-A
		277		0.23	62	> .97		1.36				
		120	B332PUNVHE-A	0.64	77	> .90	1.02	1.33	< 10	-20/-29	30	-A
		277		0.27	74			1.38				

See page 1-33 for Dimensions and Wiring Diagrams

TRIAD® ELECTRONIC BALLASTS

FOR F40T8 LAMPS

F40T8

Lamp		Line Volts	Catalog Number	Line Current (Amps)	Input Power (Watts)	Power Factor (PF)	Ballast Factor (BF)	Ballast Efficacy Factor (BEF)	THD %	Min. F/C Start Temp	Wiring Diag.	Dim.
Qty.	Starting Method											
F40T8 - Three Lamp Applications												
3	PAR-IS	347	B432I347HPL	0.29	100	> .99	0.81	0.81	< 10	0/-18	7	ST
		120	B432IUNVEL-A	0.81	97	> .99	0.86	0.89	< 10	0/-18	7a	-A
		277	B432IUNVEL-A	0.35	94	> .98	0.86	0.91	< 10	0/-18	7a	-A
		120	B432IUNVHE-A	0.93	111	> .99	0.96	0.86	< 10	0/-18	7a	-A
		277	B432IUNVHE-A	0.39	107	> .98	0.96	0.90	< 10	0/-18	7a	-A
		120	B432IUNVHP-A	0.95	114	> .99	0.92	0.81	< 10	0/-18	7a	-A
3	PAR-PS	277	B432IUNVHP-A	0.41	109	> .98	0.92	0.84	< 10	0/-18	7a	-A
		120	B432PUNVEL-A	0.79	95	> .99	0.70	0.74	< 10	-20/-29	49	-A
		277	B432PUNVEL-A	0.34	92	> .98	0.70	0.76	< 10	-20/-29	49	-A
		120	B432PUNVHE-A	0.93	111	> .90	0.93	0.84	< 10	-20/-29	49	-A
		277	B432PUNVHE-A	0.40	109	> .90	0.93	0.85	< 10	-20/-29	49	-A

Overall Dimensions			Mounting Dimensions		
Draw #	L	W	H	M	X
ST	9.50"	2.40"	1.55"	8.89"	1.69"
-A	9.50"	1.70"	1.18"	8.89"	1.69"
-B	9.50"	1.50"	1.00"	8.89"	0.88"
-C	14.25"	1.18"	1.00"	13.75"	---

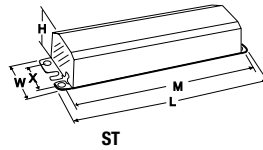

ST

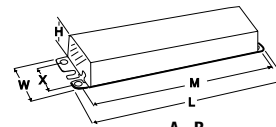

-A, -B

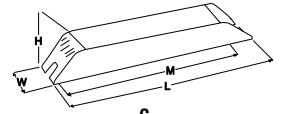

-C

WIRING DIAGRAMS

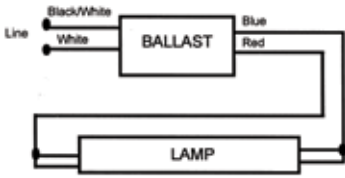

DIAGRAM 1

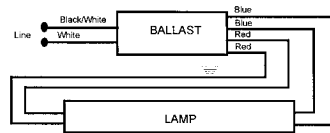
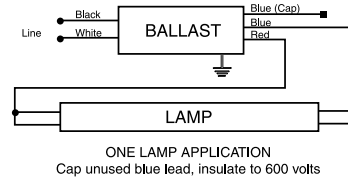
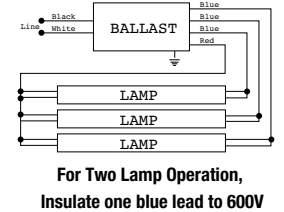

DIAGRAM 2



ONE LAMP APPLICATION
Cap unused blue lead, insulate to 600 volts

DIAGRAM 3a



For Two Lamp Operation,
Insulate one blue lead to 600V

DIAGRAM 6

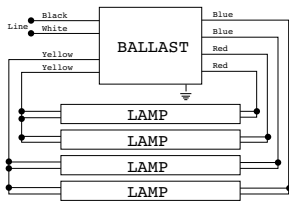

For Three Lamp Operation,
Insulate one blue lead to 600V

DIAGRAM 7

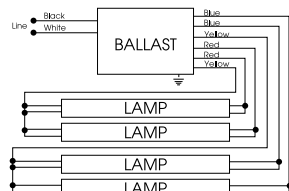

For three lamp operation, cap any
blue lead, insulate to 600V

DIAGRAM 7a

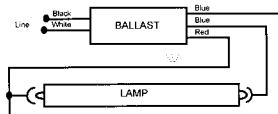
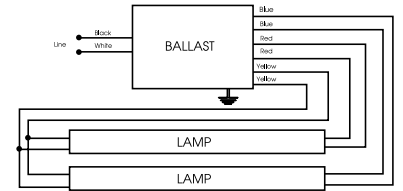

DIAGRAM 14



For one lamp operation, cap any
blue lead, insulate to 600V

DIAGRAM 30

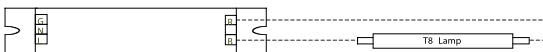

DIAGRAM 22

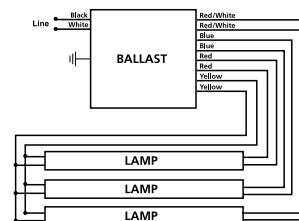
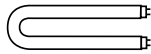
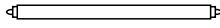

DIAGRAM 49



- Instant Starting Options
- 1-2 Lamp Applications
- 8' T8 SLIMLINE
- High Performance Models

TRIAD® ELECTRONIC BALLASTS

FOR (1) AND (2)
F48T8, F72T8, F96T8 AND F96T8ES LAMPS

Lamp		Line Volts	Catalog Number	Line Current (Amps)	Input Power (Watts)	Power Factor (PF)	Ballast Factor (BF)	Ballast Efficacy Factor (BEF)	THD %	Min. F/C Start Temp	Wiring Diag.	Dim.
Qty.	Starting Method											
F48T8 - One Lamp Applications												
1	IS	120	B244I120HE	0.30	35	> .95	1.04	2.97	< 10	0/-18	14	ST
		277	B244I277HE-A	0.14	36	> .90	1.06	2.94		0/-18	14	-A
F48T8 - Two Lamp Applications												
2	PAR-IS	120	B244I120HE	0.47	55	> .95	0.90	1.64	< 10	0/-18	14	ST
		277	B244I277HE-A	0.21	56	> .95	0.89	1.59		0/-18	14	-A
F72T8 - One Lamp Applications												
1	IS	120	B244I120HE	0.42	50	> .95	1.03	2.06	< 10	0/-18	14	ST
		277	B244I277HE-A	0.19	52	> .95	1.04	2.00		0/-18	14	-A
F72T8 - Two Lamp Applications												
2	PAR-IS	120	B244I120HE	0.70	82	> .95	0.88	1.07	< 10	0/-18	14	ST
		277	B244I277HE-A	0.30			0.87	1.06		0/-18	14	-A
F96T8 - One Lamp Applications												
1	IS	120	B259IUNVEL-A	0.54	64	> .99	0.99	1.55	< 10	32/0	15	-A
		277		0.24		> .97						
		120	B259IUNVHP-A	0.60	72	> .99	1.08	1.50	< 10	32/0	14	-A
		277		0.26	71	> .98		1.52				
		120	B259IUNVHE-A	0.60	71	> .99	1.08	1.52	< 10	32/0	15	-A
		277		0.26	70	> .97		1.54				
		120	B259IUNVEL-A	0.93	111	> .99	.88	0.79	< 10	32/0	15	-A
		277		0.39	108	> .98		0.81				
347	B259I347HP	0.20	68	> .97	1.05	1.54	< 10	32/0	14	ST		
F96T8 - Two Lamp Applications												
2	PAR-IS	120	B259IUNVEL-A	0.84	101	> .99	.78	0.77	< 10	32/0	15	-A
		277		0.36	99	> .98		0.79				
		120	B259IUNVHE-A	0.92	108	> .99	.88	0.81	< 10	60/16	15	-A
		277		0.39	107	> .99		0.82				
		120	B259IUNVHP-A	0.95	113	> .99	0.88	0.78	< 10	32/0	14	-A
		277		0.40	110	> .98		0.80				
		347	B259I347HP	0.33	113	> .99	0.89	0.79	< 10	32/0	14	ST
		F96T8ES (57W) - One Lamp Applications										
1	IS	120	B259IUNVHE-A	0.56	67	> .99	1.08	1.61	< 10	60/16	15	-A
		277		0.26	66	> .97		1.64				
		120	B259IUNVEL-A	0.51	61	> .99	0.99	1.62	< 10	60/16	15	-A
277		0.23		> .97								
F96T8ES (57W) - Two Lamp Applications												
2	PAR-IS	120	B259IUNVHE-A	0.92	108	> .99	0.88	0.81	< 10	60/16	15	-A
		277		0.39	107	> .99		0.82				
		120	B259IUNVEL-A	0.80	95	> .99	0.78	0.82	< 10	60/16	15	-A
		277		0.34	93	> .98		0.84				
F96T8ES (54W) - One Lamp Applications												
1	IS	120	B259IUNVHE-A	0.51	61	> .99	1.08	1.77	< 10	60/16	15	-A
		277		0.23	60	> .96		1.80				
F96T8ES (54W) - Two Lamp Applications												
2	PAR-IS	120	B259IUNVHE-A	0.80	95	> .99	0.88	0.93	< 10	60/16	15	-A
		277		0.34	93	> .98		0.95				
F96T8ES (49W) - One Lamp Applications												
1	IS	120	B259IUNVEL-A	0.41	48	> .99	0.99	2.06	< 10	60/16	15	-A
		277		0.19	49	> .96		2.02				
F96T8ES (49W) - Two Lamp Applications												
2	PAR-IS	120	B259IUNVEL-A	0.64	77	> .99	0.78	1.01	< 10	60/16	15	-A
		277		0.28	76	> .98		1.03				

IS = Instant Start
PS = Programmed Start

RS = Rapid Start
PAR-IS = Parallel Instant Start

STARTING METHOD LEGEND
PAR-PS = Parallel Programmed Start
SER-PS = Series Programmed Start

PAR-RS = Parallel Rapid Start
SER-RS = Series Rapid Start

SER-IS = Series Instant Start

See page 1-33 for Dimensions
and Wiring Diagrams

TRIAD® ELECTRONIC BALLASTS

FOR (1) AND (2)

F48T8HO, F60T8HO, F72T8HO AND F96T8HO LAMPS

- Instant Starting Options
- 1-2 Lamp Applications
- 4-8' T8 High Output

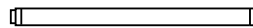

T8HO

Lamp		Line Volts	Catalog Number	Line Current (Amps)	Input Power (Watts)	Power Factor (PF)	Ballast Factor (BF)	Ballast Efficacy Factor (BEF)	THD %	Min. F/C Start Temp	Wiring Diag.	Dim.
Qty.	Starting Method											
F48T8HO - One Lamp Applications												
1	PS	120	B286PUNVHE-S	0.75	93	> .98	0.98	1.05	< 10	-20/-29	4a	-S
		277		0.34		> .95			< 12			
F48T8HO - Two Lamp Applications												
2	SER-PS	120	B286PUNVHE-S	0.41	49	> .96	1.01	2.06	< 10	-20/-29	4	-S
		277		0.19		> .92			< 15			
F96T8HO - One Lamp Applications												
1	PS	120	B286PUNVHE-S	0.80	96	> .98	1.00	1.04	< 10	-20/-29	4a	-S
		277		0.36		> .95			< 12			
F96T8HO - Two Lamp Applications												
2	SER-PS	120	B286PUNVHE-S	1.57	187	> .98	0.95	0.51	< 10	-20/-29	4	-S
		277		0.67		> .96			< 10			

Fluorescent-Electronic

STARTING METHOD LEGEND

- IS = Instant Start RS = Rapid Start PAR-PS = Parallel Programmed Start PAR-RS = Parallel Rapid Start SER-IS = Series Instant Start
 PS = Programmed Start PAR-IS = Parallel Instant Start SER-PS = Series Programmed Start SER-RS = Series Rapid Start

Overall Dimensions		Mounting Dimensions			
Draw #	L	W	H	M	X
SL	11.75"	3.13"	1.78"	11.14"	2.00"
-S	11.75"	1.70"	1.18"	11.19"	1.05"

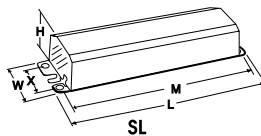

WIRING DIAGRAMS

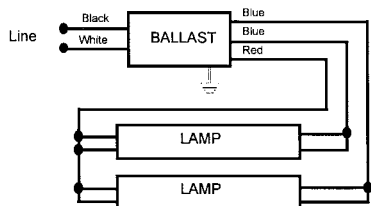

For One Lamp Operation,
Insulate one blue lead to 600V
DIAGRAM 3

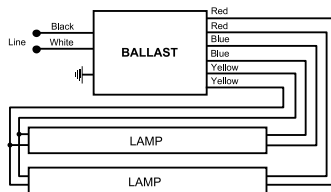

Yellow leads must be connected
to plunger end of fixture
DIAGRAM 4

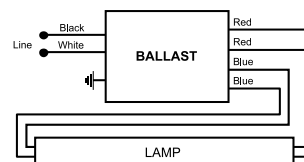

For One Lamp Applications, individually
cap yellow leads, Insulate fo 600V
DIAGRAM 4a

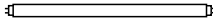

- Multiple Lamp Operation
- Rapid and Programmed Starting Options
- T5 Ballasts meet ANSI requirement for end-of-lamp life safety shutdown
- Super Low Profile Designs
- 1-2 Lamp Applications

TRIAD® T5 ELECTRONIC BALLASTS

FOR F8, F13, F14, F21 AND F24 LAMPS

Lamp		Line Volts	Catalog Number	Line Current (Amps)	Input Power (Watts)	Power Factor (PF)	Ballast Factor (BF)	Ballast Efficacy Factor (BEF)	THD %	Min. F/C Start Temp	Wiring Diag.	Dim.
Qty.	Starting Method											
F14T5 - One Lamp Applications												
1	PS	120	B114PUNV70-D	0.12	14	> .99	0.70	5.00	< 10	50/10	43	-D
		277		0.06		> .90			< 15			
		120	B228PUNV-C	0.14	17	> .98	1.05	6.17	< 10	0/-18	40	-C
		277		0.07		> .90			< 20			
		120	B228PUNV-N	0.15	17	> .98	1.02	6.17	< 10	0/-18	40	-N
		277		0.07		> .90			< 20			
		120	B228PUNV90-C	0.14	16	> .98	0.89	5.56	< 15	0/-18	37	-C
		277		0.07		> .85			< 20			
120	B228PUNV95-D	0.14	16	> .98	0.96	6.00	< 10	0/-18	40	-D		
277		0.07		> .85			< 10					
F14T5 - Two Lamp Applications												
2	SER-PS	120	B228PUNV-C	0.28	32	> .98	1.00	3.12	< 10	0/-18	37	-C
		277		0.12		> .95			< 10			
		120	B228PUNV-N	0.27	33	> .98	1.01	3.06	< 10	0/-18	37	-N
		277		0.12		> .95			< 10			
		120	B228PUNV85-D	0.24	29	> .99	0.88	3.03	< 10	0/-18	30	-D
		277		0.11		> .97			< 10			
		120	B228PUNV90-C	0.24	29	> .99	0.89	3.07	< 10	0/-18	37	-C
		277		0.11		> .90			< 15			
		120	B228PUNV95-D	0.26	31	> .99	0.95	3.06	< 10	0/-18	37	-D
		277		0.12		> .95			< 10			
120	B228PUNV115-D	0.31	37	> .99	1.15	3.12	< 10	0/-18	37	-D		
277		0.13		> .98			< 10					
F21T5 - One Lamp Applications												
1	PS	120	B128PUNV50-D	0.13	15	> .99	0.50	3.33	< 10	50/10	43	-D
		277		0.07		> .86			< 10			
		120	B128PUNV60-D	0.14	20	> .99	0.60	3.00	< 10	50/10	43	-D
		277		0.07		> .88			< 10			
		120	B128PUNV70-D	0.18	21	> .99	0.70	3.33	< 10	50/10	43	-D
		277		0.08		> .90			< 10			
		120	B228PUNV-C	0.20	24	> .98	1.03	4.29	< 10	0/-18	40	-C
		277		0.09		> .95			< 10			
		120	B228PUNV-N	0.20	24	> .98	1.01	4.21	< 10	0/-18	40	-N
		277		0.10		> .95			< 10			
		120	B228PUNV90-C	0.19	22	> .99	0.89	4.05	< 10	0/-18	37	-C
		277		0.09		> .90			< 15			
		120	B228PUNV95-D	0.20	24	> .99	0.96	4.00	< 10	0/-18	40	-D
		277		0.09		> .90			< 10			
F21T5 - Two Lamp Applications												
2	SER-PS	120	B228PUNV-C	0.41	48	> .98	1.00	2.08	< 10	0/-18	37	-C
		277		0.17		> .98			< 10			
		120	B228PUNV-N	0.39	47	> .98	1.00	2.13	< 10	0/-18	37	-N
		277		0.17		> .98			< 10			
		120	B228PUNV85-D	0.35	41	> .99	0.86	2.10	< 10	0/-18	30	-D
		277		0.15		> .98			< 10			
		120	B228PUNV90-C	0.35	42	> .99	0.89	2.12	< 10	0/-18	37	-C
		277		0.16		> .95			< 10			
		120	B228PUNV95-D	0.40	47	> .99	0.95	2.02	< 10	0/-18	37	-D
		277		0.17		> .95			< 10			
120	B228PUNV115-D	0.44	52	> .99	1.15	2.21	< 10	0/-18	37	-D		
277		0.19		> .98			< 10					

See page 1-41 for Dimensions and Wiring Diagrams

IS = Instant Start
PS = Programmed Start

RS = Rapid Start
PAR-IS = Parallel Instant Start

STARTING METHOD LEGEND
PAR-PS = Parallel Programmed Start
SER-PS = Series Programmed Start

PAR-RS = Parallel Rapid Start
SER-RS = Series Rapid Start

SER-IS = Series Instant Start

TRIAD® T5 ELECTRONIC BALLASTS

FOR F28 AND F35T5 LAMPS

- Multiple Lamp Operation
- Rapid and Programmed Rapid Starting Options
- T5 Ballasts meet ANSI requirement for end-of-lamp life safety shutdown
- Super Low Profile Designs
- 1-2 Lamp Applications

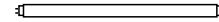

T5

Fluorescent-Electronic

Lamp		Line Volts	Catalog Number	Line Current (Amps)	Input Power (Watts)	Power Factor (PF)	Ballast Factor (BF)	Ballast Efficacy Factor (BEF)	THD %	Min. F/C Start Temp	Wiring Diag.	Dim.
Qty.	Starting Method											
F28T5 - One Lamp Applications												
1	PS	120	B128PUNV50-D	0.17	20	> .99	0.50	2.50	< 10	50/10	43	-D
		277		0.08		> .90			< 12			
		120	B128PUNV60-D	0.18	22	> .99	0.60	2.73	< 10	50/10	43	-D
		277		0.09		> .92						
		120	B128PUNV70-D	0.21	25	> .99	0.70	2.80	< 10	50/10	43	-D
		277		0.11		> .93						
		120	B228PUNV-C	0.27	32	> .98	1.00	3.12	< 10	0/-18	40	-C
		277		0.12		> .95						
		120	B228PUNV-N	0.27	32	> .98	1.00	3.12	< 10	0/-18	40	-N
		277		0.12		> .95						
		120	B228PUNV85-D	0.25	30	> .99	0.88	2.93	< 10	0/-18	40	-D
		277		0.11		> .98						
		120	B228PUNV90-C	0.25	29	> .99	0.90	3.10	< 10	0/-18	37	-C
		277		0.11		> .90						
		120	B228PUNV95-D	0.25	30	> .99	0.96	3.20	< 10	0/-18	40	-D
		277		0.11		> .95						
F28T5 - Two Lamp Applications												
2	SER-PS	120	B228PUNV-C	0.55	63	> .98	1.00	1.59	< 10	0/-18	37	-C
		277		0.23		61						
		120	B228PUNV-N	0.54	65	> .98	1.00	1.54	< 10	0/-18	37	-N
		277		0.23		64						
		120	B228PUNV85-D	0.48	54	> .99	0.85	1.57	< 10	0/-18	30	-D
		277		0.21		53						
		120	B228PUNV90-C	0.48	58	> .98	0.90	1.55	< 10	0/-18	37	-C
		277		0.21		56						
		120	B228PUNV95-D	0.51	61	> .99	0.95	1.56	< 10	0/-18	37	-D
		277		0.22		60						
120	B228PUNV115-D	0.59	69	> .99	1.15	1.67	< 10	0/-18	37	-D		
277		0.25		68							> .98	1.69
F28T5ES (26W) - One Lamp Applications												
1	PS	120	B228PUNV95-D	0.24	29	> .99	0.96	3.31	< 10	0/-18	40	-D
		277		0.11								
F28T5ES (26W) - Two Lamp Applications												
2	SER-PS	120	B228PUNV95-D	0.48	57	> .99	0.95	1.67	< 10	0/-18	37	-D
		277		0.21		56						
F28T5ES (25W) - One Lamp Applications												
1	PS	120	B228PUNV-N	0.24	29	> .98	1.00	3.45	< 10	0/-18	40	-N
		277		0.11		> .95						
		120	B228PUNV95-D	0.23	28	> .99	0.96	3.43	< 10	0/-18	40	-D
		277		0.11		> .95						
F28T5ES (25W) - Two Lamp Applications												
2	SER-PS	120	B228PUNV-N	0.49	59	> .98	1.00	1.69	< 10	0/-18	37	-N
		277		0.21		58						
		120	B228PUNV95-D	0.47	56	> .99	0.95	1.70	< 10	0/-18	37	-D
		277		0.20		54						
F35T5 - One Lamp Applications												
1	PS	120	B135PUNV70-D	0.25	30	> .99	0.70	2.33	< 10	50/10	43	-D
		277		0.12		> .95						
		120	B228PUNV95-D	0.32	38	> .99	0.95	2.50	< 10	0/-18	40	-D
		277		0.14		> .97						
		120	B228PUNV-C	0.33	40	> .99	1.00	2.50	< 10	0/-18	40	-C
		277		0.15		> .97						
		120	B228PUNV-N	0.33	40	> .99	1.00	2.50	< 10	0/-18	40	-N
		277		0.15		> .95						

See page 1-41 for Dimensions and Wiring Diagrams

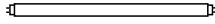

- Multiple Lamp Operation
- Programmed Rapid and Instant Starting Models
- T5HO Ballasts meet ANSI requirements for end-of-lamp life safety shutdown
- Super Low Profile Designs
- 1-4 Lamp Applications

TRIAD® T5HO ELECTRONIC BALLASTS

FOR F24, F39 AND F54 T5HO LAMPS

Lamp		Line Volts	Catalog Number	Line Current (Amps)	Input Power (Watts)	Power Factor (PF)	Ballast Factor (BF)	Ballast Efficacy Factor (BEF)	THD %	Min. F/C Start Temp	Wiring Diag.	Dim.
Qty.	Starting Method											
F24T5HO - One Lamp Applications												
1	PS	120 277	B224PUNV-C	0.23 0.10	28	> .98 > .95	1.06	3.79	< 10	0/-18	40	-C
F24T5HO - Two Lamp Applications												
2	SER-PS	120 277	B224PUNV-C	0.45 0.19	53 52	> .98	1.00	1.89 1.92	< 10	0/-18	37	-C
		120 277	B239PUNV-D	0.51 0.22	59	> .98 > .95	1.15	1.95	< 10	0/-18	37	-D
F39T5HO - One Lamp Applications												
1	PS	120 277	B224PUNV-C	0.34 0.15	41 40	> .98	0.95	2.32 2.38	< 10	0/-18	40	-C
		120 277	B239PUNV-D	0.39 0.18	47	> .98 > .95	1.10	2.34	< 10	0/-18	40	-D
F39T5HO - Two Lamp Applications												
2	SER-PS	120 277	B239PUNV-D	0.75 0.32	89 88	> .98	1.00	1.12 1.14	< 10	0/-18	37	-D
F54T5HO - One Lamp Applications												
1	PS	347	B254P347-D	0.19	64	> .95	1.02	1.59	< 10	-20/-29	37	-D
		347	B254PHRVHB-E	0.19	66	> .98	1.02	1.55	< 10	-20/-29	42	-E
		480	B254PHRVHB-E	0.15	66	> .90	1.02	1.55	< 15	-20/-29	42	-E
		120 277	B254PUNV-D	0.49 0.22	59	> .99 > .96	1.00	1.69	< 10	-20/-29	40	-D
		120 277	B254PUNVHB-D	0.49 0.22	59	> .99 > .96	1.00	1.69	< 10	-20/-29	40	-D
		120 277	B254PUNVPL-A	0.50 0.23	60 59	> .99 > .94	1.00 1.02	1.67 1.71	< 10	-20/-29	A	-A
		120 277	B254PUNVPLHBA	0.50 0.23	60 59	> .99 > .94	1.00 1.02	1.67 1.71	< 10	-20/-29	A	-A
		120 277	B454PUNV-E	0.54 0.26	65	> .95 > .90	1.05	1.62	< 15 < 20	-20/-29	44	-E
		120 277	B454PUNVHB-E	0.54 0.26	65	> .95 > .90	1.05	1.62	< 15 < 20	-20/-29	44	-E
		F54T5HO - Two Lamp Applications										
2	SER-PS	347 480	B254PHRVHB-E	0.35 0.26	120 119	> .98 > .95	1.00	0.83 0.84	< 10	-20/-29	41	-E
		120 277	B254PUNV-D	0.96 0.41	116 113	> .99 > .98	1.00	0.86 0.88	< 10	-20/-29	37	-D
		120 277	B254PUNVHB-D	0.96 0.41	116 113	> .99 > .98	1.00	0.86 0.88	< 10	-20/-29	37	-D
		347	B254P347-D	0.35	120	> .98	1.00	0.83	< 10	-20/-29	37	-D
		120 277	B454PUNV-E	1.01 0.44	122 121	> .95	1.00	0.82 0.83	< 10 < 15	-20/-29	44	-E
		120 277	B454PUNVHB-E	1.01 0.44	122 121	> .95	1.00	0.82 0.83	< 10 < 15	-20/-29	44	-E
		120 277	B254PUNVPL-A	0.94 0.40	113 110	> .99 > .98	0.96 0.99	0.85 0.90	< 10	-20/-29	A	-A
		120 277	B254PUNVPLHBA	0.94 0.40	113 110	> .99 > .98	0.96 0.99	0.85 0.90	< 10	-20/-29	A	-A
F54T5HO - Three Lamp Applications												
3	SER-PS	120 277	B454PUNV-E	1.52 0.66	184 182	> .98 > .95	1.05	0.57 0.58	< 10	-20/-29	44	-E
		120 277	B454PUNVHB-E	1.52 0.66	184 182	> .98 > .95	1.05	0.57 0.58	< 10	-20/-29	44	-E
3	PAR-PS	120 277	B454PUNVPL-E	1.34 0.58	159 157	> .99 > .97	0.90	0.57	< 10	-20/-29	B	-E
		120 277	B454PUNVPLHBE	1.34 0.58	159 157	> .99 > .97	0.90	0.57	< 10	-20/-29	B	-E

See page 1-41 for Dimensions and Wiring Diagrams

TRIAD® T5HO ELECTRONIC BALLASTS

FOR F24, F39 AND F54 T5HO LAMPS

- Multiple Lamp Operation
- Programmed Rapid and Instant Starting Models
- T5HO Ballasts meet ANSI requirements for end-of-lamp life safety shutdown
- Super Low Profile Designs
- 1-4 Lamp Applications

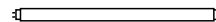

T5HO

Fluorescent-Electronic

Lamp		Line Volts	Catalog Number	Line Current (Amps)	Input Power (Watts)	Power Factor (PF)	Ballast Factor (BF)	Ballast Efficacy Factor (BEF)	THD %	Min. F/C Start Temp	Wiring Diag.	Dim.
Qty.	Starting Method											
F54T5HO - Four Lamp Applications												
4	SER-PS	120	B454PUNV-E	1.96	235	> .98	1.00	0.43	< 10	-20/-29	44	-E
		277		0.84	229	> .99		0.44				
4	PAR-PS	120	B454PUNVHB-E	1.96	235	> .98	1.00	0.43	< 10	-20/-29	44	-E
		277		0.84	229	> .99		0.44				
4	PAR-PS	120	B454PUNVPLHBE	1.77	210	> .99	0.90	0.43	< 10	-20/-29	B	-E
		277		0.76	207	> .98		0.43				
F54T5HOES (51W) - One Lamp Applications												
1	PS	120	B254PUNV-D	0.46	55	> .99	1.00	1.82	< 10	60/16	40	-D
		277		0.20	55	> .96		1.82				
1	PS	120	B254PUNVPL-A	0.46	55	> .99	1.00	1.81	< 10	60/16	A	-A
		277		0.21	55	> .93		1.83				
1	PS	120	B254PUNVPLHBA	0.46	55	> .99	1.00	1.81	< 10	60/16	A	-A
		277		0.21	55	> .93		1.83				
F54T5HOES (51W) - Two Lamp Applications												
2	SER-PS	120	B254PUNV-D	0.89	107	> .99	1.00	0.93	< 10	60/16	37	-D
		277		0.37	103	> .98		0.97				
2	PAR-PS	120	B254PUNVPL-A	0.90	104	> .99	0.96	0.92	< 10	60/16	A	-A
		277		0.39	101	> .97		0.95				
2	PAR-PS	120	B254PUNVPLHBA	0.90	104	> .99	0.96	0.92	< 10	60/16	A	-A
		277		0.39	101	> .97		0.95				
F54T5HOES (51W) - Three Lamp Applications												
3	PAR-PS	120	B454PUNVPL-E	1.27	151	> .99	0.90	0.60	< 10	60/16	B	-E
		277		0.55	148	> .97		0.61				
3	PAR-PS	120	B454PUNVPLHBE	1.27	151	> .99	0.90	0.60	< 10	60/16	B	-E
		277		0.55	148	> .97		0.61				
F54T5HOES (51W) - Four Lamp Applications												
4	PAR-PS	120	B454PUNVPL-E	1.65	196	> .99	0.90	0.46	< 10	60/16	B	-E
		277		0.71	192	> .97		0.47				
4	PAR-PS	120	B454PUNVPLHBE	1.65	196	> .99	0.90	0.46	< 10	60/16	B	-E
		277		0.71	192	> .97		0.47				
F54T5HOES (50W) - One Lamp Applications												
1	PS	120	B254PUNVPL-A	0.47	56	> .99	1.00	1.79	< 10	60/16	A	-A
		277		0.21	55	> .92		0.99				
1	PS	120	B254PUNVPLHBA	0.47	56	> .99	1.00	1.79	< 10	60/16	A	-A
		277		0.21	55	> .92		0.99				
F54T5HOES (50W) - Two Lamp Applications												
2	PAR-PS	120	B254PUNVPL-A	0.92	106	> .99	0.96	0.90	< 10	60/16	A	-A
		277		0.40	103	> .97		0.93				
2	PAR-PS	120	B254PUNVPLHBA	0.92	106	> .99	0.96	0.90	< 10	60/16	A	-A
		277		0.40	103	> .97		0.93				
F54T5HOES (50W) - Three Lamp Applications												
3	PAR-PS	120	B454PUNVPL-E	1.30	154	> .99	0.90	0.58	< 10	60/16	B	-E
		277		0.56	151	> .97		0.60				
3	PAR-PS	120	B454PUNVPLHBE	1.30	154	> .99	0.90	0.58	< 10	60/16	B	-E
		277		0.56	151	> .97		0.60				
F54T5HOES (50W) - Four Lamp Applications												
4	PAR-PS	120	B454PUNVPL-E	1.67	198	> .99	0.90	0.45	< 10	60/16	B	-E
		277		0.72	194	> .98		0.46				
4	PAR-PS	120	B454PUNVPLHBE	1.67	198	> .99	0.90	0.45	< 10	60/16	B	-E
		277		0.72	194	> .98		0.46				
F54T5HOES (49W) - One Lamp Applications												
1	PS	120	B254PUNV-D	0.44	54	> .99	1.00	1.85	< 10	60/16	40	-D
		277		0.20	53	> .96		1.89				
1	PS	120	B254PUNVHB-D	0.44	54	> .99	1.00	1.85	< 10	60/16	40	-D
		277		0.20	53	> .96		1.89				
1	PS	120	B254PUNVPL-A	0.45	54	> .99	1.00	1.85	< 10	60/16	A	-A
		277		0.21	53	> .92		1.89				
1	PS	120	B254PUNVPLHBA	0.45	54	> .99	1.00	1.85	< 10	60/16	A	-A
		277		0.21	53	> .92		1.89				



- Multiple Lamp Operation
- Programmed Rapid and Instant Starting Models
- T5HO Ballasts meet ANSI requirements for end-of-lamp life safety shutdown
- Super Low Profile Designs
- 1-4 Lamp Applications

TRIAD® T5HO ELECTRONIC BALLASTS

FOR F24, F39 AND F54 T5HO LAMPS

Lamp		Line Volts	Catalog Number	Line Current (Amps)	Input Power (Watts)	Power Factor (PF)	Ballast Factor (BF)	Ballast Efficacy Factor (BEF)	THD %	Min. F/C Start Temp	Wiring Diag.	Dim.
Qty.	Starting Method											
F54T5HOES (49W) - Two Lamp Applications												
2	SER-PS	120	B254PUNV-D	0.87	105	> .99	1.00	0.95	< 10	60/16	37	-D
		277		0.37	102	> .98		0.98				
2	PAR-PS	120	B254PUNVHB-D	0.87	105	> .99	1.00	0.95	< 10	60/16	37	-D
		277		0.37	102	> .98		0.98				
2	PAR-PS	120	B254PUNVPL-A	0.86	103	> .99	0.97	0.94	< 10	60/16	A	-A
		277		0.37	101	> .97		0.96				
2	PAR-PS	120	B254PUNVPLHBA	0.86	103	> .99	0.97	0.94	< 10	60/16	A	-A
		277		0.37	101	> .97		0.96				
F54T5HOES (49W) - Three Lamp Applications												
3	PAR-PS	120	B454PUNVPL-E	1.19	142	> .99	0.90	0.63	< 10	60/16	B	-E
		277		0.52	140	> .96		0.64				
3	PAR-PS	120	B454PUNVPLHBE	1.19	142	> .99	0.90	0.63	< 10	60/16	B	-E
		277		0.52	140	> .96		0.64				
F54T5HOES (49W) - Four Lamp Applications												
4	PAR-PS	120	B454PUNVPL-E	1.61	192	> .99	0.90	0.47	< 10	60/16	B	-E
		277		0.69	188	> .98		0.48				
4	PAR-PS	120	B454PUNVPLHBE	1.61	192	> .99	0.90	0.47	< 10	60/16	B	-E
		277		0.69	188	> .98		0.48				
F54T5HOES (47W) - One Lamp Applications												
1	PS	120	B254PUNV-D	0.42	54	> .99	1.00	1.85	< 10	60/16	40	-D
		277		0.20	53	> .95		1.89				
1	PS	120	B254PUNVPL-A	0.45	54	> .99	1.00	1.86	< 10	60/16	A	-A
		277		0.21	53	> .92		1.87				
1	PS	120	B254PUNVPLHBA	0.45	54	> .99	1.00	1.86	< 10	60/16	A	-A
		277		0.21	53	> .92		1.87				
F54T5HOES (47W) - Two Lamp Applications												
2	PAR-PS	120	B254PUNV-D	0.85	102	> .99	1.00	0.98	< 10	60/16	37	-D
		277		0.36	99	> .98		1.01				
2	PAR-PS	120	B254PUNVPL-A	0.86	100	> .99	0.96	0.96	< 10	60/16	A	-A
		277		0.37	98	> .97		0.96				
2	PAR-PS	120	B254PUNVPLHBA	0.86	100	> .99	0.96	0.96	< 10	60/16	A	-A
		277		0.37	98	> .97		0.96				
F54T5HOES (47W) - Three Lamp Applications												
3	PAR-PS	120	B454PUNVPL-E	1.21	144	> .99	0.90	0.63	< 10	60/16	B	-E
		277		0.53	142	> .96		0.63				
3	PAR-PS	120	B454PUNVPLHBE	1.21	144	> .99	0.90	0.63	< 10	60/16	B	-E
		277		0.53	142	> .96		0.63				
F54T5HOES (47W) - Four Lamp Applications												
4	PAR-PS	120	B454PUNVPL-E	1.59	189	> .99	0.90	0.48	< 10	60/16	B	-E
		277		0.68	185	> .97		0.49				
4	PAR-PS	120	B454PUNVPLHBE	1.59	189	> .99	0.90	0.48	< 10	60/16	B	-E
		277		0.68	185	> .97		0.49				

See page 1-41 for Dimensions and Wiring Diagrams

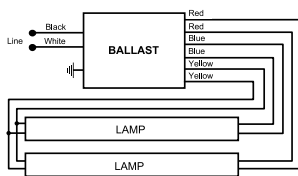

For one lamp operation, cap blue leads individually, insulate to 600V.

DIAGRAM A

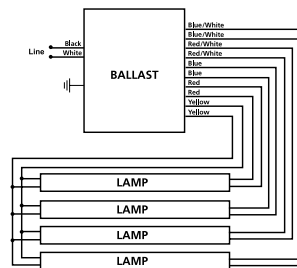

For three lamp operation, cap Blue/White leads individually, insulate to 600V.

DIAGRAM B

TRIAD® T5 & T5HO ELECTRONIC BALLASTS

T5 & T5HO

Fluorescent-Electronic

Lamp		Line Volts	Catalog Number	Line Current (Amps)	Input Power (Watts)	Power Factor (PF)	Ballast Factor (BF)	Ballast Efficacy Factor (BEF)	THD %	Min. F/C Start Temp	Wiring Diag.	Dim.
Qty.	Starting Method											
F54T5HOES (44W) - One Lamp Applications												
1	PS	120	B254PUNVPL-A	0.43	51	> .99	1.00	1.95	< 10	60/16	A	-A
		277		0.20		> .92		1.96				
		120	B254PUNVPLHBA	0.43	51	> .99	1.00	1.95	< 10	60/16	A	-A
		277		0.20		> .92		1.96				
F54T5HOES (44W) - Two Lamp Applications												
2	PAR-PS	120	B254PUNVPL-A	0.81	97	> .99	0.93	0.96	< 10	60/16	A	-A
		277		0.35		> .97		0.98				
		120	B254PUNVPLHBA	0.81	97	> .99	0.93	0.96	< 10	60/16	A	-A
		277		0.35		> .97		0.98				
F54T5HOES (44W) - Three Lamp Applications												
3	PAR-PS	120	B454PUNVPL-E	1.10	131	> .99	0.92	0.70	< 10	60/16	B	-E
		277		0.49		> .96		0.71				
		120	B454PUNVPLHBE	1.10	131	> .99	0.92	0.70	< 10	60/16	B	-E
		277		0.49		> .96		0.71				
F54T5HOES (44W) - Four Lamp Applications												
4	PAR-PS	120	B454PUNVPL-E	1.46	174	> .99	0.92	0.53	< 10	60/16	B	-E
		277		0.63		> .97		0.54				
		120	B454PUNVPLHBE	1.46	174	> .99	0.92	0.53	< 10	60/16	B	-E
		277		0.63		> .97		0.54				

Overall Dimensions		Mounting Dimensions			
Draw #	L	W	H	M	X
-C	14.25"	1.18"	1.00"	13.75"	—
-D	16.88"	1.18"	1.00"	16.20"	—
-E	16.88"	1.74"	1.18"	16.28"	—

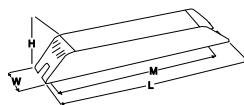

-C, -D

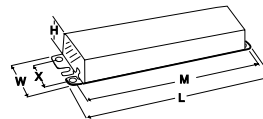

-E

WIRING DIAGRAMS



DIAGRAM 4b

FOR ONE LAMP OPERATION
CAP YELLOW LEADS INDIVIDUALLY

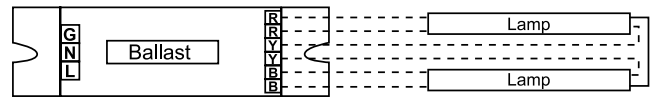

DIAGRAM 37

FOR ONE LAMP OPERATION, CAP YELLOW LEADS INDIVIDUALLY

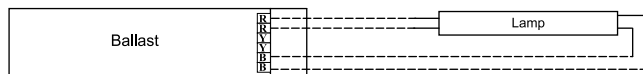

DIAGRAM 40

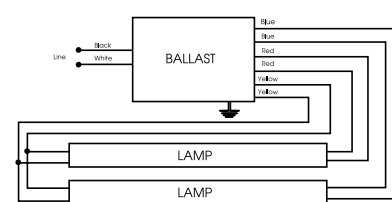

DIAGRAM 30

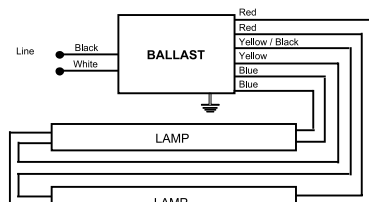
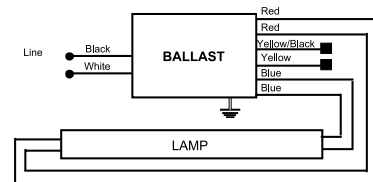

DIAGRAM 41



For one lamp operation, individually cap yellow and yellow/black leads, insulate to 600V.

DIAGRAM 42

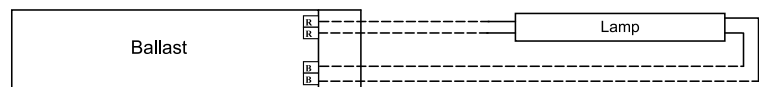
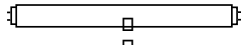

DIAGRAM 43

F30T12, F30T12ES, F32T12



- Rapid Starting Options
- Standard & High Performance Models
- 1-3 Lamp Applications

TRIAD® ELECTRONIC BALLASTS

FOR (1), (2) AND (3)
F30T12, F30T12ES, & (2)F32T12 LAMPS

Lamp		Line Volts	Catalog Number	Line Current (Amps)	Input Power (Watts)	Power Factor (PF)	Ballast Factor (BF)	Ballast Efficacy Factor (BEF)	THD %	Min. F/C Start Temp	Wiring Diag.	Dim.
Qty.	Starting Method											
F25T12 - Two Lamp Applications												
2	PAR-IS	120	B232IUNV-C	0.40	47	> .98	0.89	1.89	< 10	0/-18	21	-C
		277		0.17	46			1.93				
F25T12 - Three Lamp Applications												
3	PAR-IS	120	B332IUNVHP-A	0.58	69	> .99	0.90	1.30	< 10	0/-18	6	-A
		277		0.26	68	> .95	0.91	1.34				
F25T12 - Four Lamp Applications												
4	PAR-IS	120	B432IUNVHP-A	0.77	91	> .99	0.90	0.99	< 10	0/-18	7a	-A
		277		0.34	88	> .95		1.02				
F32T12 - One Lamp Applications												
1	RS	277	B234SR277M-A*	0.15	33	> .80	0.94	2.85	< 30	50/10	4	-A
F32T12 - Two Lamp Applications												
2	SER-RS	120	B234SR120M-A ^Δ	0.46	54	> .98	0.90	1.67	< 10	50/10	30	-A
		277	B234SR277M-A*	0.21	55	> .90	0.87	1.58	< 30	50/10	4	-A

^Δ Residential use only.

*Not for sale for use in the US.

Overall Dimensions		Mounting Dimensions				
Draw #	L	W	H	M	X	
ST	9.50"	2.40"	1.55"	8.89"	1.69"	
-A	9.50"	1.70"	1.18"	8.89"	1.69"	

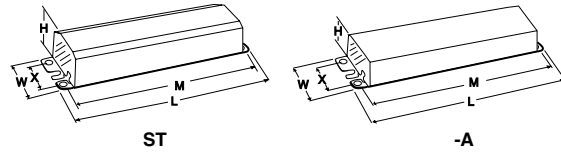

WIRING DIAGRAMS

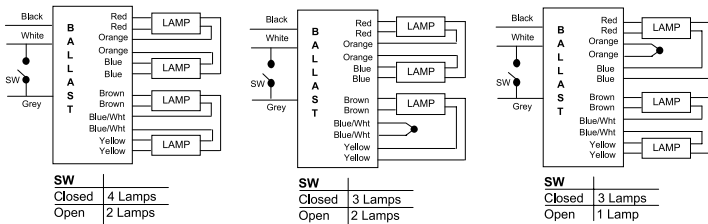

Application Notes:

- 'SW' controls the lamps connected between the Brown and Yellow leads
- For lamp switching applications, connect 'SW' between the white and the grey leads as shown in the wiring diagram above OR between the Black and Grey leads. The switch "SW" may be an on-off switch, an occupancy sensor, a relay, etc.
- If lamp switching is not required, short the white and grey leads OR the black and the grey leads
- A single control device, "SW", may be connected to control multiple ballasts
- For three lamp use: Short Blue/White leads or Orange leads and cap

DIAGRAM 44

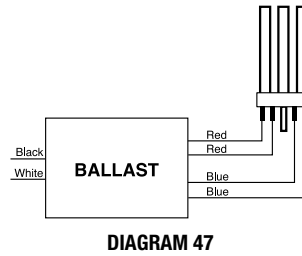

DIAGRAM 47

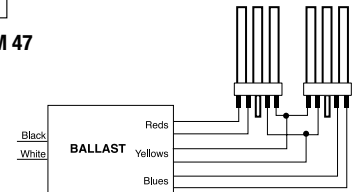
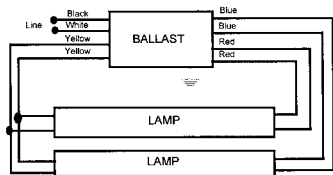
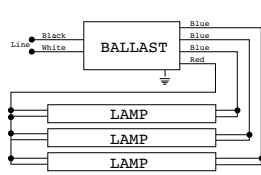

DIAGRAM 48



For One lamp Operation, Individually Cap blue leads, Insulate to 600V

DIAGRAM 4



For Two Lamp Operation, Insulate one blue lead to 600V

DIAGRAM 6

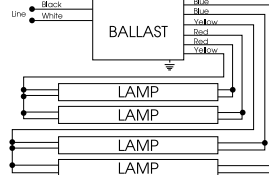

For three lamp operation, cap any blue lead, insulate to 600V

DIAGRAM 7a

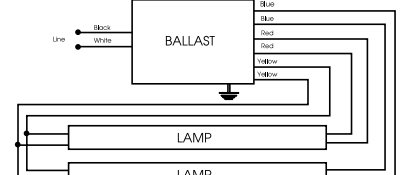

DIAGRAM 30

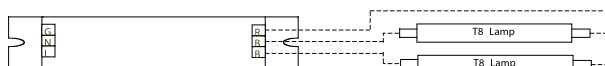
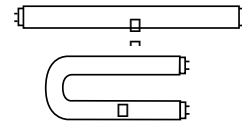

DIAGRAM 21

TRIAD® ELECTRONIC BALLASTS

FOR (1) , (2) AND (3) F40T12 AND F34T12ES LAMPS

- Standard & High Performance Models
- Rapid Starting Options
- 1-3 Lamp Applications



F40T12 & F34T12ES

Lamp		Line Volts	Catalog Number	Line Current (Amps)	Input Power (Watts)	Power Factor (PF)	Ballast Factor (BF)	Ballast Efficacy Factor (BEF)	THD %	Min. F/C Start Temp	Wiring Diag.	Dim.
Qty.	Starting Method											
F40T12 - One Lamp Applications												
1	RS	220	B240R220-A*	0.20	44	> .99	1.04	2.38	< 10	50/10	4	-A
		277	B234SR277M-A*	0.17	42	> .88	0.94	2.24	< 30	50/10	4	-A
F40T12 - Two Lamp Applications												
2	SER-RS	120	B234SR120M-A ^Δ	0.58	69	> .98	0.90	1.30	< 10	50/10	30	-A
		277	B234SR277M-A*	0.26	70	> .90	0.87	1.24	< 30	50/10	4	-A
2	PAR-RS	220	B240R200-A*	0.32	70	> .99	0.90	1.29	< 10	50/10	4	-A
F40T12ES (34W) - One Lamp Applications												
1	RS	220	B240R200-A*	0.17	36	> .99	1.04	2.86	< 10	60/16	4	-A
		277	B234SR277M-A*	0.15	35	> .80	0.94	2.69	< 30	60/16	4	-A
F40T12ES (34W) - Two Lamp Applications												
2	SER-RS	120	B234SR120M-A ^Δ	0.48	58	> .98	0.86	1.48	< 10	60/16	30	-A
		277	B234SR277M-A*	0.23	60	> .90	0.87	1.45	< 30	50/10	4	-A
2	PAR-RS	220	B240R200-A*	0.27	59	> .99	0.90	1.52	< 10	60/16	4	-A

^Δ Residential use only.

* Not for sale for use in the US.

Draw #	Overall Dimensions		Mounting Dimensions		
	L	W	H	M	X
-A	9.50"	1.70"	1.18"	8.89"	1.69"

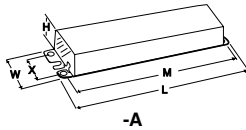

WIRING DIAGRAMS

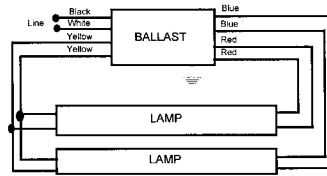

For One Lamp Applications, individually cap blue leads, Insulate to 600V

DIAGRAM 4

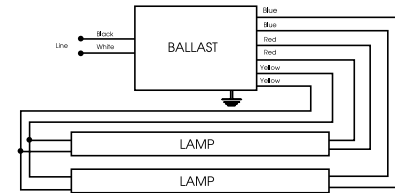
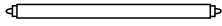

DIAGRAM 30

Fluorescent-Electronic

T12 SLIMLINE



- Standard & High Performance Models
- Instant Starting Options
- 1-2 Lamp Applications

TRIAD® ELECTRONIC BALLASTS FOR F48T12, F48T12ES, F60T12, F64T12 & F72T12 LAMPS

Lamp		Line Volts	Catalog Number	Line Current (Amps)	Input Power (Watts)	Power Factor (PF)	Ballast Factor (BF)	Ballast Efficacy Factor (BEF)	THD %	Min. F/C Start Temp	Wiring Diag.	Dim.
Qty.	Starting Method											
F48T12 - One Lamp Applications												
1	IS	120	B260IUNVHP	0.39	47	> .95	1.10	2.34	< 10	0/-18	14	SL
		277		0.18								
F48T12 - Two Lamp Applications												
2	PAR-IS	120	B260I120M-A*	0.62	68	> .90	0.90	1.32	< 30	50/10	14	-A
		120	B260IUNVHP	0.61	75	> .98	0.95	1.27	< 10	0/-18	14	SL
		277		0.27	74	> .95		1.28				
F48T12ES - One Lamp Applications												
1	IS	120	B260IUNVHP	0.32	38	> .98	1.10	2.89	< 10	60/16	14	SL
		277		0.15	39	> .95		2.82				
F48T12ES - Two Lamp Applications												
2	PAR-IS	120	B260IUNVHP	0.57	67	> .95	0.93	1.39	< 10	60/16	14	SL
		277		0.25	66	> .95		1.41				
F60T12 - One Lamp Applications												
1	IS	120	B260IUNVHP	0.49	58	> .98	1.10	1.90	< 10	0/-18	14	SL
		277		0.22	58	> .95		1.90				
F60T12 - Two Lamp Applications												
2	PAR-IS	120	B260IUNVHP	0.77	92	> .98	0.92	1.00	< 10	0/-18	14	SL
		277		0.33	91	> .98		1.01				
F64T12 - One Lamp Applications												
1	IS	120	B260IUNVHP	0.51	61	> .98	1.10	1.80	< 10	0/-18	14	SL
		277		0.35	96	> .95		1.15				
F64T12 - Two Lamp Applications												
2	PAR-IS	120	B260IUNVHP	0.81	97	> .98	0.92	0.95	< 10	0/-18	14	SL
		277		0.35	96	> .98		0.96				
F72T12 - One Lamp Applications												
1	IS	120	B260IUNVHP	0.55	68	> .95	1.06	1.56	< 10	0/-18	14	SL
		277		0.25	67	> .95		1.58				

* Residential use only.

Overall Dimensions			Mounting Dimensions		
Draw #	L	W	H	M	X
SL	11.75"	3.13"	1.78"	11.14"	2.00"
-A	9.50"	1.70"	1.18"	8.89"	1.69"

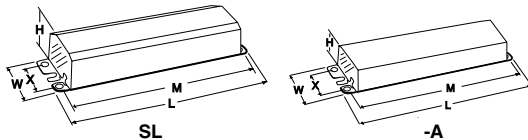

WIRING DIAGRAMS

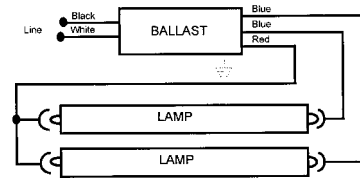

For One Lamp Operation, Insulate one blue lead to 600V

DIAGRAM 14

TRIAD® ELECTRONIC BALLASTS

F72T12(cont.), F84T12, F96T12 & F96T12ES LAMPS

- Standard & High Performance Models
- Instant Starting Options
- 1-2 Lamp Applications

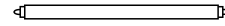

**T12
SLIMLINE**

Fluorescent-Electronic

Lamp		Line Volts	Catalog Number	Line Current (Amps)	Input Power (Watts)	Power Factor (PF)	Ballast Factor (BF)	Ballast Efficacy Factor (BEF)	THD %	Min. F/C Start Temp	Wiring Diag.	Dim.
Qty.	Starting Method											
F72T12 - Two Lamp Applications												
2	PAR-IS	120	B260I120M-A*	0.90	105	> .95	0.90	0.86	< 30	50/10	14	-A
		120	B260IUNVHP	0.90	109	> .99	0.91	0.85	< 10	0/-18	14	SL
		277		0.39	107							
F84T12 - One Lamp Applications												
1	IS	120	B260IUNVHP	0.63	76	> .98	1.10	1.45	< 10	0/-18	14	SL
		277		0.28	75			1.47				
F84T12 - Two Lamp Applications												
2	PAR-IS	120	B260IUNVHP	1.03	123	> .98	0.88	0.72	< 10	0/-18	14	SL
		277		0.44	120			0.73				
F96T12 - One Lamp Applications												
1	IS	120	B260IUNVHP	0.70	85	> .98	1.05	1.24	< 10	0/-18	14	SL
		277		0.31	84			1.25				
F96T12 - Two Lamp Applications												
2	PAR-IS	120	B260IUNVHP	1.16	139	> .99	0.88	0.63	< 10	0/-18	14	SL
		277		0.50	137			0.64				
F96T12ES - One Lamp Applications												
1	IS	120	B260I120M-A*	0.61	66	> .90	1.09	1.65	< 30	60/16	14	-A
		120	B260IUNVHP	0.59	72	> .98	1.03	1.43	< 10	60/16	14	SL
		277		0.26	70			1.47				
F96T12ES - Two Lamp Applications												
2	PAR-IS	120	B260I120M-A*	0.90	105	> .95	0.88	0.84	< 30	60/16	14	-A
		120	B260IUNVHP	0.96	112	> .99	0.88	0.79	< 10	60/16	14	SL
		277		0.40	110			0.80				

* Residential use only.

STARTING METHOD LEGEND

IS = Instant Start RS = Rapid Start PAR-PRS = Parallel Programmed Rapid Start PAR-RS = Parallel Rapid Start SER-IS = Series Instant Start
 PRS = Programmed Rapid Start PAR-IS = Parallel Instant Start SER-PRS = Series Programmed Rapid Start SER-RS = Series Rapid Start

Overall Dimensions		Mounting Dimensions			
Draw #	L	W	H	M	X
SL	11.75"	3.13"	1.78"	11.14"	2.00"
-A	9.50"	1.70"	1.18"	8.89"	1.69"

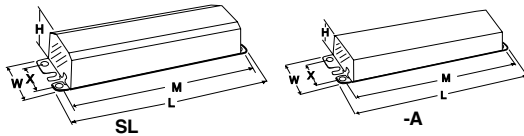

WIRING DIAGRAMS

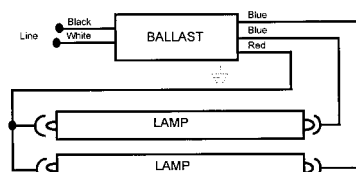

For One Lamp Operation, Insulate one blue lead to 600V

DIAGRAM 14

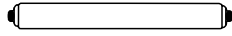

- High Performance Models
- Rapid Starting Options
- 2 Lamp Applications

TRIAD® ELECTRONIC BALLASTS

FOR T12 HIGH OUTPUT LAMPS

Lamp Qty.	Starting Method	Line Volts	Catalog Number	Line Current (Amps)	Input Power (Watts)	Power Factor (PF)	Ballast Factor (BF)	Ballast Efficacy Factor (BEF)	THD %	Min. F/C Start Temp	Wiring Diag.	Dim.
-----------	-----------------	------------	----------------	---------------------	---------------------	-------------------	---------------------	-------------------------------	-------	---------------------	--------------	------

F48T12HO - One Lamp Applications

1	PS	120 277	B295PUNVHE-S	0.46 0.22	55	> .98 > .90	0.93	1.69	< 10 < 12	-20/-29	80	-S
---	----	------------	--------------	--------------	----	----------------	------	------	--------------	---------	----	----

F48T12HO - Two Lamp Applications

2	SER-PS	120 277	B295PUNVHE-S	0.88 0.39	105 104	> .98 > .95	0.90	0.86 0.87	< 10	-20/-29	80	-S
---	--------	------------	--------------	--------------	------------	----------------	------	--------------	------	---------	----	----

F60T12HO - One Lamp Applications

1	PS	120 277	B295PUNVHE-S	0.56 0.26	67	> .98 > .92	0.92	1.37	< 10	-20/-29	80	-S
---	----	------------	--------------	--------------	----	----------------	------	------	------	---------	----	----

F60T12HO - Two Lamp Applications

2	SER-PS	120 277	B295PUNVHE-S	1.08 0.47	127 126	> .98 > .95	0.89	0.70 0.71	< 10	-20/-29	80	-S
---	--------	------------	--------------	--------------	------------	----------------	------	--------------	------	---------	----	----

F72T12/BL/HO - Two Lamp Applications

2	SER-RS	120	493B2	1.60	180	> .90	1.00	0.56	< 25	50/10	4	ST
---	--------	-----	-------	------	-----	-------	------	------	------	-------	---	----

F72T12HO - One Lamp Applications

1	PS	120 277	B295PUNVHE-S	0.70 0.31	83	> .98 > .95	0.92	1.11	< 10	-20/-29	80	-S
---	----	------------	--------------	--------------	----	----------------	------	------	------	---------	----	----

F72T12HO - Two Lamp Applications

2	SER-PS	120 277	B295PUNVHE-S	1.34 0.57	157 155	> .98	0.88	0.56 0.57	< 10	-20/-29	80	-S
---	--------	------------	--------------	--------------	------------	-------	------	--------------	------	---------	----	----

F73T12/BL/HO - Two Lamp Applications

2	SER-RS	120	493B2	1.60	180	> .90	1.00	0.56	< 25	50/10	4	ST
---	--------	-----	-------	------	-----	-------	------	------	------	-------	---	----

F96T12HO - One Lamp Applications

1	PS	120 277	B295PUNVHE-S	0.88 0.38	104 103	> .98 > .95	0.92	0.88 0.89	< 10	-20/-29	80	-S
---	----	------------	--------------	--------------	------------	----------------	------	--------------	------	---------	----	----

F96T12HO - Two Lamp Applications

2	SER-PS	120 277	B295PUNVHE-S	1.72 0.72	204 197	> .98	0.88	0.43 0.45	< 10	-20/-29	80	-S
---	--------	------------	--------------	--------------	------------	-------	------	--------------	------	---------	----	----

F96T12HOES (95W) - One Lamp Applications

1	PS	120 277	B295PUNVHE-S	0.73 0.32	87	> .98 > .95	0.92	1.06	< 10	60/16	80	-S
---	----	------------	--------------	--------------	----	----------------	------	------	------	-------	----	----

F96T12HOES (95W) - Two Lamp Applications

2	SER-PS	120 277	B295PUNVHE-S	1.45 0.61	170 167	> .98	0.88	0.52 0.53	< 10	-20/-29	80	-S
---	--------	------------	--------------	--------------	------------	-------	------	--------------	------	---------	----	----

Overall Dimensions		Mounting Dimensions				
Draw #	L	W	H	M	X	
ST	9.50"	2.40"	1.55"	8.89"	1.69"	
-S	11.75"	1.70"	1.18"	11.19"	1.05"	

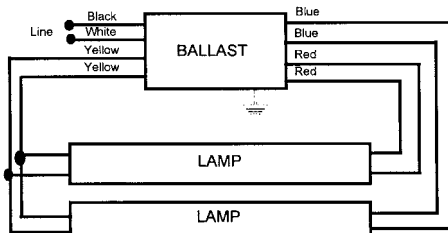
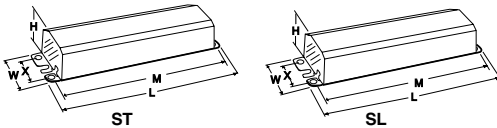

DIAGRAM 4

WIRING DIAGRAMS

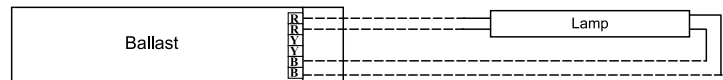
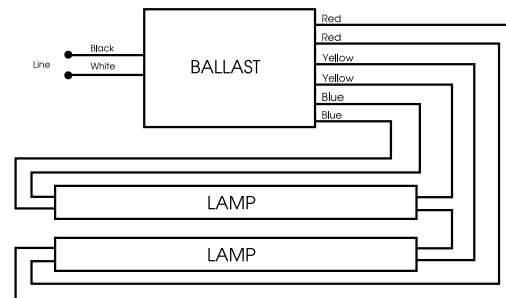

DIAGRAM 40



For One Lamp Operation, Individually cap yellow leads, Insulate to 600V

DIAGRAM 80

TRIAD® ELECTRONIC BALLASTS

FOR F6T2, F8T2, F11T2 AND F13T2 LAMPS

- Programmed Rapid Starting Options
- 1-2 Lamp Applications



T2

Fluorescent-Electronic

Lamp		Line Volts	Catalog Number	Line Current (Amps)	Input Power (Watts)	Power Factor (PF)	Ballast Factor (BF)	Ballast Efficacy Factor (BEF)	THD %	Min. F/C Start Temp	Wiring Diag.	Dim.
Qty.	Starting Method											
F6T2 - One And Two Lamp Applications												
2	SER-PS	120	ES1786X	0.12	14	> .97	1.00	7.14	< 10	0/-18	37	ESX
		277		0.07	15			6.67				
1	PS	120	ES1786X	0.07	8	> .97	1.00	12.50	< 10	0/-18	40	ESX
		277		0.05	9			11.11				
F8T2 - One And Two Lamp Applications												
2	SER-PS	120	ES1786X	0.17	20	> .97	1.00	5.00	< 10	0/-18	37	ESX
		277		0.08	21			4.76				
1	PS	120	ES1786X	0.10	11	> .97	1.00	9.09	< 10	0/-18	40	ESX
		277		0.06								
F11T2 - One And Two Lamp Applications												
2	SER-PS	120	ES1786X	0.20	26	> .97	1.00	3.85	< 10	0/-18	37	ESX
		277		0.09								
1	PS	120	ES1786X	0.12	15	> .97	1.00	6.67	< 10	0/-18	40	ESX
		277		0.07								
F13T2 - One And Two Lamp Applications												
2	SER-PS	120	ES1786X	0.27	31	> .97	1.00	3.23	< 10	0/-18	37	ESX
		277		0.13	32			3.13				
1	PS	120	ES1786X	0.15	16	> .97	1.00	6.25	< 10	0/-18	40	ESX
		277		0.08	17			5.88				

STARTING METHOD LEGEND

IS = Instant Start **RS** = Rapid Start **PAR-PRS** = Parallel Programmed Rapid Start **PAR-RS** = Parallel Rapid Start **SER-IS** = Series Instant Start
PRS = Programmed Rapid Start **PAR-IS** = Parallel Instant Start **SER-PRS** = Series Programmed Rapid Start **SER-RS** = Series Rapid Start

Overall Dimensions		Mounting Dimensions			
Draw #	L	W	H	M	X
ESX	14.13"	1.24"	0.73"	13.78"	—

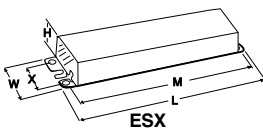

WIRING DIAGRAMS

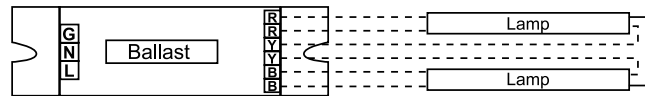

DIAGRAM 37

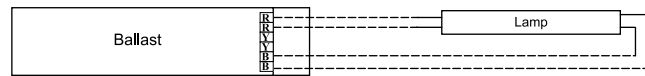

DIAGRAM 40

Energy Management System

DCL[®] with DEMANDflex[®]

DEMANDflex[®] ballasts are high efficiency program start ballasts with the flexibility to be tuned at the circuit level to fixed power levels during installation. They are fully compatible with occupancy sensors and exceed the CEE requirements for high efficiency program start T8 ballasts. DEMANDflex[®] ballasts having tuning capabilities with ranges from 100% to 50% power levels, making them applicable for a wide range of lighting installations.

Installations can start with DEMANDflex[®] ballasts and after installation, the ballasts can be tuned to maximize energy savings with fixed light levels. No dimming control wires are associated with DEMANDflex[®] ballasts which makes them easy to install in all existing fluorescent lighting applications. DEMANDflex[®] ballasts can also be integrated with DCL[®] controls to be part of the most cost-effective lighting system available.

DCL[®] controls allow for local control with energy management systems and external control via the internet for networked managed systems. DCL[®] controls allow for integration with utility demand response programs that provide for improved pricing contracts to end-users in exchange for the utility to have the ability to lower lighting power levels during periods of high demand.



Product Overview

DEMANDflex® Ballasts

- Power level tuning potential to 50%
 - Set the circuit power level at installation
 - Typical 10% to 15% power reduction
- Install the same as standard PRS ballasts
 - No control wires necessary
 - Standard mounting footprint
 - Same wiring as program rapid start ballasts
- High efficiency program start operation
 - Exceeds CEE T8 requirements
 - Compatible with occupancy sensors
- NEMA premium
 - Exceeds CEE T8 requirements
 - Compatible with occupancy sensors

DCL® Controlled Systems

- Reduces lighting power by up to 50%
 - Avoid high peak charges
 - Reduce demand costs
- Programmable fade rates
 - Gradual transitions
 - No disruptions
- Use existing power connections to communicate to the ballasts
 - No control wires
- Implement with various controls and systems
 - BAS Systems
 - Photo Cells
 - Occupancy Sensors
 - Contact Closure

For more information contact Universal or visit www.unvlt.com.

DEMANDflex®

FOR (1), (2), (3) & (4) LAMPS

- Universal DCL® Dimming
- Programmed Rapid Start
- 1, 2, 3, & 4 Lamp Applications
- Visit www.unvlt.com for a comprehensive description of the DCL® system and DEMANDflex® ballasts

DEMANDflex
T8

Lamp		Line Volts	Catalog Number	CertificationLine		Input Current (Amps)	Power Power (Watts)	Ballast Factor (PF)	Ballast Factor (BF)	Efficacy Factor (BEF)	Min. F/C THD %	Start Temp	Wiring Diag.	Dim.		
Qty.	Starting Method			c	UL											
F32T8 - One Lamp Applications																
1	PRS	120	B232PUNVDR-A @ 100%	•	•	0.24	29	> .95	0.88	3.01	< 10	32/0	12a	-A		
			B232PUNVDR-A @ 50%	•	•	0.11	14	> .95	0.28	2.05	< 15	32/0	12a	-A		
		277	B232PUNVDR-A @ 100%	•	•	0.11	29	> .95	0.88	3.03	< 10	32/0	12a	-A		
			B232PUNVDR-A @ 50%	•	•	0.05	14	> .90	0.28	1.96	< 15	32/0	12a	-A		
		120	B232PUNVDRH-A @ 100%	•	•	0.32	38	> .95	1.15	3.03	< 10	32/0	12a	-A		
			B232PUNVDRH-A @ 50%	•	•	0.15	18	> .95	0.50	2.78	< 10	32/0	12a	-A		
		277	B232PUNVDRH-A @ 100%	•	•	0.14	39	> .95	1.15	2.95	< 10	32/0	12a	-A		
			B232PUNVDRH-A @ 50%	•	•	0.07	19	> .95	0.50	2.63	< 10	32/0	12a	-A		
		120	B232PUNVDRL-A @ 100%	•	•	0.20	24	> .95	0.68	2.85	< 10	32/0	12a	-A		
			B232PUNVDRL-A @ 50%	•	•	0.09	11	> .95	0.18	1.64	< 10	32/0	12a	-A		
		277	B232PUNVDRL-A @ 100%	•	•	0.09	24	> .95	0.68	2.85	< 10	32/0	12a	-A		
			B232PUNVDRL-A @ 50%	•	•	0.05	12	> .95	0.18	1.57	< 10	32/0	12a	-A		
		F32T8 - Two Lamp Applications														
		2	PRS	120	B232PUNVDR-A @ 100%	•	•	0.47	57	> .95	0.87	1.53	< 10	32/0	12b	-A
B232PUNVDR-A @ 50%	•				•	0.22	28	> .95	0.34	1.20	< 10	32/0	12b	-A		
277	B232PUNVDR-A @ 100%			•	•	0.20	56	> .95	0.87	1.56	< 10	32/0	12b	-A		
	B232PUNVDR-A @ 50%			•	•	0.10	28	> .95	0.35	1.22	< 10	32/0	12b	-A		
120	B232PUNVDRH-A @ 100%			•	•	0.62	75	> .95	1.15	1.53	< 10	32/0	12b	-A		
	B232PUNVDRH-A @ 50%			•	•	0.30	37	> .90	0.50	1.35	< 10	32/0	12b	-A		
277	B232PUNVDRH-A @ 100%			•	•	0.26	73	> .95	1.15	1.58	< 10	32/0	12b	-A		
	B232PUNVDRH-A @ 50%			•	•	0.13	36	> .90	0.50	1.39	< 10	32/0	12b	-A		
120	B232PUNVDRL-A @ 100%			•	•	0.40	47	> .95	0.71	1.51	< 10	32/0	12b	-A		
	B232PUNVDRL-A @ 50%			•	•	0.19	24	> .95	0.19	0.81	< 10	32/0	12b	-A		
277	B232PUNVDRL-A @ 100%			•	•	0.17	47	> .95	0.71	1.51	< 10	32/0	12b	-A		
	B232PUNVDRL-A @ 50%			•	•	0.09	24	> .95	0.19	0.81	< 10	32/0	12b	-A		
F32T8 - Three Lamp Applications																
3	PRS			120	B332PUNVDR-A @ 100%	•	•	0.70	85	> .95	0.87	1.02	< 10	32/0	12c	-A
		B332PUNVDR-A @ 50%	•		•	0.34	42	> .95	0.35	0.83	< 10	32/0	12c	-A		
		277	B332PUNVDR-A @ 100%	•	•	0.30	83	> .95	0.87	1.05	< 10	32/0	12c	-A		
			B332PUNVDR-A @ 50%	•	•	0.16	41	> .95	0.35	0.85	< 10	32/0	12c	-A		
		120	B332PUNVDRL-A @ 100%	•	•	0.59	72	> .95	0.71	0.99	< 10	32/0	12c	-A		
			B332PUNVDRL-A @ 50%	•	•	0.29	36	> .95	0.22	0.61	< 10	32/0	12c	-A		
		277	B332PUNVDRL-A @ 100%	•	•	0.25	72	> .95	0.71	0.99	< 10	32/0	12c	-A		
			B332PUNVDRL-A @ 50%	•	•	0.13	36	> .95	0.22	0.61	< 10	32/0	12c	-A		
		120	B332PUNVDRH-E @ 100%	•	•	0.95	115	> .95	1.15	1.00	< 10	32/0	12d	-E		
			B332PUNVDRH-E @ 50%	•	•	0.48	57	> .95	0.50	0.88	< 10	32/0	12d	-E		
		277	B332PUNVDRH-E @ 100%	•	•	0.41	111	> .95	1.15	1.04	< 10	32/0	12d	-E		
			B332PUNVDRH-E @ 50%	•	•	0.21	55	> .95	0.50	0.91	< 10	32/0	12d	-E		
		F32T8 - Four Lamp Applications														
		4	PRS	120	B432PUNVDR-E @ 100%	•	•	0.96	116	> .95	0.88	0.75	< 10	32/0	12e	-E
B432PUNVDR-E @ 50%	•				•	0.48	58	> .95	0.35	0.60	< 10	32/0	12e	-E		
277	B432PUNVDR-E @ 100%			•	•	0.41	112	> .95	0.88	0.79	< 10	32/0	12e	-E		
	B432PUNVDR-E @ 50%			•	•	0.20	56	> .95	0.35	0.63	< 15	32/0	12e	-E		
120	B432PUNVDRL-E @ 100%			•	•	0.78	93	> .95	0.71	0.76	< 10	32/0	12e	-E		
	B432PUNVDRL-E @ 50%			•	•	0.37	47	> .95	0.21	0.45	< 15	32/0	12e	-E		
277	B432PUNVDRL-E @ 100%			•	•	0.34	93	> .95	0.71	0.76	< 10	32/0	12e	-E		
	B432PUNVDRL-E @ 50%			•	•	0.17	47	> .95	0.21	0.45	< 15	32/0	12e	-E		

See page 2-7 for Dimensions and Wiring Diagrams

- Universal DCL® Dimming
- Programmed Rapid Start
- 1, 2, 3, & 4 Lamp Applications
- Visit www.unvlt.com for a comprehensive description of the DCL system and DEMANDflex ballasts

Lamp Qty.	Starting Method	Line Volts	Catalog Number	Certification		Input Current (Amps)	Power Power (Watts)	Ballast Factor (PF)	Ballast Factor (BF)	Efficacy Factor (BEF)	Min. F/C THD %	Start Temp	Wiring Diag.	Dim.
				c	UL									
F25T8 - One Lamp Applications														
1	PRS	120	B232PUNVDR-A @ 100%	•	•	0.19	22	> .95	0.87	4.00	< 10	32/0	12a	-A
			B232PUNVDR-A @ 50%	•	•	0.10	12	> .95	0.35	2.93	< 15	32/0	12a	-A
		277	B232PUNVDR-A @ 100%	•	•	0.08	22	> .95	0.88	3.95	< 10	32/0	12a	-A
			B232PUNVDR-A @ 50%	•	•	0.05	13	> .90	0.35	2.82	< 10	32/0	12a	-A
		120	B232PUNVDRH-A @ 100%	•	•	0.25	30	> .95	1.16	3.87	< 10	32/0	12a	-A
			B232PUNVDRH-A @ 50%	•	•	0.12	14	> .95	0.50	3.57	< 10	32/0	12a	-A
		277	B232PUNVDRH-A @ 100%	•	•	0.11	30	> .95	1.16	3.81	< 10	32/0	12a	-A
			B232PUNVDRH-A @ 50%	•	•	0.06	15	> .90	0.50	3.33	< 10	32/0	12a	-A
		120	B232PUNVDRL-A @ 100%	•	•	0.15	18	> .95	0.69	3.85	< 10	32/0	12a	-A
			B232PUNVDRL-A @ 50%	•	•	0.08	10	> .95	0.18	1.84	< 15	32/0	12a	-A
		277	B232PUNVDRL-A @ 100%	•	•	0.07	18	> .95	0.69	3.77	< 10	32/0	12a	-A
			B232PUNVDRL-A @ 50%	•	•	0.04	10	> .95	0.18	1.75	< 15	32/0	12a	-A
F25T8 - Two Lamp Applications														
2	PRS	120	B232PUNVDR-A @ 100%	•	•	0.36	44	> .95	0.87	2.01	< 10	32/0	12b	-A
			B232PUNVDR-A @ 50%	•	•	0.19	23	> .95	0.35	1.56	< 10	32/0	12b	-A
		277	B232PUNVDR-A @ 100%	•	•	0.16	43	> .95	0.87	2.05	< 10	32/0	12b	-A
			B232PUNVDR-A @ 50%	•	•	0.09	23	> .95	0.35	1.53	< 10	32/0	12b	-A
		120	B232PUNVDRH-A @ 100%	•	•	0.46	55	> .95	1.15	2.09	< 10	32/0	12b	-A
			B232PUNVDRH-A @ 50%	•	•	0.21	26	> .90	0.50	1.92	< 10	32/0	12b	-A
		277	B232PUNVDRH-A @ 100%	•	•	0.20	55	> .95	1.15	2.08	< 10	32/0	12b	-A
			B232PUNVDRH-A @ 50%	•	•	0.10	26	> .90	0.50	1.92	< 10	32/0	12b	-A
		120	B232PUNVDRL-A @ 100%	•	•	0.30	36	> .95	0.69	1.93	< 10	32/0	12b	-A
			B232PUNVDRL-A @ 50%	•	•	0.15	18	> .95	0.19	1.06	< 10	32/0	12b	-A
		277	B232PUNVDRL-A @ 100%	•	•	0.13	35	> .95	0.69	1.95	< 10	32/0	12b	-A
			B232PUNVDRL-A @ 50%	•	•	0.07	18	> .95	0.19	1.03	< 10	32/0	12b	-A
F25T8 - Three Lamp Applications														
3	PRS	120	B332PUNVDR-A @ 100%	•	•	0.55	66	> .95	0.87	1.32	< 10	32/0	12c	-A
			B332PUNVDR-A @ 50%	•	•	0.27	33	> .95	0.35	1.06	< 10	32/0	12c	-A
		277	B332PUNVDR-A @ 100%	•	•	0.24	65	> .95	0.87	1.34	< 10	32/0	12c	-A
			B332PUNVDR-A @ 50%	•	•	0.13	32	> .95	0.35	1.09	< 15	32/0	12c	-A
		120	B332PUNVDRL-A @ 100%	•	•	0.47	56	> .95	0.71	1.27	< 10	32/0	12c	-A
			B332PUNVDRL-A @ 50%	•	•	0.24	28	> .95	0.23	0.81	< 10	32/0	12c	-A
		277	B332PUNVDRL-A @ 100%	•	•	0.21	55	> .95	0.71	1.29	< 10	32/0	12c	-A
			B332PUNVDRL-A @ 50%	•	•	0.11	29	> .90	0.23	0.80	< 10	32/0	12c	-A
		120	B332PUNVDRH-E @ 100%	•	•	0.74	89	> .95	1.17	1.31	< 10	32/0	12d	-E
			B332PUNVDRH-E @ 50%	•	•	0.35	42	> .95	0.50	1.19	< 15	32/0	12d	-E
		277	B332PUNVDRH-E @ 100%	•	•	0.33	89	> .95	1.17	1.31	< 10	32/0	12d	-E
			B332PUNVDRH-E @ 50%	•	•	0.16	43	> .95	0.50	1.16	< 15	32/0	12d	-E
F25T8 - Four Lamp Applications														
4	PRS	120	B432PUNVDR-E @ 100%	•	•	0.75	90	> .95	0.89	0.99	< 10	32/0	12e	-E
			B432PUNVDR-E @ 50%	•	•	0.37	44	> .95	0.35	0.80	< 15	32/0	12e	-E
		277	B432PUNVDR-E @ 100%	•	•	0.33	89	> .95	0.89	1.00	< 10	32/0	12e	-E
			B432PUNVDR-E @ 50%	•	•	0.17	44	> .90	0.35	0.80	< 15	32/0	12e	-E
		120	B432PUNVDRL-E @ 100%	•	•	0.61	73	> .95	0.71	0.97	< 10	32/0	12e	-E
			B432PUNVDRL-E @ 50%	•	•	0.31	37	> .95	0.21	0.56	< 15	32/0	12e	-E
		277	B432PUNVDRL-E @ 100%	•	•	0.27	72	> .95	0.71	0.98	< 10	32/0	12e	-E
			B432PUNVDRL-E @ 50%	•	•	0.15	38	> .90	0.21	0.56	< 15	32/0	12e	-E

See page 2-7 for Dimensions and Wiring Diagrams

DEMANDflex®

FOR (1), (2), (3) & (4) LAMPS

- Universal DCL® Dimming
- Programmed Rapid Start
- 1, 2, 3, & 4 Lamp Applications
- Visit www.unvlt.com for a comprehensive description of the DCL system and DEMANDflex ballasts

DEMANDflex
T8

Lamp Qty.	Starting Method	Line Volts	Catalog Number	CertificationLine		Input Current (Amps)	Power Power (Watts)	Ballast Factor (PF)	Ballast Factor (BF)	Efficacy Factor (BEF)	Min. F/C THD %	Start Temp	Wiring Diag.	Dim.		
				c	UL											
F17T8 - One Lamp Applications																
1	PRS	120	B232PUNVDR-A @ 100%	•	•	0.14	16	> .95	0.92	5.65	< 10	32/0	12a	-A		
			B232PUNVDR-A @ 50%	•	•	0.08	10	> .95	0.27	2.81	< 15	32/0	12a	-A		
		277	B232PUNVDR-A @ 100%	•	•	0.06	17	> .95	0.92	5.48	< 10	32/0	12a	-A		
			B232PUNVDR-A @ 50%	•	•	0.04	10	> .85	0.27	2.66	< 15	32/0	12a	-A		
		120	B232PUNVDRH-A @ 100%	•	•	0.18	22	> .95	1.15	5.23	< 10	32/0	12a	-A		
			B232PUNVDRH-A @ 50%	•	•	0.09	11	> .95	0.50	4.63	< 15	32/0	12a	-A		
		277	B232PUNVDRH-A @ 100%	•	•	0.09	22	> .95	1.15	5.23	< 10	32/0	12a	-A		
			B232PUNVDRH-A @ 50%	•	•	0.05	11	> .90	0.50	4.55	< 15	32/0	12a	-A		
		120	B232PUNVDRL-A @ 100%	•	•	0.11	13	> .95	0.70	5.47	< 10	32/0	12a	-A		
			B232PUNVDRL-A @ 50%	•	•	0.09	10	> .95	0.20	1.98	< 15	32/0	12a	-A		
		277	B232PUNVDRL-A @ 100%	•	•	0.05	13	> .95	0.70	5.22	< 10	32/0	12a	-A		
			B232PUNVDRL-A @ 50%	•	•	0.04	11	> .85	0.20	1.87	< 15	32/0	12a	-A		
		F17T8 - Two Lamp Applications														
		2	PRS	120	B232PUNVDR-A @ 100%	•	•	0.25	30	> .95	0.90	3.00	< 10	32/0	12b	-A
B232PUNVDR-A @ 50%	•				•	0.13	16	> .95	0.27	1.72	< 10	32/0	12b	-A		
277	B232PUNVDR-A @ 100%			•	•	0.13	30	> .95	0.90	3.00	< 10	32/0	12b	-A		
	B232PUNVDR-A @ 50%			•	•	0.06	16	> .95	0.27	1.67	< 10	32/0	12b	-A		
120	B232PUNVDRH-A @ 100%			•	•	0.32	38	> .95	1.16	3.05	< 10	32/0	12b	-A		
	B232PUNVDRH-A @ 50%			•	•	0.16	19	> .95	0.50	2.63	< 10	32/0	12b	-A		
277	B232PUNVDRH-A @ 100%			•	•	0.14	39	> .95	1.16	2.97	< 10	32/0	12b	-A		
	B232PUNVDRH-A @ 50%			•	•	0.07	19	> .90	0.50	2.63	< 10	32/0	12b	-A		
120	B232PUNVDRL-A @ 100%			•	•	0.21	25	> .95	0.69	2.78	< 10	32/0	12b	-A		
	B232PUNVDRL-A @ 50%			•	•	0.12	15	> .95	0.19	1.29	< 15	32/0	12b	-A		
277	B232PUNVDRL-A @ 100%			•	•	0.09	25	> .95	0.69	2.76	< 10	32/0	12b	-A		
	B232PUNVDRL-A @ 50%			•	•	0.06	15	> .95	0.19	1.24	< 10	32/0	12b	-A		
F17T8 - Three Lamp Applications																
3	PRS			120	B332PUNVDR-A @ 100%	•	•	0.40	48	> .95	0.89	1.86	< 10	32/0	12c	-A
		B332PUNVDR-A @ 50%	•		•	0.20	24	> .95	0.36	1.51	< 10	32/0	12c	-A		
		277	B332PUNVDR-A @ 100%	•	•	0.18	48	> .95	0.89	1.86	< 10	32/0	12c	-A		
			B332PUNVDR-A @ 50%	•	•	0.10	24	> .90	0.36	1.51	< 15	32/0	12c	-A		
		120	B332PUNVDRL-A @ 100%	•	•	0.33	40	> .95	0.73	1.83	< 10	32/0	12c	-A		
			B332PUNVDRL-A @ 50%	•	•	0.18	22	> .95	0.23	1.05	< 10	32/0	12c	-A		
		277	B332PUNVDRL-A @ 100%	•	•	0.15	40	> .95	0.73	1.83	< 10	32/0	12c	-A		
			B332PUNVDRL-A @ 50%	•	•	0.09	23	> .85	0.23	1.02	< 15	32/0	12c	-A		
		120	B332PUNVDRH-E @ 100%	•	•	0.54	65	> .95	1.19	1.83	< 10	32/0	12d	-E		
			B332PUNVDRH-E @ 50%	•	•	0.25	32	> .95	0.51	1.59	< 15	32/0	12d	-E		
		277	B332PUNVDRH-E @ 100%	•	•	0.24	65	> .95	1.19	1.84	< 10	32/0	12d	-E		
			B332PUNVDRH-E @ 50%	•	•	0.12	32	> .90	0.51	1.59	< 15	32/0	12d	-E		
		F17T8 - Four Lamp Applications														
		4	PRS	120	B432PUNVDR-E @ 100%	•	•	0.53	64	> .95	0.91	1.42	< 10	32/0	12e	-E
B432PUNVDR-E @ 50%	•				•	0.27	32	> .95	0.35	1.09	< 15	32/0	12e	-E		
277	B432PUNVDR-E @ 100%			•	•	0.24	63	> .95	0.91	1.44	< 10	32/0	12e	-E		
	B432PUNVDR-E @ 50%			•	•	0.13	32	> .90	0.35	1.09	< 15	32/0	12e	-E		
120	B432PUNVDRL-E @ 100%			•	•	0.43	52	> .95	0.73	1.41	< 10	32/0	12e	-E		
	B432PUNVDRL-E @ 50%			•	•	0.26	31	> .95	0.21	0.69	< 15	32/0	12e	-E		
277	B432PUNVDRL-E @ 100%			•	•	0.20	52	> .95	0.73	1.41	< 10	32/0	12e	-E		
	B432PUNVDRL-E @ 50%			•	•	0.12	31	> .90	0.21	0.67	< 15	32/0	12e	-E		

See page 2-7 for Dimensions and Wiring Diagrams

- Universal DCL® Dimming
- Programmed Rapid Start
- 2 Lamp Applications for T5HO
- 1 & 2 Lamp Applications for T5
- Visit www.unvlt.com for a comprehensive description of the DCL system and DEMANDflex ballasts

Lamp		Line Volts	Catalog Number	Certification		Line Current (Amps)	Input Power (Watts)	Power Factor (PF)	Ballast Factor (BF)	Ballast Efficacy Factor (BEF)	THD %	Min. F/C Start Temp	Wiring Diag.	Dim.
Qty.	Starting Method			c	UL									
F28T5 - One Lamp Applications														
1	PRS	120	B128PUNVDRH-D @ 100%	•	•	0.32	37	> .99	1.15	3.11	< 10	50/10	12g	-D
			B128PUNVDRH-D @ 50%	•	•	0.16	19	> .99	0.38	2.00	< 10	50/10	12g	-D
		277	B128PUNVDRH-D @ 100%	•	•	0.14	37	> .96	1.15	3.11	< 10	50/10	12g	-D
			B128PUNVDRH-D @ 50%	•	•	0.08	19	> .88	0.38	2.00	< 10	50/10	12g	-D
F28T5 - Two Lamp Applications														
2	PRS	120	B228PUNVDRH-D @ 100%	•	•	0.60	72	> .95	1.15	1.60	< 10	50/10	12f	-D
			B228PUNVDRH-D @ 50%	•	•	0.30	36	> .95	0.51	1.42	< 10	50/10	12f	-D
		277	B228PUNVDRH-D @ 100%	•	•	0.25	70	> .95	1.15	1.64	< 10	50/10	12f	-D
			B228PUNVDRH-D @ 50%	•	•	0.13	35	> .95	0.50	1.43	< 10	50/10	12f	-D
F35T5 - Two Lamp Applications														
2	PRS	120	B228PUNVDRH-D @ 100%	•	•	0.75	90	> .95	1.13	1.26	< 10	50/10	12f	-D
			B228PUNVDRH-D @ 50%	•	•	0.38	45	> .95	0.51	1.13	< 10	50/10	12f	-D
		277	B228PUNVDRH-D @ 100%	•	•	0.31	87	> .95	1.13	1.30	< 10	50/10	12f	-D
			B228PUNVDRH-D @ 50%	•	•	0.17	44	> .95	0.51	1.16	< 10	50/10	12f	-D
F21T5 - One Lamp Applications														
1	PRS	120	B128PUNVDRH-D @ 100%	•	•	0.25	28	> .99	1.15	4.11	< 10	50/10	12g	-D
			B128PUNVDRH-D @ 50%	•	•	0.13	15	> .99	0.38	2.53	< 10	50/10	12g	-D
		277	B128PUNVDRH-D @ 100%	•	•	0.12	28	> .94	1.15	4.11	< 10	50/10	12g	-D
			B128PUNVDRH-D @ 50%	•	•	0.07	15	> .84	0.38	2.53	< 10	50/10	12g	-D
F21T5 - Two Lamp Applications														
2	PRS	120	B228PUNVDRH-D @ 100%	•	•	0.47	56	> .95	1.16	2.07	< 10	50/10	12f	-D
			B228PUNVDRH-D @ 50%	•	•	0.23	28	> .95	0.51	1.82	< 10	50/10	12f	-D
		277	B228PUNVDRH-D @ 100%	•	•	0.20	55	> .95	1.16	2.11	< 10	50/10	12f	-D
			B228PUNVDRH-D @ 50%	•	•	0.11	28	> .90	0.51	1.82	< 10	50/10	12f	-D
F14T5 - Two Lamp Applications														
2	PRS	120	B228PUNVDRH-D @ 100%	•	•	0.34	40	> .95	1.17	2.93	< 10	50/10	12f	-D
			B228PUNVDRH-D @ 50%	•	•	0.16	19	> .95	0.52	2.74	< 10	50/10	12f	-D
		277	B228PUNVDRH-D @ 100%	•	•	0.15	40	> .95	1.17	2.93	< 10	50/10	12f	-D
			B228PUNVDRH-D @ 50%	•	•	0.08	20	> .85	0.52	2.60	< 10	50/10	12f	-D
F54T5HO - Two Lamp Applications														
2	PRS	120	B254PUNVDR-D @ 100%	•	•	1.00	120	> .95	1.00	0.83	< 10	0/-18	12f	-D
			B254PUNVDR-D @ 50%	•	•	0.50	60	> .95	0.45	0.75	< 10	0/-18	12f	-D
		277	B254PUNVDR-D @ 100%	•	•	0.43	120	> .95	1.00	0.83	< 10	0/-18	12f	-D
			B254PUNVDR-D @ 50%	•	•	0.22	60	> .90	0.45	0.75	< 10	0/-18	12f	-D
FT55W/2G11 - Two Lamp Applications														
2	PRS	120	B254PUNVDR-D @ 100%	•	•	0.90	108	> .95	1.06	0.98	< 10	0/-18	12f	-D
			B254PUNVDR-D @ 50%	•	•	0.41	50	> .95	0.57	1.14	< 10	0/-18	12f	-D
		277	B254PUNVDR-D @ 100%	•	•	0.39	106	> .95	1.06	1.00	< 10	0/-18	12f	-D
			B254PUNVDR-D @ 50%	•	•	0.19	50	> .95	0.57	1.14	< 10	0/-18	12f	-D
FT50W/2G11 - Two Lamp Applications														
2	PRS	120	B254PUNVDR-D @ 100%	•	•	0.97	115	> .95	1.10	0.96	< 10	0/-18	12f	-D
			B254PUNVDR-D @ 50%	•	•	0.47	57	> .95	0.63	1.11	< 10	0/-18	12f	-D
		277	B254PUNVDR-D @ 100%	•	•	0.42	113	> .95	1.11	0.98	< 10	0/-18	12f	-D
			B254PUNVDR-D @ 50%	•	•	0.21	57	> .95	0.63	1.11	< 10	0/-18	12f	-D
FC55T5-55W - Two Lamp Applications														
2	PRS	120	B254PUNVDR-D @ 100%	•	•	0.88	106	> .95	1.04	0.98	< 10	0/-18	12f	-D
			B254PUNVDR-D @ 50%	•	•	0.41	49	> .95	0.56	1.14	< 10	0/-18	12f	-D
		277	B254PUNVDR-D @ 100%	•	•	0.38	104	> .95	1.04	1.00	< 10	0/-18	12f	-D
			B254PUNVDR-D @ 50%	•	•	0.19	48	> .95	0.56	1.17	< 10	0/-18	12f	-D
F21T5-55W - One Lamp Application														
2	PRS	120	B254PUNVDR-D @ 100%	•	•	0.88	106	> .95	1.04	0.98	< 10	0/-18	12f	-D
			B254PUNVDR-D @ 50%	•	•	0.41	49	> .95	0.56	1.14	< 10	0/-18	12f	-D

See page 2-7 for Dimensions and Wiring Diagrams

WIRING DIAGRAMS

Note: Nominal dimensions provided above
Contact Universal for drawings and/or tolerances

Ballast case must be grounded. A star washer or other paint penetrating device is required.

Wiring Diagram 12a

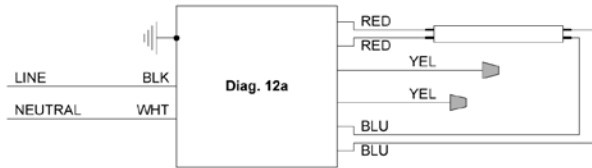

Wiring Diagram 12e

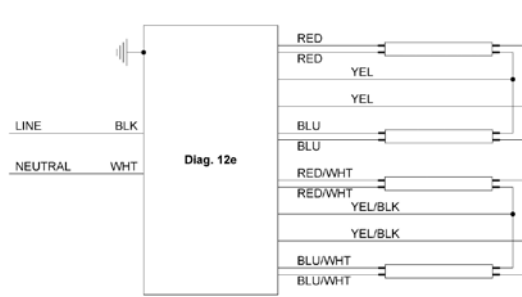

Wiring Diagram 12b

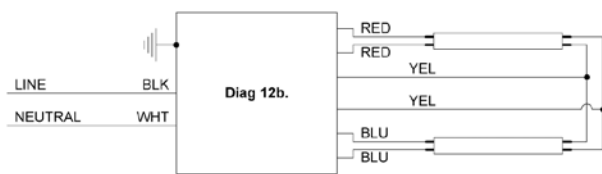

Wiring Diagram 12f

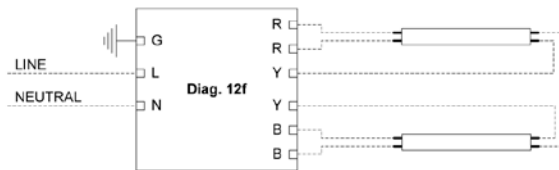

Wiring Diagram 12c

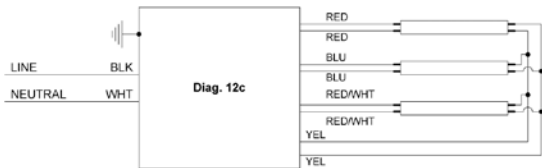

Wiring Diagram 12g

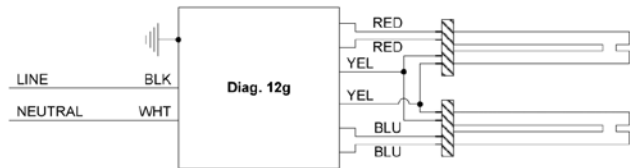

Wiring Diagram 12d

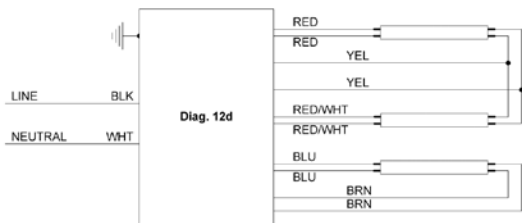

Overall Dimensions			Mounting Dimensions		
Draw #	L	W	H	M	X
-A	9.50"	1.70"	1.18"	8.89"	1.69"
-D	16.88"	1.18"	1.00"	16.20"	—
-E	16.88"	1.82"	1.18"	16.28"	—

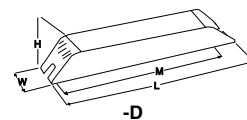
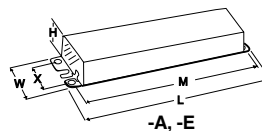

DCL CONTROLS

MODEL	DESCRIPTION
LP12DCLUNV-xx**	Circuit Control Panel
SC20DCLUNV**	Single Circuit Controller
MC20DCLUNV**	Open Style Single Circuit Controller
RSDMCL51	Contact Interface Controller
WTPDCL51 ^Δ	Time/Photo Controller
WPS5527K	Photo Sensor for WTPDCL

xx = number of circuits (03 - 12)

* For additional lighting system controllers, contact Universal Lighting.

** Modbus versions of these controls are available.

^Δ Consult Universal for configuration options.

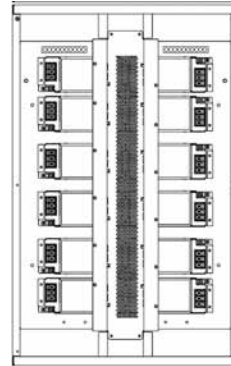

LP12DCLUNV-xx		
Dimensions		Mounting
Length	32"	24"
Width	20"	16"
Depth	4.3"	

The same cabinet size is used for the four different panels. The quantity of individual controllers installed is determined by the model number.

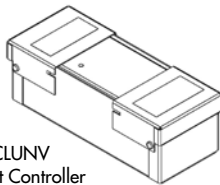

SC20DCLUNV
Single Circuit Controller

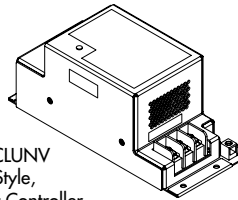

MC20DCLUNV
Open Style,
Single Circuit Controller

SC20DCLUNV		MOUNTING PATTERN	
Dimensions		8.46	
Length	9.66"	X	X
Width	3.98"	1.50	2.50
Depth	3.21"	X	X

Circuit control panels are used to send commands down the lighting circuit to the DemandFlex ballasts. The LP12DCLUNV-xx panels are available with 3 to 12 integral circuit control modules. If more than 12 circuits are being controlled, additional panels can be used.

The SC20DCLUNV is used when there are a small number of circuits or space limitations prevent the use of an LP12DCLUNV panel.

One RSDMCL51 or WTPDCL51 can control up to 63 circuits. If more than 63 circuits are to be controlled, an RSDMCL can be connected in parallel with either controller for another 63 circuits.

Stand Alone Time Clock/Photo Cell Control

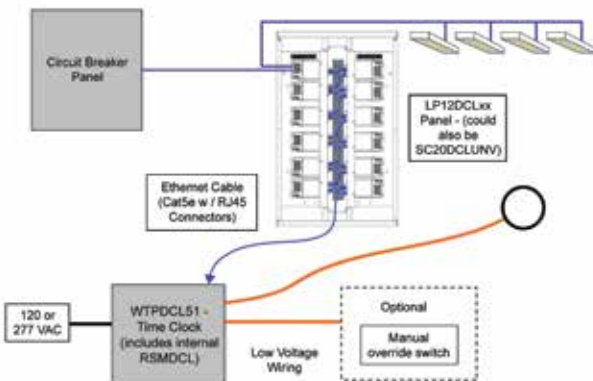

The WTPDCL51 controller provides time of day scheduling and can also be connected to the WPS5527K Photo Cell for daylight harvesting. Manual override switches are also available.

Note: Nominal dimensions provided above
Contact Universal for drawings and/or tolerances

Contact Closure Interface Control

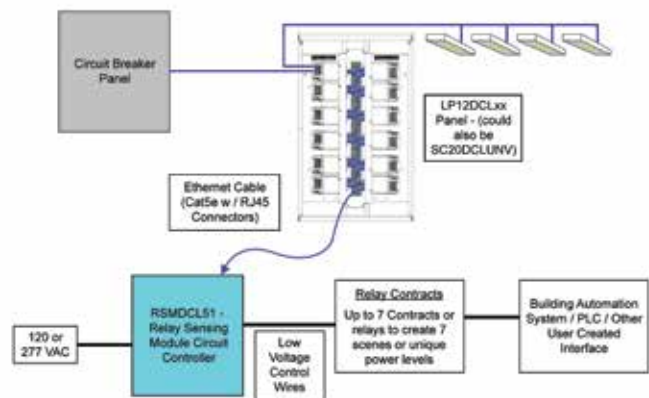

The RSDMCL51 controller integrates with external relays or switches to translate commands to the DCL system. This controller can be used to interface with building automation systems, PLC's, or switches. These systems may also incorporate photo cells for daylight harvesting.

Controllable Lighting

Fluorescent Energy Management / Dimming Ballasts and Controls

The effective dimming of fluorescent lights delivers a wide range of benefits: greater control of workspace lighting, ability to create a mood, energy savings, and more.

Universal Lighting Technologies (“Universal”) line of electronic dimming ballasts and controls lets you accomplish these goals with a variety of products to suit your dimming needs. From light level switching and analog dimming to digital dimming and controls, Universal has the products and technologies to meet today’s dimming requirements for energy savings and controllable lighting.

Product Overview

Universal offers five different families of dimming products that can be used for today's dimming requirements for architectural lighting control and energy management applications:

BallaStar: Step-dimming

SuperDim: Analog (0 to 10 volt) dimming

DaliPRO: Digital dimming with the DALI protocol

DaliPRO Premium: Parallel-lamp digital dimming (DALI)

VariPRO: Parallel-lamp analog dimming

LevelPRO: Parallel-lamp step dimming

BallaStar® Light Level Switching (S30 & S50)

Our Ballastar® line offers two options of light level switching (either 100/50% or 100/60/30%). That makes Ballastar® a cost-effective solution for both new construction and retrofits.

Universal Ballastar® ballasts are designed to ensure optimum lamp performance. Their Lamp Current Crest Factors are well below the maximum 1.7 ANSI standard — and they start the lamps according to ANSI recommendations at all dimming levels. Both of these important design parameters ensure optimum lamp performance. In addition, Ballastar® ballasts actually increase cathode heating when dimming to maintain the cathode's proper temperature, which enhances lamp life and performance stability.

- 1, 2, & 3 lamp models for 120 & 277 volt
- Switches to preset light levels, keeping all lamps illuminated
- Eliminates the dark spots associated with inboard/outboard configurations
- Connects with two line voltage power leads
 - Wires the same as an inboard/outboard fixture
 - No special controls required; uses two wall switches
- Meets all ASHRAE 90.1 and California Title 24 requirements for lighting control
- THD <10%
- Lower installed costs; less wiring and equipment required



Ballastar® Light Level Switching for ultimate control.

Product Overview

SuperDim® Analog Dimming Ballasts

Universal Lighting's new SuperDim® analog dimming ballasts are a cost-effective choice for large scale dimming applications. SuperDim® ballasts are designed for T8 and T5 linear fluorescent lamps and T4 4-pin quad and triple compact fluorescent lamps.

SuperDim® ballasts are compatible with a wide range of 0 – 10 volt controls and can be connected to photocells for daylight harvesting. The resulting energy savings makes it easy to adhere to even the strictest energy requirements, including California Title 24 and ASHRAE 90.1.

These versatile ballasts offer programmed rapid start technology for longer lamp life. They also incorporate end-of-lamp-life shutdown circuits, low profile designs and < 10% THD at full bright.

Features and Benefits

- Ideal for T8 and T5 linear fluorescent lamps and T4 4-pin quad and triple compact fluorescent lamps
- Compatible with most 0 – 10 volt manufactured controls
- Daylight harvesting options with photocells for maximum energy savings
- Programmed rapid start technology maximizes lamp life
- Low profile design for fixture design flexibility
- End-of-lamp-life shutdown circuitry ensures safe operation
- < 10% THD at full bright
- Universal input voltage (120–277 volts) for installation flexibility

Product Overview

DaliPRO™ Digital Dimming Ballasts for DALI

DaliPRO™ ballasts from Universal Lighting let you take full advantage of the Digital Addressable Lighting Interface (DALI) standard...and that means greater flexibility, greater savings.

The DALI Advantage

The DALI protocol uses a 2-wire control loop to communicate with up to 64 ballasts. Broadcast, group and individual addressing is used to control light levels, recall scenes and poll ballast status.

Many DALI-compatible controls are now available from established manufacturers; and new varieties are being developed daily.

DaliPRO Features and Benefits

- Available for T8, T5, T5HO and compact fluorescent lamps
- Provides dimming down to 1% for linear lamps and 3% for compact fluorescent lamps
- Lets you adapt instantly to additions or changes in lighting design without ballast or fixture rewiring
- Offers status/performance data, including lamp status and system faults
- Low profile designs for easy installation in a wide variety of fixtures
- Universal input voltage (120– 277 volts)
 - Installer-friendly; ensures you have the right ballast every time
 - Reduces inventory costs and requirements
- End-of-Lamp Life Shutdown with auto reset circuitry for safe operation
- Programmed Rapid Start for long lamp life

DaliPRO Premium

DaliPRO Premium performs the same as standard DaliPRO but with the additional feature of parallel-lamp operation.



Product Overview

VariPRO & LevelPRO Parallel-Lamp Dimming Ballasts

Universal Lighting Technologies' parallel-lamp dimming families combine new performance features with maximum energy savings. These ballasts provide parallel-lamp operation – when one lamp fails the other remains lit. This prevents fixture from going dark and simplifies troubleshooting and maintenance operations.

Performance

- Total Harmonic Distortion (THD) < 10%
- Power Factor (PF) > 10%
- NEMA Premium
- RoHS Compliant

General Features and Benefits

- **Quick Programmed Start Technology**
 - Start time less than 700ms
 - Maintains long lamp life in frequently switched applications
- **High Efficiency Operation**
 - Complies with CEE and NEMA Premium
 - Incorporates Anti-Striation circuitry
 - Designed for use with 30, 28, and 25 Watt energy saving lamps
- **True Parallel-Lamp Operation**
 - When one lamp fails, other lamps continue to operate normally
 - Simplifies fixture troubleshooting
- **Universal Input Voltage and 347 Models**



VariPRO Features and Benefits

- **Analog (0-10V) Dimming Control**
 - Compatible with industry standard 0-10V controls and photocells
 - Ideal for daylight harvesting



LevelPRO Features and Benefits

- **Line Voltage Step Dimming Control**
 - Uses standard wall switches
 - Provides even fixture illumination

Application And Operating Information

Although dimming ballasts follow similar installation and operating guidelines as electronic ballasts, application notes and other training materials, written specifically for dimming ballasts, are provided on www.unvlt.com website.

SAFETY

Analog dimming ballasts are controlled by using a low voltage 0-10VDC control circuit. Care should be taken to insure that the line voltage (AC) wires are not connected to the low voltage DC wires. SuperDim® Electronic dimming ballasts have a protection circuit that will sense if the ballast has been connected in this manner and not harm the ballast.

Light Level Switching Installation Note

The two power leads for the light level switching ballasts must be connected to the same power circuit. The leads should connect to separate switches or relays for control of the light level switching operation. Connection of the input leads to separate power circuits can damage the ballasts.

Note:

Do not connect any other ballast to the load side of the switches controlling the switched dimming ballast.

Compatible Dimming Controls

For a listing of compatible controls for universal analog ballasts, please consult catalog page 3-7, or call 1-800-BALLAST or check out the Dimming and Controls section of our home page at www.unvlt.com.

Fusing

Class P ballasts do not require fusing. Fusing can be used when a single circuit has a large number of fixtures/ballasts. For a comprehensive list of appropriate fuses, contact our Technical Engineering Services (TES) Department at 1-800-BALLAST.

Detailed Operating Instructions

For additional information on all of Universal's dimming products, consult our website at www.unvlt.com. Application notes, dimming brochures and online training is available

Controls For Analog Dimming Ballasts

Manual Controls, Photo-Sensors, Wall Stations & Hand Held Remotes

Manufacturer	Website	Telephone
Cooper Controls	www.coopercontrol.com	(800) 553-3879
DimOnOff	www.dimonoff.com	(418) 682-3636
Douglas Lighting Controls, Inc	www.douglaslightingcontrol.com	(604) 873-2797
HUNT Dimming	www.hunt DimMING.com	(970) 484-9048
Lehigh Electric Products Co.	www.lehighdim.com	(610) 395-3386
Leviton	www.leviton.com/les	1-800-736-6682
Lutron	www.lutron.com/universal	(888) LUTRON1 - Sales (800) 523-9466 - Technical Support
NexLight	www.nexlight.com	(218) 828-3700
The Watt Stopper, Inc	www.wattstopper.com	(800) 879-8585
Marlin Controls	www.marlincontrols.com	(800) 788-5750
Sensor Switch, Inc.	www.sensorswitch.com	(800) 727-7483 (800) PASSIVE
Touch-Plate Lighting Controls	www.touchplate.com	(260) 426-1565

Occupancy Sensors

Manufacturer	Website	Telephone
Cooper Controls	www.coopercontrol.com	(800) 553-3879
DimOnOff	www.dimonoff.com	(418) 682-3636
Douglas Lighting Controls, Inc	www.douglaslightingcontrol.com	(604) 873-2797
Lehigh Electric Products Co.	www.lehighdim.com	(610) 395-3386
Lutron	www.lutron.com/universal	(888) LUTRON1 - Sales (800) 523-9466 - Technical Support
NexLight	www.nexlight.com	(218) 828-3700
Marlin Controls	www.marlincontrols.com	(800) 788-5750
Sensor Switch, Inc.	www.sensorswitch.com	(800) 727-7483 (800) PASSIVE
Touch-Plate Lighting Controls	www.touchplate.com	(260) 426-1565

Systems: Control Panels, Building Management Systems, etc

Manufacturer	Website	Telephone
DimOnOff	www.dimonoff.com	(418) 682-3636
Douglas Lighting Controls, Inc	www.douglaslightingcontrol.com	(604) 873-2797
Cooper Controls	www.coopercontrol.com	(800) 553-3879
HUNT Dimming	www.hunt DimMING.com	(970) 484-9048
Lehigh Electric Products Co.	www.lehighdim.com	(610) 395-3386
Leviton	www.leviton.com/les	1-800-736-6682
Lutron	www.lutron.com/universal	(888) LUTRON1 - Sales (800) 523-9466 - Technical Support
NexLight	www.nexlight.com	(218) 828-3700
The Watt Stopper, Inc	www.wattstopper.com	(800) 879-8585
Marlin Controls	www.marlincontrols.com	(800) 788-5750
Touch-Plate Lighting Controls	www.touchplate.com	(260) 426-1565



The information listed above is provided by Universal Lighting Technologies to facilitate development of dimming systems. All information has been provided by the controls manufacturers, and Universal Lighting Technologies makes no guarantee regarding its accuracy. The reader is advised to contact these, and other manufacturers of analog dimming systems, to obtain application advice, to determine availability of the controls listed above, and to learn about other controls that may be offered.

Data is subject to change without notice.

Lamp		Line Volts	Catalog Number	Line Current (Amps)	Input Power (Watts)	Power Factor (PF)	Ballast Factor (BF)	Ballast Efficacy Factor (BEF)	THD %	Min. F/C Start Temp	Wiring Diag.	Dim.
Qty.	Starting Method											
F1728												
1	PRS	120 277	B132PUNVDV3-A	0.18 0.08	21 20	>.95	1.02	5.10	<10%	32/0	1	-A
2	PRS	120 277	B232PUNVDV3-A	0.33 0.14	38 38	>.98	1.01	2.69	<10%	32/0	2	-A
F32T8 *												
1	PRS	120 277	B132PUNVDV3-A	0.30 0.13	35 35	>.95	1.00	2.90	<10%	32/0	1	-A
2	PRS	120 277	B232PUNVDV3-A	0.58 0.25	67 66	>.98	1.00	1.52	<10%	32/0	2	-A
F14T5												
1	PRS	120 277	B114PUNVDV3-D	0.15 0.07	18 18	>.95	1.00	5.61	<10%	50/10	1	-D
2	PRS	120 277	B214PUNVDV3-D	0.28 0.13	33 33	>.95	1.00	3.02	<10%	50/10	2	-D
F21T5												
1	PRS	120 277	B128PUNVDV3-D	0.23 0.10	25 24	>.95	1.00	4.15	<10%	50/10	1	-D
2	PRS	120 277	B228PUNVDV3-D	0.40 0.17	45 45	>.95	1.00	3.02	<10%	50/10	2	-D
F28T5 *												
1	PRS	120 277	B128PUNVDV3-D	0.29 0.13	32 32	>.95	1.00	3.13	<10%	50/10	1	-D
2	PRS	120 277	B228PUNVDV3-D	0.52 0.22	62 61	>.95	1.00	1.64	<10%	50/10	2	-D
F35T5												
1		120 277	B135PUNVDV3-D	0.35 0.15	41 41	>.95	1.00	2.45	<10%	50/10	1	-D
CFQ13W/G24q												
1	PRS	120 277	C213UNVDV3ME	0.15 0.07	18 18	>.90	1.00	5.56	<15%	32/0	3	-ME
2	PRS	120 277	C213UNVDV3ME	0.27 0.12	32 32	>.95	1.00	3.17	<15%	32/0	4	-ME
CFQ18W/G24q												
1	PRS	120 277	C218UNVDV3ME	0.20 0.09	23 22	>.90	1.00	4.55	<10%	32/0	3	-ME
2	PRS	120 277	C218UNVDV3ME	0.35 0.15	45 43	>.95	1.00	2.36	<10%	32/0	4	-ME
CFQ26W/G24q												
1	PRS	120 277	C226UNVDV3ME	0.25 0.11	31 29	>.95	1.00	2.00	<10%	32/0	3	-ME
2	PRS	120 277	C226UNVDV3ME	0.44 0.19	51 50	>.95	1.00	3.52	<10%	32/0	4	-ME
CFTR32W/G24q												
1	PRS	120 277	C226UNVDV3ME	0.26 0.12	32 33	>.95	1.00	3.10	<10%	32/0	3	-ME
2	PRS	120 277	C232PUNVDV3	0.58 0.26	71 70	>.95	1.00	1.41 1.43	<10%	0/-18	4	DP2
CFTR42W/G24q												
1	PRS	120 277	C226UNVDV3ME	0.43 0.19	47 45	>.95	1.00	2.13 2.22	<10%	0/-18	3	DP2
2	PRS	120 277	C242PUNVDV3	0.82 0.36	92 91	>.95	1.00	1.09 1.10	<10%	0/-18	4	DP2
FT40W/2G11												
1	PRS	120 277	C140PUNVDV3	0.37 0.16	45 44	>.95	1.00	2.22 2.27	<10%	0/-18	5	DP1
2	PRS	120 277	C240PUNVDV3	0.83 0.37	97 94	>.95	1.00	1.03 1.06	<10%	0/-18	6	DP1

* Consult Specification Sheets at www.unvlt.com for additional lamp applications

STARTING METHOD LEGEND

PAR-PRS = Parallel Programmed Start

See page 2-22 for Dimensions and Wiring Diagrams

DaliPRO® Premium DIMMING BALLASTS

PARALLEL LAMP

DaliPRO®
Premium
DIMMING

Lamp		Line Volts	Catalog Number	Line Current (Amps)	Input Power (Watts)	Power Factor (PF)	Ballast Factor (BF)	Ballast Efficacy Factor (BEF)	THD %	Min. F/C Start Temp	Wiring Diag.	Dim.
Qty.	Starting Method											
F1728												
1	PRS	120 277	B232PUDV3PLA	0.19 0.08	20 20	>.95	1.02	5.13	<10%	32/0	20	-A
1	PRS	120 277	B232PUDV3PLD	0.19 0.08	20 20	>.95	1.02	5.13	<10%	32/0	20	-D
1	PRS	347	B232P3DV3PLA	0.07	20	>.95	1.04	5.13	<20%	32/0	20	-A
1	PRS	347	B232P3DV3PLD	0.07	20	>.95	1.04	5.13	<20%	32/0	20	-D
2	PRS	120 277	B232PUDV3PLA	0.32 0.14	37 36	>.98	1.02	2.84	<10%	32/0	2	-A
2	PRS	120 277	B232PUDV3PLD	0.32 0.14	37 36	>.98	1.02	2.84	<10%	32/0	2	-D
2	PRS	347	B232P3DV3PLA	0.11	37	>.95	1.00	2.78	<10%	32/0	2	-A
2	PRS	347	B232P3DV3PLD	0.11	37	>.95	1.00	2.78	<10%	32/0	2	-D
F32T8* (also operates F28T8)												
1	PRS	120 277	B232PUDV3PLA	0.30 0.13	36 35	>.98	1.00	2.80	<10%	32/0	20	-A
1	PRS	120 277	B232PUDV3PLD	0.31 0.13	36 35	>.98	1.00	2.85	<10%	32/0	20	-D
1	PRS	347	B232P3DV3PLA	0.11	35	>.95	1.00	2.87	<10%	32/0	20	-A
1	PRS	347	B232P3DV3PLD	0.11	35	>.95	1.00	2.87	<10%	32/0	20	-D
2	PRS	120 277	B232PUDV3PLA	0.58 0.25	67 65	>.99	1.00	1.53	<10%	32/0	2	-A
2	PRS	120 277	B232PUDV3PLD	0.58 0.25	67 65	>.99	1.00	1.53	<10%	32/0	2	-D
2	PRS	347	B232P3DV3PLA	0.19	65	>.95	1.00	1.54	<10%	32/0	2	-A
2	PRS	347	B232P3DV3PLD	0.19	65	>.95	1.00	1.54	<10%	32/0	2	-D
F14T5 (also operates F21T5)												
1	PRS	120 277	B228PUDV3PLA	0.16 0.07	19 19	>.95	1.01	5.19	<10%	50/10	20	-A
1	PRS	120 277	B228PUDV3PLD	0.16 0.07	19 19	>.95	1.01	5.19	<10%	50/10	20	-D
1	PRS	347	B228P3DV3PLA	0.06	19	>.90	1.01	5.27	<20%	50/10	20	-A
1	PRS	347	B228P3DV3PLD	0.06	19	>.90	1.01	5.27	<10%	50/10	20	-D
2	PRS	120 277	B228PUDV3PLA	0.29 0.13	35 35	>.98	1.01	2.92	<10%	50/10	2	-A
2	PRS	120 277	B228PUDV3PLD	0.29 0.13	35 35	>.98	1.01	2.92	<10%	50/10	2	-D
2	PRS	347	B228P3DV3PLA	0.10	35	>.95	1.01	2.93	<10%	50/10	2	-A
2	PRS	347	B228P3DV3PLD	0.10	35	>.95	1.01	2.93	<10%	50/10	2	-D
F28T5 (also operates F28T5/ES)												
1	PRS	120 277	B228PUDV3PLA	0.30 0.13	35 34	>.98	1.00	2.95	<10%	50/10	20	-A
1	PRS	120 277	B228PUDV3PLD	0.29 0.12	35 34	>.98	1.00	2.95	<10%	50/10	20	-D
1	PRS	347	B228P3DV3PLA	0.10	34	>.95	1.00	2.94	<10%	50/10	20	-A
1	PRS	347	B228P3DV3PLD	0.10	34	>.95	1.00	2.94	<10%	50/10	20	-D
1	PRS	120 277	B228PUDV3PLA	0.56 0.24	62 61	>.99	1.00	1.63	<10%	50/10	2	-A
1	PRS	120 277	B228PUDV3PLD	0.56 0.24	62 61	>.99	1.00	1.63	<10%	50/10	2	-D
1	PRS	347	B228P3DV3PLA	0.19	64	>.98	1.00	1.57	<10%	50/10	2	-A
1	PRS	347	B228P3DV3PLD	0.19	64	>.98	1.00	1.57	<10%	50/10	2	-D
F54T5HO*												
1	PRS	120 277	B254PUDV3PLD	0.51 0.23	54 56	>.97	1.00	1.85	<10%	32/0	20	-D
1	PRS	347	B254P3DV3PLD	0.18	58	>.98	1.00	1.72	<10%	32/0	20	-D
2	PRS	120 277	B254PUDV3PLD	0.94 0.41	116 112	>.99	1.00	0.89	<10%	32/0	2	-D
2	PRS	347	B254P3DV3PLD	0.33	109	>.99	1.00	0.92	<10%	32/0	2	-D

* Consult Specification Sheets at www.unvlt.com for additional lamp applications

See page 2-22 for Dimensions
and Wiring Diagrams

STARTING METHOD LEGEND

PAR-PRS = Parallel Programmed Start

SuperDim® 0-10V DIMMING BALLASTS

Please visit www.unvlt.com for the most up to date status and recent changes to the SuperDim product family.

Qty.	Lamp		Line Volts	Catalog Number	Line Current (Amps)	Input Power (Watts)	Power Factor (PF)	Ballast Factor (BF)	THD %	Min. F/C Start Temp	Wiring Diag.	Dim.
	Starting Method											
F17T8												
1	PRS	120	B132PUNVSV3-A	0.13	16	> .97	0.85	<10	50/10	7	-A	
		277		0.06	16							
2	PRS	120	B232PUNVSV3-A	0.27	32	> .98	0.85	<10	50/10	8	-A	
		277		0.12	32							
F25T8												
1	PRS	120	B132PUNVSV3-A	0.18	22	> .98	0.85	<10	50/10	7	-A	
		277		0.08	22							
2	PRS	120	B232PUNVSV3-A	0.38	45	> .99	0.85	<10	50/10	8	-A	
		277		0.16	44							
F32T8												
1	PRS	120	B132PUNVSV3-A	0.25	30	> .99	0.88	<10	50/10	7	-A	
		277		0.11	30							
2	PRS	120	B232PUNVSV3-A	0.48	57	> .99	0.88	<10	50/10	8	-A	
		277		0.20	56							
F14T5												
1	PRS	120	B114PUNVSV3-D	0.14	17	> .97	1.00	<10	32/0	7	-D	
		277		0.06	17							
2	PRS	120	B214PUNVSV3-D	0.27	32	> .97	1.00	<10	32/0	8	-D	
		277		0.11	32							
F21T5												
1	PRS	120	B128PUNVSV3-D	0.27	25	> .95	1.01	<10	50/10	7	-D	
		277		0.12	25							
2	PRS	120	B228PUNVSV3-D	0.39	47	> .95	1.01	<10	50/10	8	-D	
		277		0.17	46							
F28T5												
1	PRS	120	B128PUNVSV3-D	0.21	32	> .99	1.00	<10	50/10	7	-D	
		277		0.10	32							
2	PRS	120	B228PUNVSV3-D	0.53	63	> .99	1.00	<10	50/10	8	-D	
		277		0.22	61							
F35T5												
1	PRS	120	B135PUNVSV3-D	0.33	40	> .99	1.00	<10	50/10	7	-D	
		277		0.14	39							
CFQ13W/G24q & CFTR13W/Gx24q												
1	PRS	120	C213UNVSV3ME	0.13	16	> .99	1.00	<15	32/0	9	C11	
		277		0.06	30							
2	PRS	120	C213UNVSV3ME	0.25	16	> .99	1.00	<10	32/0	10	C11	
		277		0.11	30							
CFQ18W/G24q & CFTR18W/Gx24q												
1	PRS	120	C218UNVSV3ME	0.17	20	> .99	1.00	<10	32/0	9	C11	
		277		0.08	20							
2	PRS	120	C218UNVSV3ME	0.33	39	> .99	1.00	<10	32/0	10	C11	
		277		0.15	38							
CFQ26W/G24q & CFTR26W/Gx24q												
1	PRS	120	C226UNVSV3ME	0.26	28	> .96	1.00	<10	32/0	9	C11	
		277		0.10	28							
2	PRS	120	C226UNVSV3ME	0.44	53	> .99	1.00	<10	32/0	10	C11	
		277		0.19	53							
CFTR32W/Gx24q												
1	PRS	120	C226UNVSV3ME	0.28	34	> .97	1.00	<10	32/0	9	C11	
		277		0.12	34							
CFTR42W/Gx24q												
1	PRS	120	C226UNVSV3ME	0.35	42	> .98	1.00	<10	32/0	9	C11	
		277		0.15	42							

STARTING METHOD LEGEND
PRS = Programmed Rapid Start

See page 2-22 for Dimensions and Wiring Diagrams

BallaSTAR® 0-10 VOLT DIMMING BALLASTS

FOR (1), (2), (3) & (4) T8 LAMPS

Please visit www.unvlt.com for the most up to date status and recent changes to the Ballastar 0-10V product family.

- Analog Dimming
- Rapid Start
- 1, 2, 3 & 4 Lamp Applications

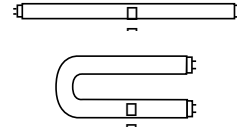

BallaStar®

0-10V
DIMMING

Lamp		Line Volts	Catalog Number	Line Current (Amps)	Input Power (Watts)	Power Factor (PF)	Ballast Factor (BF)	Ballast Efficacy Factor (BEF)	THD %	Min. F/C Start Temp	Wiring Diag.	Dim.
Qty.	Starting Method											
F25T8 - One Lamp Applications												
1		347	B132R347V5 @ 100%	0.08	26	> .99	0.90	3.46	< 10	50/10	7	ST
			B132R347V5 @ 5%	0.02	7	> .90	0.05	0.71	< 30	50/10	7	ST
F32T8 - One Lamp Applications												
1		347	B132R347V5 @ 100%	0.09	32	> .99	0.88	2.75	< 10	50/10	7	ST
			B132R347V5 @ 5%	0.02	8	> .90	0.05	0.63	< 20	50/10	7	ST
F32T8 - Two Lamp Applications												
2	RS	347	B232SR347V5 @ 100%	0.18	62	> .99	0.88	1.42	< 10	50/10	8	ST
			B232SR347V5 @ 5%	0.04	13	> .90	0.05	0.38	< 15	50/10	8	ST
		347	B232SR347V5 @ 100%	0.18	62	> .99	0.88	1.42	< 10	50/10	8	ST
			B232SR347V5 @ 5%	0.04	13	> .90	0.05	0.38	< 15	50/10	8	ST
F32T8 - Three Lamp Applications												
3	SER-RS	120	B332SR120V5 @ 100%	0.77	92	> .99	0.88	0.96	< 10	50/10	17	ST
			B332SR120V5 @ 5%	0.17	20	> .90	0.05	0.25	< 10	50/10	17	ST
		277	B332SR277V5 @ 100%	0.33	92	> .99	0.88	0.96	< 10	50/10	17	ST
			B332SR277V5 @ 5%	0.07	20	> .90	0.05	0.25	< 15	50/10	17	ST
F32T8 - Four Lamp Applications												
4	SER/PAR-RS	277	B432SR277V5 @ 100%	0.42	117	> .99	0.88	0.79	< 10	50/10	16	-ZZ
			B432SR277V5 @ 5%	0.11	27	> .90	0.05	0.19	< 15	50/10	16	-ZZ

All models except B232SR347V5 are cULus Listed
B232SR347V5 is CSA Certified

See page 2-22 for Dimensions
and Wiring Diagrams

IS = Instant Start
PRS = Programmed Rapid Start
RS = Rapid Start

STARTING METHOD LEGEND
PAR-IS = Parallel Instant Start
PAR-PRS = Parallel Programmed Rapid Start

PAR-RS = Parallel Rapid Start
SER-RS = Series Rapid Start

Fluorescent Dimming

BallaSTAR® STEP DIMMING BALLASTS FOR (1), (2) & (3) T8 LAMPS

- Step Dimming
- Rapid Start
- 1-3 Lamp Applications

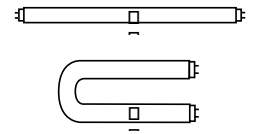

Lamp Qty.		Starting Method	Line Volts	Catalog Number	Line Current (Amps)	Input Power (Watts)	Power Factor (PF)	Ballast Factor (BF)	Ballast Efficacy Factor (BEF)	THD %	Min. F/C Start Temp	Wiring Diag.	Dim.
F17T8 - One Lamp Applications													
1	PRS	120	B232PUS50-A @ 100%	0.14	16	> .95	0.88	5.50	< 15	32/0	11	-A	
			B232PUS50-A @ 50%	0.08	9	> .95	0.29	3.22	< 15	32/0	11	-A	
		277	B232PUS50-A @ 100%	0.08	16	> .70	0.88	5.50	< 15	32/0	11	-A	
			B232PUS50-A @ 50%	0.05	9	> .70	0.29	3.22	< 15	32/0	11	-A	
F17T8 - Two Lamp Applications													
2	PRS	120	B232PUS50-A @ 100%	0.25	30	> .99	0.87	2.90	< 10	32/0	12	-A	
			B232PUS50-A @ 50%	0.14	16	> .98	0.30	1.88	< 15	32/0	12	-A	
		277	B232PUS50-A @ 100%	0.12	30	> .88	0.87	2.90	< 10	32/0	12	-A	
			B232PUS50-A @ 50%	0.07	16	> .85	0.30	1.88	< 15	32/0	12	-A	
F25T8 - One Lamp Applications													
1	RS	120	B232PUS50-A @ 100%	0.21	24	> .95	0.85	3.54	< 10	32/0	11	-A	
			B232PUS50-A @ 50%	0.10	12	> .90	0.28	2.33	< 10	32/0	11	-A	
		277	B232PUS50-A @ 100%	0.11	24	> .80	0.85	3.54	< 10	32/0	11	-A	
			B232PUS50-A @ 50%	0.06	12	> .80	0.28	2.33	< 10	32/0	11	-A	
F25T8 - Two Lamp Applications													
2	SER-RS	120	B232PUS50-A @ 100%	0.39	46	> .98	0.84	1.83	< 10	32/0	12	-A	
			B232PUS50-A @ 50%	0.20	24	> .95	0.28	1.17	< 10	32/0	12	-A	
		277	B232PUS50-A @ 100%	0.18	46	> .98	0.84	1.83	< 10	32/0	12	-A	
			B232PUS50-A @ 50%	0.09	24	> .90	0.28	1.17	< 10	32/0	12	-A	
F32T8 - One Lamp Applications													
1	RS	120	B232PUS50-A @ 100%	0.25	29	> .99	0.88	3.03	< 10	32/0	11	-A	
			B232PUS50-A @ 50%	0.12	14	> .98	0.29	2.07	< 10	32/0	11	-A	
		277	B232PUS50-A @ 100%	0.12	29	> .85	0.88	3.03	< 10	32/0	11	-A	
			B232PUS50-A @ 50%	0.06	14	> .80	0.29	2.07	< 20	32/0	11	-A	
F32T8 - Two Lamp Applications													
2	SER-RS	120	B232SR120S30 @ 100%	0.52	62	> .99	0.88	1.42	< 10	50/10	12	ST	
			B232SR120S30 @ 60%	0.38	45	> .95	0.58	1.29	< 10	50/10	12	ST	
			B232SR120S30 @ 30%	0.24	28	> .95	0.27	0.96	< 10	50/10	12	ST	
			B232SR277S30 @ 100%	0.23	62	> .99	0.88	1.42	< 10	50/10	12	ST	
			B232SR277S30 @ 60%	0.17	45	> .95	0.58	1.29	< 10	50/10	12	ST	
			B232SR277S30 @ 30%	0.11	28	> .95	0.27	0.96	< 10	50/10	12	ST	
		277	B232PUS50-A @ 100%	0.48	57	> .99	0.88	1.54	< 10	32/0	12	-A	
			B232PUS50-A @ 50%	0.24	28	> .99	0.30	1.07	< 10	32/0	12	-A	
			B232PUS50-A @ 100%	0.21	56	> .95	0.88	1.57	< 10	32/0	12	-A	
			B232PUS50-A @ 50%	0.11	28	> .90	0.30	1.07	< 10	32/0	12	-A	
F32T8 - Three Lamp Applications													
3	SER-RS	120	B332SR120S30 @ 100%	0.78	93	> .99	0.88	0.95	< 10	50/10	15	ST	
			B332SR120S30 @ 60%	0.61	69	> .95	0.60	0.87	< 10	50/10	15	ST	
			B332SR120S30 @ 30%	0.40	43	> .95	0.30	0.70	< 10	50/10	15	ST	
		277	B332SR277S30 @ 100%	0.34	94	> .99	0.88	0.94	< 10	50/10	15	ST	
			B332SR277S30 @ 60%	0.26	69	> .95	0.60	0.87	< 10	50/10	15	ST	
			B332SR277S30 @ 30%	0.16	43	> .95	0.30	0.70	< 10	50/10	15	ST	

All models are cULus Listed

See page 2-22 for Dimensions and Wiring Diagrams

BallaSTAR® STEP DIMMING BALLASTS FOR T5 LAMPS

- Step Dimming
- Programmed Rapid Start
- 2 Lamp Applications

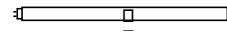

BALLASTAR

LIGHT LEVEL
SWITCHING

Lamp		Line Volts	Catalog Number	Line Current (Amps)	Input Power (Watts)	Power Factor (PF)	Ballast Factor (BF)	Ballast Efficacy Factor (BEF)	THD %	Min. F/C Start Temp	Wiring Diag.	Dim.
Qty.	Starting Method											
F14T5 - Lamp Applications												
1	PRS	120	B214PU115S50A @ 100%	0.17	21	> .95	1.19	5.90	< 15	50/10	11	-A
			B214PU115S50A @ 50%	0.09	10	> .95	0.40	3.74	< 15	50/10	11	-A
		277	B214PU115S50A @ 100%	0.09	21	> .75	1.19	5.80	< 15	50/10	11	-A
			B214PU115S50A @ 50%	0.05	10	> .75	0.40	3.50	< 15	50/10	11	-A
2	PRS	120	B214PU115S50A @ 100%	0.33	37.5	> .95	1.15	3.10	< 10	50/10	12	-A
			B214PU115S50A @ 50%	0.15	18	> .95	0.40	2.19	< 15	50/10	12	-A
		277	B214PU115S50A @ 100%	0.15	37	> .90	1.15	3.11	< 10	50/10	12	-A
			B214PU115S50A @ 50%	0.08	19	> .85	0.40	2.14	< 15	50/10	12	-A
2	PRS	120	B228PU95S50D @ 100%	0.29	35	> .95	1.00	2.86	< 10	50/10	14	-D
			B228PU95S50D @ 50%	0.13	16	> .95	0.37	2.30	< 10	50/10	14	-D
		277	B228PU95S50D @ 100%	0.13	35	> .95	1.00	2.86	< 10	50/10	14	-D
			B228PU95S50D @ 50%	0.06	16	> .90	0.37	2.29	< 10	50/10	14	-D
F21T5 - Lamp Applications												
1	PRS	120	B214PU115S50A @ 100%	0.24	29	> .95	1.18	4.09	< 10	50/10	11	-A
			B214PU115S50A @ 50%	0.12	14	> .95	0.39	2.84	< 15	50/10	11	-A
		277	B214PU115S50A @ 100%	0.12	29	> .85	1.18	4.06	< 15	50/10	11	-A
			B214PU115S50A @ 50%	0.62	14	> .85	0.40	2.75	< 15	50/10	11	-A
2	PRS	120	B228PU95S50D @ 100%	0.40	48	> .95	0.99	2.06	< 10	50/10	14	-D
			B228PU95S50D @ 50%	0.18	21	> .95	0.36	1.73	< 10	50/10	14	-D
		277	B228PU95S50D @ 100%	0.17	47	> .95	0.99	2.10	< 10	50/10	14	-D
			B228PU95S50D @ 50%	0.08	22	> .95	0.36	1.65	< 10	50/10	14	-D
F28T5 - Lamp Applications												
1	PRS	120	B214PU115S50A @ 100%	0.32	38	> .95	1.15	3.02	< 10	50/10	11	-A
			B214PU115S50A @ 50%	0.16	19	> .95	0.45	2.37	< 15			
		277	B214PU115S50A @ 100%	0.15	38	> .90	1.15	3.07	< 10	50/10	11	-A
			B214PU115S50A @ 50%	0.08	19	> .85	0.43	2.23	< 15			
2	PRS	120	B228PU95S50D @ 100%	0.50	58	> .99	0.95	1.64	< 10	50/10	14	-D
			B228PU95S50D @ 50%	0.23	28	> .99	0.35	1.25	< 20			
		277	B228PU95S50D @ 100%	0.21	57	> .98	0.95	1.67	< 10	50/10	14	-D
			B228PU95S50D @ 50%	0.10	28	> .95	0.35	1.25	< 20			
2	PRS	120	B228PU115S50D @ 100%	0.59	71	> .99	1.15	1.62	< 10	50/10	14	-D
			B228PU115S50D @ 50%	0.29	34	> .99	0.45	1.32	< 10			
		277	B228PU115S50D @ 100%	0.25	69	> .98	1.15	1.67	< 10	50/10	14	-D
			B228PU115S50D @ 50%	0.12	34	> .95	0.45	1.32	< 15			

° Preliminary Data

All models are cULus Listed

See page 2-22 for Dimensions and Wiring Diagrams

STARTING METHOD LEGEND

IS = Instant Start
 PRS = Programmed Rapid Start
 RS = Rapid Start

PAR-IS = Parallel Instant Start
 PAR-PRS = Parallel Programmed Rapid Start

PAR-RS = Parallel Rapid Start
 SER-RS = Series Rapid Start

Fluorescent Dimming

Overall Dimensions		Mounting Dimensions			
Draw #	L	W	H	M	X
-A	9.50"	1.70"	1.18"	8.89"	—
-D	16.88"	1.18"	1.00"	16.20"	—
-C11	4.94"	3.00"	1.00"	4.61"	—
ST	9.50"	2.40"	1.55"	8.89"	1.69"
-ZZ	16.40"	2.40"	1.50"	15.88"	1.69"
DP1	18.00"	1.18"	1.18"	17.70"	—
DP2	4.95"	2.93"	1.38"	4.57"	—

Note: Nominal dimensions provided above
Contact Universal for drawings and/or tolerances

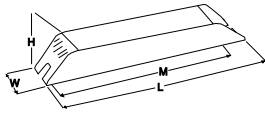

-D, DP1

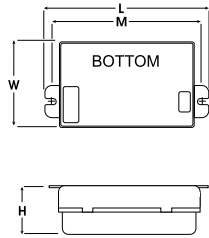

C11, DP2

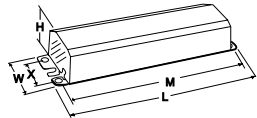

-A, ST, -ZZ

WIRING DIAGRAMS

Ballast case must be grounded. A star washer or other paint penetrating device is required

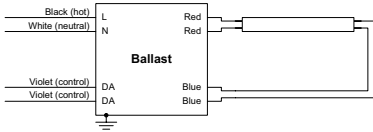

DIAGRAM 1

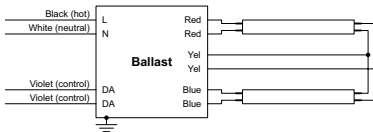

DIAGRAM 2

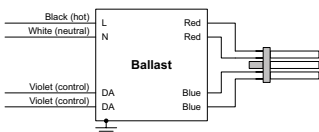

DIAGRAM 3

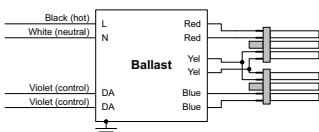

DIAGRAM 4

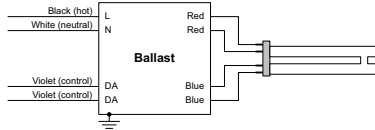

DIAGRAM 5

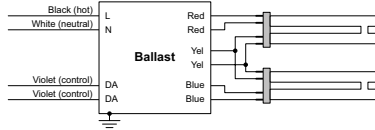

DIAGRAM 6

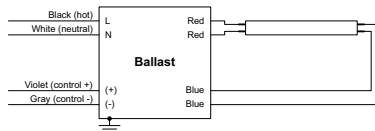

DIAGRAM 7

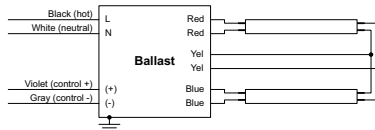

DIAGRAM 8

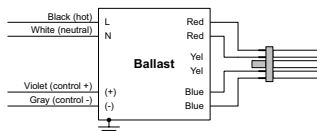

DIAGRAM 9

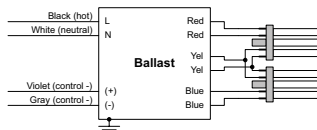

DIAGRAM 10

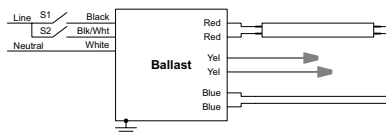

DIAGRAM 11

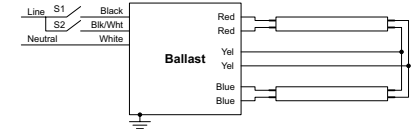

DIAGRAM 12

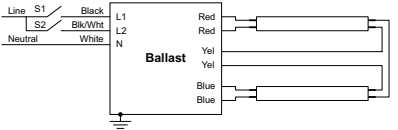

DIAGRAM 14

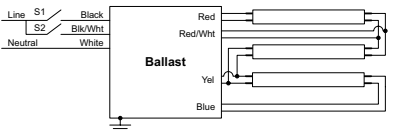

DIAGRAM 15

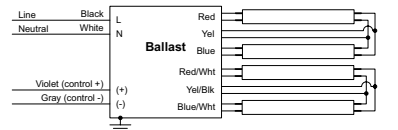

DIAGRAM 16

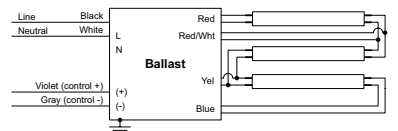

DIAGRAM 17

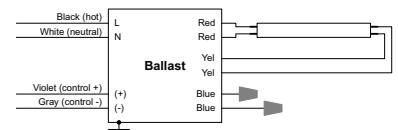

DIAGRAM 18

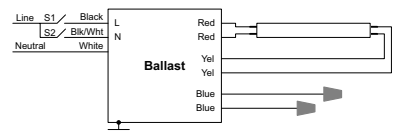

DIAGRAM 19

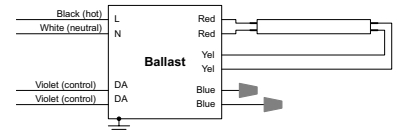

DIAGRAM 20

VariPRO DIMMING BALLASTS

PARALLEL LAMP

Lamp Qty.	Starting Method	Line Volts	Catalog Number	Line Current (Amps)	Input Power (Watts)	Power Factor (PF)	Ballast Factor (BF)	THD %	Min. F/C Start Temp ¹	Wiring Diag.	Dim.
F17T8											
1	PRS	120	B232PUSV3PLA	0.15	17	0.90	0.87	< 19	32/0	18	-A
		277	B232PUSV3PLA	0.07	17						
		347	B232P3SV3PLA	0.06	17						
2	PRS	120	B232PUSV3PLA	0.27	32	0.96	0.87	< 12	32/0	8	-A
		277	B232PUSV3PLA	0.11	31						
		347	B232P3SV3PLA	0.09	31						
F25T8											
1	PRS	120	B232PUSV3PLA	0.15	24	0.94	0.87	< 15	32/0	18	-A
		277	B232PUSV3PLA	0.09	23						
		347	B232P3SV3PLA	0.07	23						
2	PRS	120	B232PUSV3PLA	0.36	45	0.98	0.87	< 10	32/0	8	-A
		277	B232PUSV3PLA	0.15	44						
		347	B232P3SV3PLA	0.12	44						
F32T8											
1	PRS	120	B232PUSV3PLA	0.26	31	0.96	0.88	< 12	32/0	18	-A
		277	B232PUSV3PLA	0.11	30						
		347	B232P3SV3PLA	0.09	30						
2	PRS	120	B232PUSV3PLA	0.48	57	0.98	0.87	< 10	32/0	8	-A
		277	B232PUSV3PLA	0.21	57						
		347	B232P3SV3PLA	0.16	57						
F40T8											
1	PRS	120	B232PUSV3PLA	0.31	38	0.97	0.87	< 10	32/0	18	-A
		277	B232PUSV3PLA	0.13	37						
		347	B232P3SV3PLA	0.11	37						
2	PRS	120	B232PUSV3PLA	0.59	71	0.99	0.87	< 10	32/0	8	-A
		277	B232PUSV3PLA	0.25	70						
		347	B232P3SV3PLA	0.20	70						
F32T8 (30W)											
1	PRS	120	B232PUSV3PLA	0.25	30	0.95	0.87	< 12	60/15	18	-A
		277	B232PUSV3PLA	0.11	29						
		347	B232P3SV3PLA	0.09	29						
2	PRS	120	B232PUSV3PLA	0.46	55	0.98	0.87	< 10	60/15	8	-A
		277	B232PUSV3PLA	0.19	54						
		347	B232P3SV3PLA	0.16	54						
F28T8											
1	PRS	120	B232PUSV3PLA	0.22	26	0.94	0.87	< 14	60/15	18	-A
		277	B232PUSV3PLA	0.09	26						
		347	B232P3SV3PLA	0.09	26						
2	PRS	120	B232PUSV3PLA	0.40	49	0.98	0.87	< 10	60/15	8	-A
		277	B232PUSV3PLA	0.17	48						
		347	B232P3SV3PLA	0.14	48						
F30T8 (25W)											
1	PRS	120	B232PUSV3PLA	0.20	24	0.94	0.87	< 15	60/15	18	-A
		277	B232PUSV3PLA	0.09	23						
		347	B232P3SV3PLA	0.07	23						
2	PRS	120	B232PUSV3PLA	0.37	45	0.98	0.87	< 10	60/15	8	-A
		277	B232PUSV3PLA	0.16	44						
		347	B232P3SV3PLA	0.13	44						

¹ A short stabilization period may be needed for temperatures below 10C

See page 2-22 for Dimensions and Wiring Diagrams

Fluorescent Dimming

Lamp Qty.	Starting Method	Line Volts	Catalog Number	Line Current (Amps)	Input Power (Watts)	Power Factor (PF)	Ballast Factor (BF)	THD %	Min. F/C Start Temp ¹	Wiring Diag.	Dim.
F14T5											
1	PRS	120	B228PUSV3PLA	0.17	19	0.93	1.00	< 17	50/10	18	-A
		277	B228PUSV3PLA	0.07	18						
		347	B228P3SV3PLA	0.06	19						
2	PRS	120	B228PUSV3PLA	0.30	34	0.97	1.00	< 10	50/10	8	-A
		277	B228PUSV3PLA	0.13	33						
		347	B228P3SV3PLA	0.11	34						
F21T5											
1	PRS	120	B228PUSV3PLA	0.23	26	0.95	1.00	< 13	50/10	18	-A
		277	B228PUSV3PLA	0.10	25						
		347	B228P3SV3PLA	0.09	26						
2	PRS	120	B228PUSV3PLA	0.42	48	0.98	1.00	< 10	50/10	8	-A
		277	B228PUSV3PLA	0.18	47						
		347	B228P3SV3PLA	0.15	47						
F28T5											
1	PRS	120	B228PUSV3PLA	0.29	33	0.97	1.00	< 10	50/10	18	-A
		277	B228PUSV3PLA	0.13	33						
		347	B228P3SV3PLA	0.11	34						
2	PRS	120	B228PUSV3PLA	0.56	64	0.99	1.00	< 10	50/10	8	-A
		277	B228PUSV3PLA	0.24	63						
		347	B228P3SV3PLA	0.19	63						
F28T5ES (25W)											
1	PRS	120	B228PUSV3PLA	0.27	31	0.96	1.00	< 12	60/15	18	-A
		277	B228PUSV3PLA	0.12	31						
		347	B228P3SV3PLA	0.09	30						
2	PRS	120	B228PUSV3PLA	0.51	59	0.99	1.00	< 10	60/15	8	-A
		277	B228PUSV3PLA	0.22	57						
		347	B228P3SV3PLA	0.17	58						

¹ A short stabilization period may be needed for temperatures below 10C

See page 2-22 for Dimensions and Wiring Diagrams

VariPRO DIMMING BALLASTS

PARALLEL LAMP

Lamp Qty.	Starting Method	Line Volts	Catalog Number	Line Current (Amps)	Input Power (Watts)	Power Factor (PF)	Ballast Factor (BF)	THD %	Min. F/C Start Temp ¹	Wiring Diag.	Dim.
F54T5HO											
1	PRS	120	B254PUSV3PLD	0.46	54	0.97	1.00	< 10	32/0	18	-D
		277	B254PUSV3PLD	0.21	56						
		347	B254P3SV3PLD	0.18	58						
2	PRS	120	B254PUSV3PLD	0.98	116	0.99	1.00	< 10	32/0	8	-D
		277	B254PUSV3PLD	0.42	112						
		347	B254P3SV3PLD	0.33	109						
F54T5HOES (49W)											
1	PRS	120	B254PUSV3PLD	0.44	52	0.96	1.00	< 10	60/15	18	-D
		277	B254PUSV3PLD	0.20	53						
		347	B254P3SV3PLD	0.16	54						
2	PRS	120	B254PUSV3PLD	0.86	102	0.99	1.00	< 10	60/15	8	-D
		277	B254PUSV3PLD	0.38	101						
		347	B254P3SV3PLD	0.30	101						
FT55W/2G11											
1	PRS	120	B254PUSV3PLD	0.47	58	0.97	0.90	< 10	60/15	18	-D
		277	B254PUSV3PLD	0.21	58						
		347	B254P3SV3PLD	0.17	57						
2	PRS	120	B254PUSV3PLD	0.89	109	0.99	0.90	< 10	60/15	8	-D
		277	B254PUSV3PLD	0.38	105						
		347	B254P3SV3PLD	0.31	108						
FC55T5HO											
1	PRS	120	B254PUSV3PLD	0.45	54	0.96	0.90	< 10	60/15	18	-D
		277	B254PUSV3PLD	0.19	53						
		347	B254P3SV3PLD	0.16	56						
2	PRS	120	B254PUSV3PLD	0.86	105	0.98	0.90	< 10	60/15	8	-D
		277	B254PUSV3PLD	0.37	103						
		347	B254P3SV3PLD	0.30	105						

¹ A short stabilization period may be needed for temperatures below 10C

See page 2-22 for Dimensions and Wiring Diagrams

Lamp		Line Volts	Catalog Number	Line Current (Amps)	Input Power (Watts)	Power Factor (PF)	Ballast Factor (BF)	THD %	Min. F/C Start Temp ¹	Wiring Diag.	Dim.
Qty.	Starting Method										
F17T8											
1	PRS	120	B232PUS50PLHA	0.19	23	0.96	1.15	< 15	32/0	19	-A
		277	B232PUS50PLHA	0.08	23						
		347	B232P3S50PLHA	0.07	22						
2	PRS	120	B232PUS50PLHA	0.35	42	0.98	1.15	< 10	32/0	12	-A
		277	B232PUS50PLHA	0.15	41						
		347	B232P3S50PLHA	0.12	41						
F25T8											
1	PRS	120	B232PUS50PLHA	0.27	32	0.97	1.15	< 10	32/0	19	-A
		277	B232PUS50PLHA	0.12	32						
		347	B232P3S50PLHA	0.09	31						
2	PRS	120	B232PUS50PLHA	0.50	60	0.99	1.15	< 10	32/0	12	-A
		277	B232PUS50PLHA	0.21	59						
		347	B232P3S50PLHA	0.17	59						
F32T8											
1	PRS	120	B232PUS50PLHA	0.34	40	0.98	1.15	< 10	32/0	19	-A
		277	B232PUS50PLHA	0.15	40						
		347	B232P3S50PLHA	0.12	39						
2	PRS	120	B232PUS50PLHA	0.64	77	0.99	1.15	< 10	32/0	12	-A
		277	B232PUS50PLHA	0.27	75						
		347	B232P3S50PLHA	0.22	75						
F32T8 (30W)											
1	PRS	120	B232PUS50PLHA	0.32	38	0.98	1.15	< 10	60/15	19	-A
		277	B232PUS50PLHA	0.14	38						
		347	B232P3S50PLHA	0.11	38						
2	PRS	120	B232PUS50PLHA	0.60	72	0.99	1.15	< 10	60/15	12	-A
		277	B232PUS50PLHA	0.25	70						
		347	B232P3S50PLHA	0.20	69						
F28T8											
1	PRS	120	B232PUS50PLHA	0.28	34	0.98	1.15	< 10	60/15	19	-A
		277	B232PUS50PLHA	0.12	33						
		347	B232P3S50PLHA	0.10	33						
2	PRS	120	B232PUS50PLHA	0.54	65	0.99	1.15	< 10	60/15	12	-A
		277	B232PUS50PLHA	0.23	63						
		347	B232P3S50PLHA	0.18	63						
F30T8 (25W)											
1	PRS	120	B232PUS50PLHA	0.27	32	0.97	1.15	< 10	60/15	19	-A
		277	B232PUS50PLHA	0.12	32						
		347	B232P3S50PLHA	0.09	31						
2	PRS	120	B232PUS50PLHA	0.50	60	0.99	1.15	< 10	60/15	12	-A
		277	B232PUS50PLHA	0.21	59						
		347	B232P3S50PLHA	0.17	59						

¹ A short stabilization period may be needed for temperatures below 10C

See page 2-22 for Dimensions and Wiring Diagrams

LevelPRO DIMMING BALLASTS

LIGHT-LEVEL SWITCHING PARALLEL LAMP

Lamp Qty.	Starting Method	Line Volts	Catalog Number	Line Current (Amps)	Input Power (Watts)	Power Factor (PF)	Ballast Factor (BF)	THD %	Min. F/C Start Temp ¹	Wiring Diag.	Dim.
F17T8											
1	PRS	120	B232PUS50PLA	0.15	17	0.94	0.87	< 19	32/0	19	-A
		277	B232PUS50PLA	0.06	17						
		347	B232P3S50PLA	0.05	17						
2	PRS	120	B232PUS50PLA	0.26	31	0.97	0.87	< 10	32/0	12	-A
		277	B232PUS50PLA	0.11	31						
		347	B232P3S50PLA	0.09	31						
F25T8											
1	PRS	120	B232PUS50PLA	0.21	25	0.96	0.87	< 14	32/0	19	-A
		277	B232PUS50PLA	0.09	25						
		347	B232P3S50PLA	0.07	25						
2	PRS	120	B232PUS50PLA	0.38	46	0.98	0.87	< 10	32/0	12	-A
		277	B232PUS50PLA	0.16	44						
		347	B232P3S50PLA	0.13	44						
F32T8											
1	PRS	120	B232PUS50PLA	0.26	31	0.97	0.88	< 11	32/0	19	-A
		277	B232PUS50PLA	0.11	31						
		347	B232P3S50PLA	0.09	31						
2	PRS	120	B232PUS50PLA	0.48	59	0.99	0.87	< 10	32/0	12	-A
		277	B232PUS50PLA	0.21	58						
		347	B232P3S50PLA	0.17	58						
F40T8											
1	PRS	120	B232PUS50PLA	0.32	39	0.98	0.87	< 10	32/0	19	-A
		277	B232PUS50PLA	0.14	38						
		347	B232P3S50PLA	0.11	38						
2	PRS	120	B232PUS50PLA	0.61	74	0.99	0.87	< 10	32/0	12	-A
		277	B232PUS50PLA	0.26	72						
		347	B232P3S50PLA	0.21	72						
F32T8 (30W)											
1	PRS	120	B232PUS50PLA	0.24	29	0.97	0.87	< 12	60/15	19	-A
		277	B232PUS50PLA	0.10	29						
		347	B232P3S50PLA	0.08	29						
2	PRS	120	B232PUS50PLA	0.46	56	0.99	0.87	< 10	60/15	12	-A
		277	B232PUS50PLA	0.19	54						
		347	B232P3S50PLA	0.16	54						
F28T8											
1	PRS	120	B232PUS50PLA	0.22	26	0.96	0.87	< 14	60/15	19	-A
		277	B232PUS50PLA	0.09	26						
		347	B232P3S50PLA	0.08	25						
2	PRS	120	B232PUS50PLA	0.41	49	0.99	0.87	< 10	60/15	12	-A
		277	B232PUS50PLA	0.17	48						
		347	B232P3S50PLA	0.14	48						

Fluorescent Dimming

¹ A short stabilization period may be needed for temperatures below 10C

See page 2-22 for Dimensions and Wiring Diagrams

See page 2-20 for Dimensions and Wiring Diagrams

LevelPRO DIMMING BALLASTS

LIGHT-LEVEL SWITCHING PARALLEL LAMP

Lamp		Line Volts	Catalog Number	Line Current (Amps)	Input Power (Watts)	Power Factor (PF)	Ballast Factor (BF)	THD %	Min. F/C Start Temp ¹	Wiring Diag.	Dim.
Qty.	Starting Method										
F30T8 (25W)											
1	PRS	120	B232PUS50PLA	0.21	25	0.96	0.87	< 14	60/15	19	-A
		277	B232PUS50PLA	0.09	25						
		347	B232P3S50PLA	0.07	25						
2	PRS	120	B232PUS50PLA	0.38	46	0.98	0.87	< 10	60/15	12	-A
		277	B232PUS50PLA	0.16	44						
		347	B232P3S50PLA	0.13	44						
F14T5											
1	PRS	120	B232PUS50PLA	0.16	19	0.94	1.00	< 17	50/10	19	-A
		277	B232PUS50PLA	0.07	19						
		347	B232P3S50PLA	0.06	19						
2	PRS	120	B232PUS50PLA	0.30	34	0.98	1.00	< 10	50/10	12	-A
		277	B232PUS50PLA	0.13	34						
		347	B232P3S50PLA	0.10	34						
F21T5											
1	PRS	120	B232PUS50PLA	0.23	26	0.96	1.00	< 12	50/10	19	-A
		277	B232PUS50PLA	0.10	26						
		347	B232P3S50PLA	0.08	26						
2	PRS	120	B232PUS50PLA	0.42	49	0.99	1.00	< 10	50/10	12	-A
		277	B232PUS50PLA	0.18	48						
		347	B232P3S50PLA	0.14	48						
F28T5											
1	PRS	120	B232PUS50PLA	0.29	34	0.97	1.00	< 10	50/10	19	-A
		277	B232PUS50PLA	0.12	33						
		347	B232P3S50PLA	0.10	33						
2	PRS	120	B232PUS50PLA	0.56	65	0.99	1.00	< 10	50/10	12	-A
		277	B232PUS50PLA	0.24	63						
		347	B232P3S50PLA	0.19	63						
F28T5ES (25W)											
1	PRS	120	B232PUS50PLA	0.26	30	0.97	1.00	< 12	60/15	19	-A
		277	B232PUS50PLA	0.11	30						
		347	B232P3S50PLA	0.09	29						
2	PRS	120	B232PUS50PLA	0.51	59	0.97	1.00	< 10	60/15	12	-A
		277	B232PUS50PLA	0.25	58						
		347	B232P3S50PLA	0.17	58						

¹ A short stabilization period may be needed

See page 2-22 for Dimensions
and Wiring Diagrams

Notes

Compact Fluorescent Ballasts

The Courage To Dream Small

Universal Lighting Technologies (“Universal”) offers a full range of electronic programmed start compact fluorescent ballasts to address most commercial applications.

Our electronic models offer high efficiency for maximum energy savings and installer-friendly universal input voltage, which reduces your inventory and ensures that you have the right voltage ballast every time. A complete range of 347 volt models are also available that offer outstanding reliability and lamp performance. These models feature a low profile case that fits in any fixture. And their metal housing construction meets all plenum codes and delivers maximum heat transfer to extend ballast life.



Our compact fluorescent models offer installer-friendly universal input voltage.

Product Overview

Triad® Electronic CFL Ballasts:

- High efficiency for maximum energy savings.
- Universal input voltage of 120-277V. Installer friendly universal input voltage, which reduces inventory and ensures that you have the right voltage ballast every time.
- Complete range of 347 volt CFL models that offer outstanding reliability and lamp performance.
- Programmed Rapid Start (PRS) incorporated. PRS is recommended by all lamp manufacturers. Increases lamp life for those frequently switched applications where occupancy sensors are used. Meets all requirements of rapid start specs and more.
- Metal can construction. Metal housing construction meets all plenum codes and construction code requirements. It also delivers maximum heat transfer to extend ballast life. Designed and manufactured for long life.
- Meets all applicable regulatory and safety standards. ANSI C82.11 Ballast Specification, UL 935, FCC Part 18 (Class A), and UL2043 suitable for Air Handling spaces.
- 1- or 2- lamp operation of multiple lamp applications. Multiple lamp options on each ballast for added versatility in applications.
- THD<10%
- Type CC and Type HL (hazardous locations) rated. Type CC is an anti-arcing feature that is used to reduce arcing caused by loose connections or improper lamp-pin to lampholder contact. The Type CC feature senses this arcing and shuts down the ballast to prevent damage.
- Dual entry color coded wire trap terminals. For wiring accuracy and ease of installation.
- Low profile form case fits in any fixture. Use for surface or junction box mounting. Small size means less wasted space than full alternative.
- End of lamp life shutdown circuit. Meets ANSI/NEMA requirements. Allows you to replace failed lamps without turning off power.
- 75° C Temperature Test point. Maximum Case Temperature of 75° C allows for easy ballast/fixture testing, assuring proper temperature application.
- Lamp proximity. Lamps can be mounted in close proximity to these ballasts due to no temperature critical components near the can sides. And, their circuit board potting enhances reliability by lowering case temperatures.
- Warranty. Backed by Triad® five year warranty.

CFL Replacement Kits

The multi-exit ballast lead wire connectors accommodate side and bottom lead exit requirements. The snap mount adapter plate adds bottom-exit studs and additional flexibility for replacement of older magnetic ballasts. They also fit virtually every j-box cover and fixture application. This product is for distribution sale only.

Multi-E Kit products:

C213UNVME000K	C213/347ME001K
C218UNVME000K	C218/347ME001K
C2642UNVME000K	C2642/347ME001K

Multi-E Kit contains:

- Multi-exit ballast for use in both side-exit and bottom-exit replacement applications.
- Snap-mount adapter plate speeds up installation time. No hardware required for attaching snap-mount adapter plate.
- Lead wire set
- Wire extraction tool
- Instructions

Understanding Compact Fluorescent Technology

Compact fluorescent (CFL) lamps are single-ended and plug into sockets. They're sometimes referred to as "single-based" or "single-ended" fluorescent lamps.

Lamp Shapes

Today's CFL lamps come in these basic shapes: twin tube, quad, triple, multi, square and circular. Each of these shapes has its own subset of sizes. For example, the twin tube may range from 4' long (5 watt) to 22' long (40 watt).

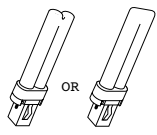

Twin, 2-Pin
5w - 13w

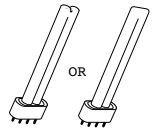

Long Twin T5, 4-Pin
5w - 80w

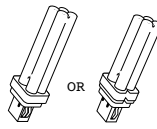

2-Pin 4-Pin
Quad 9w - 27w

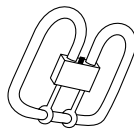

Square (2D)
10w - 55w

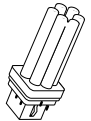

Multiple, 4-Pin
(GE & OS)
18w - 70w

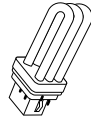

Multiple, 4-Pin
(Philips)
18w - 42w

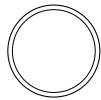

T5 Circular
22w - 55w

Pins and Starters

CFL lamps feature either two pins or four pins.

Four-pin lamps are traditionally powered by electronic ballasts. These lamps do not have an internal starter, so the other filament terminals (pins) are made accessible for external connection to the ballasts.

Lamp Bases

There are a variety of lamp bases used with today's CFL lamps. This provides a safeguard to make sure that the proper lamp/ballast combination is installed. The lamp base style is part of the ANSI/NEMA designation.

In this catalog, Universal CFL ballasts are classified according to lamp type. Icons representing each lamp type provide a quick visual reference. Within each classification, the lamps and their appropriate ballasts can be found by referring to the generic NEMA lamp descriptions.

Lamp Designation

There are two different industry-recognized nomenclatures for identifying CFL lamps: ANSI Lamp Designations and NEMA Lamp Designations. Here are examples of each:

ANSI Designation

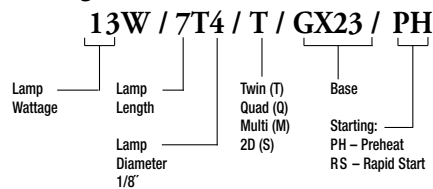

NEMA Designation

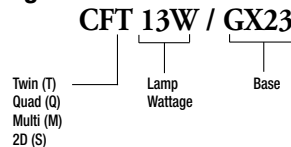

Both lamp designations refer to lamp wattage, shape, and base type. Since the NEMA designation is shorter, it will probably be the nomenclature of choice in the future. All of the major lamp companies have trade names for various CFL lamp types, such as GE's "Biax" and "2D" lamps, OSI's "Dulux," and Philips' "PL." These names have become more widely used than either of the industry designations.

Industry	Watts	GE	OSI	Philips
Single or Twin	5, 7, 9, 13	Low Watt Biax	Dulux S, S/E	PL-S
Double or Quad	9, 13, 18, 20, 26, 27	Double Biax	Dulux D, D/E	PL-C
Multiple	13, 18, 26, 32, 42	Biax T/E	Dulux T, T/E, T/E/IN	PL-T
Multiple	42, 57, 70	Biax Q/E	Dulux T/E/IN	PL-T
Long Twin T5	18, 24/27, 36/39, 40, 50, 80	High Lumen Biax	Dulux L, F	PL-L
Square	10, 16, 21, 28, 38, 55	2D	—	—
Circline	22, 40, 55	—	Pentron	Silhouette

Configurations

Electronic Bottom Exit (BE)

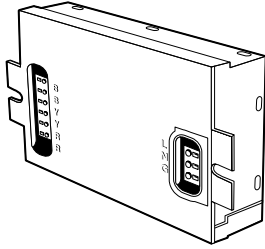



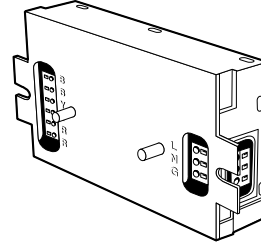



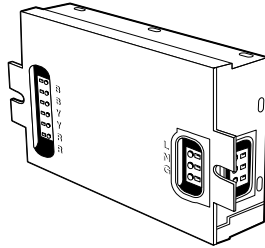



Electronic Multi-Exit with Studs (MES)



Electronic Multi-Exit (ME)



Lamp Matrix

	ANSI Lamp Designation	NEMA Lamp Designation	Built-In Starter	LAMP MANUFACTURER		
				GE	OSI	Philips
	5W/4T4/T/G23/PH	CFT5W/G23	YES	F5 BX	CF 5DS	PL-S 5W
	7W/5T4/T/G23/PH	CFT7W/G23	YES	F7 BX	CF 7DS	PL-S 7W
	9W/6T4/T/G23/PH	CFT9W/G23	YES	F9 BX	CF 9DS	PL-S 9W
	13W/7T4/T/GX23/PH	CFT13W/GX23	YES	F13 BX	CF 13DS	PL-S 13W
Twin, 2-Pin						
	9W/4T4/Q/G23-2/PH	CFQ9W/G23	YES	F9 DBX23	CF 9DD	—
	13W/5T4/Q/GX23-2/PH	CFQ13W/GX23	YES	F13 DBX23	CF 13DD	PL-C 13W/USA
Quad, 2-Pin						
	13W/6T4/Q/G24d-1/PH	CFQ13W/G24d	YES	F13 DBX T4	—	PL-C 13W
	18W/7T4/Q/G24d-2/PH	CFQ18W/G24d	YES	F18 DBX T4	CF 18DD	PL-C 18W
	26W/8T4/Q/G24d-3/PH	CFQ26W/G24d	YES	F26 DBX T4	CF 26DD	PL-C 26W
Quad, 2-Pin						
	13W/6T4/Q/G24q-1	CFQ13W/G24q	NO	F13 DBX/4P	CF 13DD/E	PL-C 13W/4P
	18W/7T4/Q/G24q-2	CFQ18W/G24q	NO	F18 DBX/4P	CF 18DD/E	PL-C 18W/4P
	26W/8T4/Q/G24q-3	CFQ26W/G24q	NO	F26 DBX/4P	CF 26DD/E	PL-C 26W/4P
Quad, 4-Pin						
	10W/3.5T4/S/GR10q-4	CFS10W/GR10q	NO	F10 2D/4P	—	—
	16W/5.5T4/S/GR10q-4	CFS16W/GR10q	NO	F16 2D/4P	—	—
	21W/5.5T4/S/GR10q-4	CFS21W/GR10q	NO	F21 2D/4P	—	—
	28W/8T6/S/GR8-2/PH	CFS28W/GR8	YES	F28 2D	—	—
	28W/8T6/S/GR10q-4	CFS28W/GR10q	NO	F28 2D/4P	—	—
	38W/8T6/S/GR10q-4	CFS38W/GR10q	NO	F38 2D/4P	—	—
	55W/8T6/S/GRY10q-3	CFS55W/GRY10q	NO	F55 2D/4P	—	—
Square, (2D)						
	20W/6T5/Q/GX32d-2/PH	CFQ20W/GX32d	YES	—	—	PL-C 15MM/22W
	27W/7T5/Q/GX32d-3/PH	CFQ27W/GX32d	YES	—	—	PL-C 15MM/28W
T5 Quad, 2-Pin						
	13W/6T4/T/2GX7	CFT13W/2GX7	NO	—	CF 13DS/E	—
Twin T4, 4-Pin						
	18-20W/9T5/T/2G11/PH-RS	FT18W/2G11	NO	F18 BX	FT 18DL	—
	18W/10T5/T/2G11/RS	FT18W/2G11/RS	NO	F18 BX/RS	FT 18DL/RS	PL-L 18W
	18W/5T5/T/2G10	CFM18W/2G10	NO	—	CF 18DF	—
	24-27W/13T5/T/2G11/PH-RS	FT24W/2G11/RS	NO	F27 BX/RS	FT 24DL	PL-L 24W
	24W/7T5/T/2G10	CFM24W/2G10	NO	—	CF 24DF	—
	36-39W/16T5/T/2G11/PH-RS	FT36W/2G11/RS	NO	F39 BX/RS	FT 36DL	PL-L 36W
	36W/9T5/T/2G10	CFM36W/2G10	NO	—	CF 36DF	—
	40W/22T5/T/2G11/RS	FT40W/2G11/RS	NO	F40 BX/RS	FT 40DL/RS	PL-L 40W/RS
	50W/22T5/T/2G11/RS	FT50W/2G11/RS	NO	F50 BX/RS	—	PL-L 50W/RS
	55W/21T5/T/2G11	FT55W/2G11	NO	F55 BX	FT 55DL	—
	80W/22T5/T/2G11	FT80W/2G11	NO	—	—	PL-L 80W
Long Twin T5, 4-Pin						
	18W/5T4/M/GX24d-2	CFM18W/GX24d	YES	—	CF 18DT	—
	26W/6T4/M/GX24d-3	CFM26W/GX24d	YES	—	CF 26DT	—
Multiple, 2-Pin						
	13W/5T4/M/GX24q-1	CFM13W/GX24q	NO	F13 TBX/4P	CF 13DT/E	—
	18W/5T4/M/GX24q-2	CFM18W/GX24q	NO	F18 TBX/4P	CF 18DT/E/IN	PL-T 18W/4P
	26W/6T4/M/GX24q-3	CFM26W/GX24q	NO	F26 TBX/4P	CF 26DT/E/IN	PL-T 26W/4P
	32W/6T4/M/GX24q-3	CFM32W/GX24q	NO	F32 TBX/4P/EOL	CF 32DT/E/IN	PL-T 32W/4P
	42W/7T4/M/GX24q-4	CFM42W/GX24q	NO	F42 TBX/4P/EOL	CF 42DT/E/IN	PL-T 42W/4P
	57W/7T4/M/GX24q-5	CFM57W/GX24q	NO	F57 QBX/4P/EOL	CF 57DT/E/IN	—
	70W/8T4/M/GX24q-6	CFM70W/GX24q	NO	F70 QBX/4P/EOL	—	—
Multiple, 4-Pin						
	—	FC9T5-22W/2GX13	NO	—	FPC22	FC9T5 22W
	—	FC12T5-40W/2GX13	NO	—	FPC40	FC12T5 40W
	—	FC12T5-55W/2GX13	NO	—	FPC55/HO	FC12T5 55W
T5 Circular, 4-Pin						

Compact Fluorescent

Specifications

TYPICAL SPECIFICATIONS FOR ELECTRONIC COMPACT FLUORESCENT BALLASTS:

- Ballasts shall be constructed of metal housing to meet plenum and construction code requirements while providing maximum heat transfer without extra grounding wires for extended ballast life.
- Ballasts shall be constructed using dual entry color coded wire trap terminals for wiring accuracy and ease of installation.
- Ballasts shall be Programmed Start.
- Ballasts shall have a minimum Rh/Rc of 4.25 each time the lamps are started.
- Ballasts shall have a maximum ionization current (Glow Current) of 25 milliamps during preheating interval.
- Ballasts shall operate from 50/60 Hz input source of 120 through 277 Volts, and sustained variations of $\pm 10\%$ (Voltage & Frequency) with no damage to the ballasts.
- Ballasts shall be a high frequency electronic type, and operate lamps at a frequency above 50 kHz to minimize interference with infrared control systems.
- Ballasts shall have a minimum starting temperature of 0°F (-18°C) for the primary lamp application.
- Ballasts shall tolerate operation in ambient temperatures up to 140°F (55°C) without damage.
- Ballasts shall have a maximum case temperature test point of 75°C printed on the label for easy fixture testing and trouble shooting.
- Ballasts shall support 12' lead length remote mounting for the primary lamp.
- Ballasts shall comply with FCC Part 18 Non-Consumer Equipment for EMI (power line conducted) and RFI (radiated).
- Ballasts shall provide transient immunity as recommended by ANSI C82.11-2011.
- Ballasts shall incorporate end of lamp life shutdown circuitry for end of lamp life protection.
- Ballasts shall allow for re-lamping without the need to cycle power.
- Ballasts shall operate lamps with no visible flicker (<3% flicker index).
- Ballasts shall tolerate sustained open and short circuit output conditions without damage.
- Ballasts shall be Underwriters Laboratory (UL 935) listed, Class P, Type 1 Outdoor and/or CSA certified for both US and Canadian application.
- Ballasts shall be UL 935 Type CC rated to reduce arcing caused by loose connections or improper lamp-pin to lampholder contact.
- Ballasts shall be UL 2043 certified for use in plenums and marked on label as "Suitable for Air Handling Spaces".
- Ballasts shall be quiet Class A sound rating.
- Ballasts shall have a Ballast Factor for primary lamp application greater than .95 per ANSI C82.11-2011.
- Input current Total Harmonic Distortion shall not exceed 10% for the primary lamp.
- Ballasts shall have a Power Factor greater than .98 for the primary lamp application.
- Lamp Current Crest Factor (ratio of peak to RMS current) shall be 1.7 or less in accordance with lamp manufacturer recommendation and ANSI C82.11-2011.
- The ballasts shall not have any PCB's.
- The manufacturer shall provide written warranty against defects in material or workmanship, including replacement, for five years from date of manufacture.
- Manufacturer shall have been manufacturing electronic ballasts for at least thirty years.
- Ballasts shall be manufactured in an ISO 9001 / ISO 9002 Certified Facility in North America.
- Ballasts shall be manufactured by Universal Lighting Technologies.

Understanding Universal Part Numbers

ELECTRONIC

Our nomenclature for electronic CFL ballasts follows the system already in place for other Universal electronic ballasts. The exceptions are that the model number prefix for compact fluorescent is a C rather than a B.

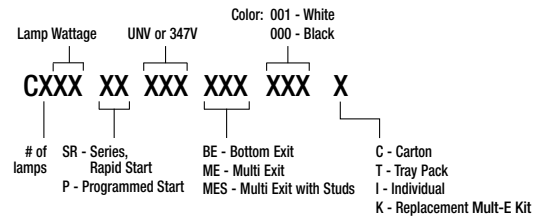

Example: Electronic C240PUNVHP-B000C

Ballast Type: C — CFL Electronic Ballast

Lamp Qty: 2

Lamp Type: 40W TT5, 4 Pin (FT40W/2611)

P: Programmed Start

Voltage: UNV 120 to 277 volts

HP-B: High Performance <10%; low profile can

000: Color — Black

C: Packaging container style — Carton Pack

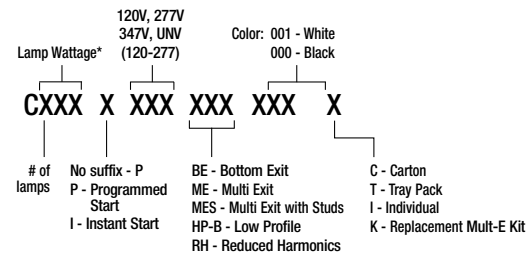

Example: C213UNVMES000C*

Ballast Type: C

Lamp Quantity: 2

Lamp Type: 13W Quad, 4 Pin (CFQ13W/G24q)

Voltage: UNV 120 to 277 volts

MES: Multi-exit connection, with studs

000C: Color — Black

C: Packaging container style — Carton Pack

*Exception is C2642, which does not distinguish number of lamps. See catalog.

Notes

MAGNETIC AND ELECTRONIC COMPACT FLUORESCENT BALLASTS FOR TWIN, QUAD AND MULTIPLE LAMPS

13-26 WATTS

- Ideal for downlights & wall sconces
- Electronic models feature universal input voltage from 120V to 277V. 347V models are also available.
- Electronic models feature programmed start for excellent lamp performance & auto reset shutdown circuit

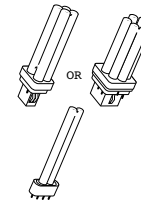

**TWIN, QUAD
& MULTIPLE
LAMPS**
13-26 WATTS

**QUICK
REFERENCE**
Nominal lamp watts
and configuration

Lamp Type	Mag or Elec	Qty of Lamps	Line Volt	Catalog Number	Input Watts	Line Current Amps	Starting Current Amps	Ballast Factor	Min Start Temp (F/C)	Power Factor	THD	Lead Configuration			Starting Method*	Dim	Wir Diag
												Side Exit	Multi Exit	Multi Exit Studs			
Electrical Characteristics - 60 Hz																	
13 Watts CFT13W/GX23 OR CFQ13W/GX23		1	120	CF1320H2P [■]	16	0.24	0.30	0.85	25°/-4°	>.50	<15%	X	—	—	PH	B10	1
13 Watts CFQ13W/G24q OR CFM13W/GX24q		1	120	C213UNVME [×]	18	0.15	—	1.00	0°/-18°	>.98	<10%		X	X	PS	C3	3
		2	277	C213UNVME [×]	30	0.07	—	1.00	0°/-18°	>.98	<10%		X	X	PS	C3	4
		1	347	C213/347ME [*]	18	0.26	—	1.00	0°/-18°	>.98	<10%		X	X	PS	C3	3
		2	277	C213/347ME [*]	33	0.11	—	0.98	0°/-18°	>.98	<10%		X	X	PS	C3	4
13 Watts CFT13W/2GX7		1	120	CT213UNVME	15	0.12	—	0.98	0°/-18°	>.98	<10%		X	X	PS	C3	3
		2	277	CT213UNVME	26	0.06	—	0.98	0°/-18°	>.98	<12%		X	X	PS	C3	4
18 Watts CFQ18W/G24q OR CFM18W/GX24q		1	120	C218UNV ^{♦×}	19	0.16	—	1.00	0°/-18°	>.98	<10%		X	X	PS	C3	3
		2	277	C218UNV ^{♦×}	35	0.07	—	0.95	0°/-18°	>.98	<15%		X	X	PS	C3	4
		1	120	C218UNV ^{♦×}	30	0.30	—	1.00	0°/-18°	>.98	<10%		X	X	PS	C3	4
		2	277	C218UNV ^{♦×}	35	0.13	—	0.95	0°/-18°	>.98	<10%		X	X	PS	C3	4
		1	347	C218/347ME [*]	21	0.06	—	1.00	0°/-18°	>.98	<10%		X	X	PS	C3	3
		2	277	C218/347ME [*]	38	0.11	—	0.98	0°/-18°	>.98	<10%		X	X	PS	C3	4
26 Watts CFQ26W/G24q OR CFM26W/GX24q		1	120	C2642UNV ^{♦×}	28	0.25	—	1.02	0°/-18°	>.98	<10%		X	X	PS	C3	3
		2	277	C2642UNV ^{♦×}	56	0.11	—	0.98	0°/-18°	>.98	<10%		X	X	PS	C3	4
		1	347	C2642/347ME [*]	31	0.47	—	1.02	0°/-18°	>.98	<10%		X	X	PS	C3	3
		2	277	C2642/347ME [*]	57	0.21	—	0.98	0°/-18°	>.98	<10%		X	X	PS	C3	4
		2	120	C242UNV [♦]	56	0.46	—	1.02	0°/-18°	>.95	<10%		X	X	PS	C4	4
		2	277	C242UNV [♦]	55	0.20	—	1.02	0°/-18°	>.95	<10%		X	X	PS	C4	4
		2	347	C242/347ME	44	0.14	—	1.02	0°/-18°	>.98	<10%		X	X	PS	C4	4

♦ PH = Preheat; PS = Programmed Start

- H2 indicates clamped & covered core & coil with mounting feet.
- ♦ Add following suffix for complete catalog #: "BE" for Bottom Exit connectors, "ME" for Multi Exit connectors, or "MES" for Multi Exit with 2" OC screw studs.
- Not approved for use in hazardous locations.
- × Add "000K" suffix for Multi-E Kit. For Distribution only.
- * Add "001K" suffix for Multi-E Kit. For Distribution only.

All ballasts are UL listed, CSA approved and designated Class P (thermally protected).

**See page 3-11 for Dimensions
and Wiring Diagrams.**

Compact Fluorescent

MULTIPLE LAMPS



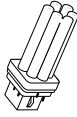

32, 42, 57 & 70 WATTS



- Ideal for downlights, surface mount & outdoor fixtures
- Electronic models feature universal input voltage from 120V to 277V. 347V models are also available.
- Electronic models feature programmed start for excellent lamp performance & auto reset shutdown circuit

ELECTRONIC COMPACT FLUORESCENT BALLASTS FOR MULTIPLE LAMPS

32, 42, 57 & 70 WATTS

QUICK REFERENCE Nominal lamp watts and configuration	Mag or Elec	Qty of Lamps	Line Volt	Catalog [Ⓢ] Number	Input Watts	Line Current Amps	Starting Current Amps	Ballast Factor	Min Start Temp (F/C)	Power Factor	THD	Lead Configuration			Starting Method [Ⓢ]	Dim	Wir Diag
												Side Exit	Multi Exit	Multi Exit Studs			
Lamp Type																	
32 Watts																	
CFM32W/GX24q 	E	1	120	C2642UNV [Ⓢ] x	36	0.30	—	1.00	0°/-18°	>.98	<10%	X	X	PS	C3	3	
	E	1	347		C2642/347ME*	36	0.11	—	0.98	0°/-18°	>.98	<10%	X	X	PS	C3	3
	E	2	120	C242UNV [Ⓢ]	69	0.58	—	1.00	0°/-18°	>.98	<10%	X	X	PS	C4	4	
	E	2	347		C242/347ME	62	0.19	—	1.00	0°/-18°	>.98	<10%	X	X	PS	C4	4
Multiple, 4-Pin																	
Lamp Type																	
42 Watts																	
CFM42W/GX24q 	E	1	120	C2642UNV [Ⓢ] x	48	0.41	—	0.98	0°/-18°	>.98	<10%	X	X	PS	C3	3	
	E	1	347		C2642/347ME*	50	0.15	—	1.00	0°/-18°	>.98	<10%	X	X	PS	C3	3
	E	1	120	C242UNV [Ⓢ]	45	0.40	—	1.00	0°/-18°	>.93	<10%	X	X	PS	C4	3	
	E	2	120		C242UNV [Ⓢ]	91	0.76	—	0.98	0°/-18°	>.98	<10%	X	X	PS	C4	4
	E	1	347	C242/347ME	42	0.13	—	1.00	0°/-18°	>.98	<10%	X	X	PS	C4	3	
Multiple, 4-Pin																	
Lamp Type																	
57 Watts																	
CFM57W/GX24q 	E	1	120	C242UNV [Ⓢ]	58	0.52	—	1.00	0°/-18°	>.98	<10%	X	X	PS	C4	3	
	E	1	347		C242/347ME	61	0.18	—	1.00	0°/-18°	>.98	<10%	X	X	PS	C4	3
Multiple, 4-Pin																	
Lamp Type																	
70 Watts																	
CFM70W/GX24q 	E	1	120	C242UNV [Ⓢ]	73	0.61	—	1.00	0°/-18°	>.98	<10%	X	X	PS	C4	3	
	E	1	347		C242/347ME	74	0.21	—	1.00	0°/-18°	>.98	<10%	X	X	PS	C4	3
Multiple, 4-Pin																	

Ⓢ PS = Programmed Start

◆ Add following suffix for complete catalog #: "BE" suffix for Bottom Exit connectors, "ME" for multi-exit connectors, or "MES" for multi exit connectors with 2" O.C. screw studs.

✕ Add "000K" suffix for Mult-E Kit. For Distribution only.

* Add "001K" suffix for Mult-E Kit. For Distribution only.

All ballasts are UL listed, CSA approved and designated Class P (thermally protected), Type HL.

See page 3-11 for Dimensions and Wiring Diagrams.

MAGNETIC AND ELECTRONIC COMPACT FLUORESCENT BALLASTS

WIRING DIAGRAMS AND DIMENSIONS

REFERENCE DRAWING FOR B10

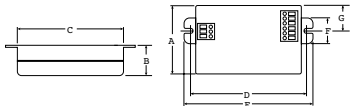

Dwg.	A	B	D	E
B10	1.48"	1.30"	2.68"	3.08"

Leadless-Poke-in wire connection

REFERENCE DRAWING FOR C3

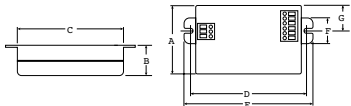

Dwg.	A	B	C	D	E	F	G
C3	2.31"	1.00"	4.25"	4.61"	4.94"	0.98"	1.00"

Leadless-Poke-in wire connection

REFERENCE DRAWING FOR C4

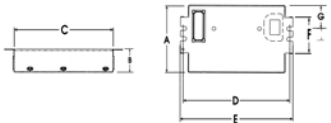

Dwg.	A	B	C	D	E	F	G
C4	2.98"	1.00"	4.25"	4.61"	4.94"	1.55"	1.00"

Leadless-Poke-in wire connection

Note: Nominal dimensions provided above
Contact Universal for drawings and/or tolerances

WIRING DIAGRAMS

Install in accordance with
National Electrical Code.

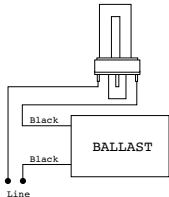

DIAGRAM 1

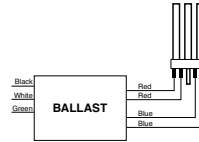

DIAGRAM 3

Ballast should be grounded

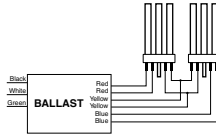

DIAGRAM 4



Series lamp operation
Ballast should be grounded

2D LAMPS 10, 16 & 21 WATTS



- Ideal for surface mount fixtures
- Universal input voltage from 120V to 277V. 347V models are also available.
- Programmed start for excellent lamp performance & auto reset shutdown circuit

ELECTRONIC COMPACT FLUORESCENT BALLASTS FOR 2D LAMPS 10, 16 AND 21 WATTS

QUICK REFERENCE Nominal lamp watts and configuration	Mag or Elec	Qty of Lamps	Line Volt	Catalog [Ⓞ] Number	Input Watts	Line Current Amps	Starting Current Amps	Ballast Factor	Min Start Temp (F/C)	Power Factor	THD	Lead Configuration			Starting Method [⚡]	Dim	Wir Diag
												Side Exit	Multi Exit	Multi Exit Studs			
Lamp Type																	
10 Watts																	
CFS10W/GR10q 	E	1	120 277	C213UNVME ^x	15	0.12 0.06	---	1.02	0°/-18°	>.98 >.95	<10% <15%	---	X	X	PS	C3	2a
	E	2	120 277	C213UNVME ^x	26	0.22 0.10	---	1.02	0°/-18°	>.98 >.95	<10% <15%	---	X	X	PS	C3	3a
	E	1	347	C213/347ME [*]	16	0.05	---	1.02	0°/-18°	>.98 >.95	<10% <15%	---	X	X	PS	C3	2a
	E	2	347	C213/347ME [*]	28	0.08	---	1.02	0°/-18°	>.98 >.95	<10% <15%	---	X	X	PS	C3	3a
2D, 4-Pin																	
Lamp Type																	
16 Watts																	
CFS16W/GR10q 	E	1	120 277	C213UNVME ^x	19	0.15 0.07	---	0.95	0°/-18°	>.98 >.95	<10% <15%	---	X	X	PS	C3	2a
	E	1	347	C213/347ME [*]	20	0.06	---	0.95	0°/-18°	>.98 >.95	<10% <15%	---	X	X	PS	C3	2a
	E	2	120 277	C213UNVME ^x	33	0.28 0.12	---	0.95	0°/-18°	>.98 >.95	<10% <15%	---	X	X	PS	C3	3a
	E	2	347	C213/347ME [*]	34	0.10	---	0.95	0°/-18°	>.98 >.95	<10% <15%	---	X	X	PS	C3	3a
2D, 4-Pin																	
Lamp Type																	
21 Watts																	
CFS21W/GR10q 	E	1	120 277	C218UNV ^{**}	24	0.18 0.08	---	0.98	0°/-18°	>.98 >.95	<10% <15%	---	X	X	PS	C3	2a
	E	1	347	C218/347ME [*]	21	0.06	---	0.98	0°/-18°	>.98 >.95	<10% <15%	---	X	X	PS	C3	2a
	E	2	120 277	C218UNV ^{**}	43	0.37 0.16	---	0.95	0°/-18°	>.98 >.95	<10% <15%	---	X	X	PS	C3	3a
	E	2	347	C218/347ME [*]	39	0.12	---	0.95	0°/-18°	>.98 >.95	<10% <15%	---	X	X	PS	C3	3a
2D, 4-Pin																	

⚡ PS = Programmed Start

◆ Add following suffix for complete catalog #: "BE" for Bottom Exit connectors, "ME" for Multi Exit connectors, or "MES" for MultiExit with 2" OC screw studs.

✕ Add "000K" suffix for Multi-E Kit. For Distribution only.

* Add "001K" suffix for Multi-E Kit. For Distribution only.

All ballasts are UL listed, CSA approved and designated Class P (thermally protected), Type HL.



See page 3-14 for Dimensions
and Wiring Diagrams.

ELECTRONIC COMPACT FLUORESCENT BALLASTS FOR 2D LAMPS

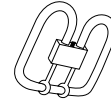
- Ideal for surface mount fixtures
- Universal input voltage from 120V to 277V.
- Programmed start for excellent lamp performance & auto reset shutdown circuit



**2D
LAMPS
28 & 38
WATTS**

QUICK REFERENCE Nominal lamp watts and configuration	Mag or Elec	Qty of Lamps	Line Volt	Catalog [⊕] Number	Input Watts	Line Current Amps	Starting Current Amps	Ballast Factor	Min Start Temp (F/C)	Power Factor	THD	Lead Configuration			Starting Method [⊕]	Dim	Wir Diag
												Side Exit	Multi Exit	Multi Exit Studs			
Lamp Type	Electrical Characteristics - 60 Hz																
28 Watts CFS28W/GR10q		1	120	C2642UNV**	31	0.27	---	0.95	0°/-18°	>.95	<10%	---	X	X	PS	C3	2a
277			C2642/347ME*	33	0.10	---	0.95	0°/-18°	>.95	<10%	---	X	X	PS	C3	2a	
E		2	120	C242UNV*	64	0.54	---	1.00	0°/-18°	>.97	<10%	---	X	X	PS	C4	3a
			277		63	0.24											
E	2	347	C242/347ME	60	0.18	---	1.00	0°/-18°	>.98	<10%	---	X	X	PS	C4	3a	
Lamp Type	Electrical Characteristics - 60 Hz																
38 Watts CFS38W/GR10q		1	120	C2642UNV [⊕] ×	33	0.27	---	0.80	0°/-18°	>.95	<10%	---	X	X	PS	C3	2a
277																	

- ⊕ PS = Programmed Start
- ◆ Add following suffix for complete catalog #: "BE" for Bottom Exit connectors, "ME" for Multi Exit connectors, or "MES" for Multi Exit with 2" OC screw studs.
- × Add "000K" suffix for Mult-E Kit. For Distribution only.
- * Add "001K" suffix for Mult-E Kit. For Distribution only.

All ballasts are UL listed, CSA approved and designated Class P (thermally protected), Type HL.

See page 3-14 for Dimensions and Wiring Diagrams.

ELECTRONIC COMPACT FLUORESCENT BALLASTS FOR 2D LAMPS WIRING DIAGRAMS AND DIMENSIONS

REFERENCE DRAWING FOR C3

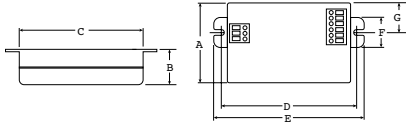

Dwg.	A	B	C	D	E	F	G
C3	2.31"	1.00"	4.25"	4.61"	4.94"	0.98"	1.00"

Leadless-Poke-in wire connection

REFERENCE DRAWING FOR C4

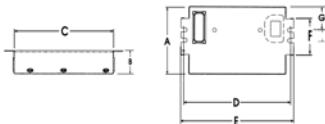

Dwg.	A	B	C	D	E	F	G
C4	2.98"	1.00"	4.25"	4.61"	4.94"	1.55"	1.00"

Leadless-Poke-in wire connection

WIRING DIAGRAMS

Install in accordance with
National Electrical Code.

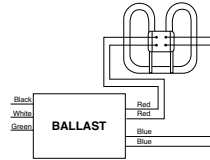

DIAGRAM 2a

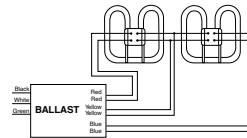

DIAGRAM 3a
Series lamp operation

Note: Nominal dimensions provided above
Contact Universal for drawings and/or tolerances



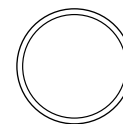

ELECTRONIC COMPACT FLUORESCENT BALLASTS

22, 40 & 55 WATTS

- Ideal for surface mount fixtures
- Electronic models feature universal input voltage from 120V to 277V. 347V models are also available.
- Electronic models feature programmed start for excellent lamp performance & auto reset shutdown circuit



**T5
CIRCULAR
LAMPS**
22, 40 & 55 WATTS

QUICK REFERENCE Nominal lamp watts and configuration	Mag or Elec	Qty of Lamps	Line Volt	Catalog [®] Number	Input Watts	Line Current Amps	Starting Current Amps	Ballast Factor	Min Start Temp (F/C)	Power Factor	THD	Lead Configuration			Starting Method [★]	Dim	Wir Diag	
												Side Exit	Multi Exit	Multi Exit Studs				
Lamp Type Electrical Characteristics - 60 Hz																		
22 Watts FC9T5-22W 	E	1	347	C2642/347ME*	26	0.08	—	0.98	0°/-18°	>.98	<10%	—	X	X	PS	C3	2b	
	E	1	120	C2642UNV♦×	25	0.21	—	1.00	0°/-18°	>.98	<10%	—	X	X	PS	C3	2b	
	E	2	347	C242/347ME	47	0.14	—	1.05	0°/-18°	>.98	<10%	—	X	X	PS	C4	1b	
	E	2	120	C242UNV♦	50	0.42	—	1.05	0°/-18°	>.95	<10%	—	X	X	PS	C4	1b	
40 Watts FC12T5-40W 	E	1	347	C2642/347ME*	40	0.12	—	0.98	0°/-18°	>.98	<10%	—	X	X	PS	C3	2b	
	○	E	1	120	C2642UNV♦×	42	0.35	—	0.98	0°/-18°	>.98	<10%	—	X	X	PS	C3	2b
	○	E	2	347	C242/347ME	71	0.22	—	0.98	0°/-18°	>.98	<10%	—	X	X	PS	C4	1b
	○	E	2	120	C242UNV♦	80	0.65	—	0.98	0°/-18°	>.98	<10%	—	X	X	PS	C4	1b
22 & 40 Watts FC9T5-22W & FC12T5-40W 	E	1+1	120	C242/347ME	59	0.18	—	0.98	0°/-18°	>.98	<10%	—	X	X	PS	C4	1b	
	E	1+1	277	C242UNV♦	66	0.54	—	0.98	0°/-18°	>.97	<10%	—	X	X	PS	C4	1b	
55 Watts FC12T5-55W 	E	1	120	B2 54PUNV-D	55	0.45	—	1.00	-20/-29	>.99	<10%	X	—	—	PS	-D	2b	
	E	1	277	B254PUNVHB-D	55	0.20	—	1.00	-20/-29	>.96	<10%	X	—	—	PS	-D	2b	
	E	1	120	B254PUNVPL-A	51	0.43	—	1.00	-20/-29	>.99	<10%	X	—	—	PS	-A	1b	
	E	1	277	B254PUNVPLHBA	50	0.20	—	1.00	-20/-29	>.91	<10%	X	—	—	PS	-A	1b	
	E	1	120	B254PUNVPLHBA	50	0.43	—	1.00	-20/-29	>.99	<10%	X	—	—	PS	-A	1b	
	E	1	277	B254PUNVPLHBA	50	0.20	—	1.00	-20/-29	>.91	<10%	X	—	—	PS	-A	1b	
	E	2	120	B254PUNV-D	107	0.88	—	1.00	-20/-29	>.99	<10%	X	—	—	PS	-D	1b	
	E	2	277	B254PUNV-D	104	0.38	—	1.00	-20/-29	>.98	<10%	X	—	—	PS	-D	1b	
	E	2	120	B254PUNVHB-D	107	0.88	—	1.00	-20/-29	>.99	<10%	X	—	—	PS	-D	1b	
	E	2	277	B254PUNVHB-D	104	0.38	—	1.00	-20/-29	>.98	<10%	X	—	—	PS	-D	1b	
E	2	120	B254PUNVPL-A	92	0.77	—	0.96	-20/-29	>.99	<10%	X	—	—	PS	-A	1b		
E	2	277	B254PUNVPL-A	91	0.34	—	0.96	-20/-29	>.97	<10%	X	—	—	PS	-A	1b		
E	2	120	B254PUNVPLHBA	92	0.77	—	0.96	-20/-29	>.99	<10%	X	—	—	PS	-A	1b		
E	2	277	B254PUNVPLHBA	91	0.34	—	0.96	-20/-29	>.97	<10%	X	—	—	PS	-A	1b		

Compact Fluorescent



LONG TWIN T5 LAMPS 18, 24/27 WATTS



- Ideal for track light & surface mount fixtures
- Electronic models feature universal input voltage from 120V to 277V. 347V models are also available
- Electronic models feature rapid and programmed start for excellent lamp performance & auto reset shutdown circuit

ELECTRONIC COMPACT FLUORESCENT BALLASTS FOR LONG TWIN T5 LAMPS

18 AND 24/27 WATTS (BIAX, DULUX L AND PLL)

QUICK REFERENCE Nominal lamp watts and configuration	Mag or Elec	Qty of Lamps	Line Volt	Catalog [Ⓞ] Number	Input Watts	Line Current Amps	Starting Current Amps	Ballast Factor	Min Start Temp (F/C)	Power Factor	THD	Lead Configuration			Starting Method [✱]	Dim	Wir Diag
												Side Exit	Multi Exit	Multi Exit Studs			
Lamp Type																	
Electrical Characteristics - 60 Hz																	
18 Watts																	
FT18W/2G11/RS 	E	1	120	CT218UNVME	23	0.19	---	1.00	0°/-18°	>.95	<10%	-	X	X	PS	C3	21
			277			0.07							---	---			
	E	2	120	CT218UNVME	43	0.37	---	0.98	0°/-18°	>.98	<10%	-	X	X	PS	C3	20
			277		42	0.16							---	---			
24/27 Watts																	
FT24W/2G11/RS 	○ E	1	120	B224PUNV-C	27	0.23	---	1.05	0°/-18°	>.98	<10%	X	-	-	PS	-C	43
			277			0.10											
	○ E	1	120	C2642/347ME*	29	0.09	---	0.90	0°/-18°	>.95	<10%	-	X	X	PS	C3	21
			277			0.22							>.99	<10%			
	○ E	1	120	C2642UNV×	26	0.10	---	1.01	0°/-18°	>.95	<10%	-	X	X	PS	C3	21
			277			0.10							>.95	<10%			
	○ E	2	120	B224PUNV-C	52	0.43	---	1.00	0°/-18°	>.98	<10%	X	-	-	PS	-C	27
			277			51											
	○ E	2	347	C242/347ME	49	0.14	---	1.02	0°/-18°	>.98	<10%	-	X	X	PS	C4	20
			120			51							0.43	>.95			
○ E	2	120	C242UNV◆	50	0.19	---	1.02	0°/-18°	>.95	<10%	-	X	X	PS	C4	20	
		277			50							0.19	>.95				<10%
○ E	2	120	C2642UNV×	47	0.40	---	0.98	0°/-18°	>.98	<10%	-	X	X	PS	C3	20	
		277			49							0.18	>.99				<10%
24/27 Watts																	
CFM24W/2G10 	○ E	1	120	B224PUNV-C	24	0.20	---	1.05	0°/-18°	>.98	<10%	X	-	-	PS	-C	43
			277			0.09											
○ E	2	120	B224PUNV-C	48	0.40	---	1.00	0°/-18°	>.98	<10%	X	-	-	PS	-C	29	
		277			47												0.17

- ✱ PS = Programmed Start
- Not approved for use in hazardous locations
- ◆ Add following suffix for complete catalog #: "BE" for Bottom Exit connectors, "ME" for Multi Exit connectors, or "MES" for Multi Exit with 2" OC screw studs.
- × Add "000K" suffix for Multi-E Kit. For Distribution only.
- * Add "001K" suffix for Multi-E Kit. For Distribution only.

All ballasts are UL listed, CSA approved and designated Class P (thermally protected).

Compact Fluorescent

See pages 3-19 and 3-20 for
Dimensions and Wiring Diagrams.



ELECTRONIC LONG TWIN T5 BALLASTS

36/39 AND 40 WATTS (BIAx, DULUX L AND PLL)

- Ideal for track light & surface mount fixtures
- New electronic 1 & 2 lamp models for 24 watt lamps
- Electronic models feature universal input voltage from 120V to 277V. 347V models are also available.
- Electronic models feature programmed rapid start for excellent lamp performance & auto reset shutdown circuit



**LONG TWIN
T5 LAMPS**
36/39 & 40
WATTS

QUICK REFERENCE Nominal lamp watts and configuration	Mag or Elec	Qty of Lamps	Line Volt	Catalog [®] Number	Input Watts	Line Current Amps	Starting Current Amps	Ballast Factor	Min Start Temp (F/C)	Power Factor	THD	Lead Configuration			Starting Method [⚡]	Dim	Wir Diag	
												Side Exit	Multi Exit	Multi Exit Studs				
Lamp Type																		
Electrical Characteristics - 60 Hz																		
36/39 Watts FT36W/2G11/RS  Long Twin T5, 4-Pin	○ E	1	120 277	B224PUNV-C•	36	0.30 0.13	---	0.95	0/-18	>.98 >.95	<10%	X	--	--	PS	-C	43	
	○ E	1	120 277	B254PUNV-D•	44	0.37 0.17	---	1.20	-20/-29	>.99 >.94	<10%	X	--	--	PS	-D	43	
	E	1	120 277	B254PUNVHB-D	44	0.37 0.17	---	1.20	-20/-29	>.99 >.94	<10%	X	--	--	PS	-D	43	
	E	1	120 277	B254PUNVPL-A	46 45	0.38 0.18	---	1.00	-20/-29	>.99 >.90	<10%	X	--	--	PS	-A	A	
	E	1	120 277	B254PUNVPLHBA	46 45	0.38 0.18	---	1.00	-20/-29	>.99 >.90	<10%	X	--	--	PS	-A	A	
	○ E	1	120 277	C242UNV♦	34 33	0.29 0.14	---	0.88	0/-18	>.99 >.90	<10% <20%	X	X	X	PS	C4	21	
	○ E	2	120 277	B239PUNV-D•	71 70	0.59 0.26	---	0.97	0/-18	>.98 >.95	<10%	X	--	--	PS	-D	29	
	○ E	2	120 277	B254PUNV-D	89 83	0.70 0.30	---	1.10	-20/-29	>.99 >.97	<10%	X	--	--	PS	-D	29	
	E	2	120 277	B254PUNVHB-D	89 83	0.70 0.30	---	1.10	-20/-29	>.99 >.97	<10%	X	--	--	PS	-D	29	
	E	2	120 277	B254PUNVPL-A	85 83	0.71 0.31	---	0.98 0.96	-20/-29	>.99 >.96	<10%	X	--	--	PS	-A	A	
	E	2	120 277	B254PUNVPLHBA	85 83	0.71 0.31	---	0.98 0.96	-20/-29	>.99 >.96	<10%	X	--	--	PS	-A	A	
	E	2	347	C242/347♦♦	64	0.19	---	0.90	0/-18	>.98	<10%	--	X	X	PS	C4	20	
	E	2	120 277	C242UNV♦♦	64	0.57 0.25	---	0.83	0/-18	>.99 >.97	<10%	--	X	X	PS	C4	20	
	Lamp Type																	
	36/39 Watts																	
CFM36W/2G10  T5 F-Lamp, 4-Pin	E	1	120 277	B224PUNV-C•	34	0.28 0.12	---	0.95	0/-18	>.98 >.95	<10%	X	--	--	PS	-C	43	
	E	1	120 277	C2642UNV♦x	32	0.27 0.12	---	0.98	0/-18	>.98	<10%	--	X	X	PS	C3	21	
	E	1	120 277	C242UNV♦	33	0.28 0.14	---	0.98	0/-18	>.99 >.90	<15%	--	X	X	PS	C4	21	
	E	2	120 277	C242UNV♦♦x	68 67	0.57 0.25	---	0.90	0/-18	>.95	<10%	--	X	X	PS	C4	20	
Lamp Type																		
40 Watts																		
FT40W/2G11  Long Twin T5, 4-Pin	○ E	1	120	C240SI120RH	43	0.38	---	1.02	50/10	>.90	<20%	X	--	--	IS	C6	12+	
	○ E	1	277	C240SI277RH	43	0.17	---	1.02	50/10	>.90	<20%	X	--	--	IS	C6	12+	
	E	1	120 277	C240PUNVHP-B•	41 40	0.34 0.15	---	1.00	0/-18	>.95	<10%	X	--	--	PS	-B	21	
	E	1	120 277	C242UNV♦	47	0.40 0.18	---	1.08	0/-18	>.99 >.97	<10%	--	X	X	PS	C4	21	
	○ E	2	120 277	C240PUNVHP-B•	76 73	0.63 0.27	---	0.90	0/-18	>.98	<10%	X	--	--	PS	-B	20	
	○ E	2	120	C240SI120RH	70	0.59	---	0.88	50/10	>.95	<20%	X	--	--	IS	C6	12	
	○ E	2	277	C240SI277RH	70	0.25	---	0.88	50/10	>.95	<20%	X	--	--	IS	C6	12	
	E	2	120 277	C242UNV♦	93 87	0.78 0.34	---	1.00	0/-18	>.99 >.98	<10%	--	X	X	PS	C4	20	
	E	2	120	C340SI120RH	78	0.68	---	0.99	50/10	>.90	<20%	X	--	--	IS	C6	14+	
	E	2	277	C340SI277RH	77	0.28	---	0.99	50/10	>.90	<20%	X	--	--	IS	C6	14+	
	E	3	120	C340SI120RH	104	0.88	---	0.88	50/10	>.95	<20%	X	--	--	IS	C6	14	
E	3	277	C340SI277RH	102	0.37	---	0.88	50/10	>.95	<10%	X	--	--	IS	C6	14		
E	3	347	B332I347HP	97	0.28	---	0.85	0/-18	>.99	<20%	X	--	--	IS	ST	6		

Compact Fluorescent

MAGNETIC AND ELECTRONIC COMPACT FLUORESCENT BALLASTS DIMENSIONS

**LONG TWIN
T5 LAMPS**

QUICK REFERENCE Nominal lamp watts and configuration	Mag or Elec	Qty of Lamps	Line Volt	Catalog [®] Number	Input Watts	Line Current Amps	Starting Current Amps	Ballast Factor	Min Start Temp (F/C)	Power Factor	THD	Lead Configuration			Starting Method ¹	Wir Dim	Wir Diag
												Side Exit	Multi Exit	Multi Exit Studs			
Lamp Type	Electrical Characteristics - 60 Hz																
55 Watts	E	2	347	B254P347-D	102	0.30	---	0.90	-20/-29	>.98	<10%	X	---	---	PS	-D	27
FT55W/2G11 	E	2	347	B254PHRVHB-E	109	0.33	---	0.90	-20/-29	>.98	<10%	X	---	---	PS	-E	41
	E	2	480		108	0.24	---	0.90	-20/-29	>.95	<10%	X	---	---	PS	-E	41
Long Twin T5, 4-Pin	E	2	120	B254PUNV-D	112	0.93	---	1.00	-20/-29	>.99	<10%	X	---	---	PS	-D	29
	E	2	277		109	0.39	---	1.00	-20/-29	>.98	<10%	X	---	---	PS	-D	29
	E	2	120	B254PUNVHB-D	112	0.93	---	1.00	-20/-29	>.99	<10%	X	---	---	PS	-D	29
	E	2	277		109	0.39	---	1.00	-20/-29	>.98	<10%	X	---	---	PS	-D	29
	E	2	120	B254PUNVPL-A ¹	107	0.89	---	0.93	-20/-29	>.99	<10%	X	---	---	PS	-A	A
	E	2	277		104	0.38	---	0.93	-20/-29	>.97	<10%	X	---	---	PS	-A	A
	E	2	120	B254PUNVPLHBA ¹	107	0.89	---	0.93	-20/-29	>.99	<10%	X	---	---	PS	-A	A
	E	2	277		104	0.38	---	0.93	-20/-29	>.97	<10%	X	---	---	PS	-A	A
	E	3	120	B454PUNV-E	174	1.45	---	0.93	-20/-29	>.98	<10%	X	---	---	PS	-E	44
	E	3	277		171	0.62	---	0.93	-20/-29	>.95	<10%	X	---	---	PS	-E	44
	E	3	120	B454PUNVHB-E	174	1.45	---	0.93	-20/-29	>.98	<10%	X	---	---	PS	-E	44
	E	3	277		171	0.62	---	0.93	-20/-29	>.95	<10%	X	---	---	PS	-E	44
	E	3	120	B454PUNVPL-E ¹	148	1.25	---	0.93	-20/-29	>.99	<10%	X	---	---	PS	-E	B
	E	3	277		146	0.54	---	0.93	-20/-29	>.97	<10%	X	---	---	PS	-E	B
	E	3	120	B454PUNVPLHBE ¹	148	1.25	---	0.93	-20/-29	>.99	<10%	X	---	---	PS	-E	B
	E	3	277		146	0.54	---	0.93	-20/-29	>.97	<10%	X	---	---	PS	-E	B
	E	4	120	B454PUNV-E	229	1.91	---	0.90	-20/-29	>.98	<10%	X	---	---	PS	-E	44
	E	4	277		223	0.80	---	0.90	-20/-29	>.98	<10%	X	---	---	PS	-E	44
	E	4	120	B454PUNVHB-E	229	1.91	---	0.90	-20/-29	>.98	<10%	X	---	---	PS	-E	44
	E	4	277		223	0.80	---	0.90	-20/-29	>.98	<10%	X	---	---	PS	-E	44
	E	4	120	B454PUNVPL-E ¹	191	1.61	---	0.93	-20/-29	>.99	<10%	X	---	---	PS	-E	B
	E	4	277		187	0.69	---	0.93	-20/-29	>.98	<10%	X	---	---	PS	-E	B
	E	4	120	B454PUNVPLHBE ¹	191	1.61	---	0.93	-20/-29	>.99	<10%	X	---	---	PS	-E	B
	E	4	277		187	0.69	---	0.93	-20/-29	>.98	<10%	X	---	---	PS	-E	B

1 Consult factory for availability

REFERENCE DRAWING FOR -B

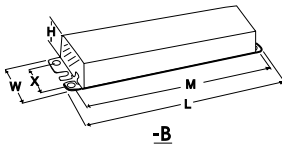

Dwg.	L	W	H	M	X
-B	9.50"	1.50"	1.00"	8.89"	0.88"

REFERENCE DRAWING FOR C4

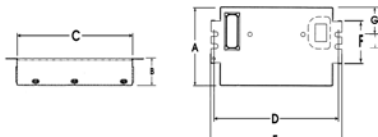

Dwg.	A	B	C	D	E	F	G
C4	2.98"	1.00"	4.25"	4.61"	4.94"	1.56"	1.00"

Leadless-Poke-in wire connection

REFERENCE DRAWING FOR C3

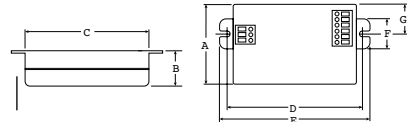

Dwg.	A	B	C	D	E	F	G
C3	2.31"	1.00"	4.25"	4.61"	4.94"	0.98"	1.00"

Leadless-Poke-in wire connection

REFERENCE DRAWING FOR C6

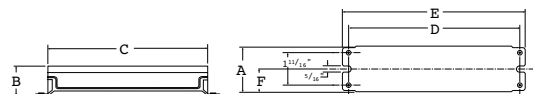

Dwg.	A	B	C	D	E	F
C6	2.40"	1.55"	8.31"	8.89"	9.50"	1.19"

Lead Lengths: Side

- Black/White-11"
- Red/Blue-16"
- Yellow-16"

Note: Nominal dimensions provided above
Contact Universal for drawings and/or tolerances

MAGNETIC AND ELECTRONIC COMPACT FLUORESCENT BALLASTS WIRING DIAGRAMS

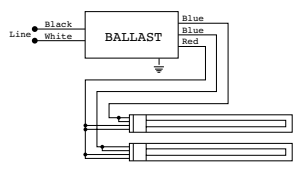

DIAGRAM 12
Parallel lamp operation

* Cap unused blue lead; insulate to 600 volts.

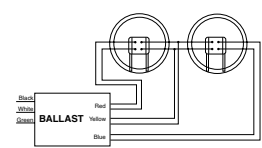

DIAGRAM 23
Series lamp operation

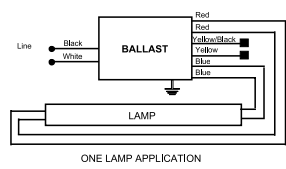

DIAGRAM 42
ONE LAMP APPLICATION
For one lamp application, individually cap yellow and yellow/black leads, insulate to 600V

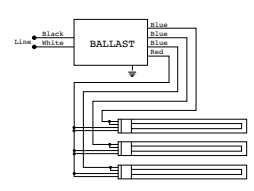

DIAGRAM 14
Parallel lamp operation

* Cap unused blue lead; insulate to 600 volts.

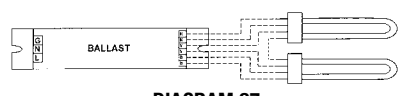

DIAGRAM 27
Series lamp operation

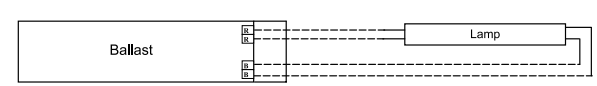

DIAGRAM 43

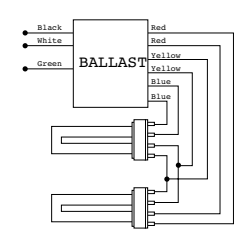

DIAGRAM 20
Series lamp operation

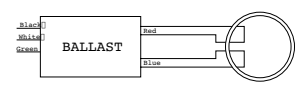
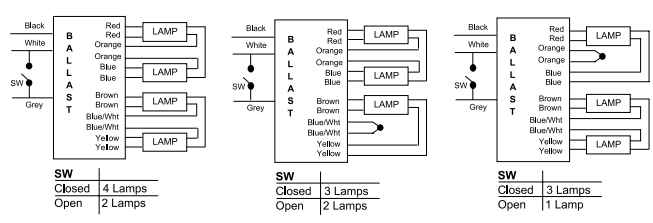

DIAGRAM 28



Application Notes:
 - 'SW' controls the lamps connected between the Brown and Yellow leads
 - For lamp switching applications, connect 'SW' between the white and the grey leads as shown in the wiring diagram above OR between the Black and Grey leads. The switch "SW" may be an on-off switch, an occupancy sensor, a relay, etc.
 - If lamp switching is not required, short the white and grey leads OR the black and the grey leads
 - A single control device, 'SW', may be connected to control multiple ballasts
 - For three lamp use: Short Blue/White leads or Orange leads and cap

DIAGRAM 44

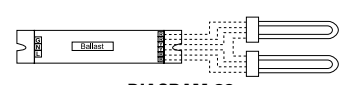

DIAGRAM 29

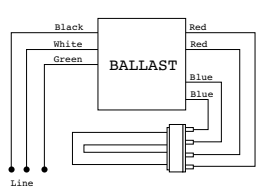

DIAGRAM 21

Mount lamp within 1" of grounded metal reflect

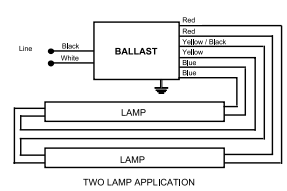
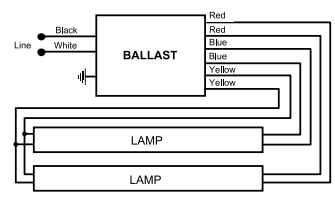
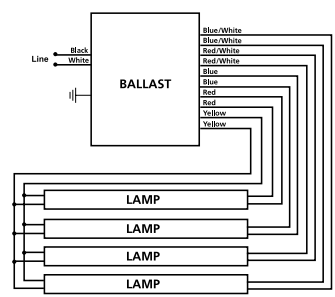

DIAGRAM 41



For one lamp operation, cap blue leads individually, insulate to 600V.

DIAGRAM A



For three lamp operation, cap Blue/White leads individually, insulate to 600V.

DIAGRAM B

Notes

Ballasts For High Intensity Discharge Lamps

Universal Means Higher Expectations In High Intensity Discharge

Universal Lighting Technologies ("Universal") offers a wide array of ballasts for High Intensity Discharge (HID) lamps. Applications include Metal Halide (MH), Pulse Start Metal Halide (PSMH), and High Pressure Sodium (HPS) lamps ranging from 35 to 1500 watts.

We're the technology leader in every category of HID ballasts. Our Universal Precise™ line is the latest innovation in magnetic core & coil technology in years.



Universal offers a complete line of HID ballasts for applications ranging from 35 - 1500 watts.

Product Overview

Core & Coil

Core & coil ballasts are used in over 90% of all HID fixtures. Universal's core & coil models are available for all HID lamp types, including single-, dual-, tri-, quad- and multi-volt designs. For added versatility and reduced inventory costs, Universal has also introduced the industry's first Multi-5™ ballast (120, 208, 240, 277, or 480 volt), featuring a 480-volt tap on a conventional quad-tap ballast.

Our core & coil models are ideal for a wide variety of lighting applications, including factories, warehouses, gymnasiums and retail stores. All these ballasts feature precision-wound coils, ensuring even heat dissipation and the highest electrical integrity.

Universal's Universal Precise™ is the next generation in core & coil technology, featuring a smaller, light-weight design and improved temperature performance. Universal Precise™ fits virtually all applications, and has no exposed live metal parts. There are no plastic extrusions, which prevents breakage during shipping. Color-coded leads make installation easy.

50 Hertz

Universal offers 50 Hz core & coil ballasts to meet the rapid growth in demand in international markets. Our ballasts are available for 220, 230, and 240 volt electrical systems.

F-Can

These ballasts are used primarily for indoor downlighting applications where quiet operation is essential. All the components of these ballasts are enclosed in a fluorescent-style ballast can and are thermally protected.



F-Can Ballasts



Core and Coil Ballasts



HID Ballast Kits

Product Overview

For maximum safety and reliability, all Universal capacitors come with built-in bleed resistors (patented by Universal) and approved by CSA (CSA file #LR51331, metal cases only). Environmental safety is assured by use of biodegradable, nontoxic (no PCBs) dielectric fluid (soybean oil), patented by Universal for use in capacitors. Dry-film capacitors do not include protective devices. Since they can fail in a hazardous manner, it is the responsibility of the purchaser to take appropriate precautions.

Capacitors

Universal has a comprehensive line of capacitors in metal cases (up to 525V ratings) and plastic cases (up to 400V ratings). All Universal capacitors are designed for 60,000 hours of continuous life. They're exceptionally reliable because we put them through accelerated life testing at 125% rated voltage and rated temperature +10°C.

Universal capacitors are normally packaged with ballasts. They may also be ordered separately, bulk packaged, or individually boxed with the suffix "BH" (metal cases only). Capacitor weights vary from 1/4 lb. to 1 lb. each.

Dry Capacitors

Type "P" plastic case capacitors described in this section are dry and do NOT contain safety interrupters (or oil). Plastic cases are UL rated "94V-0" (for use up to 100°C maximum). Type "P" capacitors are supplied with stranded copper wire leads 8 inches long (18 awg, with 150°C rated insulation). Capacitor rolls are sealed inside plastic cases using epoxy. Design and testing of Universal capacitors follow specifications in Electronic Industries Association (EIA) Standard 456-A, titled "Metalized Film Dielectric Capacitors for Alternating Current Application."

"P" capacitors are designed and rated for continuous duty AC voltages below 400VAC @ 50 or 60 Hz. Capacitors used with HID ballasts at voltages above 400VAC should contain interrupters (available from Universal in oval "MF" and round "RMF" oil-filled metal cases).

Plastic Dry Type Capacitors

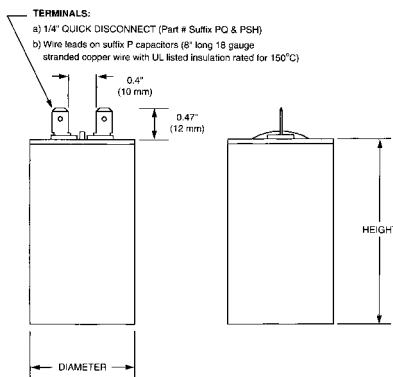

Metal and Oil Filled Capacitors

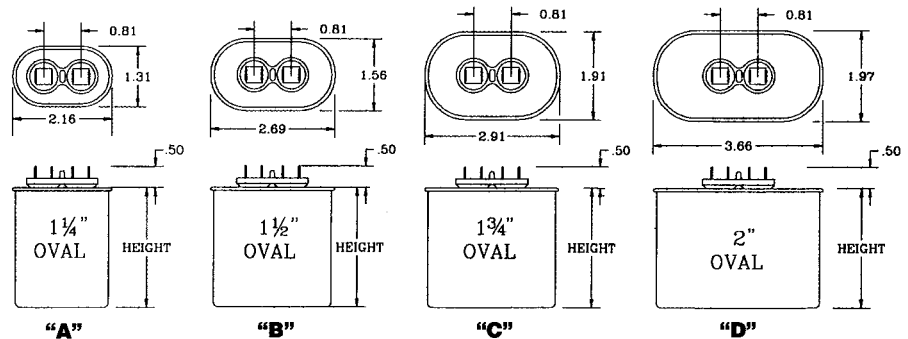

WARNING

Plastic case capacitors can "short circuit" & burn (they do not contain "interrupters"). Protection is the user's responsibility. Disconnect all input power before installing or removing, to prevent electrical shocks.

Protective Device (Only in metal cases)

Protective device to prevent case rupture

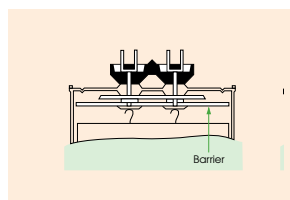

Normal Position of Protective Device

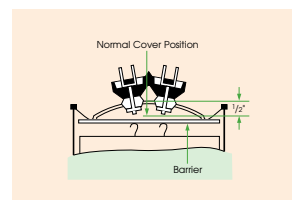

Position of Protective Device After Activation

Oil-Filled Capacitors

μ F	VACr	Part #	Case	Ht (")	μ F	VACr	Part #	Case	Ht (")
5.0	300	005-1466-BH	1.25 oval	2.2	22.5	300	005-1419-BH	1.50 oval	3.5
6.0	300	005-1561-BH	1.25 oval	2.2	24.0	360	005-3160-BH	1.75 oval	3.1
7.0	300	005-1410-BH	1.25 oval	2.2	24.0	400	005-2664-BH	1.75 oval	3.1
8.0	330	005-1411-BH	1.25 oval	2.2	24.0	480	005-2779-BH	1.75 oval	3.9
10.0	330	005-1413-BH	1.25 oval	2.7	24.5	300	005-3278-BH	1.75 oval	2.7
10.0	400	005-1184-BH	1.50 oval	2.7	26.0	330	005-2669-BH	1.75 oval	3.1
10.0	400	005-2167-BH	1.75 dia	2.9	26.0	525	005-2776-BH	1.75 oval	4.3
12.0	300	005-1467-BH	1.25 oval	3.1	28.0	240	005-1886-BH	1.75 dia	2.3
12.0	400	005-2799-BH	1.50 oval	2.7	28.0	300	005-1468-BH	1.75 oval	3.1
12.0	440	005-1464-BH	1.50 oval	3.1	28.0	425	005-1799-BH	1.75 oval	3.9
13.0	300	005-1414-BH	1.25 oval	3.1	30.0	440	005-1475-BH	1.75 oval	3.9
14.0	240	005-1884-BH	1.75 dia	2.3	32.0	300	005-2351-BH	1.75 oval	3.1
14.0	300	005-1415-BH	1.50 oval	2.7	32.0	525	005-1474-BH	2.00 oval	3.9
15.0	400	005-1185-BH	1.75 oval	2.7	33.0	300	005-1470-BH	1.75 oval	3.1
16.0	300	005-1498-BH	1.50 oval	2.7	35.0	330	005-1421-BH	1.75 oval	3.1
17.5	300	005-1417-BH	1.50 oval	3.1	36.0	525	005-2793-BH	2.00 oval	4.3
18.0	440	005-1401-BH	1.75 oval	3.1	40.0	240	005-1887-BH	1.75 dia	2.7
18.5	330	005-1796-BH	1.50 oval	3.1	40.0	300	005-1768-BH	1.75 oval	3.9
20.0	240	005-1885-BH	1.75 dia	2.3	48.0	330	005-1422-BH	1.75 oval	3.9
20.0	330	005-1418-BH	1.50 oval	3.1	52.0	240	005-1888-BH	2.00 dia	2.9
20.5	400	005-3262-BH	1.75 oval	3.1	55.0	240	005-1594-BH	1.75 oval	3.5
21.0	525	005-1495-BH	1.75 oval	3.9	55.0	300	005-2117-BH	1.75 oval	3.9

Dry Capacitors

-- µF	V	100°C Rated Part #	DIA (") L (")		-- µF	V	100°C Rated Part #	DIA (") L (")	
5.0	280	R17058511-BH	1.26	2.36	20.0	170	R17058501-BH	1.65	2.83
5.0	280	R17058512-BH	1.26	2.83	20.0	280	R17058526-BH	1.65	3.82
5.0	330	R17058539-BH	1.26	2.24	20.0	330			
6.0	280	R17058513-BH	1.26	2.36	20.0	400	R17058564-BH	1.85	3.82
6.0	280	R17058514-BH	1.26	2.83	20.5	400	R17058565-BH	1.85	3.82
7.0	280	R17058515-BH	1.65	2.83	21.0	400	R17058567-BH	1.85	3.82
8.0	300	R17058535-BH	1.65	2.83	22.0	400	R17058569-BH	1.85	3.82
8.0	330	R17058541-BH	1.65	2.83	22.5	280	R17058527-BH	1.65	3.15
10.0	280	R17058517-BH	1.26	2.83	22.5	280	R17058528-BH	1.65	3.82
10.0	280	R17058519-BH	1.65	2.83	24.0	280	R17058529-BH	1.65	3.82
10.0	330	R17058578-BH	1.65	2.83	24.0	400	R17058571-BH	1.85	3.82
10.0	400	R17058555-BH	1.65	2.83	24.0	400			
10.0	400	R17058557-BH	1.65	3.82	24.5	330	R17058552-BH	1.65	4.76
11.0	400	R17058558-BH	1.65	2.83	26.0	300	R17058537-BH	1.65	4.76
12.0	300	R17058536-BH	1.65	2.83	26.5	400	R17058574-BH	1.85	4.76
12.0	330	R17058543-BH	1.65	2.83	28.0	170	R17058502-BH	1.65	2.83
12.0	400	R17058580-BH	1.65	3.82	28.0	280	R17058530-BH	1.65	4.76
13.0	330				28.0	330	R17058553-BH	1.85	3.82
14.0	170	R17058500-BH	1.26	2.83	35.0	280	R17058531-BH	1.65	3.82
14.0	280	R17058520-BH	1.65	2.83	35.0	280	R17058532-BH	1.85	4.76
14.0	280	R17058520-BH	1.65	2.83	40.0	240	R17058505-BH	1.65	3.82
14.0	400	R17058560-BH	1.65	3.82	40.0	240	R17058506-BH	1.65	4.76
15.0	400	R17058562-BH	1.65	3.82	48.0	280	R17058533-BH	1.85	4.76
15.0	400	R17058563-BH	1.85	3.82	48.0	330	R17058554-BH	2.05	4.76
16.0	280	R17058522-BH	1.65	2.83	52.0	170	R17058503-BH	1.85	3.82
16.0	280	R17058522-BH	1.65	2.83	52.0	280	R17058534-BH	1.85	4.76
16.0	330	R17058547-BH	1.65	2.83	55.0	240	R17058507-BH	1.85	3.82
17.0	400	R17058588-BH	1.65	3.82	55.0	240	R17058509-BH	1.85	4.76
17.5	280	R17058523-BH	1.65	3.82	55.0	300	R17058538-BH	1.85	4.76

Bracket Reference Chart

CORE & COIL WELDED BRACKETS

All welded brackets are .093" thick.

Ref. Drawing B1

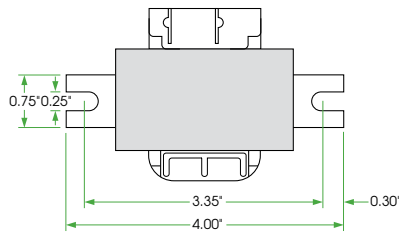

Ref. Drawing B2

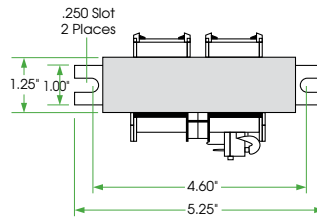

Ref. Drawing B1-A

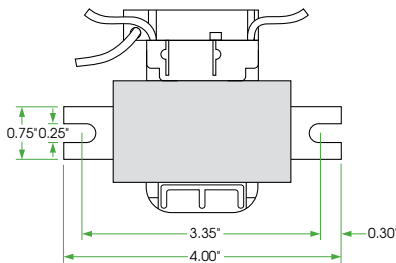

Ref. Drawing B3

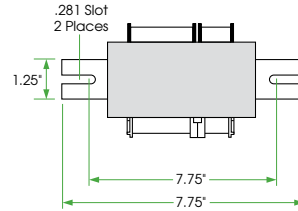

Ref. Drawing B1-B

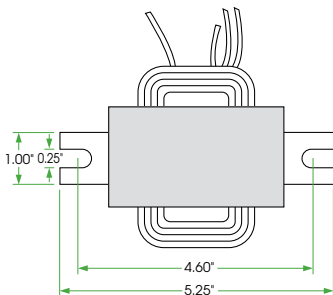

Ref. Drawing B4

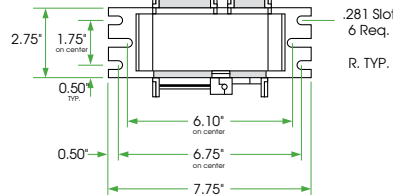

CORE & COIL ADJUSTABLE MOUNTING BRACKETS

Routinely supplied with replacement kits.

Ref. Drawing ADJ1

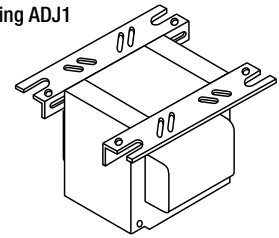

Ref. Drawing ADJ2

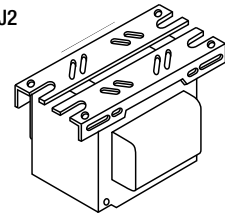

Ref. Drawing MB1

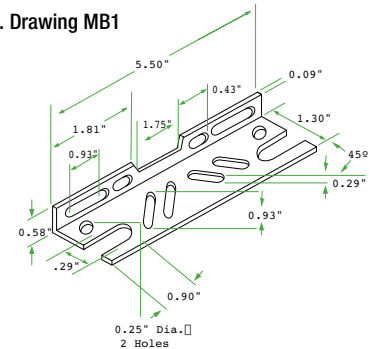

For use with:

- 50 to 175 watt Mercury, High Pressure Sodium and Metal Halide and some 250 watt Metal Halide

Ref. Drawing MB2

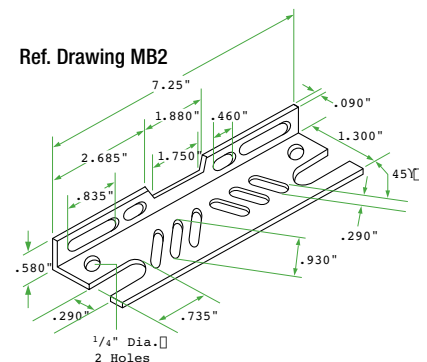

For use with:

- 250 to 1500 watt Metal Halide
- 250 to 1000 watt High Pressure Sodium and Mercury Vapor

Application And Operating Information

Underwriters' Laboratories, Inc. Acceptance

All F-Can and Weatherproof ballasts listed in this catalog are Underwriters' Laboratories, Inc. white card listed, except those for 347 volt operation. All Core & Coil and Potted Core & Coil ballasts listed in this catalog are Underwriters' Laboratories, Inc. yellow card listed (component recognized).

Ballast Replacement

Ballast replacement presents the possibility of exposure to potentially hazardous voltages and should be performed only by qualified personnel. All installation, inspection and maintenance should be performed only with the entire circuit power to fixture or equipment turned off. Installation shall be in accordance with National Electric Code.

Heat

A ballast, like any other electrical device, generates heat during normal operation. Planning for maximum heat dissipation with proper fixture design, installation planning and ballast selection will minimize the possibility of a heat-related problem arising. Excessive temperature will have an adverse effect on ballast life.

Normal temperature limits:

F-Can Ballasts

Maximum case temperature: 90°C

Potted Core & Coil Ballasts and
Core & Coil Ballasts

Insulation: Class 180°C

Maximum coil temperature: 165°C

(measured by change of resistance method)

All F-Can ballasts listed in this catalog are equipped with built-in automatic resetting internal thermal protection as a standard feature.

Whenever a ballast with thermal protection is used, it is imperative that the fixture/ballast/lamp combination be heat tested under actual or simulated installation conditions to assure that the ballast will not cycle. The resetting thermal protector functions as a thermostat which will open and temporarily deactivate the ballast when it exceeds the permissible

temperature. The ballast will continue to cycle until the cause of overheating is eliminated. If the ballast is defective, it must be replaced. If the cause is external, the ballast will resume normal operation after abnormal conditions are eliminated.

To attain normal ballast life, the maximum coil temperature of the ballast should not exceed the rating of the insulation system. A temperature increase of 10° C results in a 50% reduction of ballast life.

Low Ambient Temperature (cold)

As temperatures drop, less and less vaporized gas is available within the arc tube of a high intensity discharge lamp, thereby causing an increase in the open circuit voltage required to initiate an arc in the lamp, until a point is reached where the lamp cannot be started. The minimum temperature at which any ballast listed in this catalog will provide reliable starting is listed with the electrical characteristics.

Ballasts should be protected from weather, moisture, or other abnormal atmospheric conditions, unless specifically designed for use under adverse conditions.

Fusing

The purpose of fusing an HID ballast is to remove the ballast from the power line in the event of a ballast system failure. A fuse does not protect the ballast from failing.

Because the temperature in the ballast compartment is high, typically 90°C, fuse ratings are specified at 25°C, and that this rating declines as the temperature increases, HID fuse recommendations are made between 2 and 3 times the maximum current the ballast will draw during all normal conditions.

Fast-blow fuses should not be used due to the possibility of high inrush currents. These currents are due to the fact that the power can be applied at any point in the AC voltage waveform. Standard and slow-blow are acceptable.

When using the 120V tap for auxiliary lighting, a slow-blow fuse should be used to protect the ballast from damage from a fault in the auxiliary lighting circuit.

REMOTE MOUNTING DISTANCE

Maximum Length in Feet for Remote Mounting of HID Ballasts to Lamp

ANSI	Lamp Type	Watts	12 GA	14 GA	16 GA	18 GA
M57	Metal Halide	175	272	171	107	67
M58	Metal Halide	250	194	122	77	48
M59	Metal Halide	400	132	83	52	33
M47	Metal Halide	1000	196	123	77	48
M48	Metal Halide	1500	146	92	58	36

For proper installation, insure that remote ballasts are properly vented and mounted to a heat-dissipating surface.

Application And Operating Information

Sound

High intensity discharge lamp ballasts, like all electromagnetic devices, produce noise, or “hum.” It is the degree of noise which determines the existence of a problem. Ballast noise will only be noticeable when it exceeds the ambient sound level of the installation. It is obvious that a ballast designed primarily for outdoor or factory use would not be suitable in an office environment.

The vast improvements in all high intensity discharge lamps and ballasts, and their excellent energy efficiency, have made them viable options for many indoor applications. The ballasts being considered should be carefully analyzed to insure that there will not be an objectionable level of ballast noise.

All F-Can ballasts listed in this catalog are “Sound Rated” to aid in the selection of a ballast which is proper for the environment in which it will operate.

Potted Core & Coil ballasts are also designed to operate at reduced sound levels, generally several decibels lower than a standard Core & Coil ballast. Core & Coil ballasts are not sound rated.

In situations where light output necessitates using a ballast with a sound rating or noise level not normally acceptable, the ballast should be remotely mounted. Note, however, that not all ballasts listed in this catalog are designed or recommended for remote mounting.

Polarity

Polarity refers to the proper connection of ballast lead wires to line wires. To aid you in making a correct installation, Universal ballast leads are color-coded for easy identification. The white or yellow ballast lead is to be connected to the neutral or common. Choose the appropriate ballast voltage lead to connect to the line.

Grounding

Ballasts and capacitors or starters in metallic casings must always be grounded. Ballasts and components may be grounded to the fixture or otherwise connected to ground. It would be hazardous to make contact with an ungrounded fixture, ballast or other electrical component while in operation.

Operating Line Voltage Limits

To receive the full benefits of rated lamp output and to prolong ballast life, it is essential that the voltage supplied to an installation be maintained within the prescribed limits.

In general, the line voltage supplied to a lag type ballast (reactor or high reactance autotransformer) should be maintained within 5% of the voltage for which the ballast is rated. The line voltage to lead type ballasts (constant wattage autotransformer or constant wattage isolated) should be maintained within 10%.

Subjecting a ballast to excessive voltage for an extended period of time results in the deterioration of the coil insulation. This insulation breakdown will cause early ballast failure.

Low voltage has no damaging effect on the ballast. It could, however, have an adverse effect on lamp performance and starting dependability.

Maintenance

Selecting and installing an adequate and efficient lighting system means nothing if it is not properly maintained. Maintenance must always be considered as part of the life cycle cost of any high intensity discharge lighting installation in order to assure the continued performance of the system as originally specified.

First and foremost in importance is proper lamp maintenance. High intensity discharge lamps do not “burn out” like an incandescent bulb, but rather, undergo changes within the arc tube which prevent the lamp from starting properly, warming up and producing full light output. The beginning of difficulties such as these generally indicates the end of a lamp’s useful life. Also, a dead lamp left in a fixture can be very damaging to the ignitor in systems which utilize them. To overcome this problem, Universal offers automatic shutoff ignitors, which are described in the ignitor section of this catalog.

Application And Operating Information

In difficult locations, group replacement of all the lamps, working or not, is often more economical and convenient than spot replacement. The same, of course, applies to ballasts which might be approaching the end of their life. Only you can decide what is right for your lighting system, but what is important is that you have a maintenance program.

Periodic cleaning of the fixtures' lenses and reflectors is also important in maintaining proper light output. For indoor systems, maintenance of reflective surfaces, such as walls and ceilings, will also help assure proper levels of illumination.

STANDBY LIGHTING AND PACKAGING

Standby Lighting

To provide light during a high intensity discharge lamp's warmup period, or the cool-down period following a power interruption which has extinguished it, incandescent standby lighting can be incorporated. This is accomplished by use of a standby lighting device, or remote, that switches off an incandescent lamp incorporated into the fixture once an arc has been established, or reestablished, in the HID lamp. Generally, standby lighting devices operate on 120 volts, so a tap must be provided on ballasts designed to operate at higher line voltages.

The 120 volt terminal or lead on all Universal dual-, tri-, quad- and multi-volt ballasts can be used as a tap for standby lighting when the ballast is utilized for any of the higher voltages. Many single voltage ballasts are available with a 120 volt tap and are listed throughout the Core & Coil data section. Other single voltage ballasts may be available in this version. Consult our Customer Service Department for availability and price information.

Any connection to the 120 volt tap must be accomplished by means of a slow-blow fuse. This fuse will protect the ballast from abnormal conditions in the standby lamp circuit or its control device. The fuse should be located in the coolest place in the fixture (below 80°C). The recommended fuse amperage and maximum auxiliary lamp wattage are listed in this catalog for each ballast suitable

for standby lighting applications. Be sure to follow the wiring instructions of the standby lighting device manufacturer. All applicable requirements of the National Electrical Code must be met.

Packaging

Standard Pack

Universal's high intensity discharge lamp ballasts are routinely packed in easy-to-handle cartons containing from 1 to 20 units per carton, depending on the size and weight of the ballasts. Consult Customer Service for the number of "units per carton" for shipment with attached mounting brackets, capacitors (for high power factor units), and ignitors (if required). Other ordering criteria may cause packaging to vary.

Tray Pack

For the convenience of large quantity users who request it, Universal ballasts may be packed in trays. The number of units depends upon the size and weight of each ballast. These trays are large corrugated cartons with lids and sides that come off easily. This type of packaging affords Universal customers a savings of time and money on their own production costs. There are fewer cartons to open, break up and dispose of on the assembly line; warehouse handling is reduced and inventory control is easier. There is no additional charge for tray packing.

Individual Cartons

All Distributor Replacement Kits, Weatherproof, Potted Core & Coil and other larger ballasts are packaged in individual cartons.

Individual cartons serve a threefold purpose: as a display carton, a stock package, and a shipping container for the retail market. Individual cartons may be packed in master cartons, depending on weight and size.

Individual carton packaging may be available for other ballasts. Contact our Customer Service Department for availability and cost.

Nomenclature

UNIVERSAL PRECISE™

ABBREVIATIONS

CWA	Constant Wattage Autotransformer
CWI	Constant Wattage Isolated
ISO	Regulated Lag
R-HPF	Reactor—High Power Factor
R-NPF	Reactor—Normal Power Factor
HX-HPF	Lag Type — High Reactance Autotransformer—High Power Factor
HX-NPF	Lag Type — High Reactance Autotransformer—Normal Power Factor

UL Bench Top Rise Temperature Code

To facilitate UL inspection, the UL Bench Top Rise Temperature Code is shown on the Universal Core & Coil Ballast label as 1029X. 1029 is the UL Standard for HID Ballasts, and the X is the temperature code. If a fixture is UL listed for 1029D, then automatically all ballasts with an A, B, C or D temperature classification are acceptable for use within that same fixture.

UL Bench Top Rise Letter Code Temperature Range for Class H (180° C) Ballasts

A < 75°C	B 75°C < 80°C	C 80°C < 85°C
D 85°C < 90°C	E 90°C < 95°C	F 95°C < 100°C

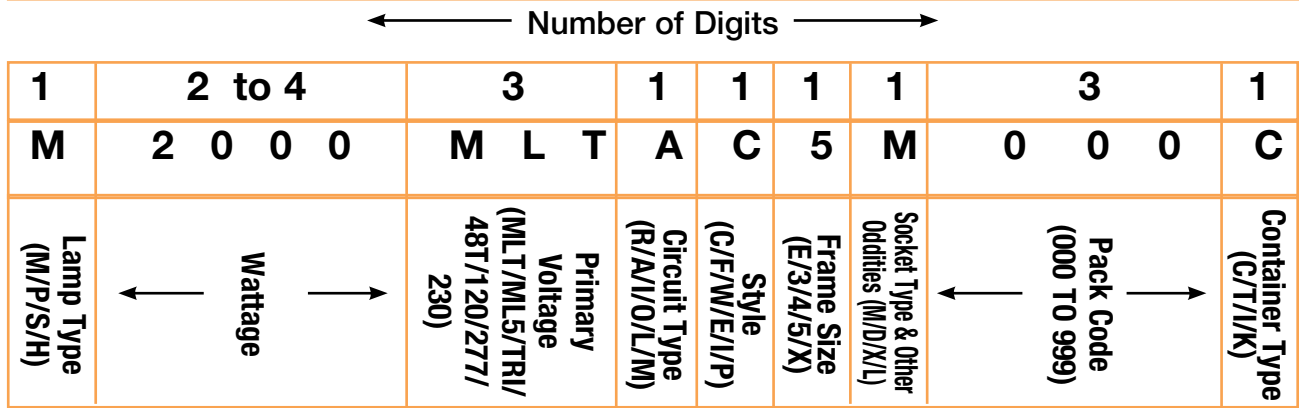

Field	Description
1	(M) Metal Halide, (P) Pulse Start Metal Halide, (S) High Pressure Sodium
2	35 to 1500 Watts (Varies from two to four digits)
3	(MLT) Quad, (ML5) Multi-5, (TRI) TriVolt, (48T) 480/120, (120) 120, (277) 277, (230) 230V/50Hz
4	(R) Reactor, (A) CWA, (I) CWI, (O) IsoReg, (L) High Reactance/Lag, (M) MagLag
5	(C), C&C, (F) F-Can, (W) Weatherproof, (E) Encased/Potted C&C (I) Indoor Encased
6	(E) E&l, (3) 3x4, (4) 4-3/4, (5) 5-3/4, (X) Non Core and Coil
7	(M) Mogul or Medium, (D) Double Ended, (L) Low Loss
8	Pack Code (000 to 999, per pack code listing)
9	(C) Carton, (T) Tray, (I) Individual, (K) Kit

Specifications

TYPICAL SPECIFICATIONS FOR HID BALLASTS

1. Ballasts shall be designed in accordance with all applicable ANSI specifications including ANSI C82.4.
2. The Core & Coil ballast shall be designed with class “H” (180°C) or higher insulation system and vacuum impregnated with a 100% solid based resin.
3. All coils shall be precision wound.
4. Core & Coil ballasts shall be designed to operate at least 180 cycles of 12 hours on and 12 hours off, with the lamp circuit in an open or short-circuited condition and without undue reduction in ballast life.
5. Core & Coil ballast and starter combinations shall be designed to provide a reliable lamp starting down to -40°C for High Pressure Sodium and Pulse Start Metal Halide and -30°C for Metal Halide and Mercury at minimum rated line voltage.
6. Manufacturer shall provide written warranty against defects in workmanship, including replacement, for two years from date of manufacture.

CAPACITORS

1. All capacitors will be provided with a self-contained internal bleeder resistor.
2. All oil-filled capacitors will be housed in corrosion-resistant steel cans and contain .25” quick disconnect terminals.
3. All capacitors will be supplied by ballast manufacturer.

IGNITORS

1. All ignitors will be epoxy-filled with either a plastic or aluminum external housing.
2. The ignitor shall be so designed to provide six months of lamp open circuit operation without failure.

KITS

1. All HID kits shall be precision wound to insure proper insulation.
2. All HID kits shall be pre-wired.
3. All HID kits shall be built with color-coded leads.
4. All HID kits are to be UL and CSA recognized following the guidelines found in UL 1029 and CAN/CSA-22.2 No. 74-92 (part 2 and 3).
5. Universal Model _____ (or approved equal).

Distributor Replacement Kits

Universal's HID distributor replacement kits contain the appropriate core & coil, a properly rated capacitor, and all other components required for ballast replacement. Our kits are the quickest and easiest to install of any on the market, thanks to unique design features like:

- Prewired capacitor and ignitor (if required) to save installation time and reduce wiring errors.
- Color-coded leads to reduce risk of incorrect wiring inside the fixture.
- Features that exceed UL standards, including capacitors that offer trip fault protection.
- Simple installation instructions and troubleshooting tips.
- UPS shippable box.

Our kit offerings include many quad voltage (120, 208, 240, or 277 volt) and 480 volt core & coil ballasts, as well as the new Multi-5 five-voltage ballast. 480 volt ballasts are equipped with a 120 volt tap to accommodate stand by lighting.

Also available for Metal Halide and High Pressure Sodium applications, Universal Lighting's Multi-5™ Ballast-Lamp Replacement Kit. This easy to carry convenient all-in-one kit ensures ballast lamp compatibility.

Distributor replacement kit cartons are packaged in master cartons in quantities from 1 to 6 units. Master carton quantities can be found on Universal's list and distributor price sheets.

Quad, 480 Volt, Multi-5™ and Multi-5™ Uni-Pak™ Distributor Replacement Kits

LampType	Wattage	Voltage	Frame Size	Old Part Number	New Part Number
Metal Halide	175	120/208/240/277	3 x 4	1130-91R-500K	M175MLTAC3M500K
	175	Multi-5	3 x 4	New	M175ML5AC3M500K
	175	Multi-5™ Uni-Pak™	3 x 4	New	M175ML5AC3M555K
	175	480-120	3 x 4	1130-31-500K	M17548TAC3M500K
	250	120/208/240/277	3 x 4	1130-92-500K	M250MLTAC3M500K
	250	Multi-5	3 x 4	New	M250ML5AC3M500K
	250	Multi-5™ Uni-Pak™	3 x 4	New	M250ML5AC3M555K
	250	480-120	3 x 4	1130-32-500K	M25048TAC3M500K
	250	120/208/240/277	4.25 x 4.75	1130-92R-500K	M250MLTAC4M500K
	250	Multi-5	4.25 x 4.75	New	M250ML5AC4M500K
	250	Multi-5™ Uni-Pak™	4.25 x 4.75	New	M250ML5AC4M555K
	250	480-120	4.25 x 4.75	1130-32R-500K	M25048TAC4M500K
	400	120/208/240/277	4.25 x 4.75	1130-93U-500K	M400MLTAC4M500K
	400	Multi-5	4.25 x 4.75	1130-826S-500K	M400ML5AC4M500K
	400	Multi-5™ Uni-Pak™	4.25 x 4.75	New	M400ML5AC4M555K
	400	480-120	4.25 x 4.75	1130-33R-500K	M40048TAC4M500K
	1000	120/208/240/277	4.25 x 5.75	1130-97-500K	M1000MLTAC5M500K
	1000	Multi-5	4.25 x 5.75	New	M1000ML5AC5M500K
	1000	Multi-5™ Uni-Pak™	4.25 x 5.75	New	M1000ML5AC5M555K
	1000	480-120	4.25 x 5.75	1130-57-500K	M100048TAC5M500K
1500	120/208/240/277	4.25 x 5.75	1130-99R-500K	M1500MLTAC5M500K	
1500	480-120	4.25 x 5.75	1130-69R-500K	M150048TAC5M500K	

Distributor Replacement Kits

Quad, 480 Volt, Multi-5™ and Multi-5™ Uni-Pak™ Distributor Replacement Kits

LampType	Wattage	Voltage	Frame Size	Old Part Number	New Part Number
Pulse Start Metal Halide	35	120/208/240/277	3 x 4	New	M35MLTLC3M500K
	50	120/208/240/277	3 x 4	11310-95-500K	M50MLTLC3M500K
	70	120/208/240/277	3 x 4	11310-510-500K	M70MLTLC3M500K
	70	480-120	3 x 4	New	M7048TLC3M500K
	70	120/208/240/277	3 x 4	New	M70MLTLC3D500K
	100	120/208/240/277	3 x 4	M100MLTLC3M	M100MLTLC3O500K
	100	120/208/240/277	3 x 4	New	M100MLTLC3D500K
	100	480-120	3 x 4	New	M10048TLC3M500K
	150	120/208/240/277	3 x 4	11310-543-500K	M150MLTLC3M500K
	150	120/208/240/277	3 x 4	New	M150MLTAC3M500K
	150	120/208/240/277	3 x 4	New	M150MLTLC3D500K
	150	480-120	3 x 4	New	M15048TLC3M500K
	175	120/208/240/277	3 x 4	New	P175MLTAC3M500K
	175	120/208/240/277	3 x 4	New	P175MLTAC3L500K
	175	Multi-5	3 x 4	New	P175ML5AC3M500K
	175	120/208/240/277	4.25 x 5.75	New	P175MLTAC4L500K
	175	480-120	3 x 4	New	P17548TAC3L500K
	175	480-120	4.25 x 5.75	New	P17548TAC4L500K
	200	120/208/240/277	3 x 4	New	P200MLTAC3L500K
	200	Multi-5	3 x 4	New	P200ML5AC3M500K
	200	480-120	3 x 4	New	P20048TAC3L500K
	250	120/208/240/277	4.25 x 4.75	New	P250MLTAC4L500K
	250	Multi-5	4.25 x 4.75	New	P250ML5AC4L500K
	250	480-120	4.25 x 4.75	New	P25048TAC4L500K
	320	120/208/240/277	4.25 x 4.75	1130-827-500K	P320MLTAC4O500K
	320	Multi-5	4.25 x 4.75	New	P320ML5AC4M500K
	320	Multi-5	4.25 x 4.75	New	P320ML5AC4L500K
	320	480-120	4.25 x 4.75	New	P32048TAC4L500K
	350	120/208/240/277	4.25 x 4.75	1130-622-500K	P350MLTAC4M500K
	350	Multi-5	4.25 x 4.75	P350ML5AC4M	P350ML5AC4O500K
	350	Multi-5	4.25 x 4.75	New	P350ML5AC4L500K
	350	480-120	4.25 x 4.75	New	P35048TAC4L500K
	400	120/208/240/277	4.25 x 4.75	1130-829-500K	P400MLTAC4L500K
	400	Multi-5	4.25 x 4.75	New	P400ML5AC4L500K
	400	480-120	4.25 x 4.75	New	P40048TAC4L500K
	450	120/208/240/277	4.25 x 4.75	New	P450MLTAC4L500K
	450	Multi-5	4.25 x 4.75	New	P450ML5AC4L500K
	450	480-120	4.25 x 4.75	New	P45048TAC4L500K
	750	120/208/240/277	4.25 x 5.75	New	P750MLTAC5M500K
	750	Multi-5	4.25 x 5.75	New	P750ML5AC5M500K
	750	480-120	4.25 x 5.75	New	P75048TAC5M500K
	875	120/208/240/277	4.25 x 5.75	New	P875MLTAC5M500K
1000	120/208/240/277	4.25 x 5.75	New	P1000MLTAC5M500K	
1000	Multi-5	4.25 x 5.75	New	P1000ML5AC5M500K	

Distributor Replacement Kits

Quad, 480 Volt, Multi-5™ and Multi-5™ Uni-Pak™ Distributor Replacement Kits

LampType	Wattage	Voltage	Frame Size	Old Part Number	New Part Number
H.P.S.	50	120/208/240/277	3 x 4	12310-95-500K	S50MLTLC3M500K
	70	120/208/240/277	3 x 4	12310-153-500K	S70MLTLC3M500K
	70	480-120	3 x 4	12310-148R-500K	S7048TLC3M500K
	100	120/208/240/277	3 x 4	12310-90-500K	S100MLTLC3M500K
	100	480-120	3 x 4	12310-30R-500K	S10048TLC3M500K
	150	120/208/240/277	3 x 4	S150MLTLC3M	S150MLTLC3O500K
	150	480-120	3 x 4	12310-160S-500K	S15048TLC3M500K
	200	120/208/240/277	4.25 x 4.75	New	S200MLTAC4M500K
	200	480-120	4.25 x 4.75	New	S20048TAC4M500K
	250	Multi-5	4.25 x 4.75	S250ML5AC4M	S250ML5AC4O500K
	250	120/208/240/277	4.25 x 4.75	1230-92S-500K	S250MLTAC4M500K
	250	480-120	4.25 x 4.75	1230-32S-500K	S25048TAC4M500K
	250	Multi-5™ Uni-Pak™	4.25 x 4.75	New	S250ML5AC4M555K
	400	Multi-5	4.25 x 4.75	New	S400ML5AC4M500K
	400	120/208/240/277	4.25 x 4.75	1230-93U-500K	S400MLTAC4M500K
	400	480-120	4.25 x 4.75	1230-33U-500K	S40048TAC4M500K
	400	Multi-5	4.25 x 5.75	New	S400ML5AC5M500K
	400	120/208/240/277	4.25 x 5.75	1230-93S-500K	S400MLTAC5M500K
	400	480-120	4.25 x 5.75	1230-33S-500K	S40048TAC5M500K
	400	Multi-5™ Uni-Pak™	4.25 x 4.75	New	S400ML5AC4M555K
	400	Multi-5™ Uni-Pak™	4.25 x 4.75	New	S400ML5AC5M555K
	600	120/208/240/277	4.25 x 5.75	New	S600MLTAC5M500K
	1000	120/208/240/277	4.25 x 5.75	1230-97S-500K	S1000MLTAC5M500K
	1000	Multi-5	4.25 x 5.75	New	S1000ML5AC5M500K
	1000	Multi-5™ Uni-Pak™	4.25 x 5.75	New	S1000ML5AC5M555K
	1000	480-120	4.25 x 5.75	1230-57S-500K	S100048TAC5M500K

Distributor Replacement Kits



Canadian Tri-Tap Distributor Replacement Kits

LampType	Wattage	Voltage	Frame Size	Old Part Number	New Part Number
Metal Halide	175	120/277/347	3 x 4	1130-605-502K	M175TRIAC30502K
	250	120/277/347	3 x 4	New	M250TRIAC3M502K
	250	120/277/347	4.25 x 4.75	1130-593R-502K	M250TRIAC4M502K
	400	120/277/347	4.25 x 4.75	M400TRIAC4M	M400TRIAC4O502K
	1000	120/277/347	4.25 x 5.75	1130-598-502K	M1000TRIAC5M502K
	1500	120/277/347	4.25 x 5.75	1130-599-502K	M1500TRIAC5M502K
Pulse Start Metal Halide	35	120/277/347	3 x 4	New	M35TRILC3M502K
	50	120/277/347	3 x 4	New	M50TRILC3M502K
	70	120/277/347	3 x 4	11310-604-502K	M70TRILC3M502K
	100	120/277/347	3 x 4	11310-584-502K	M100TRILC3M502K
	150	120/277/347	3 x 4	11310-590-502K	M150TRILC3M502K
	175	120/277/347	3 x 4	New	P175TRIAC3M502K
	200	120/277/347	3 x 4	New	P200TRIAC3M502K
	250	120/277/347	4.25 x 4.75	New	P250TRIAC4M502K
	320	120/277/347	4.25 x 4.75	New	P320TRIAC4M502K
	350	120/277/347	4.25 x 4.75	New	P350TRIAC4M502K
	400	120/277/347	4.25 x 4.75	New	P400TRIAC4M502K
	750	120/277/347	4.25 x 5.75	New	P750TRIAC5M502K
	70	120/277/347	3 x 4	12310-579-502K	S70TRILC3M502K
H.P.S.	100	120/277/347	3 x 4	12310-584-502K	S100TRILC3M502K
	150	120/277/347	3 x 4	12310-588-502K	S150TRILC3M502K
	200	120/277/347	4.25 x 4.75	-	S200TRILC4M502K
	250	120/277/347	4.25 x 4.75	1230-593S-502K	S250TRIAC4M502K
	400	120/277/347	4.25 x 4.75	1230-595U-502K	S400TRIAC4M502K
	400	120/277/347	4.25 x 5.75	1230-595S-502K	S400TRIAC5M502K
	1000	120/277/347	4.25 x 5.75	1230-598S-502K	S1000TRIAC5M502K

HID CORE & COIL BALLASTS
METAL HALIDE

- 60 Hz
- Minimum starting temperature: -30° C
- Normal and High Power Factor models available

Input Volts	Catalog* Number	Circuit Type	Watts Input	Max Input Current	Nom Open Circuit Voltage	Fuse Rating	Wir Dia	Dimensions				Capacitor				Total Weight (lbs.)	Ignitor			
								Ref Dwg	A	B	µF	Min Volt	Dry Film		Oil Filled		Catalog Number	Max Distance to lamp (ft)	UL Bench Top Rise	
(1) 175 WATT M57, M107 METAL HALIDE LAMP																				
120 or	M175TRIAC30	CWA	211	2.15	305	5	3	PC1	2.45	3.75	10	400	1.65	3.82	1.56x2.69	2.7	6.8	n/a	n/a	C
277 or				0.95		2														
347				0.75		2														
120 or	M175MLTAC3M	CWA	213	1.90	305	5	1	PC1	2.2	3.6	10	400	1.65	2.83	1.56x2.69	2.7	6.1	n/a	n/a	A
208 or				1.10		3														
240 or				0.95		3														
277				0.85		2														
120 or	M175ML5AC3M	CWA	208	1.90	300	8	2	PC1	2.3	3.60	10	400	1.65	2.83	1.56x2.69	2.7	6.75	n/a	n/a	B
208 or				1.10		5														
240 or				0.95		3														
277 or				0.85		3														
480				0.50		2														
480	M17548TAC3M	CWA	210	0.51	315	2	4	PC1	2.0	3.3	10	400	1.65	2.83	1.56x2.69	2.7	5.6	n/a	n/a	D
(1) 250 WATT M58 METAL HALIDE LAMP - 4" Frame																				
120 or	M250TRIAC3M	CWA	295	2.8	320	8	3	PC1	3.0	4.35	15	400	1.65	3.82	1.91x2.91	2.7	8.0	n/a	n/a	B
277 or				1.20		3														
347				0.95		3														
120 or	M250MLTAC3M	CWA	297	2.60	315	8	1	PC1	3.0	4.25	15	400	1.65	3.82	1.91x2.91	2.7	9.0	n/a	n/a	D
208 or				1.50		5														
240 or				1.30		4														
277				1.10		3														
120 or	M250ML5AC3M	CWA	295	2.50	285	8	2	PC1	3.0	4.5	15	400	1.65	3.82	1.91x2.91	2.7	9.2	n/a	n/a	A
208 or				1.40		5														
240 or				1.25		4														
277 or				1.10		3														
480				0.65		2														
347	M250347AC3M	CWA	295	0.95	320	3	6	PC1	3.0	4.35	15	400	1.65	3.82	1.91x2.91	2.7	8.0	n/a	n/a	D
480	M25048TAC3M	CWA	292	0.64	320	2	4	PC1	3.0	4.3	15	400	1.65	3.82	1.91x2.91	2.7	9.0	n/a	n/a	D

³ Capacitors are available as an option for high power factor operation.

See page 4-19 for Reference Drawings and Wiring Diagrams.

HID CORE & COIL BALLASTS

METAL HALIDE

- 60 Hz
- Minimum starting temperature: -30° C
- High Power Factor models available
- Feature CWA design

MH
250-400
WATT

Input Volts	Catalog* Number	Circuit Type	Watts Input	Max Input Current	Nom Open Circuit Voltage	Fuse Rating	Wir Dia	Dimensions			Capacitor				Total Weight (lbs.)	Ignitor				
								Ref Dwg	A	B	µF	Min Volt	Dry Film			Oil Filled		Catalog Number	Max Distance to lamp (ft)	UL Bench Top Rise
(1) 250 WATT M58 METAL HALIDE LAMP - 4.75" Frame																				
120 or 277 or 347	M250TRIAC4M	CWA	290	3.05	305	3	3	PC2	1.63	3.63	15	400	1.65	3.82	1.91x2.91	2.7	9.5	n/a	n/a	B
				1.25																
				1.05																
120 or 208 or 240 or 277	M250MLTAC4M	CWA	290	2.40	310	5	1	PC2	3.35	3.53	15	400	1.65	3.82	1.91x2.91	2.7	8.0	n/a	n/a	B
				1.40																
				1.20																
				1.05																
120 or 208 or 240 or 277 or 480	M250ML5AC4M	CWA	290	2.42	300	4	2	PC2	1.82	3.62	15	360	1.65	3.82	1.91x2.91	2.7	10.8	n/a	n/a	A
				1.40																
				1.20																
				1.00																
				0.60																
480	M25048TAC4M	CWA	290	0.61	300	2	4	PC2	1.82	3.62	15	360	1.65	3.82	1.91x2.91	2.7	10.8	n/a	n/a	B
(1) 400 WATT M59 METAL HALIDE LAMP																				
120 or 277 or 347	M400120AC4M	CWA	454	4.00	300	10	5	PC2	2.0	3.86	24	360	1.85	3.82	1.91x2.91	3.1	9.3	n/a	n/a	E
				3.90																
				1.70																
120 or 208 or 240 or 277	M400TRIAC40	CWA	455	1.35	295	5	3	PC2	2.15	3.90	24	360	1.85	3.82	1.91x2.91	3.1	10.5	n/a	n/a	D
				4.00																
				2.30																
				2.00																
120 or 208 or 240 or 277	M400MLTAC4M	CWA	458	4.00	300	8	1	PC2	2.0	3.86	24	360	1.85	3.82	1.91x2.91	3.1	10.0	n/a	n/a	E
				2.30																
				2.00																
				1.70																
				1.50																
120 or 208 or 240 or 277 or 480	M400ML5AC4M	CWA	458	4.00	300	5	2	PC2	2.0	3.86	24	360	1.85	3.82	1.91x2.91	3.1	11.0	n/a	n/a	E
				2.30																
				1.70																
				1.50																
				1.00																
480	M40048TAC4M	CWA	458	1.00	300	3	4	PC2	2.0	3.9	24	360	1.85	3.82	1.91x2.91	3.1	11.0	n/a	n/a	E

See page 4-19 for Reference Drawings and Wiring Diagrams.

HID CORE & COIL BALLASTS
METAL HALIDE-
FEATURING MULTI-5™

- 60 HZ.
- Minimum Starting Temperature: -30° C
- Feature CWA Design

Input Volts	Catalog* Number	Circuit Type	Watts Input	Max Input Current	Nom Open Circuit Voltage	Fuse Rating	Wir Dia	Dimensions			Capacitor				Total Weight (lbs.)	Ignitor		UL Bench Top Rise		
								Ref Dwg	A	B	µF	Min Volt	Dry Film			Oil Filled			Catalog Number	Max Distance to lamp (ft)
(1) 1000 WATT M47 METAL HALIDE LAMP																				
120	M1000120AC5M	CWA	1080	9.00	425	23	5	PC3	2.9	4.75	24	480	n/a	n/a	1.91x2.91	3.9	18.0	n/a	n/a	D
120 or				9.00		20														D
277 or	M1000TRIAC5M	CWA	1080	3.90	435	10	3	PC3	3.0	4.95	24	480	n/a	n/a	1.91x2.91	3.9	19.0	n/a	n/a	D
347				3.20		8														E
120 or				8.95		20														
208 or	M1000MLTAC5M	CWA	1080	5.15	425	15	1	PC3	2.9	5.05	24	480	n/a	n/a	1.91x2.91	3.9	22.0	n/a	n/a	D
240 or				4.50		10														
277				3.90		10														
120 or				9.15		20														F
208 or				5.25		15														E
240 or	M1000ML5AC5M	CWA	1080	4.55	420	10	2	PC3	2.9	5.05	24	480	n/a	n/a	1.91x2.91	3.9	22.0	n/a	n/a	E
277 or				3.95		10														E
480				2.30		6														E
480	M100048TAC5M	CWA	1080	2.30	410	6	4	PC3	2.85	4.75	24	480	n/a	n/a	1.91x2.91	3.9	22.0	n/a	n/a	D
(1) 1500 WATT M48 METAL HALIDE LAMP																				
120 or				13.70		40														
277 or	M1500TRIAC5M	CWA	1610	6.00	460	20	17	PC3	4.38	6.38	32	525	n/a	n/a	1.96x3.65	3.88	29.5	n/a	n/a	G
347				4.70		15														
120 or				14.30		40														F
208 or	M1500MLTAC5M	CWA	1615	8.30	455	25	48	PC3	4.4	6.4	32	525	n/a	n/a	1.96x3.65	3.88	30.0	n/a	n/a	G
240 or				7.20		20														F
277				6.20		20														E
480	M150048TAC5M	CWA	1620	3.50	445	10	15	PC3	4.4	6.4	32	525	n/a	n/a	1.96x3.65	3.88	30.0	n/a	n/a	E

**See page 4-19 for Reference
Drawings and Wiring Diagrams.**

HID CORE & COIL BALLASTS METAL HALIDE

MH

DESCRIPTION	SUFFIX *
For Ballast Only	000
For Bracket Only (see pg. 5-7)	200
For Capacitor Only (see pg. 5-5, 5-6)	500
For Distributor Replacement Kit (see pg. 5-13 thru 5-15)	500K
For Canadian Distributor Replacement Kit (see pg. 5-16)	502K
For Dry-Capacitor & Ballast (see pg. 5-6)	518
For Bracket & Capacitor (see pg. 5-5, 5-7)	700
For Bracket & Dry-Capacitor (see pg. 5-6, 5-7)	718

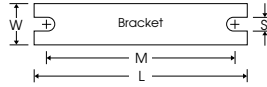

Ref. Dwg.	L	W	M	S
1	4.00"	0.75"	3.35"	0.25"
PC1	5.25"	1.25"	4.60"	0.25"
PC2	7.75"	2.75"	6.10"	0.25"
PC3	7.75"	2.75"	6.10"	0.25"

See p. 5-7 for adjustable mounting brackets and detailed bracket drawings.

REFERENCE DRAWING PC1

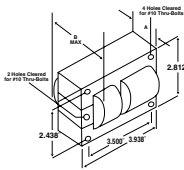

REFERENCE DRAWING PC2

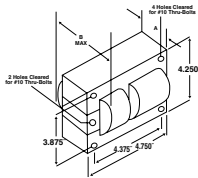

REFERENCE DRAWING PC3

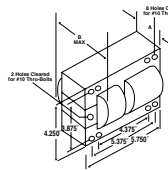

WIRING DIAGRAMS

Wiring Diagram 1

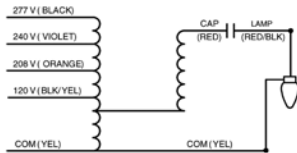

Wiring Diagram 2

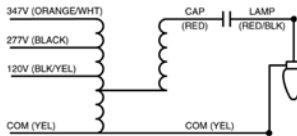

Wiring Diagram 3

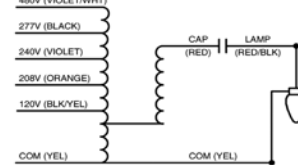

Wiring Diagram 4

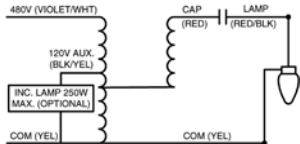

Wiring Diagram 5

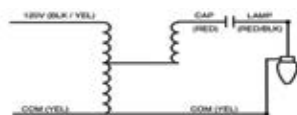

Wiring Diagram 6

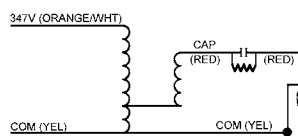

Wiring Diagram 16

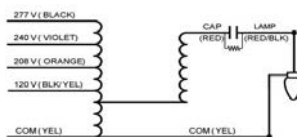

Note: Nominal dimensions provided above
Contact Universal for drawings and/or tolerances

HID
CORE & COIL

**HID CORE & COIL BALLASTS
PULSE START METAL HALIDE**

- 60 Hz
- Minimum starting temperature: -30° C
- Normal and High Power Factor models available

Input Volts	Catalog* Number	Circuit Type	Watts Input	Max Input Current	Nom Open Circuit Voltage	Fuse Rating	Wir Dia	Ref Dwg	Dimensions			Capacitor				Total Weight (lbs.)	Ignitor			
									A	B	µF	Min Volt	Dry Film Dia	Dry Film Ht	Oil Filled Oval		Oil Filled Ht	Catalog Number	Max Distance to lamp (ft)	UL Bench Top Rise
(1) 35/39 WATT M130 METAL HALIDE LAMP																				
120 or 277 or 347	M35TRILC3M	HX-HPF	54	.84	235	1	9	PC1	0.85	2.15	5	300	1.26	2.36	1.31x2.16	2.2	1.7	MH100-3A	5	A
				.40																
				.30																
120 or 208 or 240 or 277	M35MLTLC3M	HX-HPF	50	.82	230	1	10	PC1	0.85	2.0	5	277	1.26	2.83	1.31x2.16	2.2	1.7	MH100-3A	5	A
				.48																
				.42																
				.36																
(1) 50 WATT M110 METAL HALIDE LAMP — Medium Base																				
120 or 277 or 347	M50TRILC3M	HX-HPF	67	1.30	250	2	9	PC1	1.05	2.55	6	300	1.26	2.83	1.31x2.16	2.2	4.25	MH100-3A	10	A
				.61																
				.48																
120 or 208 or 240 or 277	M50MLTLC3M	HX-HPF	65	1.25	255	3	10	PC1	1.05	2.40	6	300	1.26	2.83	1.31x2.16	2.2	3.6	MH100-3A	10	A
				0.70																
				0.60																
				0.55																
(1) 70 WATT M98 / M143 (C98) METAL HALIDE LAMP - Medium Base																				
120 or 277 or 347	M70TRILC3M	HX-HPF	91	1.85	260	2	9	PC1	1.5	2.65	8	280	1.65	2.83	1.31x2.16	2.2	5.0	MH100-3A	10	A
				0.80																
				0.65																
120 or 208 or 240 or 277	M70MLTLC3M	HX-HPF	90	1.70	255	3	10	PC1	1.30	2.65	8	280	1.65	2.83	1.31x2.16	2.2	4.5	MH100-3A	10	A
				1.00																
				0.85																
				0.75																
480	M7048TLC3M	HX-HPF	95	0.45	260	1	8	PC1	1.35	2.80	8	300	1.65	2.83	1.31x2.16	2.2	4.2	MH100-3A	10	E
(1) 70 WATT M85 METAL HALIDE LAMP - Double Ended																				
120 or 208 or 240 or 277	M70MLTLC3D	HX-HPF	90	1.70	255	3	10	PC1	1.30	2.65	8	280	1.65	2.83	1.31x2.16	4.5	4.25	MH70-3B	10	A
				1.00																
				0.85																
				0.75																
(1) 100 WATT M90 / M92 / M140 METAL HALIDE LAMP - Medium Base																				
120 or 277 or 347	M100TRILC3M	HX-HPF	129	2.60	265	3	9	PC1	1.6	2.95	12	280	1.65	2.83	1.31x2.16	3.13	5.5	MH100-3A	10	A
				1.15																
				0.90																
120 or 208 or 240 or 277	M100MLTLC30	HX-HPF	127	2.60	260	5	10	PC1	1.5	2.8	12	280	1.65	2.83	1.31x2.16	n/a	4.5	MH100-3A	10	C C B B
				1.55																
				1.30																
				1.15																
480	M10048TLC3M	HX-HPF	132	0.62	285	2	8	PC1	1.7	3.0	10	300	1.65	2.83	1.31x2.16	2.7	5.5	MH100-3A	10	C
(1) 100 WATT M91 METAL HALIDE LAMP - Double Ended																				
120 or 208 or 240 or 277	M100MLTLC3D	HX-HPF	127	2.60	260	5	10	PC1	1.5	2.8	12	280	1.65	2.83	1.31x2.16	3.13	4.5	MH70-3B	10	C C B B
				1.55																
				1.30																
				1.15																

³ Capacitors are available as an option for high power factor operation.

See page 4-26 for Reference Drawings and Wiring Diagrams.

HID CORE & COIL BALLASTS

PULSE START METAL HALIDE

- 60 Hz
- Minimum Starting Temperature: -40° C
- Feature CWA Design

**PULSE START
MH
150-200 WATT**

Input Volts	Catalog* Number	Circuit Type	Watts Input	Max Input Current	Nom Open Circuit Voltage	Fuse Rating	Wir Dia	Dimensions			Capacitor				Total Weight (lbs.)	Ignitor				
								Ref Dwg	A	B	µF	Min Volt	Dry Film			Oil Filled		Catalog Number	Max Distance to lamp (ft)	UL Bench Top Rise
(1) 150 WATT M102/M142 METAL HALIDE LAMP - Medium Base																				
277	M150277RCEM	RX-NPF RX-HPF	171	0.65	277	4	7	5	2.52	3.80	14	280	1.65	2.83	n/a	n/a	4.0	MH100-1A	3	B
120 or 277 or 347	M150TRILC3M	HX-HPF	185	3.32 1.48 0.65	245	4	9	PC1	2.38	3.65	16	280	1.65	2.83	1.56x2.69	2.7	7.25	MH100-3A	10	D
120 or 208 or 240 or 277	M150MLTLC3M	HX-HPF	185	3.40 1.93 1.70 1.50	260	5 5	10	PC1	2.38	3.7	16	280	1.65	2.83	1.56x2.69	2.7	7.0	MH100-3A	10	A
120 or 208 or 240 or 277	M150MLTAC3M	CWA	188	1.60 1.00 0.80 0.70	210	4 3 3 2	1	PC1	2.5	3.75	16	330	1.65	3.82	n/a	n/a	7.1	MH150-1A	10	C D C C
480	M15048TLC3M	HX-HPF	185	1.00	260	3	8	PC1	2.3	3.6	16	280	1.65	2.83	1.56x2.69	2.7	7.0	MH100-3A	10	F
(1) 150 WATT M81 METAL HALIDE LAMP - Double Ended																				
120 or 208 or 240 or 277	M150MLTLC3D	HX-HPF	185	3.40 1.95 1.70 1.50	260	5 5 5 4	10	PC1	2.38	3.70	16	280	1.65	2.83	1.56x2.69	2.7	7.0	MH70-3B	10	A
(1) 175 WATT M152 / M137 METAL HALIDE PULSE START LAMP (4" FRAME)																				
277	P175277RCEM	RX-NPF RX-HPF	199	1.25 2.00	277	3	7	5	2.5	3.6	12	280	n/a 1.65	n/a 2.83	n/a 1.31x2.16	n/a 3.9	3.9	MH350-1A	10	C
120 or 277 or 347	P175TRIAC3M	CWA	208	2.00 0.90 0.70	310	5 2 2	3	PC1	2.5	3.6	10	400	1.65	2.83	1.31x2.16	3.9	6.75	MH350-1A	10	B
120 or 208 or 240 or 277	P175MLTAC3M	CWA	208	2.09 1.26 1.02 0.96	306	5 3 3 2	1	PC1	2.5	3.6	10	400	1.65	2.83	1.31x2.16	3.9	6.75	MH350-1A	10	A
120 or 208 or 240 or 277	P175MLTAC3L	CWA	198	1.95 1.10 1.00 0.80	285	5 3 3 2	1	PC1	3.10	4.20	11	370	1.65	2.83	n/a	n/a	8.5	MH350-1A	2	A
120 or 208 or 240 or 277 or 480	P175ML5AC3M	CWA	210	1.80 1.05 0.90 0.80	295	5 3 3 2	4	PC1	2.65	4.0	10	400	1.65	2.83	1.91x2.91	2.7	8.0	MH350-1A	10	B
480	P17548TAC3L	CWA	198	0.45 0.50	285	2	2	PC1	3.10	4.20	11	360	1.65	2.83	n/a	n/a	8.5	MH350-1A	2	A
(1) 175 WATT M152/M137 METAL HALIDE PULSE START LAMP (5" FRAME)																				
120 or 208 or 240 or 277	P175MLTAC4L	CWA	198	1.70 0.95 0.85 0.75	270	5 3 3 2	1	PC2	1.77	3.3	12.5	330	1.65	2.83	n/a	n/a	9.45	MH350-1A	10	A
480	P17548TAC4L	CWA	198	0.40	275	2	4	PC2	1.80	3.5	12.5	330	1.65	2.83	n/a	n/a	9.6	MH350-1A	10	A

See page 4-26 for Reference Drawings and Wiring Diagrams.

**HID
CORE & COIL**

**HID CORE & COIL BALLASTS
PULSE START METAL HALIDE**

- 60 Hz
- Minimum Starting Temperature: -40° C
- CWA and High Power Factor Models Available

Input Volts	Catalog* Number	Circuit Type	Watts Input	Max Input Current	Nom Open Circuit Voltage	Fuse Rating	Wir Dia	Dimensions			Capacitor				Total Weight (lbs.)	Ignitor		UL Bench Top Rise		
								Ref Dwg	A	B	µF	Min Volt	Dry Film			Oil Filled			Catalog Number	Max Distance to lamp (ft)
(1) 200 WATT M136 METAL HALIDE PULSE START LAMP																				
277	P200277RCEM	RX-HPF	218	1.35	277	4	7	5	1.06	2.82	13	280	1.65	3.83	n/a	n/a	4.7	MH350-1A	10	A
120 or				2.70		6														
277 or	P200TRIAC3M	CWA	240	1.04	310	3	3	PC1	2.75	3.95	11	400	1.65	2.83	2.7	3.6	8.0	MH350-1A	10	C
347				0.87		3														
120 or				2.10		7														
208 or				1.22		5														
240 or	P200MLTAC3L	CWA	227	1.05	245	4	1	PC1	2.90	4.25	15	330	1.85	3.82	n/a	n/a	9.0	MH100-5A	10	A
277				0.95		4														
(1) 200 WATT M136 METAL HALIDE PULSE START LAMP																				
120 or				2.66		6														
208 or				1.52		4														
240 or	P200ML5AC3M	CWA	233	1.31	303	3	2	PC1	2.75	4.30	11	400	1.65	2.83	n/a	n/a	8.0	MH350-1A	10	C
277 or				1.12		3														
480				0.68		2														
480	P20048TAC3L	CWA	227	0.50	245	2	4	PC1	2.9	4.25	15	330	1.85	3.82	n/a	n/a	9.0	MH100-5A	10	A
(1) 250 WATT M153 METAL HALIDE PULSE START LAMP																				
277	P250277RCEM	RX-NPF RX-HPF	278	2.00 1.85	277	5 5	7	5	1.06	2.82	17.5	280	n/a 1.6	n/a 3.82	n/a 1.56x2.69	n/a 3.1	4.8	MH350-1A	10	A
120 or				2.35		8														
277 or	P250TRIAC4M	CWA	300	1.15	292	3	3	PC2	1.36	3.36	14	400	1.6	3.782	2.3	4.0	9.0	MH350-1A	10	A
347				.098		3														
120 or				2.40		8														
208 or	P250MLTAC4L	CWA	283	1.40	270	5	1	PC2	2.05	3.90	17	330	1.65	3.82	n/a	n/a	11.0	MH350-1A	15	A
240 or				1.20		5														
277				1.05		3														
120 or				2.50		8														
208 or				1.40		5														
240 or	P250ML5AC4L	CWA	283	1.25	270	5	2	PC2	1.85	3.75	17	330	1.65	3.82	n/a	n/a	10.5	MH350-1A	10	A
277 or				1.05		3														
480				0.60		2														
480	P25048TAC4L	CWA	283	0.60	275	2	4	PC2	1.9	3.6	17	360	1.65	3.82	n/a	n/a	10.0	MH350-1A	10	A
(1) 320 WATT M132 / M154 METAL HALIDE PULSE START LAMP																				
277	P320277RCEM	RX-NPF RX-HPF	348	3.70 2.34	277	10 6	7	5	1.5	3.28	22.5	280	n/a 1.865	n/a 3.115	n/a n/a	n/a n/a	6.8	MH350-1A	10	A
120 or				3.85		8														
277 or	P320TRIAC4M	CWA	370	1.70	280	4	3	PC2	2.0	3.73	20.5	360	1.85	3.82	1.91x2.91	3.1	11.0	MH350-1A	10	C
347				1.30		3														
120 or				3.10		9														B
208 or	P320MLTAC40	CWA	364	1.80	275	5	1	PC2	2.0	3.9	21.0	360	1.85	3.82	1.91x2.91	3.1	11.0	MH350-1A	10	A
240 or				1.55		5														B
277				1.35		4														A
120 or				4.00		10														D
208 or				2.40		7														C
240 or	P320ML5AC4M	CWA	370	2.10	280	5	2	PC2	2.0	3.86	20.5	360	1.8	3.82	1.91x2.91	3.6	11.3	MH350-1A	10	D
277 or				1.85		5														D
480				1.00		3														C

**See page 4-26 for Reference
Drawings and Wiring Diagrams.**

HID CORE & COIL BALLASTS

PULSE START METAL HALIDE

- 60 Hz
- Minimum Starting Temperature: -40° C
- Feature CWA Design

**PULSE START
MH
320-350 WATT**

Input Volts	Catalog* Number	Circuit Type	Watts Input	Max Input Current	Nom Open Circuit Voltage	Fuse Rating	Wir Dia	Dimensions			Capacitor				Total Weight (lbs.)	Ignitor					
								Ref Dwg	A	B	µF	Min Volt	Dry Film			Oil Filled		Catalog Number	Max Distance to lamp (ft)	UL Bench Top Rise	
													Dia	Ht		Oval	Ht				
(1) 320 WATT M132 / M154 METAL HALIDE PULSE START LAMP																					
120 or 208 or 240 or 277 or 480	P320ML5AC4L	CWA	363	3.10	275	5	2	PC2	1.88	3.8	21	360	1.85	3.82	2.91	3.13	12.0	MH350-1A	10	A	
480				0.80																	3
480				0.80																	3
480				0.80																	3
480				0.80																	3
480	P32048TAC4L	CWA	364	0.80	280	3	4	PC2	2.0	3.9	21	360	1.85	3.82	2.91	3.13	11.0	MH350-1A	10	A	
(1) 350 WATT M131 METAL HALIDE PULSE START LAMP																					
277	P350277RCEM	RX-NPF	377	3.80	277	10	7	5	1.5	3.28	22.5	280	—	—	—	—	6.8	MH350-1	10	A	
		RX-HPF		2.35									6	1.65	3.82	1.56x2.69					3.9
120 or 277 or 347	P350TRIAC4M	CWA	405	4.85	280	5	3	PC2	2.0	4.0	21	360	1.85	3.82	2.9	3.1	11.5	MH350-1A	10	C	
				1.30																	3
				1.30																	3
120 or 208 or 240 or 277	P350MLTAC4M	CWA	400	3.40	275	6	1	PC2	2.0	3.9	22	360	n/a	n/a	2.7	3.9	11.0	MH350-1A	10	C	
				2.00									5								
				1.70									5								
				1.45									4								
120 or 208 or 240 or 277	P350MLTAC4O	CWA	397	3.25	270	6	1	PC2	1.92	3.95	22.5	345	1.85	3.82	n/a	n/a	10.0	MH350-1A	10	B	
				1.80											5						
				1.60											5						
				1.40											4						
120 or 208 or 240 or 277 or 480	P350ML5AC4O	CWA	397	3.35	280	5	4	PC2	2.2	4.25	22.5	345	1.85	3.82	n/a	n/a	12	MH350-1A	10	B	
				1.85											6						
				1.65											5						
				1.40											4						
				0.80											3						
120 or 208 or 240 or 277 or 480	P350ML5AC4L	CWA	397	3.35	275	9	4	PC2	1.88	3.8	22	360	1.85	3.82	2.69	3.9	12.0	MH350-1A	10	B	
				1.90																	7
				1.65																	5
				0.85																	3
480	P35048TAC4O	CWA	398	0.85	280	3	4	PC2	2.00	3.95	22.5	345	1.85	3.82	n/a	n/a	11.0	MH350-1A	10	D	
480	P35048TAC4L	CWA	397	0.85	280	3	4	PC2	2.00	3.9	22	360	1.85	3.82	2.69	3.9	11.0	MH350-1A	10	C	

See page 4-26 for Reference Drawings and Wiring Diagrams.

HID
CORE & COIL

See page 5-29 for Reference Drawings and Wiring Diagrams.

**HID CORE & COIL BALLASTS
PULSE START METAL HALIDE**

- 60 Hz
- Minimum Starting Temperature: -40° C
- CWA and High Power Factor Models Available

Input Volts	Catalog* Number	Circuit Type	Watts Input	Max Input Current	Nom Open Circuit Voltage	Fuse Rating	Wir Dia	Dimensions			Capacitor				Total Weight (lbs.)	Ignitor		UL Bench Top Rise		
								Ref Dwg	A	B	μF	Min Volt	Dry Film			Oil Filled			Catalog Number	Max Distance to lamp (ft)
(1) 400 WATT M155 / M135 / M128 / M172 METAL HALIDE PULSE START LAMP																				
120 or 277 or 347	P400TRIAC4M	CWA	454	4.05	285	10	3	PC2	2.0	3.9	24	400	1.85	3.82	1.91x2.91	3.1	12	MH350-1A	10	D
				1.75		5														
120 or 208 or 240 or 277	P400MLTAC4L	CWA	454	3.90	280	10	1	PC2	2.30	4.20	26	330	1.85	3.82	n/a	n/a	11	MH350-1A	10	B
				2.25		7														B
				1.95		5														B
				1.70		5														C
120 or 208 or 240 or 277 or 480	P400ML5AC4M	CWA	457	3.90	285	10	26	PC2	2.0	3.9	24	400	1.85	3.82	1.91x2.91	3.1	12.5	MH350-1A	10	D
				2.25		7														
				1.90		5														C
				1.70		5														C
				0.95		3														D
120 or 208 or 240 or 277 or 480	P400ML5AC4L	CWA	454	3.90	280	10	2	PC2	2.35	4.25	26	330	1.85	3.82	1.91x2.91	3.1	12	MH350-1A	10	C
				2.25		7														D
				1.90		5														C
				1.65		5														C
				0.95		3														D
480	P40048TAC4L	CWA	454	1.00	285	3	4	PC2	2.35	4.25	26	330	1.85	3.82	n/a	n/a	12.5	MH350-1A	10	D
480	P40048TAC4M	CWA	457	1.00	285	3	4	PC2	2.0	3.9	24	400	1.85	3.82	1.91x2.91	3.1	12	MH350-1A	10	D

**See page 4-26 for Reference
Drawings and Wiring Diagrams.**

HID CORE & COIL BALLASTS

PULSE START METAL HALIDE

- 60 Hz
- Minimum Starting Temperature: -40° C
- CWA and High Power Factor Models Available

**PULSE START
MH
450-1000 WATT**

Input Volts	Catalog* Number	Circuit Type	Watts Input	Max Input Current	Nom Open Circuit Voltage	Fuse Rating	Wir Dia	Dimensions			Capacitor				Total Weight (lbs.)	Ignitor		UL Bench Top Rise		
								Ref Dwg	A	B	µF	Min Volt	Dry Film			Oil Filled			Catalog Number	Max Distance to lamp (ft)
(1) 450 WATT M144 METAL HALIDE PULSE START LAMP																				
120 or	P450MLTAC4L	CWA	508	4.35	280	10	1	PC2	2.25	4.0	26.5	400	1.85	4.76	1.91x2.91	3.9	13.0	MH350-1A	10	B
208 or				2.55		8														C
240 or				2.15		7														C
277				1.90		5														C
120 or	P450ML5AC4L	CWA	508	4.10	280	12	2	PC2	2.65	4.55	26.5	360	1.85	4.76	1.91x2.91	3.9	15.5	MH350-1	10	C
208 or				2.35		8														B
240 or				2.05		7														C
277 or				1.85		5														C
480				1.05		4														B
480	P45048TAC4L	CWA	511	1.05	277	3	4	PC2	2.40	4.25	26.5	360	1.85	4.76	1.91x2.91	3.9	14.5	MH350-1A	10	D
(1) 750 WATT M149 METAL HALIDE PULSE START LAMP																				
120 or	P750TRIAC5M	CWA	820	7.05	340	15	3	PC3	2.8	4.6	28	400	n/a	n/a	1.91x2.91	3.88	18.0	P750-1B	10	B
277 or				3.05		8														C
347				2.45		8														C
120 or	P750MLTAC5M	CWA	825	7.10	340	18	1	PC3	2.8	4.8	28	400	n/a	n/a	1.91x2.91	3.88	18.0	P750-1B	10	D
208 or				4.10		10														A
240 or				3.55		10														B
277				3.10		8														B
120 or	P750ML5AC5M	CWA	820	6.95	340	18	2	PC3	2.8	4.9	28	400	n/a	n/a	1.91x2.91	3.88	19.0	P750-1B	15	C
208 or				4.00		10														C
240 or				3.50		10														D
277 or				3.00		8														D
480				1.75		5														C
480	P75048TAC5M	CWA	822	1.80	335	5	4	PC3	2.8	4.75	28	400	n/a	n/a	1.91x2.91	3.88	18.0	P750-1B	10	D
(1) 875 WATT M166 METAL HALIDE PULSE START LAMP																				
120 or	P875MLTAC5M	CWA	945	7.90	395	20	1	PC3	2.8	4.8	24	480	n/a	n/a	1.91x2.91	3.9	17.5	HPS1000-4B	10	D
208 or				4.55		15														C
240 or				3.95		10														A
277				3.45		10														C
(1) 1000 WATT M141 METAL HALIDE PULSE START LAMP																				
120 or	P1000MLTAC5M	CWA	1080	9.00	420	20	1	PC3	2.9	5.05	24	480	n/a	n/a	1.91x2.91	3.9	22.0	HPS1000-4B	20	D
208 or				5.20		15														
240 or				4.50		10														
277				3.90		10														
120 or	P1000ML5AC5M	CWA	1080	8.95	420	20	2	PC3	2.9	5.05	24	480	n/a	n/a	1.91x2.91	3.9	22.0	HPS1000-4B	20	G
208 or				5.15		15														B
240 or				4.45		10														C
277 or				3.85		10														C
480				2.25		10														C
480	P100048TAC5M	CWA	1080	2.30	410	6	4	PC3	2.85	4.75	24	480	n/a	n/a	1.91x2.91	3.9	18.0	HPS1000-4B	15	D2

See page 4-26 for Reference Drawings and Wiring Diagrams.

HID
CORE & COIL

HID CORE & COIL BALLASTS PULSE START METAL HALIDE

DESCRIPTION	SUFFIX *
For Ballast Only	000
For Bracket Only (see pg. 5-7)	200
For Capacitor Only (see pg. 5-5, 5-6)	500
For Distributor Replacement Kit (see pg. 5-13 thru 5-15)	500K
For Canadian Distributor Replacement Kit (see pg. 5-16)	502K
For Dry-Capacitor & Ballast (see pg. 5-6)	518
For Bracket & Capacitor (see pg. 5-5, 5-7)	700
For Bracket & Dry-Capacitor (see pg. 5-6, 5-7)	718

REFERENCE DRAWING PC1

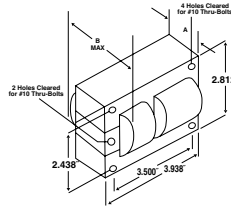

REFERENCE DRAWING PC2

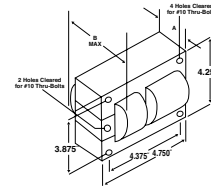

REFERENCE DRAWING PC3

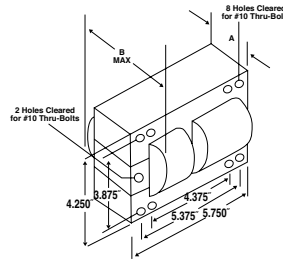

REFERENCE DRAWING 5

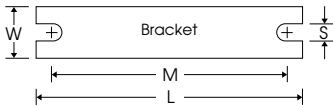
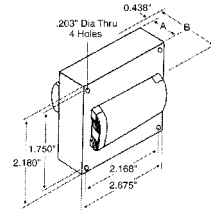

Ref. Dwg.	L	W	M	S
PC1	5.25"	1.25"	4.60"	0.25"
PC2	7.75"	1.25"	5.75"	0.25"
PC3	7.75"	2.75"	6.10"	0.25"
RX1	4.00"	0.75"	3.35"	0.25"

See p. 5-7 for adjustable mounting brackets and detailed bracket drawings.

WIRING DIAGRAMS

Wiring Diagram 1

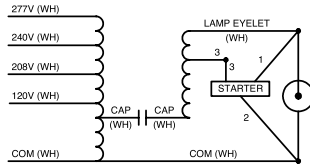

Wiring Diagram 2

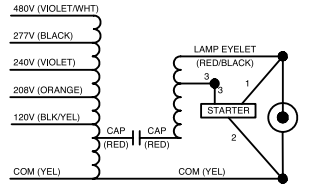

Wiring Diagram 3

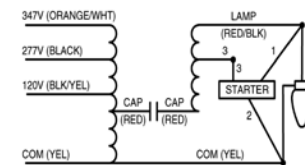

Wiring Diagram 4

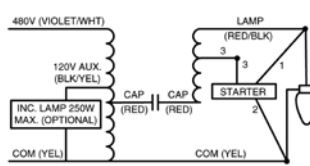

Wiring Diagram 7

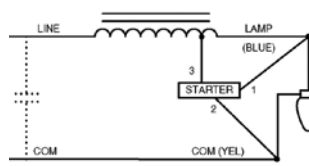

Wiring Diagram 8

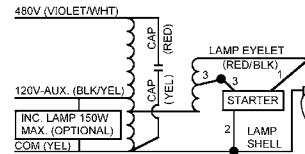

Wiring Diagram 10

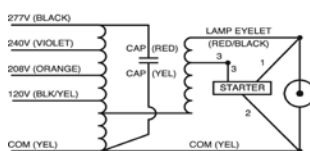

Wiring Diagram 9

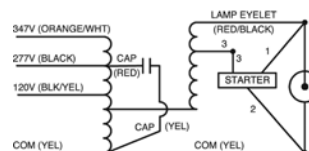

Note: Nominal dimensions provided above
Contact Universal for drawings and/or tolerances

HID CORE & COIL BALLASTS

HIGH PRESSURE SODIUM

- 60 Hz
- Minimum Starting Temperature: -40° C
- Normal and High Power Factor Models

HPS
35-100
WATT

Input Volts	Catalog* Number	Circuit Type	Watts Input	Max Input Current	Nom Open Circuit Voltage	Fuse Rating	Wir Dia	Ref Dwg	Dimensions		Min Volt	Capacitor				Total Weight (lbs.)	Ignitor			
									A	B		Dry Film		Oil Filled			Catalog Number	Max Distance to lamp (ft)	UL Bench Top Rise	
(1) 35 WATT S76 HIGH PRESSURE SODIUM LAMP																				
120 ¹	1233-251W [•]	R-HPF ₃	43	0.65 1.15	120	2 3	11	1	0.63	2.0	14	120	1.87	2.25	1.56x2.69	2.7	1.5	HPS150-3A Permanently Attached	3	A
120	S35120RCEM	RX-NPF RX-HPF	44	0.85 0.65	120	2 3	7	5	0.55	1.75	14	220	1.87	2.25	1.9	2.3	1.2	HPS150-3A	10	A
(1) 50 WATT S68 HIGH PRESSURE SODIUM LAMP																				
120 ¹	1233-35W [•]	R-HPF ₃	60	0.90 1.50	120	3 5	11	1	0.94	2.40	20	120	1.65	2.83	1.56x2.69	3.1	2.0	HPS150-3A Permanently Attached	3	A
120	S50120RCEM	RX-NPF RX-HPF	60	0.90 1.10	120	3 4	7	5	0.83	1.95	20	240	1.87	2.25	1.9	2.3	1.5	HPS150-3A	3	A
120 or 208 or 240 or 277	S50MLTLC3M	HX-HPF	66	1.24 0.60 0.52 0.45	130	5 3 3 2	10	PC1	1.3	2.7	5	300	1.2	2.2	2.2	2.2	4.1	HPS150-3A	5	A
(1) 70 WATT S62 HIGH PRESSURE SODIUM LAMP																				
120	1233-142W [•]	R-HPF	83	1.30 2.10	120	8 8	11	1	1.32	2.7	2.8	120	1.65	4.75	n/a	n/a	2.5	HPS150-3A Permanently Attached	3	A
120	S70120RCEM	RX-NPF RX-HPF	82	1.30 2.10	120	4 6	7	5	1.10	2.25	28	120	1.87	2.25	1.3	2.7	2.0	HPS150-3A	3	A
120 or 277 or 347	S70TRILC3M	HX-HPF	94	1.50 0.65 0.50	120	4 2 2	9	PC1	1.38	2.7	7	280	1.65	2.83	1.31x2.16	2.2	4.4	HPS150-3A	10	B A A
120 or 208 or 240 or 277	S70MLTLC3M	HX-HPF	98	1.50 0.88 0.75 0.65	120	5 3 3 2	10	PC1	1.38	2.74	7	280	1.65	2.83	1.31x2.16	2.2	4.1	HPS150-3A	10	B
480	S7048TLC3M	HX-HPF	94	0.34	120	2	8	PC1	1.85	3.0	7	280	1.65	3.00	1.31x2.16	2.2	6.0	HPS150-3A	10	A
(1) 100 WATT S54 HIGH PRESSURE SODIUM LAMP																				
120 ¹	1233-10W [•]	R-HPF ₃	114	1.80 2.90	120	5 8	11	1	1.5	2.9	40	120	1.87	2.78	1.87	2.9	2.8	HPS150-3A Permanently Attached	3	A
120	S100120RCEM	RX-NPF RX-HPF	115	2.90 1.80	120	8 5	7	5	1.50	2.75	40	120	1.87	2.78	1.8	2.7	2.0	HPS150-3A	10	A
120 or 277 or 347	S100TRILC3M	HX-HPF	130	2.20 0.95 0.69	120	8 3 2	9	PC1	2.0	3.5	10	330	1.2	2.7	1.31x2.16	2.7	5.9	HPS150-3A	10	B
120 or 208 or 240 or 277	S100MLTLC3M	HX-HPF	122	2.20 1.30 1.10 0.95	120	7 5 3 3	10	PC1	2.0	3.36	10	280	1.26	2.83	1.31x2.16	2.7	6.0	HPS150-3A	10	B
480	S10048TLC3M	HX-HPF	132	0.57	120	2	8	PC1	2.0	3.3	10	280	1.26	2.83	1.31x2.16	2.2	6.0	HPS150-3A	5	E

¹ Also can be used on a 277 volt line in conjunction with the step down transformers
³ Capacitors are available as an option for High Power Factor operation
[•] Ballast has built-in starter.

See pages 4-31 and 4-32 for Reference Drawings and Wiring Diagrams.

HID
CORE & COIL

HID CORE & COIL BALLASTS
HIGH PRESSURE SODIUM

- 60 Hz
- Minimum Starting Temperature: -40° C
- CWA, Normal and High Power Factor Models

Input Volts	Catalog* Number	Circuit Type	Watts Input	Max Input Current	Nom Open Circuit Voltage	Fuse Rating	Wir Dia	Ref Dwg	Dimensions		Capacitor				Total Weight (lbs.)	Ignitor		UL Bench Top Rise		
									A	B	µF	Min Volt	Dry Film			Oil Filled			Catalog Number	Max Distance to lamp (ft)
(1) 150 WATT S55 HIGH PRESSURE SODIUM LAMP																				
120 ¹	I233-154W*	R-HPF ₃	170	2.35 4.40	120	6 12	11	1	2.0	3.4	52	240	1.85	3.82	2.12	2.9	3.5	HPS150-3A Permanently Attached	3	A
120	S150120RCEM	RX-NPF RX-HPF	170	2.35 4.40	120	12 6	7	5	2.0	3.05	50	120	1.87	n/a	2.0	2.9	3.25	HPS150-3A	3	A
120 or 277	S15027TLC3M	HX-HPF	188	3.10 1.30	120	10 5	12	PC1	2.5	3.85	14	280	1.65	2.83	1.56x2.69	2.7	7.0	HPS150-3A	10	B A
120 or 277 or 347	S150TRILC3M	HX-HPF	188	3.00 1.35 1.00	120	10 5 4	9	PC1	2.38	3.68	14	300	1.6	2.8	1.56x2.69	2.7	7.0	HPS150-3A	10	B C B
120 or 208 or 240 or 277	S150MLTLC3O	HX-HPF	188	3.00 1.65 1.50 1.30	120	10 5 5 4	10	PC1	2.5	3.85	14	280	1.6	2.8	2.7	2.7	7.0	HPS150-3A	10	E D E D
480	S15048TLC3M	HX-HPF	189	0.72	120	2	8	PC1	3.0	4.5	14	280	1.6	2.83	1.56x2.69	2.7	8.75	HPS150-3A	10	D
(1) 200 WATT S66 HIGH PRESSURE SODIUM LAMP																				
120	S200TRIAC4M	CWA	240	2.00	184	7	3	PC2	1.45	3.25	28	280	1.65	4.76	1.91x2.91	3.1	8.65	HPS400-3A	10	C
277 347				0.86 0.68		3 3														
120 or 208 or 240 or 277	S200MLTAC4M	CWA	240	2.10 1.20 1.00 0.88	175	7 4 4 4	1	PC2	1.2	3.0	28	280	1.65	4.76	1.91x2.91	3.1	8.5	HPS400-3A	10	B
480	S20048TAC4M	CWA	240	0.56	172	2	4	PC2	1.2	3.0	28	280	1.65	4.76	1.91x2.91	3.1	8.5	HPS400-3A	10	C
(1) 250 WATT S50 HIGH PRESSURE SODIUM LAMP																				
120	S250120AC4M	CWA	295	2.50	185	8	13	PC2	1.8	3.65	35	330	n/a	n/a	1.8	3.1	10.3	HPS400-3A	10	A
120 or 277 or 347	S250TRIAC4M	CWA	295	2.40 1.05 0.85	185	7 3 3	3	PC2	1.8	3.55	35	240	1.65	3.82	1.91x2.91	3.1	10	HPS400-3A	10	B B C
120 or 208 or 240 or 277	S250MLTAC4M	CWA	295	2.50 1.45 1.25 1.10	190	7 4 4 3	1	PC2	1.8	3.55	35	240	1.65	3.82	1.91x2.91	3.1	10	HPS400-3A	10	B
120 or 208 or 240 or 277 or 480	S250ML5AC4O	CWA	300	2.50 1.55 1.25 1.05 0.65	188	8 4 4 3 2	2	PC2	1.95	3.70	35	240	1.65	3.82	1.91x2.91	3.1	11	HPS400-3A	10	C C B B B
480	S25048TAC4M	CWA	298	0.65	190	2	4	PC2	1.85	3.65	35	240	1.65	3.82	1.91x2.91	3.1	10	HPS400-3A	5	A

* Ballast has built-in starter.

* Also can be used on a 277 volt line in conjunction with the step-down transformers described on page 5-53.

³ Capacitors are available as an option for high power factor operation.

See pages 4-31 and 4-32 for Reference Drawings and Wiring Diagrams.

HID CORE & COIL BALLASTS

HIGH PRESSURE SODIUM- FEATURING MULTI-5™

- 60 Hz
- Minimum Starting Temperature: -40° C
- CWA, Normal and High Power Factors Models Available

**HPS
400-430
WATT**

Input Volts	Catalog* Number	Circuit Type	Watts Input	Max Input Current	Nom Open Circuit Voltage	Fuse Rating	Wir Dia	Ref Dwg	Dimensions		Capacitor				Total Weight (lbs.)	Ignitor		UL Bench Top Rise																				
									A	B	µF	Min Volt	Dry Film			Oil Filled			Catalog Number	Max Distance to lamp (ft)																		
													Dia	Ht		Oval	Ht																					
(1) 400 WATT S51 HIGH PRESSURE SODIUM LAMP - 4 3/8" Frame																																						
120 or 277 or 347	S400TRIAC4M	CWA	465	3.95	190	10	3	PC2	2.32	4.1	55	240	1.77	3.74	1.91x2.91	3.5	14.0	HPS400-3A	10	D																		
				1.70		5																																
				1.35		4																																
120 or 208 or 240 or 277	S400MLTAC4M	CWA	463	3.80	190	10	1	PC2	2.32	4.1	55	240	1.77	3.74	1.91x2.91	3.5	14.0	HPS400-3A	10	D																		
				2.20		6																																
				1.90		5																																
				1.90		5																																
120 or 208 or 240 or 277 or 480	S400ML5AC4M	CWA	465	3.95	190	10	2	PC2	2.44	4.3	55	240	1.77	3.74	1.91x2.91	3.5	14.0	HPS400-3A	10	D																		
				2.30		6																																
				2.00		5																																
				1.70		5																																
				1.00		3																																
480	S40048TAC4M	CWA	464	1.00	190	3	4	PC2	2.32	4.1	55	240	1.77	3.74	1.91x2.91	3.5	14.0	HPS400-3A	10	D																		
(1) 400 WATT S51 HIGH PRESSURE SODIUM LAMP - 5 3/8" Frame																																						
120 or 277 or 347	S400TRIAC5M	CWA	467	3.90	200	10	3	PC2	2.2	4.1	48	280	2.05	4.76	1.91x2.91	3.9	16.0	HPS400-3A	10	E																		
				1.70		5																																
				1.35		4																																
120 or 208 or 240 or 277	S400MLTAC5M	CWA	465	3.95	200	10	1	PC3	2.25	4.1	48	280	2.05	4.76	1.91x2.91	3.9	16.0	HPS400-3A	10	D																		
				2.30		6																																
				2.00		5																																
				1.70		5																																
120 or 208 or 240 or 277 or 480	S400ML5AC5M	CWA	468	4.00	200	10	2	PC3	2.5	4.5	48	300	2.05	4.76	1.91x2.91	3.9	17.5	HPS400-3A	10	D																		
				2.30		6																																
				2.00		5																																
				1.75		5																																
				1.00		3																																
480	S40048TAC5M	CWA	467	1.00	200	3	4	PC3	2.25	4.1	48	280	2.05	4.76	1.91x2.91	3.9	16.0	HPS400-3A	10	D																		
(1) 430 WATT SON AGRO HIGH PRESSURE SODIUM LAMP																																						
120 or 208 or 240 or 277	S430MLTAC4M	CWA	490	4.50	205	10	1	PC2	2.25	4.25	48	330	2.0	4.7	1.91x2.91	3.9	11.0	HPS400-3A	10	D																		
				2.50		8																																
				2.10		7																																
				1.80		5																																

³ Capacitors are available as an option for high power factor operation.

See pages 4-31 and 4-32 for Reference Drawings and Wiring Diagrams.

HID CORE & COIL BALLASTS
HIGH PRESSURE SODIUM

- 60 Hz
- Minimum Starting Temperature: -40° C
- CWA models available

Input Volts	Catalog* Number	Circuit Type	Watts Input	Max Input Current	Nom Open Circuit Voltage	Fuse Rating	Wir Dia	Dimensions			Capacitor				Total Weight (lbs.)	Ignitor				
								Ref Dwg	A	B	µF	Min Volt	Dry Film			Oil Filled		Catalog Number	Max Distance to lamp (ft)	UL Bench Top Rise
(1) 600 WATT S106 HIGH PRESSURE SODIUM LAMP																				
120 or 208 or 240 or 277	S600MLTAC5M	CWA	640	5.10	240	20	1	PC3	3.0	5.0	55	300	1.8	4.7	1.91x2.91	3.9	21.0	HPS600-1B	10	A
				3.10		15														
				2.70		10														
				2.35		10														
(1) 1000 WATT S52 HIGH PRESSURE SODIUM LAMP																				
120 or 240	S100024TAC5M	CWA	1100	9.50	440	24	14	PC3	3.8	5.7	26	525	n/a	n/a	1.91x2.91	4.25	26.0	HPS1000-4B	15	C
				4.80		12														
120 or 277 or 347	S1000TRIAC5M	CWA	1100	9.60	440	20	3	PC3	3.8	5.75	26	525	n/a	n/a	1.91x2.91	4.25	27.0	HPS1000-4B	15	D
				4.30		10														
				3.40		10														
120 or 208 or 240 or 277	S1000MLTAC5M	CWA	1100	9.50	440	24	1	PC3	3.8	5.7	26	525	n/a	n/a	1.91x2.91	4.25	26.0	HPS1000-4B	15	C
				5.50		15														
				4.80		12														
				4.20		10														
120 or 208 or 240 or 277 or 480	S1000ML5AC5M	CWA	1048	9.45	440	20	2	PC3	3.75	5.65	26	525	n/a	n/a	1.91x2.91	4.25	26.0	HPS1000-4B	15	D
				5.45		15														
				4.75		10														
				4.10		10														
				2.35		8														
480	S1000480AC5M	CWA	1100	2.45	440	8	4	PC3	3.8	5.7	26	525	n/a	n/a	1.91x2.91	4.25	25.0	HPS1000-4B	15	D
480	S100048TAC5M	CWA	1100	2.45	440	8	4	PC3	3.8	5.7	26	525	n/a	n/a	1.91x2.91	4.25	25.0	HPS1000-4B	15	D

See pages 4-31 and 4-32 for Reference Drawings and Wiring Diagrams.

HID CORE & COIL BALLASTS

HIGH PRESSURE SODIUM

HPS

DESCRIPTION	SUFFIX *
For Ballast Only	000
For Bracket Only (see pg. 5-7)	200
For Capacitor Only (see pg. 5-5, 5-6)	500
For Distributor Replacement Kit (see pg. 5-13 thru 5-15)	500K
For Canadian Distributor Replacement Kit (see pg. 5-16)	502K
For Dry-Capacitor & Ballast (see pg. 5-6)	518
For Bracket & Capacitor (see pg. 5-5, 5-7)	700
For Bracket & Dry-Capacitor (see pg. 5-6, 5-7)	718

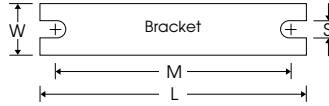

Ref. Dwg.	L	W	M	S
1, 1a, 5	4.00"	0.75"	3.35"	0.25"
PC1, 4	5.25"	1.25"	4.60"	0.25"
PC2, PC3	7.75"	1.25"	5.75"	0.25"

See p. 5-7 for adjustable mounting brackets and detailed bracket drawings.

REFERENCE DRAWING 1

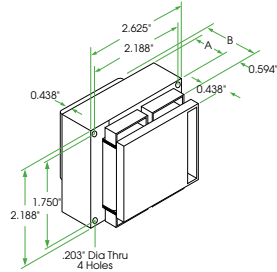

REFERENCE DRAWING 5

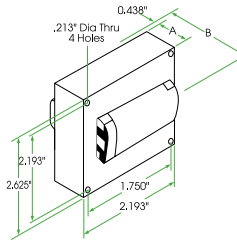

REFERENCE DRAWING PC1

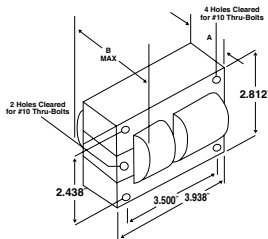

REFERENCE DRAWING PC2

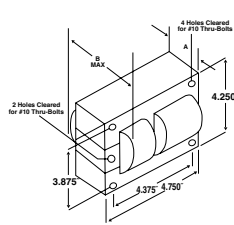

REFERENCE DRAWING PC3

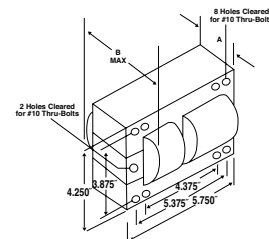

Note: Nominal dimensions provided above
Contact Universal for drawings and/or tolerances

HID
CORE & COIL

WIRING DIAGRAMS

Wiring Diagram 1

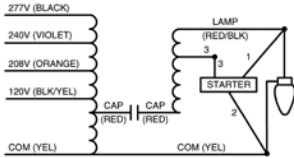

Wiring Diagram 7

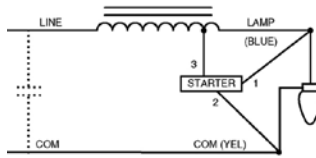

Wiring Diagram 11

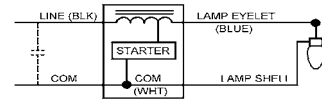

Wiring Diagram 2

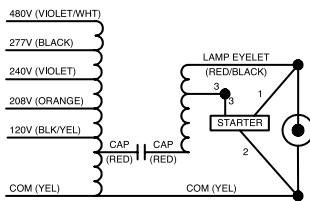

Wiring Diagram 8

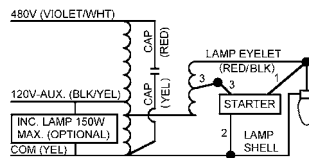

Wiring Diagram 12

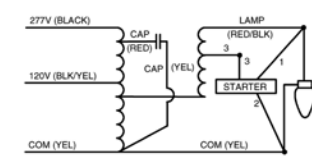

Wiring Diagram 3

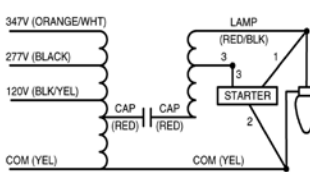

Wiring Diagram 9

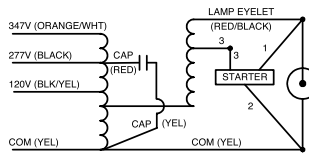

Wiring Diagram 13

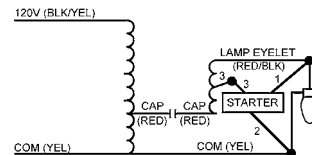

Wiring Diagram 4

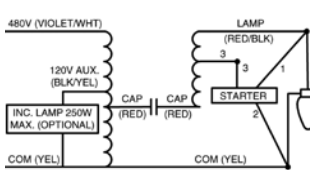

Wiring Diagram 10

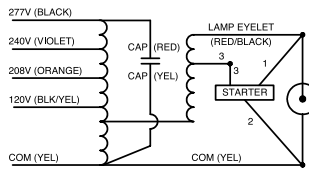

Wiring Diagram 14

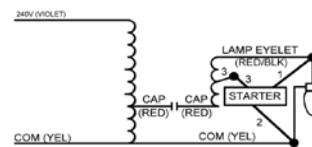

HID CORE & COIL BALLASTS

50 HERTZ

- 50 Hz
- Minimum Starting Temperature: -40° C
- CWA, Normal and High Power factor models available

MH & HPS
50 HZ

Input Volts	Catalog* Number	Circuit Type	Input Watts	Max Input Curr.	Nom Open Circuit Volt.	Fuse Rating	Wir Dia	Dimensions			Capacitor				Total Wt. (lbs.)	Ignitor		UL Bench Top Rise		
								Ref Dwg	A	B	µF	Min Volt	Dry Film			Oil Filled			Catalog Number	Max Dist. lamp
													Dia	Ht		Oval	Ht			
(1) 175 WATT M57 METAL HALIDE LAMP																				
230	M175230AC3M	CWA	205	1.00	310	3	15	PC1	2.25	3.55	12	400	6.5	3.82	1.5	3.13	6.7	n/a	n/a	C
(1) 250 WATT M58 METAL HALIDE LAMP																				
230	M250230AC3M	CWA	282	1.40	285	4	15	PC1	3.0	4.3	18	400	n/a	n/a	2.01x3.01	3.1	9	n/a	n/a	D
(1) 400 WATT M59 METAL HALIDE LAMP																				
230	M400230AC4M	CWA	448	2.20	300	6	15	PC2	2.13	3.75	28	425	n/a	n/a	1.91x2.91	3.9	13	n/a	n/a	D
(1) 1000 WATT M47 METAL HALIDE LAMP																				
230	M1000230AC5M	CWA	1080	4.70	420	13	18	PC3	3.4	5.3	30	440	n/a	n/a	2.01x3.01	3.9	21	n/a	n/a	C
220	M1000230DAC5M	CWA	1080	8.50	405	22	18	PC3	3.45	4.90	30	440	n/a	n/a	1.91x2.91	3.87	24	n/a	n/a	A
230				4.80		13														B
(1) 1500 WATT M48 METAL HALIDE LAMP																				
220	M1500230AC5M	CWA	1605	7.20	430	20	18	PC3	4.38	6.18	42(2x21)	480	n/a	n/a	1.97x3.66	3.9	30	n/a	n/a	C
230				7.29		20														C
240				6.80		20														C
(1) 70 WATT S62 HIGH PRESSURE SODIUM LAMP																				
220	S70230LC3M	HX-HPF	88	0.95	120	2	18	PC1	1.9	3.2	10	280	1.26	2.83	n/a	n/a	5.7	HPS150-3A	3	A
230				1.10		2														A
240				1.05		2														A
(1) 250 WATT S50 HIGH PRESSURE SODIUM LAMP																				
220	S250230AC4M	CWA	280	1.33	188	5	18	PC2	1.78	3.58	40	300	n/a	n/a	2.01x3.01	3.9	10.3	HPS400-3A	3	B
230				1.24		5														B
240				1.15		5														B
(1) 400 WATT S51 HIGH PRESSURE SODIUM LAMP (continued)																				
220	S400230AC4M	CWA	465	2.00	190	8	18	PC2	2.5	4.3	64	300	n/a	n/a	1.91x2.91	3.1	15.5	HPS400-3A	3	D
230				2.05		8														D
240				2.10		8														D
(1) 1000 WATT S52 HIGH PRESSURE SODIUM LAMP																				
220	S1000230AC5M	CWA	1100	5.10	445	15	15	PC3	4.0	5.8	36	525	n/a	n/a	1.96x3.65	4.25	27	HPS1000-4B	10	D
230				4.90		15														D
240				4.80		15														D

See page 4-34 for Reference Drawings and Wiring Diagrams.

HID
CORE & COIL

HID CORE & COIL BALLASTS 50 HERTZ

DESCRIPTION	SUFFIX *
For Ballast Only	000
For Capacitor Only (see pg. 5-5, 5-6)	500

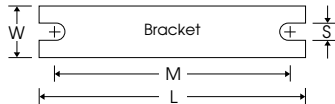

Ref. Dwg.	L	W	M	S
1	4.00"	0.75"	3.60"	0.25"
2, 3, 4	5.25"	1.75"	4.60"	0.25"
PC1	5.25"	1.25"	4.60"	0.25"
PC2	7.75"	1.25"	5.75"	0.25"
PC3	7.75"	2.75"	6.10"	0.25"

See p. 5-8 for adjustable mounting brackets and detailed bracket drawings.

REFERENCE DRAWING PC1

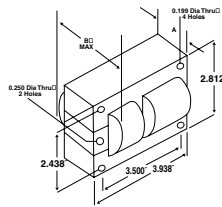

REFERENCE DRAWING PC3

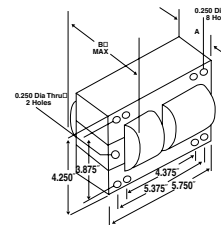

REFERENCE DRAWING PC2

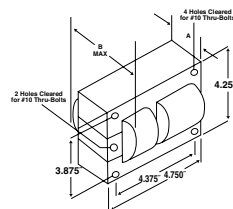

WIRING DIAGRAMS

Wiring Diagram 15

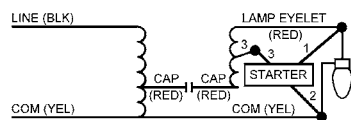

Wiring Diagram 16

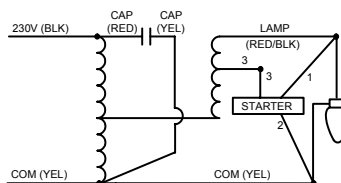

Wiring Diagram 17

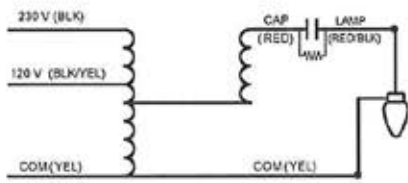

Optional 120V Standby Lamp 400 Watts Max.

Wiring Diagram 18

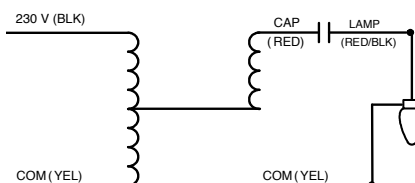

Note: Nominal dimensions provided above
Contact Universal for drawings and/or tolerances

F-CAN BALLASTS METAL HALIDE

- 60 Hz
- Minimum Starting Temperature: -30° C
- CWA and High Power Factor Designs

MH
35-400
WATT

Input Volts	Catalog Number	Circuit Type	Input Watts	Max Input Current	Nom Open Circuit Voltage	Fuse Rating	Wir Dia	Dimensions			Total Weight	Max Dist To Lamp (ft)	Sound Rating	Certifications	
								Overall Length	Case Length	Mtg Dim				UL	CSA
(1) 35/39 WATT M130 METAL HALIDE (with built-in ignitor)															
120	1120-251A-TC	CWA	55	0.50	225	2	21	9.50	8.35	8.85	3.0	20	B	Yes	Yes
(1) 50 WATT M110 METAL HALIDE (with built-in ignitor)															
120 or 277	11210-236C-TC	HX-HPF	70	0.64 0.28	240	3 2	20	11.75	10.56	11.14	11.0	20	B	Yes	Yes
(1) 70 WATT M85 METAL HALIDE (with built-in ignitor)															
120 or 277	11210-277C-TC ⁷	HX-HPF	98	2.00 0.90	250	6 3	20	11.75	10.56	11.14	11.0	20	B	Yes	Yes
(1) 70 WATT M98 METAL HALIDE (with built-in ignitor)															
120 or 277	11210-506C-TC ²²	HX-HPF	90	2.00 0.90	250	6 3	20	11.75	10.56	11.14	11.0	20	B	Yes	Yes
120 or 347	11210-554C-TC	HX-HPF	90	2.00 0.80	250	6 3	20	11.75	10.56	11.14	11.0	20	B	No	Yes
(1) 100 WATT M90 METAL HALIDE (with built-in ignitor)															
120 or 277	11210-239C-TC	HX-HPF	125	2.20 1.00	250	8 4	20	11.75	10.56	11.14	11.0	20	B	Yes	Yes
120 or 347	11210-606C-TC	HX-HPF	125	2.20 0.70	250	8 2	20	11.75	10.56	11.14	11.0	20	B	No	Yes
(1) 150 WATT M81 METAL HALIDE (with built-in ignitor)															
120 or 277	11210-242C-TC	HX-HPF	185	3.70 1.60	260	10 5	20	14.31	13.19	13.75	14.0	20	B	Yes	Yes
(1) 150 WATT M102 METAL HALIDE (with built-in ignitor)															
120 or 277	11210-539C-TC	HX-HPF	185	3.70 1.60	260	10 4	20	14.31	13.19	13.75	14.0	20	B	Yes	Yes
(1) 175 WATT M57 METAL HALIDE LAMP															
120 or 277	1110-245SC-TC	CWA	202	2.00 0.85	300	5 3	20	14.32	13.19	13.75	14.0	*	B	Yes	Yes
120 or 347	1110-564C-TC	CWA	205	1.75 0.62	300	5 2	20	11.75	10.55	11.10	14.0	*	B	Yes	Yes
(1) 250 WATT M58 METAL HALIDE LAMP															
120 or 277	1110-246C-TC ⁸	CWA	295	2.50 1.10	280	8 4	20	16.75	15.57	16.13	18.0	*	C	Yes	Yes
120 or 277	1111-246C-TC ²³	CWA	300	2.50 1.10	300	8 4	22	11.75	10.55	11.10	11.0	*	B	Yes	Yes
120 or 347	1110-566C-TC	CWA	295	2.50 0.95	285	8 3	20	16.65	15.55	16.10	17.5	*	C	Yes	Yes
(1) 400 WATT M59 METAL HALIDE LAMP															
120 or 277	1110-247SC-TC	CWA	463	4.00 1.75	300	10 5	20	19.25	18.06	18.63	22.0	*	C	Yes	Yes
120 or 277	1111-247SC-TC ²³	CWA	460	4.00 1.75	300	10 5	22	14.31	13.19	13.75	14.0	*	B	Yes	Yes
120 or 347	1110-568C-TC	CWA	460	4.30 1.50	300	10 4	20	19.25	18.05	18.60	22.0	*	C	Yes	Yes

⁷ This ballast may also be used with (1) 70 watt S88 High Pressure Sodium lamp.

²² M98 Designates Venture Lighting catalog numbers MH70/4/MED, C/4/MED or MS70/C/84/MED/W

⁸ This ballast can be used with a MH200 ignitor to operate (1) 250 watt M103 lamp. Consult Universal for instructions.

²³ Two of these ballasts are required to operate the lamp. Electrical data is for two ballasts, except for "Sound Rating," which is for each ballast

* Refer to Page 5-5.

See page 4-40 for Reference Drawings and Wiring Diagrams.

HID
CORE & COIL 50 HERTZ

F-CAN BALLASTS
HIGH PRESSURE SODIUM

- 60 Hz
- Minimum Starting Temperature: -40° C
- CWA and High Power Factor Designs

Input Volts	Catalog Number	Circuit Type	Input Watts	Max Input Current	Nom Open Circuit Voltage	Fuse Rating	Wir Dia	Dimensions			Total Weight	Max Dist To Lamp (ft)	Sound Rating	Certifications	
								Overall Length	Case Length	Mtg Dim				UL	CSA
(1) 35 WATT S76 HIGH PRESSURE SODIUM (with built-in starter)															
120 or 277	12210-261C-TC	HX-HPF	55	0.80 0.35	120	5 2	20	11.75	10.55	11.10	9.0	10	B	Yes	Yes
(1) 50 WATT S68 HIGH PRESSURE SODIUM (with built-in starter)															
120 or 277	12210-236C-TC	HX-HPF	71	1.05 0.45	125	3 2	20	11.75	10.55	11.10	9.0	10	B	Yes	Yes
(1) 70 WATT S62 HIGH PRESSURE SODIUM (with built-in starter)															
120 or 277	12210-237C-TC	HX-HPF	97	1.60 0.70	140	5 2	20	11.75	10.56	11.14	9.15	10	B	Yes	Yes
120 or 347	12210-552C-TC	HX-HPF	109	1.69 0.63	145	5 2	20	11.75	10.55	11.10	9.2	10	B	Yes	Yes
(1) 100 WATT S54 HIGH PRESSURE SODIUM (with built-in starter)															
120 or 277	12210-239C-TC	HX-HPF	125	2.00 0.90	130	5 3	20	11.75	10.55	11.10	10.4	10	B	Yes	Yes
120 or 347	12210-606C-TC	HX-HPF	126	2.10 0.90	165	6 3	20	11.75	10.55	11.10	10.4	10	B	Yes	Yes
(1) 150 WATT S55 HIGH PRESSURE SODIUM (with built-in starter)															
120 or 277	12210-241C-TC	HX-HPF	185	2.80 1.20	120	8 4	20	14.30	13.15	13.75	14.0	10	B	Yes	Yes
120 or 347	12210-602C-TC	HX-HPF	185	2.80 1.03	120	8 3	20	14.30	13.15	13.75	14.1	10	B	Yes	Yes

See page 4-40 for Reference Drawings and Wiring Diagrams.

HID CORE & COIL BALLASTS

F-CAN

F-CAN

F-CAN BALLASTS OPTIONAL ACCESSORIES

Mounting Bracket Assemblies

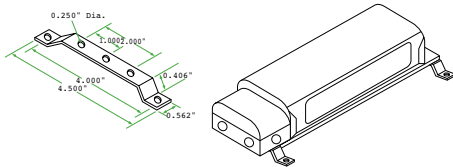

Catalog Number 2-BMB-1.

Available for the remote installation of ballasts. Each assembly consists of two (2) mounting brackets, four (4) screws, four (4) washers and four (4) nuts.

Tee-Pee Lead Wire Covers

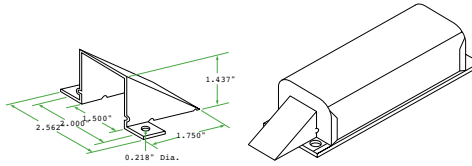

Catalog Number TP5. Ref. part #001-2013.

For use where ballast is attached to the surface of an enclosure or raceway.

Splice Box

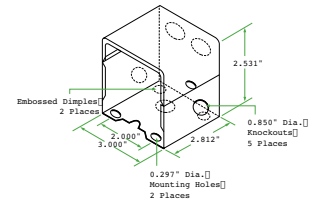

Catalog Number SB-4. Ref. part #001-2009

For use with all F-Can Ballasts. It is easily installed on the anchor bracket provided on each F-Can ballast. It contains five (5) 7/8\"/>

REFERENCE DRAWING FOR F-CAN

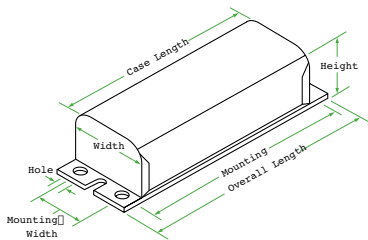

WIRING DIAGRAMS

Wiring Diagram 20

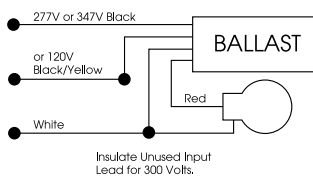

Wiring Diagram 21

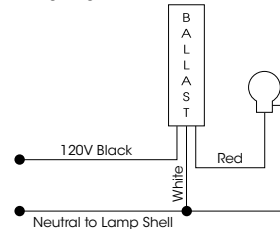

Wiring Diagram 22

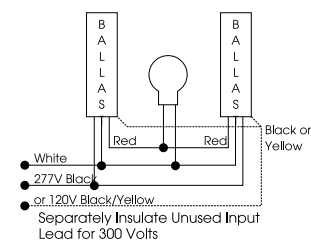

Note: Nominal dimensions provided above
Contact Universal for drawings and/or tolerances

STANDARD IGNITORS • INSTANT RESTRIKE IGNITORS • LONG DISTANCE IGNITORS • AUTOMATIC SHUTOFF IGNITORS • SHUTOFF DEVICES

Catalog Number	Description	Reference Drawing Number
--STANDARD IGNITORS		(See pg. 5-43)
PULSE START METAL HALIDE		
MH 70-3B ¹³	For double-ended MH lamps with HX-HPF ballasts: 70 watt (M85), 100 watt (M91), and 150 watt (M81)	29
MH 100-3A	For MH lamps with HX-HPF ballasts: 35/39w(M130), 50w(M110), 70w(M98), 100w(M90/M140), and 150w(M102/M142)	25
MH 150-1A	For 150 watt (M102/M142) lamp with CWA ballast	26
MH 200-1B ¹³	For double-ended MH 250 watt (M80) lamp	27a
MH 350-1A	For MH lamps with CWA ballasts: 175 watt (M152/M137), 200 watt (M136), 250 watt (M153/M138), 320 watt (M154/M132), 350 watt (M131), 400 watt (M155/M135), and 450 watt (M144)	26
P 750-1B ¹³	For 750 watt (M149) MH lamp	29
HPS 1000-4B ¹³	For MH lamps: 875 watt (M166) and 1000 watt (M141). It is also used for 1000W HPS lamps	29
HIGH PRESSURE SODIUM		
HPS 150-3A	For HPS lamps of 150 watt or less with HX-HPF ballast, except 150 watt S56 lamp	26
HPS 400-3A	For HPS lamps from 200 to 400 watts and 150 watt S56 lamp with CWA ballasts	26
HPS 450-1B ¹³	For 150 watt S56, 200, 250 or 400 watt lamps with 240 volt/60 Hz reactor ballasts. With attached mounting bracket.	27
HPS 460-1B ¹³	For 200, 250 and 400 watt lamps with HX-HPF ballasts and 50 Hz reactor ballasts. With attached mounting bracket.	27
HPS 600-1B	For 600 watt lamps.	27
HPS 1000-4B ¹³	For 1000 watt HPS and Pulse Start Metal Halide lamps. With attached mounting bracket.	29
HPS 1000-6B ¹³	Obsolete	29
PLUG REPLACEABLE IGNITORS		
PULSE START METAL HALIDE		
MH 150-G15	For MH lamps with HX-HPF ballasts: 35/39 watt (M130), 50 watt (M110), 70 watt (M98), 100 watt (M90/M140), and 150 watt (M102/M142)	32
HIGH PRESSURE SODIUM		
HPS 150-G01	For HPS lamps of 150 watt or less with HX-HPF ballast, except 150 watt S56 lamp	32
HPS 400-G05	For HPS lamps from 200 to 400 watts and 150 watt S56 lamp with CWA ballasts	32
INSTANT RESTRIKE IGNITORS		
HIGH PRESSURE SODIUM		
HPS 150-5B ¹³	Instant Restrike Ignitor — for lamps of 150 watts or less except 150 watt S56. Ignitor has attached mounting bracket.	30
LONG DISTANCE IGNITORS		
PULSE START METAL HALIDE		
MH 100-5A	For MH lamps from 35 to 50 watts. Max Ballast to Lamp Distance ($\approx 20'$)	25
MH 100-5A	For MH lamps from 70 to 150 watts. Max Ballast to Lamp Distance ($\approx 30'$)	25
MH UNV-5B	For MH lamps from 35 to 450 watts. Ignitor incorporates automatic resetting thermal protection. Max Ballast to Lamp Distance ($\approx 50'$)	33
HIGH PRESSURE SODIUM		
HPS 150-4A	For HPS lamps of 150 watt or less, except 150 watt S56 lamp. Max Ballast to Lamp Distance ($\approx 20'$)	24
HPS 400-4A	For HPS lamps from 200 to 400 watts and 150 watt S56 lamp. Max Ballast to Lamp Distance ($\approx 25'$)	33
AUTOMATIC SHUTOFF IGNITORS		
PULSE START METAL HALIDE		
MH 100-35B ¹³	For MH lamps: 35/39 watt (M130), 50 watt (M110), 70 watt (M98), 100 watt (M90/M140), and 150 watt (M102/M142). With attached mounting bracket	27
MH 150-35B ¹³	For 150 watt M81 lamp with CWA ballasts. With attached mounting bracket.	31
MH 350-15B ¹³	For MH lamps: 175 watt (M152/M137), 200 watt (M136), 250 watt (M153/M138), 320 watt (M154/M132), 350 watt (M131), 400 watt (M155/M135), and 450 watt (M144)	31
P 750-15B ¹³	For 750 watt (M149) MH lamp	31
HIGH PRESSURE SODIUM		
HPS 150-45B ¹³	For lamps of 150 watts or less except 150 watt S56. With attached mounting bracket.	27
HPS 400-45B ¹³	For lamps from 200 to 400 watts and 150 watt S56 with constant wattage autotransformer ballasts. With attached mounting bracket.	27
AUTOMATIC SHUTOFF DEVICES		
In addition to one-piece shutoff ignitors, automatic shutoff devices are available as separate components for use with the ignitors below.		
SA-100	HPS 150-3A, HPS 150-5B, HPS400-4A, HPS460-1B, MH100-5A, MH70-3B, MH100-3A, MH150-1A, MH350-1A, HPS150-4A, HPS400-3A, HPS600-1B, MHUNV-5B, MH200-1B	33a

¹³ May also be available without attached mounting bracket. Substitute "A" suffix for "B" suffix when ordering. Minimum quantities may apply.

Lamp Watts	ANSI Code	Circuit Type	Standard Igniters	Auto Shutoff	Instant Restrike	Long Distance Igniters
HIGH PRESSURE SODIUM IGNITORS						
35	S76	Reactor	HPS 150-3A	HPS 150-45B	HPS 150-5B	HPS 150-4A
50	S68	Reactor, HX	HPS 150-3A	HPS 150-45B	HPS 150-5B	HPS 150-4A
70	S62	Reactor, HX	HPS 150-3A	HPS 150-45B	HPS 150-5B	HPS 150-4A
100	S54	Reactor, HX	HPS 150-3A	HPS 150-45B	HPS 150-5B	HPS 150-4A
150	S55	Reactor, HX	HPS 150-3A	HPS 150-45B	HPS 150-5B	HPS 150-4A
150	S56	CWA	HPS 400-3A	HPS 400-45B	—	HPS 400-4A
250	S50	Reactor	HPS 450-1B	HPS 400-45B	—	HPS 400-4A
250	S50	CWA	HPS 400-3A	HPS 400-45B	—	HPS 400-4A
250	S50	HX	HPS 460-1B	HPS 400-45B	—	HPS 400-4A
400	S51	Reactor	HPS 450-1B	HPS 400-45B	—	HPS 400-4A
400	S51	CWA	HPS 400-3A	HPS 400-45B	—	HPS 400-4A
400	S51	HX	HPS 460-1B	HPS 400-45B	—	HPS 400-4A
600	S106	CWA	HPS 600-1B	—	—	—
1000	S52	CWA	HPS 1000-4B	—	—	—

Lamp Watts	ANSI Code	Circuit Type	Standard Igniters	Auto Shutoff	Long Distance Igniters
METAL HALIDE IGNITORS					
35	M130	Reactor	MH 100-3A	—	MH 100-5A
50	M110	HX	MH 100-3A	—	MH 100-5A
70	M85	HX	MH 70-3B	MH 70-35B	MH 100-5A
70	M98	HX	MH 100-3A	MH 100-35B	MH 100-5A
100	M90	Reactor	MH 100-3A	MH 100-35B	MH 100-5A
100	M90	CWA	MH 100-3A	MH 100-35B	MH 100-5A
100	M91	HX	MH 70-3B	—	—
150	M81	HX	MH 70-3B	—	—
150	M81	CWA	MH 150-35B	MH 150-35B	—
150	M102	HX	MH 100-3A	MH 100-35B	MH 100-5A
350	M131	Reactor	MH 70-3B	—	—
350	M131	HX	MH 70-3B	—	—

STANDARD IGNITORS

Standard Igniters are supplied with all Universal High Pressure Sodium and Metal Halide ballasts requiring igniters. These ballasts are supplied with an appropriate external ignitor unless the ignitor is permanently attached to or built into the ballast.

INSTANT RESTRIKE IGNITORS

An Instant Restrike Ignitor generates multiple pulses to restrike a lamp arc after a brief power interruption has extinguished it, without the typical 3-minute cool-down time. A Standard Ignitor cannot restrike an arc until the lamp has had time to sufficiently cool. Even though an Instant Restrike Ignitor can reinitiate the lamp arc immediately upon restoration of power, the lamp is still subject to warmup. The following chart is based on an S55 lamp.

Time Lamp Is Extinguished	Restrike Time	Light Output On Reignition	Lamp Warmup Time
1 second	2 seconds	87%	35 seconds
5 seconds	Instant	83%	70 seconds
15 seconds	Instant	76%	130 seconds
30 seconds	Instant	62%	190 seconds
1 minute	Instant	46%	255 seconds
Cold Start	Instant	36%	360 seconds

PLUG REPLACEABLE IGNITORS

Incorporates terminals and a separate mounting base to simplify construction and replacement.

LONG DISTANCE IGNITORS

Long Distance Igniters are used in situations where a ignitor must be mounted further from the lamp than is recommended for a standard ignitor. The maximum lamp to ignitor distance for these igniters is 50 feet, which may vary depending on the type of lamp, ballast, fixture, and wiring.

AUTOMATIC SHUTOFF IGNITORS

In the event of a lamp failure, a Standard Ignitor will continue to pulse, trying to start the lamp. This may reduce the life of the ignitor. An Automatic Shutoff Ignitor will apply pulses for 10 to 12 minutes and then deactivate if a lamp arc cannot be initiated. Resetting the ignitor is accomplished by momentarily interrupting the power to the ballast. For this reason, these igniters are not recommended for use on unswitched circuits.

AUTOMATIC SHUTOFF DEVICES

Automatic shutoff devices can be used with a standard ignitor to convert standard ignitor into an automatic shutoff ignitor. Simply use the automatic shutoff device with appropriate standard ignitor. Matching igniters are listed in the table on previous page. Automatic shutoff device coupled with standard ignitor is equivalent to automatic shutoff ignitor. Wiring diagrams of SA-100 automatic shutoff device are shown on Ref. Drawings 34a and 34b.

TEMPERATURE RATING

Most igniters are rated for a 105°C maximum case temperature. Consult ballast specification sheets at www.unvlt.com for specific details.

REFERENCE DRAWINGS

All dimensions in decimals.
All lead lengths: 13 inches ±1

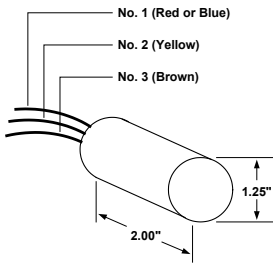

Ref. Drawing 24

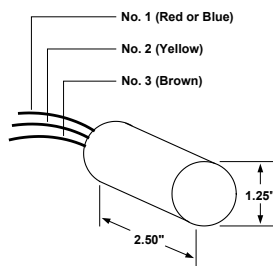

Ref. Drawing 25

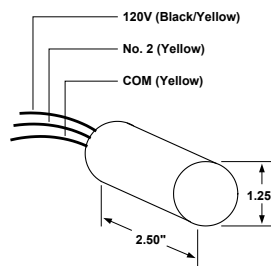

Ref. Drawing 25a

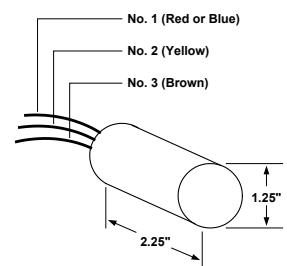

Ref. Drawing 26

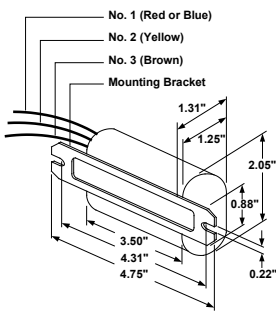

Ref. Drawing 27

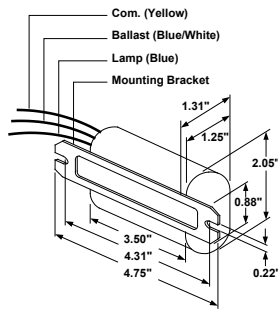

Ref. Drawing 27a

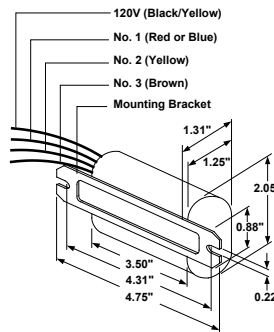

Ref. Drawing 28

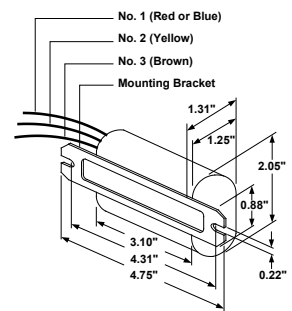

Ref. Drawing 29

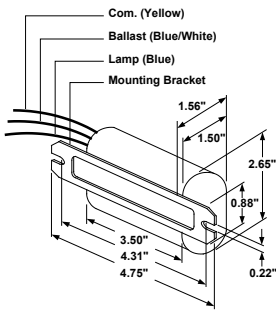

Ref. Drawing 30

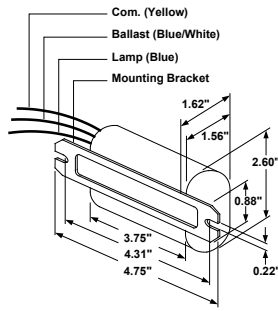

Ref. Drawing 31

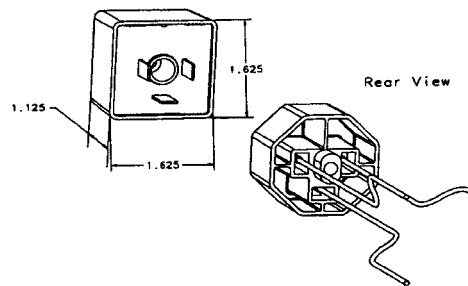

Ref. Drawing 32

Note: Nominal dimensions provided above
Contact Universal for drawings and/or tolerances

Notes

eHID

Less energy. Enhanced performances.

Experience significant energy savings and increased lumen output vs. halogen lamps with Electronic High Intensity Discharge (HID) ballasts from Universal Lighting Technologies. Vossloh-Schwabe (VS), also a Panasonic Lighting Company, recently merged its US operation into Universal. This merger combines Vossloh's market leading high quality electronic HID product line with Universal's extensive offering.

There are numerous advantages of using VS electronic HID ballasts. Operating HID lamps used in HID lighting systems with electronic ballasts greatly increases system efficiency in comparison with magnetic ballasts. These ballasts are designed to provide optimal lamp performance and maximum energy savings. With enhanced capabilities to downsize the form factor of luminaire housings and reduce wiring costs, VS electronic HID ballasts lead the way to electronic solutions for HID lighting. Micro-processor controlled intelligence offers superior lamp performance and the flexibility for proprietary value-added functions. VS electronic HID ballasts cover your HID needs with products for Metal Halide Lamps ranging from 20 Watts to 150 Watts.



VS electronic HID ballasts continuously monitors lamp characteristics during operation and adjusts the lamp current to optimize performance. This guarantees controlled operation in all modes of operation. The lamp color temperature is also stabilized by using VS electronic HID ballasts due to its relatively constant output power characteristics in addition to producing flicker free lighting that usually occurs at the end of the discharge lamp's service life. The technology enhancements of VS electronic HID ballasts, allowing very small form factors and light weight designs, has enabled new, innovative luminaire designs.

Product Overview

Micro Series: The introduction of the smallest eHID ballasts in the market was coordinated with the launch of the new miniaturized capsule MH lamps enabling the ultimate luminaire design flexibility. Extremely compact and aesthetically pleasing, luminaire designs are approaching the form factor and size of low voltage halogen systems.



Mini Ballast Series: Two ideal form factors that are used in millions of HID track light luminaires characterize the mini series of eHID ballasts. The mini-slim and mini-square units revolutionized track lighting by allowing significantly smaller and greater variety of luminaire designs while providing energy savings of 60-70% versus halogen systems.



Standard Case "Valued-added Series": Millions of recessed, track-head and specialty luminaires have used the de facto industry standard enclosure since introduction. The significant energy savings and enhanced reliability of our ballasts promoted the rapid escalation of electronically ballasted MH luminaires for almost 15 years. Technological advancements have now allowed the integration of multiple, value-added functions such as: a powersource for the self-heating thermal protectors, an electronic 277V step-down transformer, and an intelligent auxiliary lighting control for back-up lighting during lamp hot restrike modes. Ideal for new, retrofit and replacement applications in recessed luminaires.

Features and Benefits:

- Optimum lamp performance
- Rugged, compact and lightweight design
- High power factor
- Enhanced color and CRI uniformity
- Shut-down protection
- Reduced wiring costs
- Eliminates nuisance lamp cycling at end-of-lamp life (intelligent lamp sensing capabilities)
- Constant lamp power
- Reduced lamp dropouts due to improved line voltage dip withstand
- Quiet operation
- Durable performance for various applications
- Fewer SKUs required in inventory
- Broadens design flexibility for new applications and luminaries

eHID Product Family

Part #	Description	Lamp Wattage	Lamp Type	Input Voltage	Input Power	Mounting	Lead Exit	Dimensions	Wiring
Micro Series									
188514	M2012CK-7EUN	20	M/C156	120	24.5	No Feet	Side	1	1
188882	M2012CK-7EUN-F	20	M/C156	120	24.5	Feet	Side	2	1
188883	M2012CK-7EUN-J	20	M/C156	120	24.5	Studs	Top	3	1
188574	M2212CK-7EUN	22	M/C175	120	26.5	No Feet	Side	1	1
188884	M2212CK-7EUN-F	22	M/C175	120	26.5	Feet	Side	2	1
188885	M2212CK-7EUN-J	22	M/C175	120	26.5	Studs	Top	3	1
188635	M3912CK-7EUN	39	M/C130	120	45	No Feet	Side	4	1
188776	M3912CK-7EUN-F	39	M/C130	120	45	Feet	Side	2	1
188756	M3912CK-7EUN-J	39	M/C130	120	45	Studs	Top	3	1
188757	MTm3912CK-7EUN	39Tm	M/C179	120	45	No Feet	Side	4	1
188777	MTm3912CK-7EUN-F	39Tm	M/C179	120	45	Feet	Side	2	1
188758	MTm3912CK-7EUN-J	39Tm	M/C179	120	45	Studs	Top	3	1
Mini-Slim Series									
188246	M3912CK-6EUN-F	39	M/C130	120	45	Feet	Side	5	1
188164	M7012CK-6EUN-F	70	M/C98, M/C139, M/C143	120	77	Feet	Side	5	1
Mini-Square Series									
188901	M2012-27CK-6EU-F	20	M/C156	120-277	24	Feet	Side	10	1
188902	M2012-27CK-6EU-J	20	M/C156	120-277	24	Studs	Top	9	1
188903	M2012/27CK-6EU-JT3	20	M/C156	120/277	24/26	Studs	Top	9	2a,2b,2c
188895	M3912-27CK-6EU-F	39	M/C130	120-277	44	Feet	Side	10	1
188896	M3912-27CK-6EU-J	39	M/C130	120-277	44	Studs	Top	9	1
188897	M3912/27CK-6EU-JT3	39	M/C130	120/277	44/46	Studs	Top	9	2a,2b,2c
188939	M7012-27CK-6EU-F	70	M/C98, M/C139, M/C143	120-277	77	Feet	Side	10	1
188940	M7012-27CK-6EU-J	70	M/C98, M/C139, M/C143	120-277	77	Studs	Top	9	1
188941	M7012/27CK-6EU-JT3	70	M/C98, M/C139, M/C143	120/277	77/79	Studs	Top	9	2a,2b,2c
Standard Series									
188610	M2012-27CK-5EU-F	20	M/C156	120-277	24	Feet	Side	12	1
188611	M2012/27CK-5EU-JT3	20	M/C156	120/277	24/26	Studs	Top	13	2a, 2b, 2c
188156	M3912-27CK-5EU	39	M/C130	120-277	44	No Feet	Side	14	1
188157	M3912-27CK-5EU-F	39	M/C130	120-277	44	Feet	Side	12	1
188301	M3912-27CK-5EU-J	39	M/C130	120-277	44	Studs	Top	13	1
188629	M3912/27CK-5EU-JT3	39	M/C130	120/277	44/46	Studs	Top	13	2a, 2b, 2c
188630	M3912/27CK-5EU-JA3	39	M/C130	120/277	46/187	Studs	Top	13	3a, 3b, 3c
188612	M5012-27CK-5EU-F	50	M148 or M110	120-277	56	Feet	Side	12	1
188613	M5012/27CK-5EU-JT3	50	M148 or M110	120/277	56/58	Studs	Top	13	2a, 2b, 2c
188165	M7012-27CK-5EU	70	M/C98, M/C139, M/C143	120-277	78	No Feet	Side	14	1
188166	M7012-27CK-5EU-F	70	M/C98, M/C139, M/C143	120-277	78	Feet	Side	12	1
188167	M7012-27CK-5EU-J	70	M/C98, M/C139, M/C143	120-277	78	Studs	Top	13	1
188631	M7012/27CK-5EU-JT3	70	M/C98, M/C139, M/C143	120/277	79/81	Studs	Top	13	2a, 2b, 2c
188632	M7012/27CK-5EU-JA3	70	M/C98, M/C139, M/C143	120/277	81/212	Studs	Top	13	3a, 3b, 3c
188633	M10012/27CK-5EU-JT3	100	M/C90, M/C140 and M/C164	120/277	110/212	Studs	Top	13	2a, 2b, 2c
188168	M10012-27CK-5EU	100	M/C90, M/C140 and M/C164	120-277	110	No Feet	Side	14	1
188169	M10012-27CK-5EU-F	100	M/C90, M/C140 and M/C164	120-277	110	Feet	Side	12	1
188302	M10012-27CK-5EU-J	100	M/C90, M/C140 and M/C164	120-277	110	Studs	Top	13	1
188634	M10012/27CK-5EU-JA3	100	M/C90, M/C140 and M/C164	120/277	112/235	Studs	Top	13	3a, 3b, 3c
188638.05	M15012-27CK-5EU-F	150	M/C102/E and M/C142/E	120-277	163	Feet	Side	16	1
188639.05	M15012-27CK-5EU-J	150	M/C102/E and M/C142/E	120-277	163	Studs	Top	15	1
188989.05.1	M15012/27CK-5EU-JT3	150	M/C102 and M/C142	120/277	163/165	Studs	Top	15	2a, 2b, 2c

Footnotes:

- 1 - "JT3" models have 120V power source for operating the heater on self-heating thermal protectors allowing dual-rated input voltage fixtures.
- 2 - "JA3" models have same 120V power source as JT3 models, but also have an integrated auxiliary light control which drives a quartz restrike back-up lamp.
- 3 - Exceeds EISA 2007 90% minimum ballast efficiency requirement for 150W and higher HID lamp applications.

Wiring Diagrams

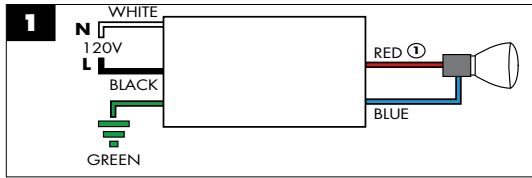

120/277V with IDTP Tap

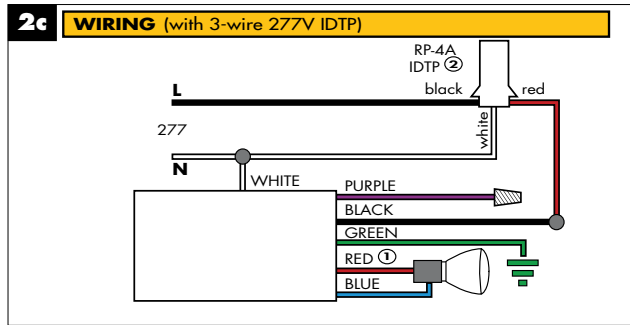
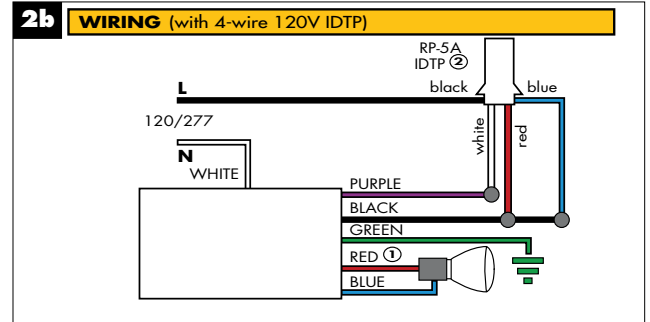
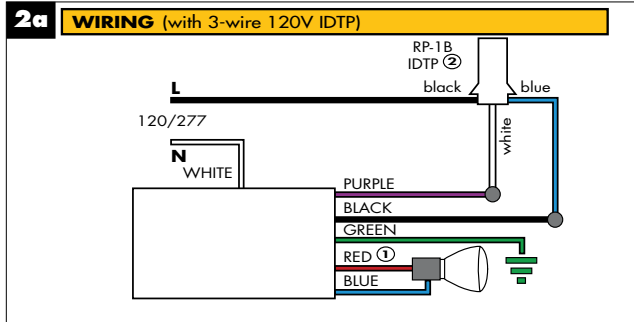

120/277V with Auxiliary Control + IDTP Tap

Wiring & Dimensions Diagrams (shown in millimeters and inches)

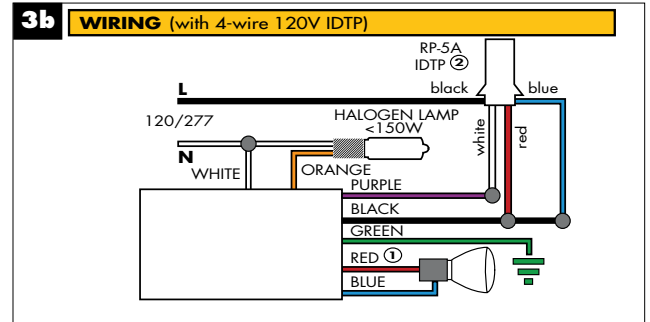
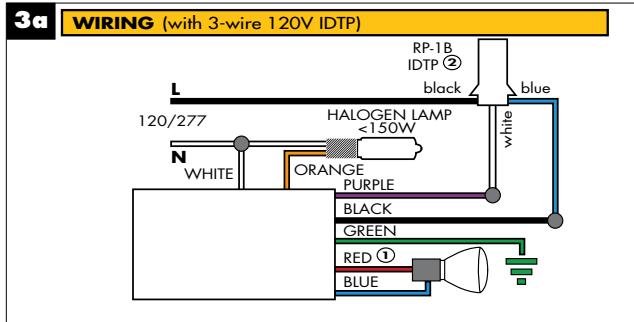

Notes for Wiring Diagram

- ① Connect red lead to center contact on Edison base lampholders
- ② IDTP - Insulation Detector Thermal Protector

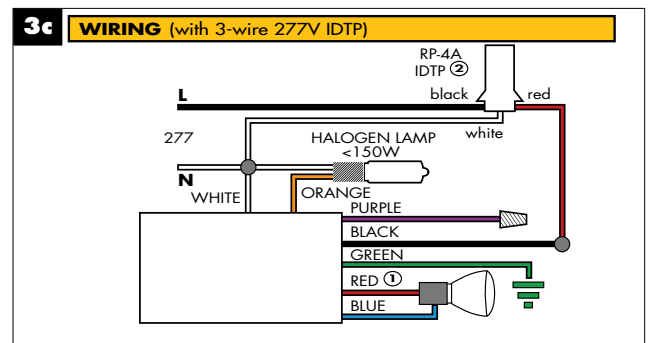

Dimming Ballasts

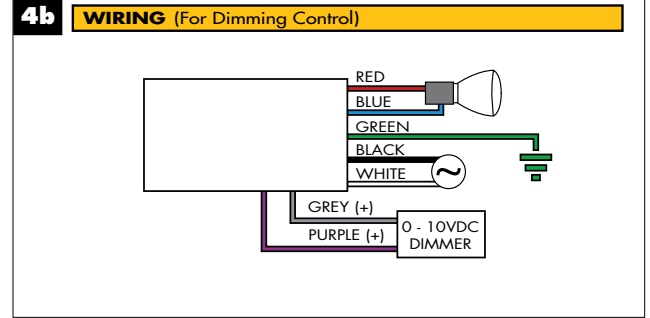
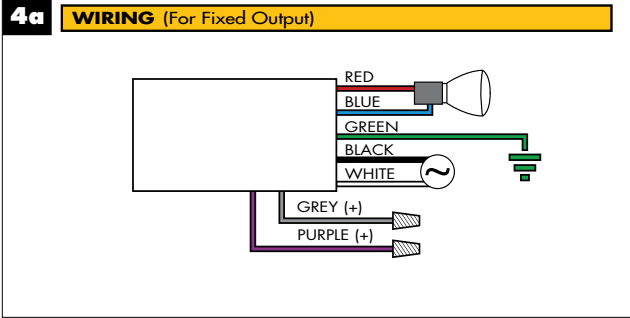

Dimensions

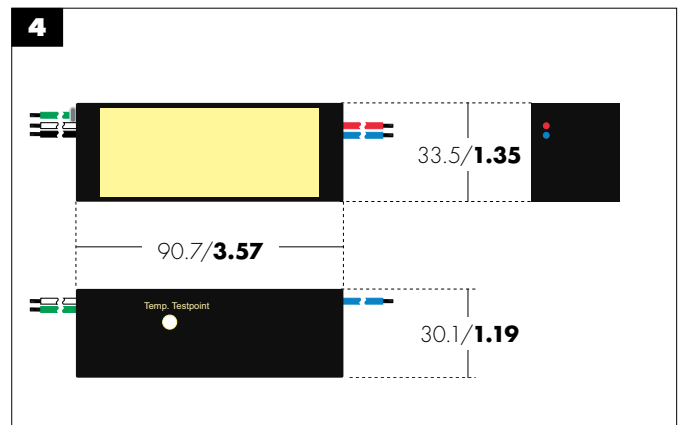
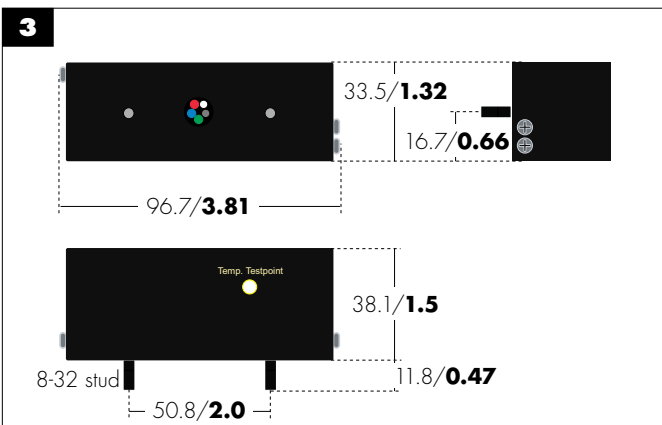
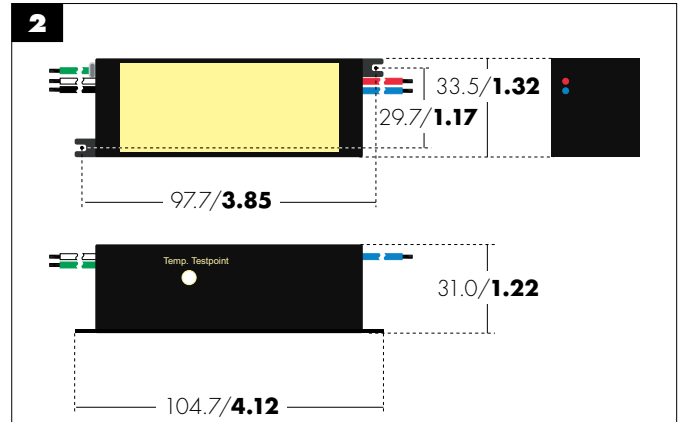
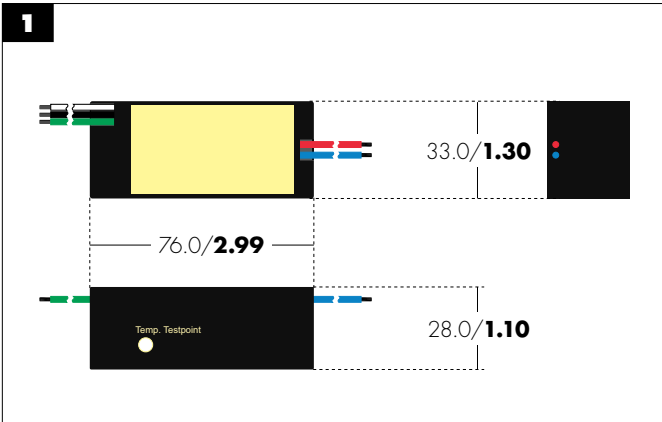

Dimensions

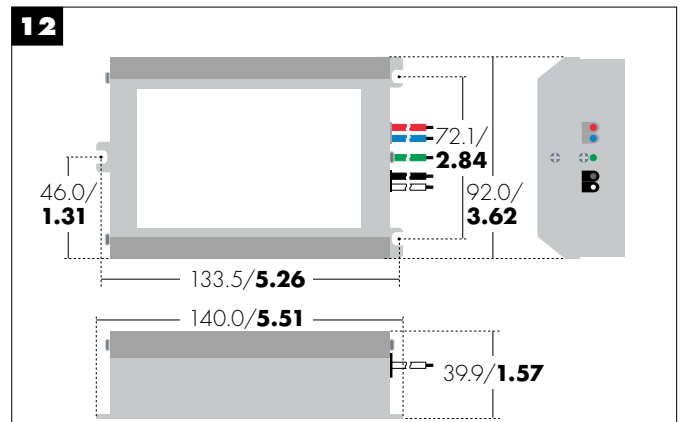
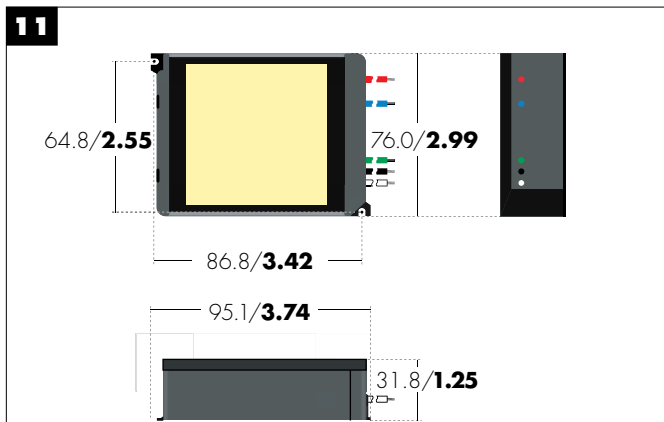
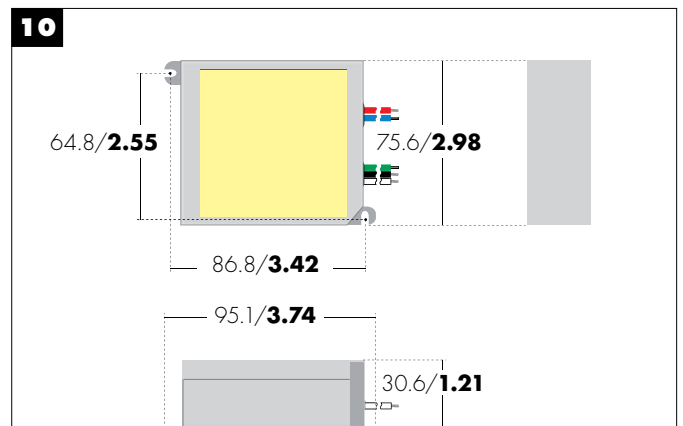
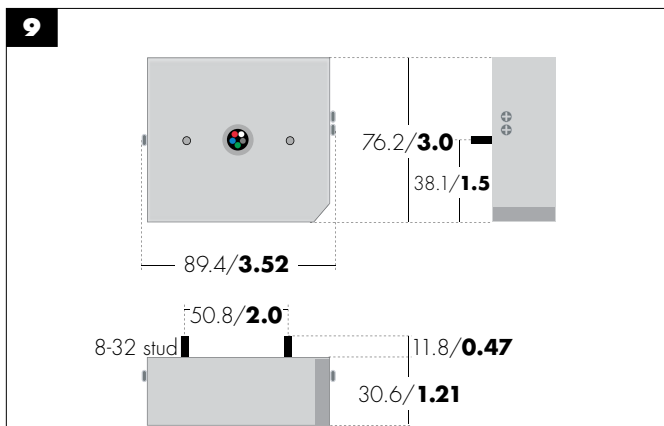
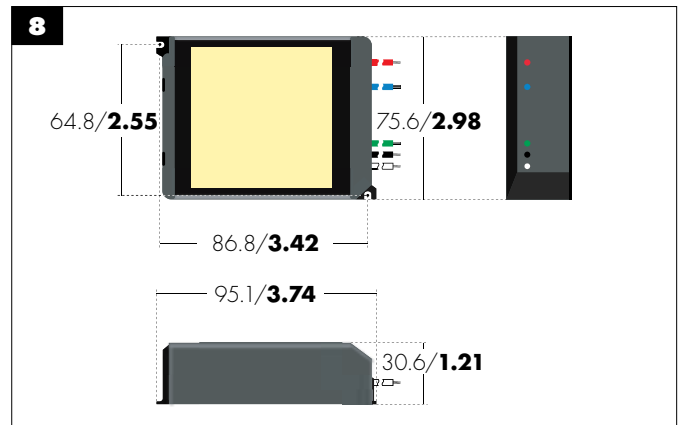
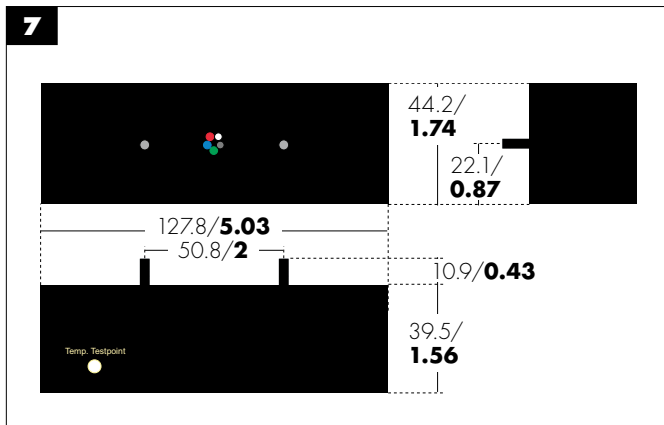
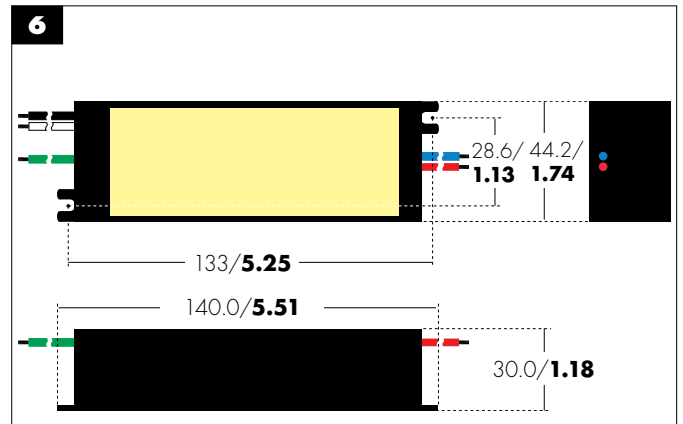
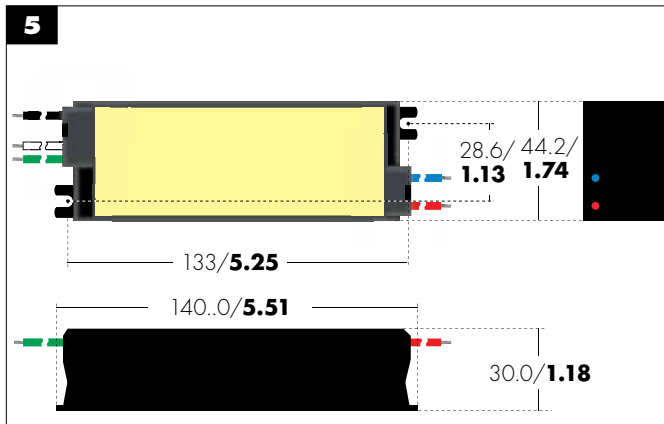

Dimensions

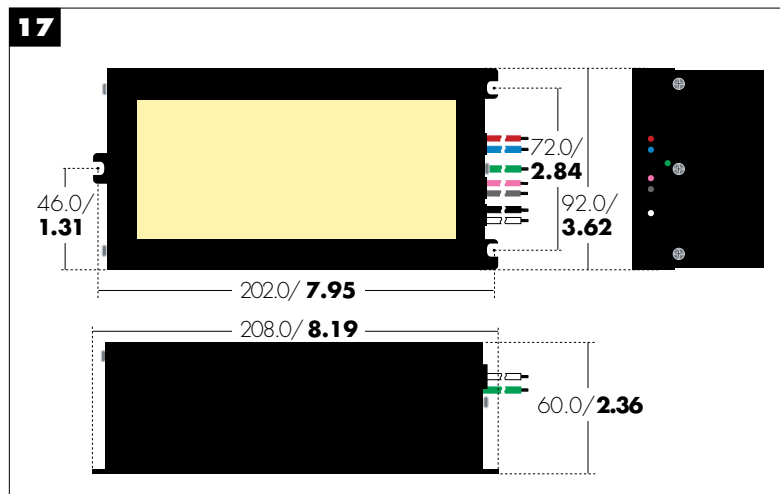
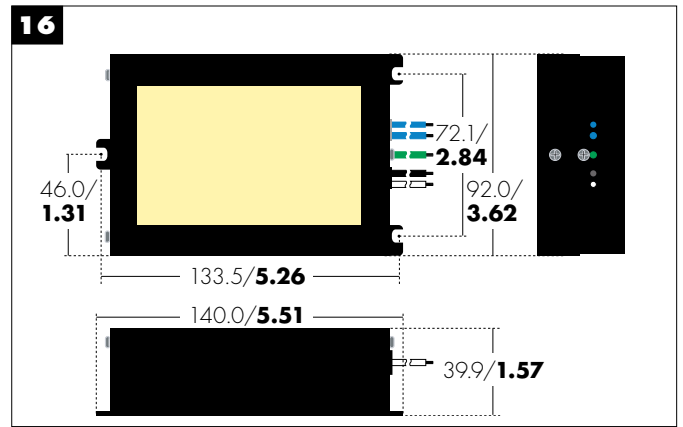
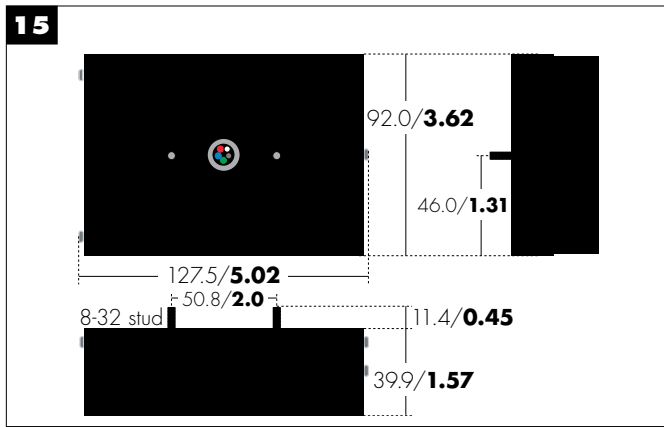
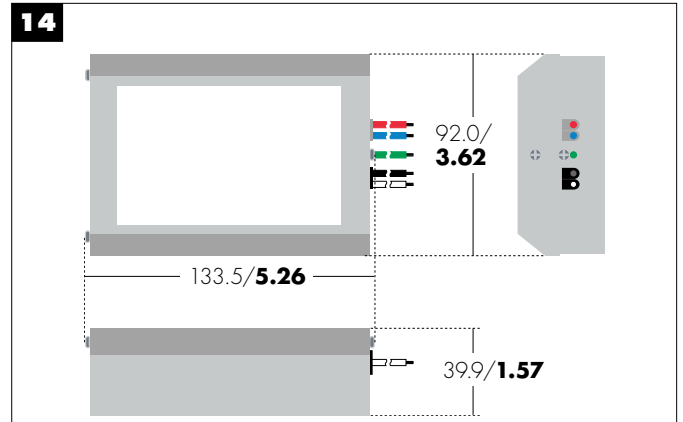
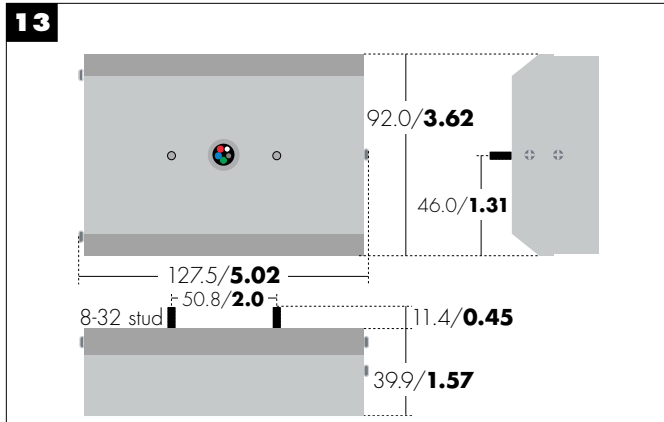

Application And Operating Information

General:

If the electrical current through an HID lamp is properly stabilized, an HID plasma arc with very high luminous efficiency is created in the arc tube chamber resulting in a very efficient light source. The internal pressure of the arc tube chamber rises as the arc tube temperature increases and will attain between 1 and 10 bar; thereby, defining these lamps as high-pressure HID lamps, high intensity discharge lamps or simply HID lamps. The light output and color rendition of HID lamps vary considerably depending on the lamp family (mercury, metal halide or sodium lamps).

HID lamps can only be started and operated with ballasts. Ignitors or ignition voltage characteristics are additionally required for sodium and metal halide lamps. As well as stabilizing the lamp's operating point, ballasts also influence the lamp's output and luminous flux, the system light output, the service life of the lamps as well as the color temperature of the light source.

Electromagnetic or electronic ballasts can be used for HID lamps, but unlike fluorescent lamps, lamp efficiency is not significantly improved by the use of electronic ballasts. However, electronic ballasts can lead to a reduction of the inherent losses and thus to an increase in system efficiency. In addition, electronic ballasts can ensure gentle lamp operation, which may increase lamp's service life.

Electronic Ballasts for Metal Halide Lamps

Electronic ballasts are designed with all the components required to operate metal halide lamps, including ignition, power factor correction, and stable normal operation. Furthermore, they safely shutdown lamps at the end of their service life to prevent high temperatures from being generated in the luminaires that could influence the service life of the luminaire or its components. Universal Lighting Technologies also provides special electronic ballasts for additional luminaire functions such as heater power for insulation detection thermal protectors and for switching on of an auxiliary incandescent lamp for the dark phase of an HID lamp during initial warm-up or during hot-restrike cool-down mode.

Standards/Regulations

ANSI C82.14 Low-Frequency Square Wave Electronic Ballasts for Metal Halide Lamps

UL 1598 Standard for Safety-Luminaires

ANSI C82.77 Harmonic Emission Limits-Related Power Quality Requirements or Lighting Equipment

ANSI/UL 1029 Standard for Safety-High Intensity HID Lamp Ballasts

ANSI/IEEE C62.41 Surge Voltages in Low Voltage AC Power Circuits

US Code of Federal Regulations Title 47 –Telecommunications Part 18– Industrial, Scientific and Medical Devices

Application And Operating Information

Technical Specifications:

Operating voltage range

120VAC rated: 120V 277V \pm 10%

277VAC rated: 277V \pm 10%

120–277V rated: 108V–305V

120/277V rated: 108V–132V and 249V–305V

Leakage current \leq 0.5mA

Hot restrike auxiliary lamp operation

In order to ensure continuous illumination even during the ignition period or in the event of a lamp drop-out due to short term power outage, an additional incandescent lamp (maximum 150W) can be used on models designated with a JA suffix.

Short circuit issues

The ballast output metal halide lamp leads are basically short-circuit-proof. However, any shorts or connections between those lamp leads to the ballast case or to safetyneutral (earth ground) will destroy the ballasts. Likewise the metal halide lamp leads shall not be connected to input power connections nor shall the auxiliary lamp leads be shorted together otherwise the ballast's circuitry could be damaged or fail.

Provisions in the luminaire design should be implemented to prevent all lead wires but especially lamp leads from being pinched, damaged, or cut during luminaire assembly, field installation or normal service.

Mechanical Mounting:

Surface

Firm, flat, preferably metal surface required to ensure good heat transfer for long ballast service life and reliability. Avoid mounting on uneven or protruding surfaces.

Mounting Location

Electronic ballasts must be protected against moisture and heat. Outdoor applications must utilize luminaires with the appropriate weatherproof ratings depending on location. Most Universal Lighting Technologies electronic ballasts are rated "Outdoor Type 1".

Fastening

Use mechanical means to ensure ballasts are fixed tightly to flat surfaces. Use appropriately sized screws depending on the ballast mounting slot size or spring clips to provide interference fit.

Heat transfer

If ballast is destined for installation in a luminaire, sufficient heat transfer must be ensured between the electronic ballast and the luminaire housing. Electronic ballasts should be mounted with the greatest possible clearance from heat sources or lamps. During operation, the temperature measured at the ballast's tc point must not exceed the specified maximum value.

Application And Operating Information

Technical Specifications:

- **Dimensional tolerances:**

- Case: $\pm 1\text{mm}$ ($\pm 0.039''$)
- Standard lead length tolerances: $+50\text{mm}$ ($+2''$) or -30mm ($-1''$) Micro lead length tolerances: $\pm 15\text{mm}$ ($\pm 0.6''$)
- Slot width on “F” mounting tabs: 5mm ($0.20''$); for Mini-Square Size: 4mm ($0.157''$)

- **Remote wiring guidelines:**

- Each lamp’s lead wires must be run in a separate conduit from the input power leads to achieve good EMI performance and maximum remote capabilities. Lamp leads shall not be bundled together, but each set of lamp leads shall be run in its own conduit.
- Individual lamp lead wires must be used for external fixture wire extensions using wire types SF-2 (equivalent to SEW-2 or 3071) or SFF-2 (equivalent to SEWF-2 or 3070) or alternately, if approved by ULT, high voltage luminaire wire with a 18AWG conductor and a 1000VAC minimum voltage rating. Temperature rating is especially critical if the lamp lead extension wires are directly connected to lampholder terminals.
- Maximum remote distances:
See individual model specification sheets.
The specified maximum remote distances are based on lamp leads run in a minimum $\frac{1}{2}''$ internal diameter conduit, pipe or flexible conduit. For longer remote distances contact the TES group at Universal Lighting.
- Using service power cords (types SJ, SO, ST, SV etc.) or metal clad cable assemblies for lamp lead extension wire are **not** recommended as they are not compatible with the above characteristics, can cause starting problems and shall not be used unless ULT gives written approval.

Insulation clearance

Remote mounted ballasts shall be installed per National Electrical Code and local codes while also complying with wiring methods per Universal Lighting Technologies recommendations. Per UL requirements, thermal insulation shall be a minimum of 3” from any ballast surface.

Application And Operating Information

Safety Functions:

Regulatory approvals

Universal Lighting Technologies electronic HID ballasts are UL listed or UL recognized component and cUL listed for use in Canada.

Shutdown of defective lamps

In the event of a lamp failing to ignite or of a lamp with low or high operating voltages (end of lamp's service life), the electronic ballast will switch off after a defined period of time (typically 30 minutes). The ballast will also shut-down if the lamp fails to achieve symmetrical current operation (rectification) or if lamp leads are shorted to each other. After lamp replacement, the ballast output can be reset by disconnecting (count to 10) and then reconnecting input power.

Transient input voltage

Electronic ballasts incorporate transient protection that complies with ANSI C62.41 and ANSI C82.14 test procedure and values.

Temperature Protection

To prevent excess temperatures, ballasts contain thermal protection devices or thermal sensing circuitry. A ballast will restart after it has cooled down, however, it might be necessary to briefly reset the input power after the over-temperature condition is resolved.

General guidelines

Always disconnect power to the luminaire before installation or service of the ballasts. Install to all provisions of local or National Electric Codes. The ballast case/green lead must be grounded. Dispose of any replaced ballasts or lamps properly per local environmental regulations.

Reliability and Service Life:

The electronic ballast service life is inversely proportional to the temperature of its critical internal components. Normal ballast operation shall have the temperature of the tc point less than the warranted values in the individual specification sheets

Electrical Installation:

3-Phase connection of luminaires with electronic ballasts

Prior to operating newly installed lighting systems, please check the ballast's rated voltage range to ensure it is appropriate for the job site input power supply voltage. The neutral power supply wire must be connected securely to all luminaires and to all ballasts. Power supply conductors must only be connected or disconnected when the circuit is not energized. The neutral conductor must never be disconnected as the first disconnected wire nor individually at the circuit panel, at a distribution wiring junction box or at the luminaire during energized power supply operation as out-of balance voltage operation can lead to serious over-voltages and subsequent ballast failures.

Power factor compensation

Luminaires with electronic ballasts do not need power factor compensation, as the typical power factor range of electronic ballasts is 95 to 99%.

Application And Operating Information

Wiring

Wiring between the power supply, electronic ballasts and lamp must comply with the respective circuit diagram.

Note: the ballast (metal) case (using toothed washer) or provided green lead must be connected to safety-neutral (earth ground). In addition, all metal luminaire parts and metal lamp reflector/housings shall also be connected to earth ground for safety and for proper lamp starting. Metal halide luminaires must only be fitted with electrical components that are rated to withstand ignition voltages of 4kV. To ensure compliance with RFI suppression limits, input and output conductors should not be run in the same conduit as lamp conductors. Conduit size recommendations are stated in the individual ballast specification sheets or construction notes.

Lamp maintenance notice

To replace end-of-service lamps, turn-off luminaire power, remove and replace lamps then turn-on luminaire power. If power was not turned off during lamp replacement, the luminaire/ballast-input power must be reset to restart the new lamp. If the lamp or wiring is defective, the ballast will “shut-down” in 1.5 to 30 minutes depending upon the fault condition.

Supplemental IDTP wiring

The IDTP (insulation detector thermal protector) is required by UL for most recessed luminaires. This fast acting thermal protector is typically mounted on the same junction box as the electronic ballast. Special “JT” electronic ballasts provide a separate 120V power supply for the IDTP heater to allow the luminaire to be rated for both 120V and 277V operation. See the individual ballast specifications for the proper wiring procedures for JT & JA ballasts with this IDTP heater function.

Note: When using JT or JA ballasts on multiple lamp luminaires, only one ballast yellow or purple lead should be connected to the IDTP heater. All other ballasts’ yellow or purple leads should be capped-off. Operation of JT and JA ballasts on 208V and 240V is not recommended, as the IDTP may not function properly.

Lamp compatibility

Not all HID lamps are compatible with all electronic ballasts. Therefore, consult with Universal Lighting Technologies Technical Support or a specific lamp company regarding a certain lamp’s compatibility.

External fuse ratings

All Universal Lighting Technologies electronic HID ballasts have internal fuses for EOL protection; however, if external fuses are specified, use a 3A slow blow fuse for 20W-100W ballasts and a 5A slow blow fuse for 150W & 210W ballasts.

Notes



VS

Vossloh Schwabe, a subsidiary of the Panasonic group, has been manufacturing and providing lampholders of the highest quality and reliability to the European and US markets since 1920. With products available to meet all your lamp, ballast, and fixture requirements, these lampholders will deliver peace of mind for years to come.

Application And Operating Information

Mounting Styles:

With the different fixture designs and applications in the market there are a number of lampholder mounting configurations available to meet all applications. These mounting styles, while demonstrated and geared towards linear fluorescent lamps, are also applicable to compact fluorescent lampholders as well.

Push Through:

The push through lampholder is the most common in the United States. This lampholder is inserted into a rectangular cut-out in the fixture and snaps into place with ballast wires being inserted into the base from underneath.



Snap-In:

Snap-In lampholders are available in two styles. The first is very similar application wise to the push through style with the difference being that it is pushed into the fixture from the top instead of the bottom. These lampholders wire from the bottom of the fixture as well. The second variant snaps in from the top as well but uses pin holes instead of a rectangular cutout. This allows the customer to use that actual fixture to mount the lampholder instead of a dedicated socket bar. Wiring this type of lampholders is done either through the bottom or laterally through the sides of the lampholder.



Butt On:

These lampholders are designed to mount directly to the sides of the fixture and are available with two mounting options. One has through holes for M3 screws, the second has pins either laterally or vertically across the back of the lampholder that snap into two pre-drilled holes in the fixture housing. Both models are available with spring mounts and two different thicknesses (9mm and 13.5mm). Contact egress is available from the side or bottom of the lampholder.

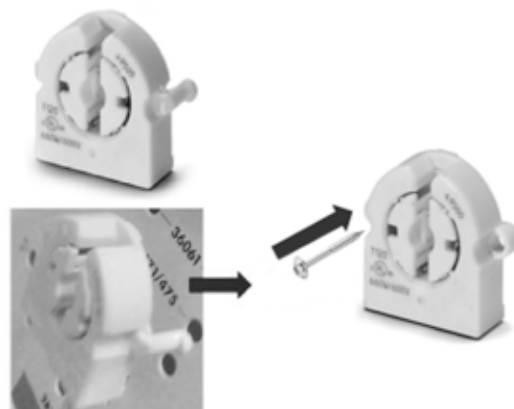

Application And Operating Information

Slide On:

These lampholders simply slide onto the end of a fixture into a knocked out channel. All version of this lampholder wire from the bottom.

Slides into existing channel at the end of the fixture



Rotor Styles:

Integrated Rotor:

Our integrated rotor system is a single piece construction that is simple and easy to use with no moving parts and an easy lamp insertion force.

Moving Rotor:

Moving rotor systems have a separate piece in the center of the lampholder that rotates with the lamp to aid in locking it in place. Two different systems are available; the Big Rotor system and our Roto-Clic system which has an audible click when the lamp is fully seated in the lampholder.

Shunting:

Non-Shunted lampholder have two individual contacts inside, one contact for each pin of the lamp. Each contact has its own separate wire terminal on either side of the lampholder. This type of lampholder is used with programmed or rapid start ballasts.

Shunted lampholders have one continuous contact running through the lampholder that electrically connects both pins of the lamp together. These lampholders will only have push in contacts on one side of the lampholder and are used with instant-start ballasts.

Lamp Axis:

Lamp axis is the distance from the surface of the fixture to the center of the lamp. For T8 and T12 lamps, these are commonly referred to as low profile for T8 only (16mm), standard (23mm), and tall (31mm) and can vary by a couple mm from manufacturer to manufacturer.

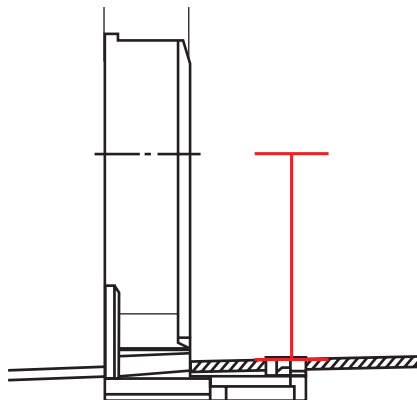

Application And Operating Information

Lamp Stop:

Lamp stop or “nib” as it is sometime called is a small pin the extends up from the front of some push through lampholders. This can be used to assist in locating the lampholder in the fixture or to help provide a slight inward rake to the lampholder.



Lampholder Springs:

Butt-On style lampholders can be purchased with or without a spring. These are small metal clips on the rear of the lampholder that help to provide compression on the lamp. They can be used on either side of the fixture or both as required by the manufacturer.



Circle I:

This stems from a UL requirement for instant start systems to contain either a type CC rated ballast or a “Circle I” rated lampholder. At this time, all of our shunted or instant start lampholders meet this requirement and are marked accordingly with the ① mark.

Nomenclature:

Our lampholders carry both a type number and a reference number. The type number is more like a family number where the numeric character signify similarities and differences as you progress through the five digit number. For example, the 291xx series are all 23mm, push-through, lampholders for T8/T12 lamps. As you move further into these numbers it signifies other identifiers like shunting and stopping pins. The reference number is the orderable number that is used to order the exact product.

Packaging:

Standard packing through ULT is in full bag quantities. For linear fluorescent lampholders this is commonly 1,000 piece, for compact fluorescent 500, and for HID, Halogen, and eHID this ranges from 10-250 pieces. Packing quantities vary by model and are listed on all spec sheets.

A select number of our lampholders are available in smaller “distributor friendly” packages, please consult your ULT sales representative for more information.

Snap-In Lampholders

Type	Reference Number	Lamps	Lamp Axis (mm)	Shunted	Push-In Terminals	Recommended Cut-Out (mm)	Drawing	Weight	Unit Pcs.
23370	539128	T8	18	-	Lateral	ø5.5 x 23	1	5.3	1000
23372	539140	T8	18	Shunted Right	Lateral	ø5.5 x 23	1	5.3	1000
23374	539141	T8	18	Shunted Left	Lateral	ø5.5 x 23	1	5.3	1000
24350	537153	T8/T12	23.5	-	Base	ø5.5 x 23	2	5.7	1000
24352	536320	T8/T12	23.5	Shunted	Base	ø5.5 x 23	2	5.7	1000
23350	537157	T8/T12	23.5	-	Lateral	ø5.5 x 23	1	5.8	1000
23352	536293	T8/T12	23.5	Shunted Right	Lateral	ø5.5 x 23	1	5.8	1000
23354	536294	T8/T12	23.5	Shunted Left	Lateral	ø5.5 x 23	1	5.8	1000
24360	537155	T8/T12	30	-	Base	ø5.5 x 23	2	5.9	1000
24362	536322	T8/T12	30	Shunted	Base	ø5.5 x 23	2	5.9	1000
23360	537160	T8/T12	30	-	Lateral	ø5.5 x 23	1	6	1000
23362	536284	T8/T12	30	Shunted Right	Lateral	ø5.5 x 23	1	6	1000
23364	537160	T8/T12	30	Shunted Left	Lateral	ø5.5 x 23	1	6	1000
24150	537144	T8	18	-	Lateral	13.3 x 25.5	3	5.4	1000
21452	536309	T8	18	Shunted Right	Lateral	13.3 x 25.5	3	5.4	1000
24154	536310	T8	18	Shunted Left	Lateral	13.3 x 25.5	3	5.4	1000
24140	537141	T8	18	-	Lateral	10 x 20	5	6	1000
24142	536306	T8	18	Shunted Right	Lateral	10 x 20	5	6	1000
24144	536307	T8	18	Shunted Left	Lateral	10 x 20	5	6	1000
24170	537150	T8/T12	21	-	Lateral	13.3 x 25.5	3	5.6	1000
24172	536315	T8/T12	21	Shunted Right	Lateral	13.3 x 25.5	3	5.6	1000
24174	536316	T8/T12	21	Shunted Left	Lateral	13.3 x 25.5	3	5.6	1000
24160	537147	T8/T12	21	-	Lateral	10 x 20	5	6	1000
24162	536312	T8/T12	21	Shunted Right	Lateral	10 x 20	5	6	1000
24164	536313	T8/T12	21	Shunted Left	Lateral	10 x 20	5	6	1000
24100	537132	T8/T12	25	-	Lateral	13.3 x 25.5	3	9	1000
24102	536297	T8/T12	25	Shunted Right	Lateral	13.3 x 25.5	3	9	1000
24104	536298	T8/T12	25	Shunted Left	Lateral	13.3 x 25.5	3	9	1000
24110	537165	T8/T12	25	-	Lateral	13.3 x 25.5	4	9	1000
24112	536300	T8/T12	25	Shunted Right	Lateral	13.3 x 25.5	4	9	1000
24114	536301	T8/T12	25	Shunted Left	Lateral	13.3 x 25.5	4	9	1000
24120	537138	T8/T12	25	-	Lateral	10 x 20	5	5.7	1000
24122	536303	T8/T12	25	Shunted Right	Lateral	10 x 20	5	5.7	1000
24124	536304	T8/T12	25	Shunted Left	Lateral	10 x 20	5	5.7	1000

* Consult www.UNVLT.com for complete lampholder offering and complete specs.

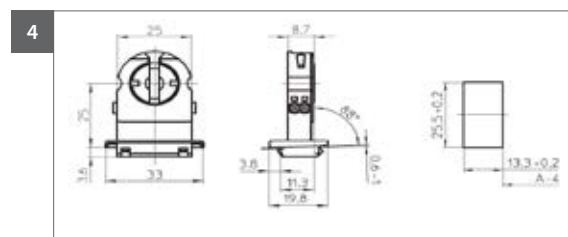
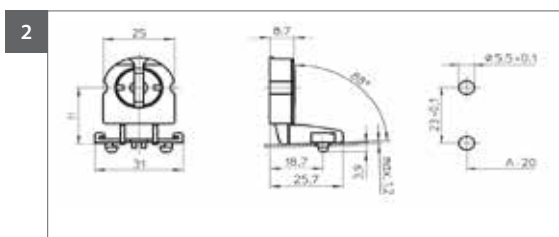
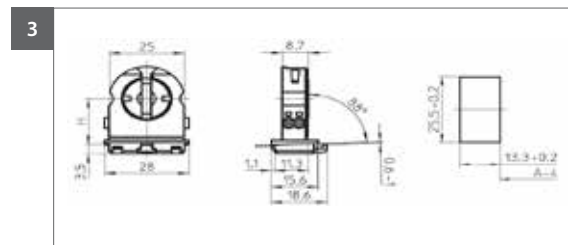
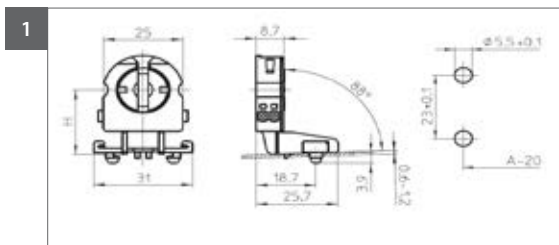

Push-Through Lampholders

Type	Reference Number	Lamps	Lamp Axis (mm)	Shunted	Lamp Stop	Recommended Cut-Out (mm)	Drawing	Weight (g)	Unit Pcs.
29300	509134	T8	16	-	W/ Stop	9 x 25.5	6	4.7	1000
29300	509136	T8	16	Shunted	W/ Stop	9 x 25.5	6	4.7	1000
29301	509135	T8	16	-	-	9 x 25.5	6	4.5	1000
29301	509137	T8	16	Shunted	-	9 x 25.5	6	4.5	1000
29100	545845	T8/T12	23	-	W/Stop	9 x 25.5	7	6.8	1000
29101	545849	T8/T12	23	-	-	9 x 25.5	7	6.8	1000
29125	545840	T8/T12	23	Shunted	W/Stop	9 x 25.5	7	6.8	1000
29126	545842	T8/T12	23	Shunted	-	9 x 25.5	7	6.8	1000
28700	109342	T8/T12	31	-	W/ Stop	9 x 25.5	9	7.8	1000
28725	109376	T8/T12	31	Shunted	W/ Stop	9 x 25.5	9	7.8	1000
28701	109343	T8/T12	31	-	-	9 x 25.5	9	7.8	1000
28726	109377	T8/T12	31	Shunted	-	9 x 25.5	9	7.8	1000

* Consult www.UNVLT.com for complete lampholder offering and complete specs.

Slide-On Lampholders

Type	Reference Number	Lamps	Lamp Axis (mm)	Shunted	Lamp Stop	Recommended Cut-Out (mm)	Drawing	Weight (g)	Unit Pcs.
29150	545858	T8/T12	23	-	0.5 - 0.8	9.15 x 26.2	10	6.8	1000
29155	545862	T8/T12	23	Shunted	0.5 - 0.8		10	6.8	1000

* Consult www.UNVLT.com for complete lampholder offering and complete specs.

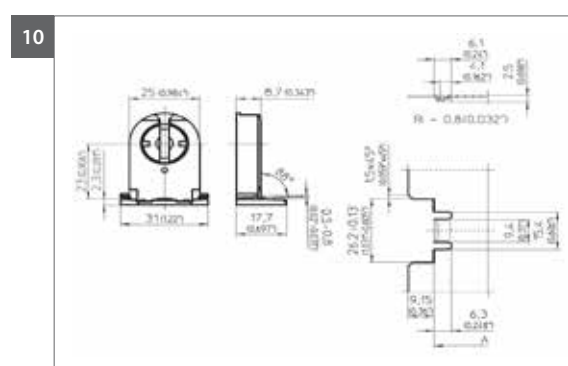
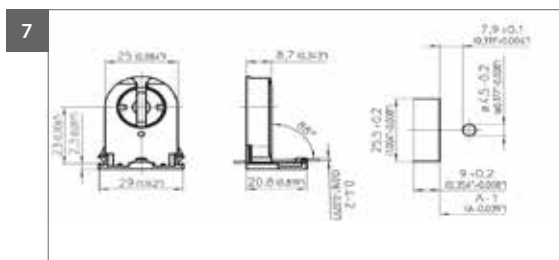
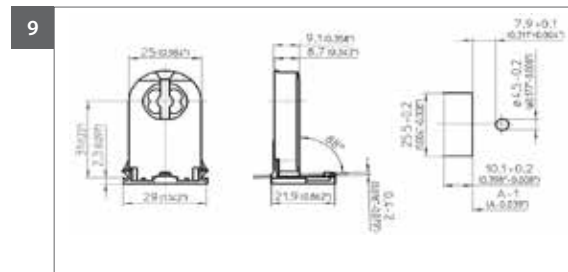
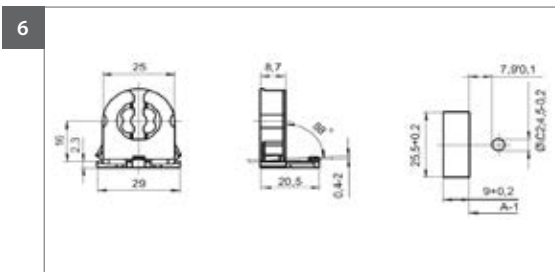

Butt-On Lampholders

Type	Reference Number	Lamps	Lampholder Thickness	Shunted	Spring Adjustment	Recommended Cut-Out (mm)	Drawing	Weight	Unit Pcs.
49505	537174	T8/T12	9.5	-	-	ø4.2 x 26	11	5	1000
49525	536337	T8/T12	9.5	Shunted	-	ø4.2 x 26	11	5	1000
49506	537175	T8/T12	9.5	-	X	ø4.2 x 26	12	5.5	1000
49526	536338	T8/T12	9.5	Shunted	X	ø4.2 x 26	12	5.5	1000
59505	537206	T8/T12	9.5	-	-	ø4.2 x 26	13	4.8	1000
59525	536369	T8/T12	9.5	Shunted Right	-	ø4.2 x 26	13	4.8	1000
59545	536373	T8/T12	9.5	Shunted Left	-	ø4.2 x 26	13	4.8	1000
59506	537207	T8/T12	9.5	-	X	ø4.2 x 26	14	4.8	1000
59526	536370	T8/T12	9.5	Shunted Right	X	ø4.2 x 26	14	4.8	1000
59546	536347	T8/T12	9.5	Shunted Left	X	ø4.2 x 26	14	4.8	1000
49105	537166	T8/T12	13	-	-	ø4.2 x 26	11	5.1	1000
49125	536329	T8/T12	13	Shunted	-	ø4.2 x 26	11	5.2	1000
49106	537167	T8/T12	13	-	X	ø4.2 x 26	12	5.9	1000
49126	536330	T8/T12	13	Shunted	X	ø4.2 x 26	12	5	1000
59105	537182	T8/T12	13	-	-	ø4.2 x 26	13	5	1000
59125	536325	T8/T12	13	Shunted Right	-	ø4.2 x 26	13	5	1000
59145	536349	T8/T12	13	Shunted Left	-	ø4.2 x 26	13	5	1000
59106	537183	T8/T12	13	-	X	ø4.2 x 26	14	5	1000
59126	536346	T8/T12	13	Shunted Right	X	ø4.2 x 26	14	5	1000
59146	536350	T8/T12	13	Shunted Left	X	ø4.2 x 26	14	5	1000
49500	537173	T8/T12	9.5	-	-	Holes 25mm O.C.	15	5	1000
49520	536336	T8/T12	9.5	Shunted	-	Holes 25mm O.C.	15	5	1000
47502	101740	T8/T12	9.5	-	X	Holes 25mm O.C.	16	5.5	1000
59500	537205	T8/T12	9.5	-	-	Holes 25mm O.C.	17	4.7	1000
59520	536368	T8/T12	9.5	Shunted Right	-	Holes 25mm O.C.	17	4.7	1000
59541	536372	T8/T12	9.5	Shunted Left	-	Holes 25mm O.C.	17	4.7	1000
49100	537165	T8/T12	13	-	-	Holes 25mm O.C.	15	5	1000
49120	536328	T8/T12	13	Shunted	-	Holes 25mm O.C.	15	5	1000
47102	404681	T8/T12	13	-	X	Holes 25mm O.C.	16	6	1000
59100	537181	T8/T12	13	-	-	Holes 25mm O.C.	17	5	1000
59420	536344	T8/T12	13	Shunted Right	-	Holes 25mm O.C.	17	5	1000
59140	536348	T8/T12	13	Shunted Left	-	Holes 25mm O.C.	17	5	1000

* Consult www.UNVLT.com for complete lampholder offering and complete specs.

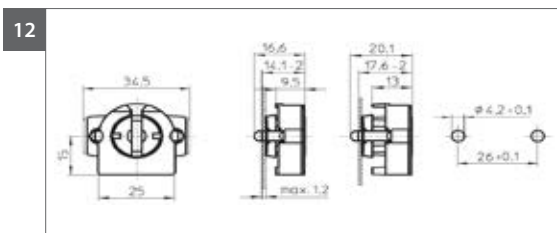
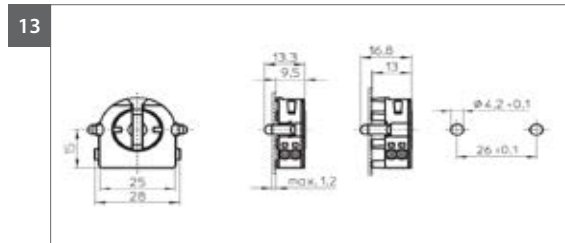
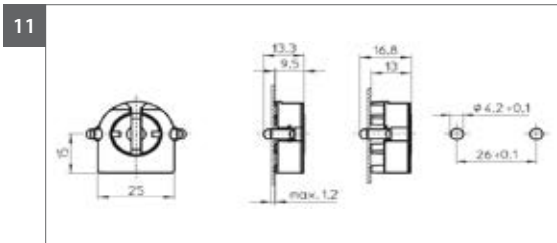

LAMP HOLDERS

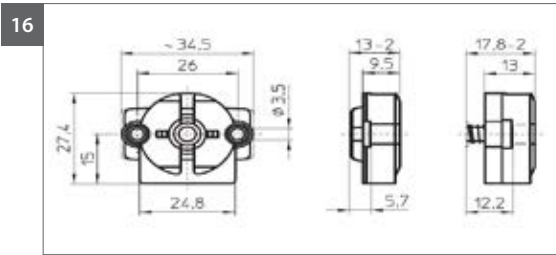
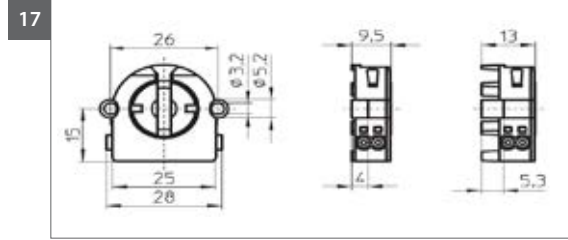
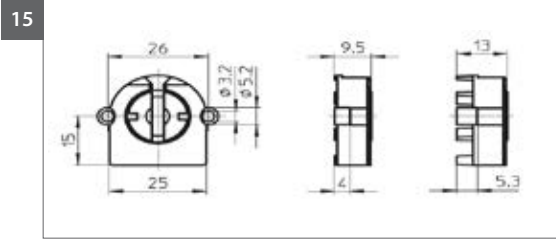

Push-Through Lampholders

Type	Reference Number	Lamps	Lamp Axis	Lamp Stop	Recommended Cut-Out (mm)	Drawing	Weight	Unit Pcs.
09420	505737	T5/T5HO	15	X	9.7 x 19.5	1	3.4	1000
09421	505739	T5/T5HO	15	-	9.7 x 19.5	1	3.3	1000
09432	545933	T5/T5HO	20	X	9.7 x 19.5	2	3.6	1000
09433	545935	T5/T5HO	20	-	9.7 x 19.5	2	3.6	1000
09434	545937	T5/T5HO	25	X	9.7 x 19.5	3	3.9	1000
09435	545939	T5/T5HO	25	-	9.7 x 19.5	3	3.9	1000
09426	505745	T5/T5HO	35	X	9.7 x 19.5	4	4.5	1000
09427	505746	T5/T5HO	35	-	9.7 x 19.5	4	4.5	1000
09105	100305	T5/T5HO	13.2	Screw Fixing	9.7 x 19.5	5	3.2	1000

* Consult www.UNVLT.com for complete lampholder offering and complete specs.

Snap-In Lampholders

Type	Reference Number	Lamps	Lamp Axis	Lamp Stop	Recommended Cut-Out (mm)	Drawing	Weight	Unit Pcs.
09440	505747	T5/T5HO	14		9.7 x 19.5	6	3.3	1000
09446	545894	T5/T5HO	18		9.7 x 19.5	7	3.5	1000
09447	545896	T5/T5HO	23		9.7 x 19.5	8	3.8	1000
09450	505750	T5/T5HO	15		ø3.7 x 13.2	9	3.4	1000
09460	505751	T5/T5HO	11.8		ø3.2 x 19.5	10	3.1	1000
09465	508314	T5/T5HO	11.8	ø3.2 x 18	ø3.2 x 19.5	11	3.1	1000

* Consult www.UNVLT.com for complete lampholder offering and complete specs.

Butt-On Lampholders

Type	Reference Number	Lamps	Lampholder Thickness	Spring Adjustment	Recommended Cut-Out (mm)	Drawing	Weight	Unit Pcs.
09404	505732	T5/T5HO	9.3	-		13	2.8	1000
09405	505733	T5/T5HO	9.3	-	ø3.8 x 20	14	2.9	1000
09406	505734	T5/T5HO	9.3	X	ø3.8 x 20	14	3.3	1000
09407	508590	T5/T5HO	12.5	-	ø3.8 x 20	15	3	1000
09415	505735	T5/T5HO	9.3	-	ø3.8 x 10	16	2.9	1000
09416	505736	T5/T5HO	9.3	X	ø3.2 x 10	16	3.2	1000
09205	100310	T5/T5HO	9.3	-	ø3.2 x 10	17	2.5	1000

* Consult www.UNVLT.com for complete lampholder offering and complete specs.

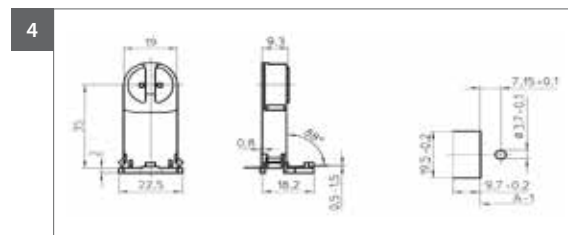
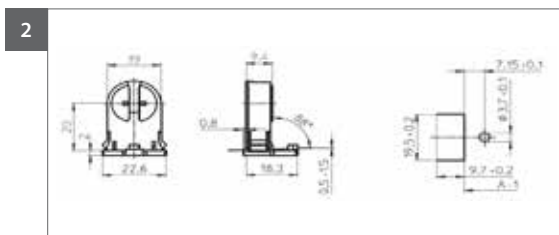
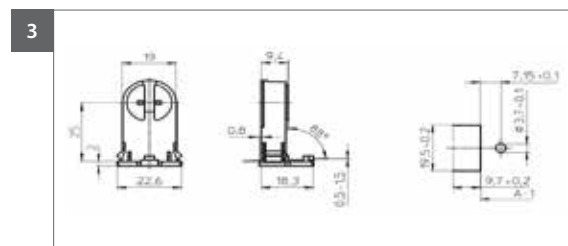
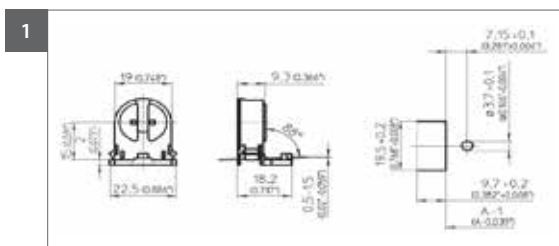

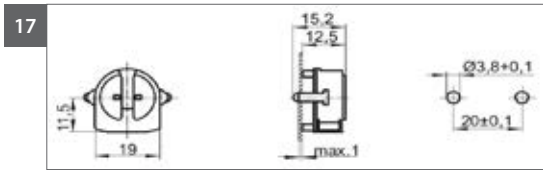
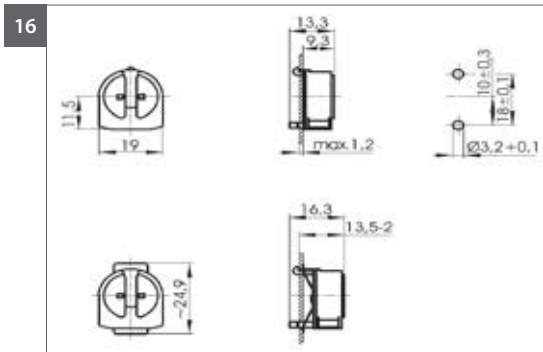
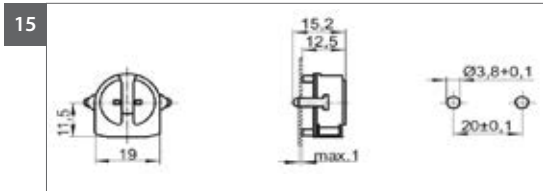
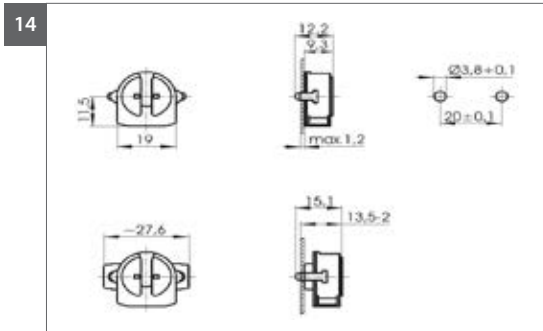
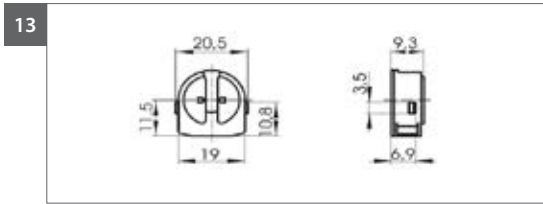
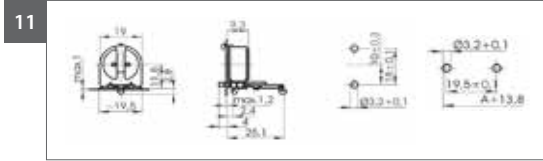
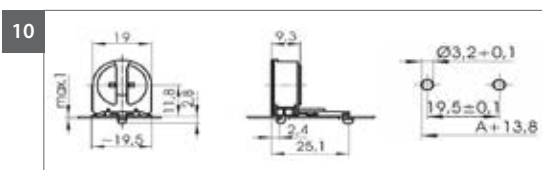
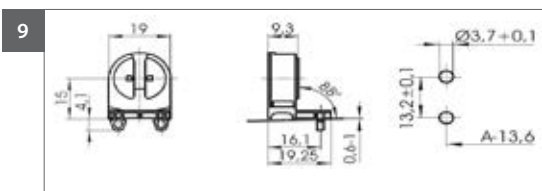
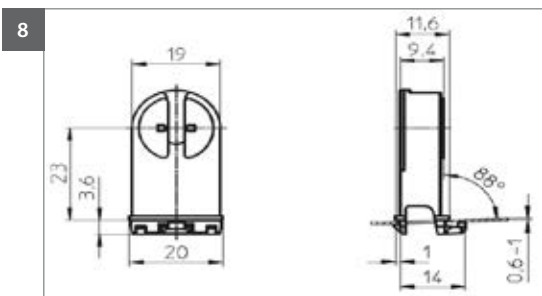
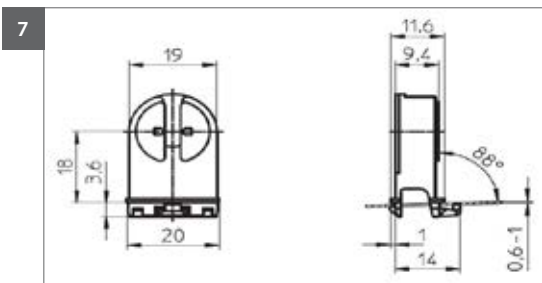
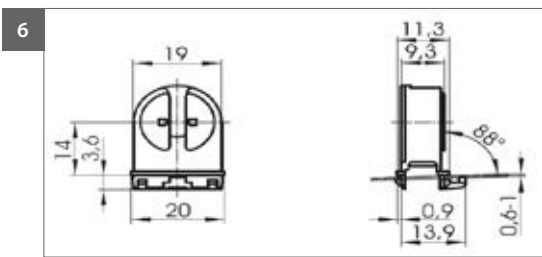
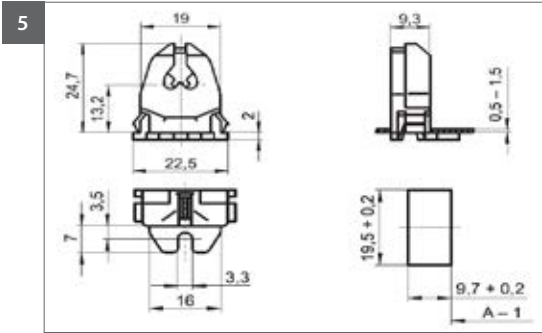

GU6.5, G8.5, GX8.5, GY9.5, GX10, G(X)12, K12S-7, PGJ5, RX7s Lampholders

HID

Type	Reference Number	Lamp Type	Material	Mounting	Lead Length	Lead Material	Drawing	Weight	Unit Pcs.
GU6.5									
34515	534218	GU6.5	Ceramic	#4 Screw Holes 15mm OC	305mm	PTFE	1	20	100
34516	534219	GU6.5	Ceramic	Threaded #4 Holes 15mm OC	305mm	PTFE	1	20	100
34525	538634	GU6.5	Ceramic	#4 Screw Holes 15mm OC	200mm	PTFE	2	15	100
G8.5									
33650	526018	G8.5	Ceramic	#4 Screw Holes 15mm OC	Terminals	N/A	3	12.6	150
33600	502394	G8.5	Ceramic	#4 Screw Holes 15mm OC	Terminals	N/A	3	5	1000
GX8.5									
34650	547807	GX8.5	LCP	#4 Screw Holes 23mm OC	Terminals	N/A	4	11.9	50
34651	547808	GX8.5	LCP	#4 Screw Holes 23mm OC	Terminals	N/A	4	12.6	50
GY9.5									
37002	534105	GY9.5	Ceramic	#4 Screw Holes 30mm OC	305mm	SF-2	5	62	25
GX10									
31550	543963	GX10	Steatitie	#4 Screw Holes 18mm OC	200mm		7	21.7	100
31550	543153	GX10	Steatitie	#4 Screw Holes 18mm OC	305mm		7	25	100
31400	509356	GX10	PPS	#4 Screw Holes 18mm OC	Terminals	N/A	8	9.2	100
31402	537049	GX10	PPS	#4 Screw Holes 18mm OC	240mm		8	33.9	100
31402	534636	GX10	PPS	#4 Screw Holes 18mm OC	460mm		8	33.9	100
31402	534050	GX10	PPS	#4 Screw Holes 18mm OC	765mm		8	33.9	100
31402	536822	GX10	PPS	#4 Screw Holes 18mm OC	915mm		8	33.9	100
G(X)12									
31921	526251	G12	Ceramic	#8 Screw Holes 30mm OC	765mm	PTFE	9	72	25
31921	529773	G12	Ceramic	#8 Screw Holes 30mm OC	1170mm	PTFE	9	88	25
31936	108257	G12	Ceramic	#8 Screw Holes 30mm OC	460mm	SF-2	10	56	25
31936	525750	G12	Ceramic	#8 Screw Holes 30mm OC	765mm	SF-2	10	72	25
31936	526211	G12	Ceramic	#8 Screw Holes 30mm OC	1524mm	SF-2	10	144	25
42000	509213	G12	LCP	#8 Screw Holes 30mm OC	N/A	N/A	11	20	25
41900	507656	GX12	Ceramic	#8 Screw Holes 30mm OC	300mm	SI	12	58.5	25
K12s-7									
21100	107652	K12s-7	Ceramic	N/A - Socket Only	Terminals	N/A	13	25	25
21100	107677	K12s-7	Ceramic	#10 Screw Holes 61.4mm OC	Terminals	N/A	13	70	25
PGJ5									
34155	538630	PGJ5	Ceramic	#4 Screw Holes 11.6mm OC	460mm	PTFE - Lat	14	21.7	100
34116	534102	PGJ5	Ceramic	#4 Screw Holes 11.6mm OC	305mm	PTFE - Cent	15	11.5	100
34116	537057	PGJ5	Ceramic	#4 Screw Holes 11.6mm OC	460mm	PTFE - Cent	15	18.6	100
34116	537784	PGJ5	Ceramic	#4 Screw Holes 11.6mm OC	765mm	PTFE - Cent	15	27.8	100
34125	537454	PGJ5	Ceramic	#4 Screw Holes 11.6mm OC	200mm	PTFE - Lat	16	10.5	100
34125	535782	PGJ5	Ceramic	#4 Screw Holes 11.6mm OC	305mm	PTFE - Lat	16	12.5	100
34125	542304	PGJ5	Ceramic	#4 Screw Holes 11.6mm OC	460mm	PTFE - Lat	16	14.5	100
RX7s									
30608	108913	RX7s	Ceramic	#8 Screw Holes 34mm OC	460mm	PTFE	17	72	25
30611	100732	RX7s	Ceramic	#8 Screw Holes 34mm OC	305mm	SF-2	17	68	25
31662	107065	RX7s	PPT	#8 Screw Holes 34mm OC	300mm	SI	18	23	25
32301	506216	RX7s	Ceramic	Captive mounting for #8 Screw	360mm	SF-2	19	34	300
32330	100928	RX7s	Ceramic	Central tapped hole for #8 Screw	300mm	SI	19	75	200

LAMP HOLDERS

Type	Reference Number	Lamp Type	Material	Mounting	Lead Length	Lead Material	Drawing	Weight	Unit Pcs.
E26									
62609	109459	E26	Porcelain	#8 Screw Holes 18mm OC	Terminals	N/A	20	64	200
62610	525523	E26	Porcelain	Bushings for #8 Screw 18mm OC	Terminals	N/A	20	64	200
62030	102597	E26	Porcelain	#8 Screw Holes 18mm OC	Terminals	N/A	21	61	200
64707	504262	E26	PET - White	ST #7 Screws 18mm OC	Terminals	N/A	22	15.4	500
64707	506381	E26	PET - Black	ST #7 Screws 18mm OC	Terminals	N/A	22	15.4	500
E39									
12870	109014	E39	Porcelain	Bushings 35mm OC	Terminals	N/A	23	190	50
12876	109518	E39 w/grip	Porcelain	Bushings 35mm OC	Terminals	N/A	23	190	50
12850	108851	E39	Porcelain	#10 Screw Holes 30mm OC	Terminals	N/A	24	208	50
12851	109272	E39 w/grip	Porcelain	#10 Screw Holes 30mm OC	Terminals	N/A	24	208	50
12860	108869	E39	Porcelain	Bracket for #10 Screws 56.5mm OC	Terminals	N/A	25	219	50
12861	109460	E39 w/grip	Porcelain	Bracket for #10 Screws 56.5mm OC	Terminals	N/A	25	219	50
12862	108870	E39 w/grip	Porcelain	Bracket for #10 ST Screws 56.5mm OC	Terminals	N/A	26	227	50
12650	501981	E39	PPS	#10 Screw Holes 30mm OC	Terminals	N/A	27	109	50
12660	501982	E39	PPS	Bracket for #10 Screws 56.5mm OC	Terminals	N/A	28	119	50

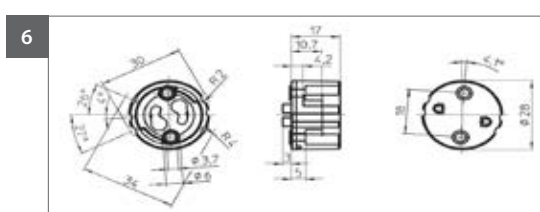
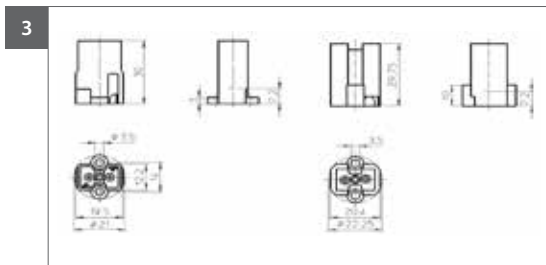
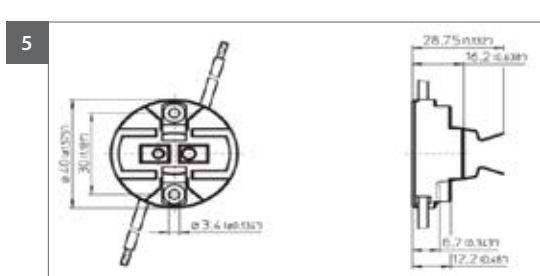
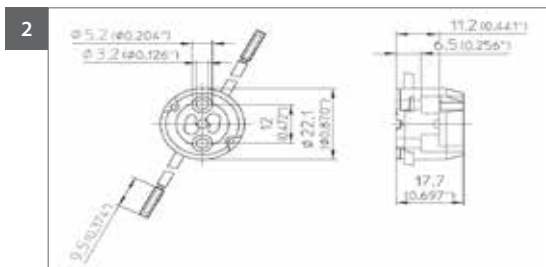
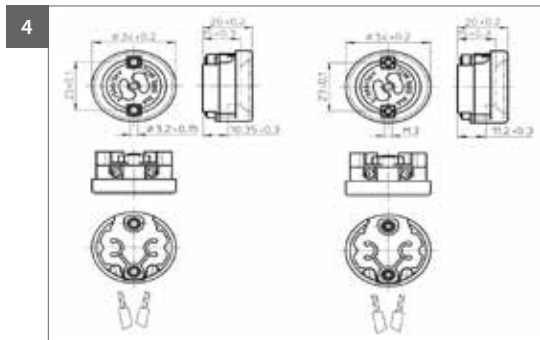
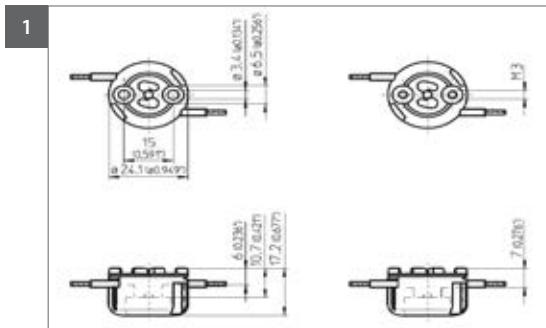

LAMP HOLDERS

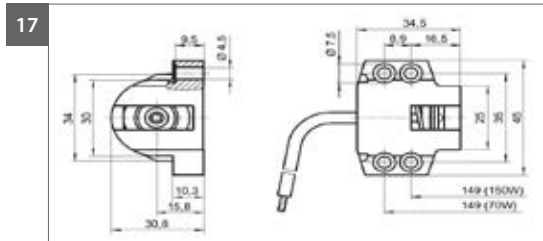
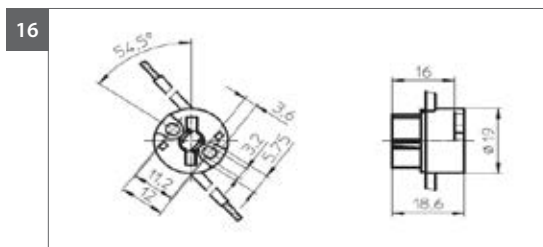
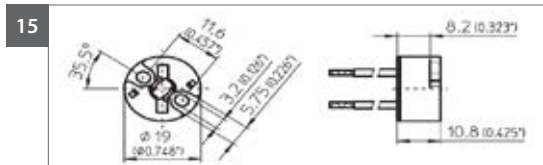
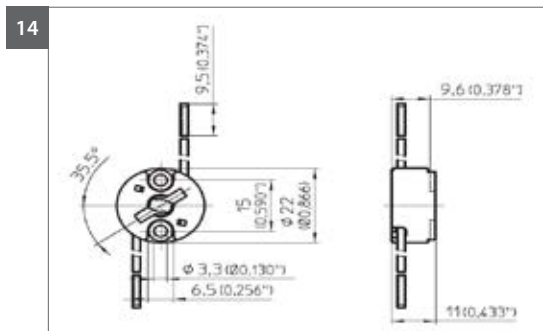
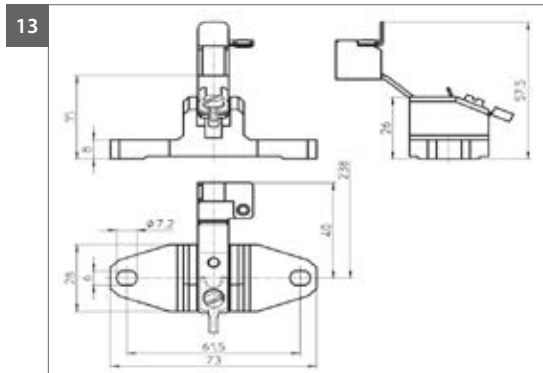
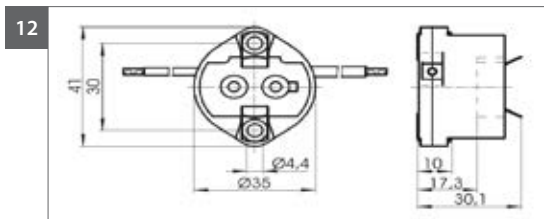
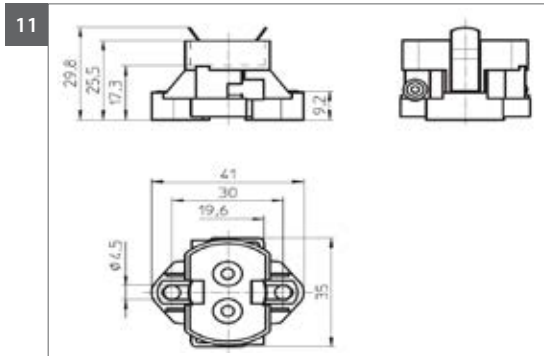
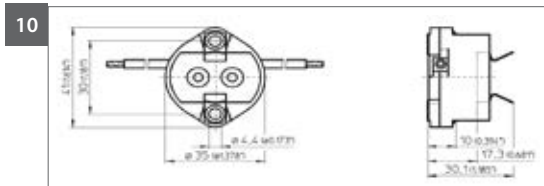
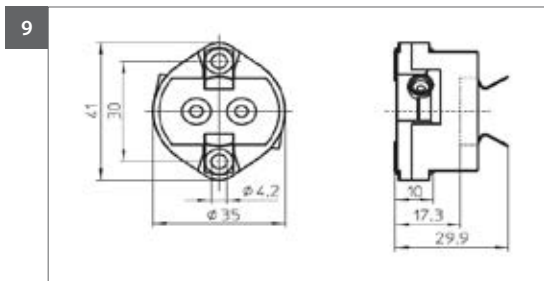
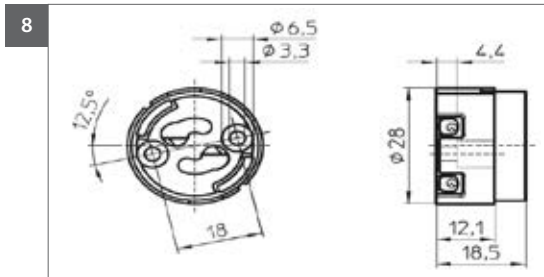
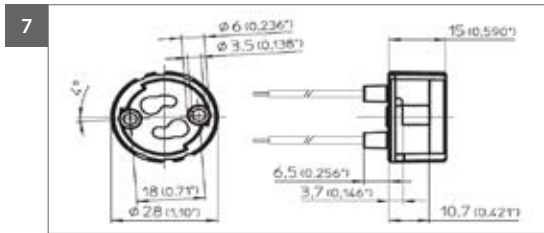

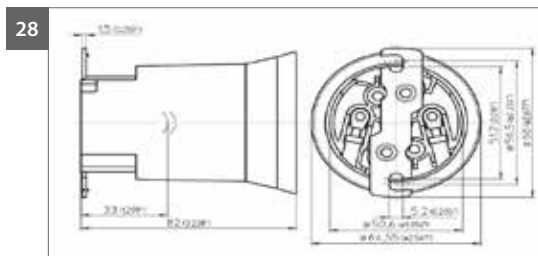
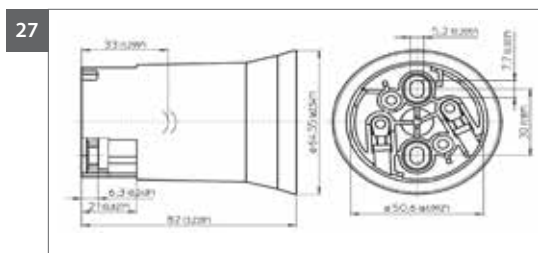
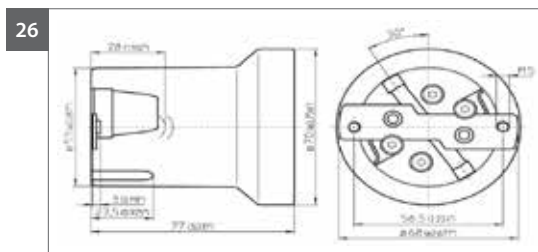
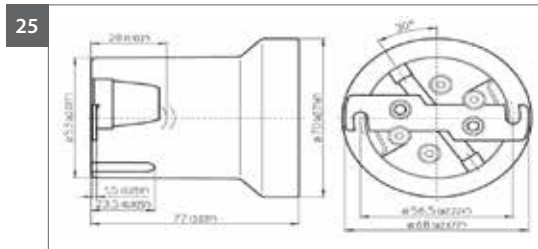
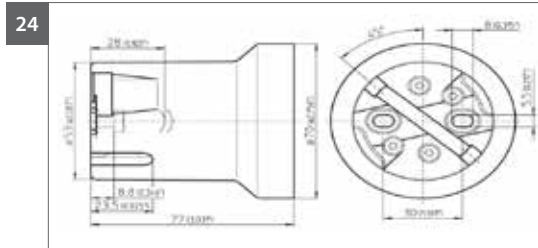
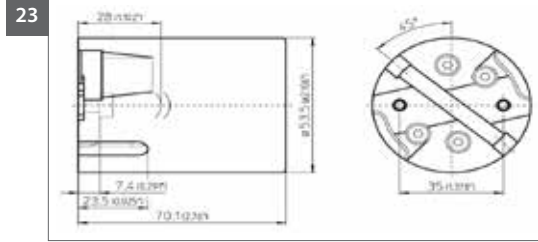
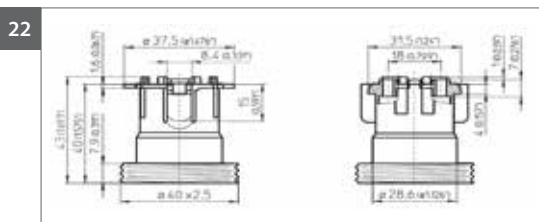
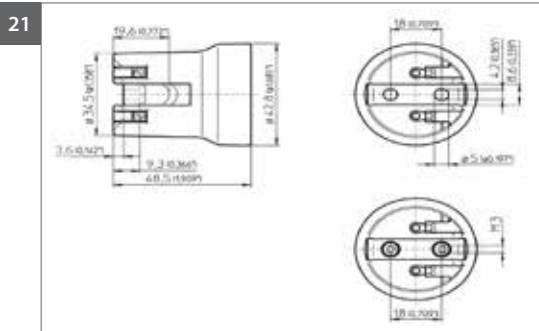
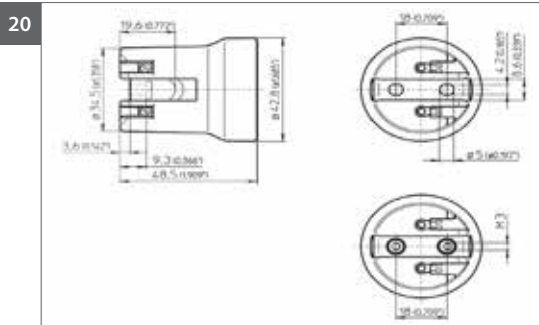
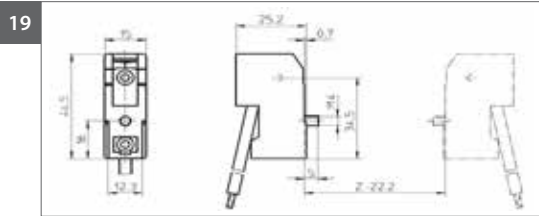
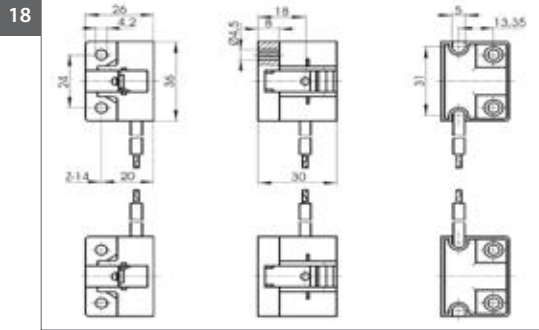

B15d, G(Z)4 G(X)5.3 G(Y)6.35, G(Z)4, G9, G53, GU4 Lampholders

HALOGEN

Type	Reference Number	Lamp Type	Material	Mounting	Lead Length	Lead Material	Drawing	Weight	Unit Pcs.
B15d									
48101	108925	B(A)15d	Steel/Ceramic	#4 Screw Holes 25.5mm OC	Terminals	w/ground	1	16	500
48102	102927	B(A)15d	Steel/Ceramic	#4 Screw Holes 25.5mm OC	Terminals	N/A	2	17	500
78103	102929	B(A)15d	Steel/Ceramic	#4 Screw Holes 25.5mm OC	Terminals	w/ground	2	18	500
G(Z)4 G(X)5.3 G(Y)6.35									
32400	109855	G4/G5.3/G6.35	Ceramic	#4 Screw Holes 11.5mm OC	152mm	PTFE	3	8.1	1000
32400	536857	G4/G5.3/G6.35	Ceramic	#4 Screw Holes 11.5mm OC	200mm	PTFE	3	8.3	1000
32400	109856	G4/G5.3/G6.35	Ceramic	#4 Screw Holes 11.5mm OC	300mm	PTFE	3	8.5	1000
32400	525681	G4/G5.3/G6.35	Ceramic	#4 Screw Holes 11.5mm OC	665mm	PTFE	3	8.8	1000
32400	100946	G4/G5.3/G6.35	Ceramic	#4 Screw Holes 11.5mm OC	750mm	PTFE	3	9	1000
32480	504542	G4/G5.3/G6.35	Ceramic	#4 Screw Holes 11.5mm OC	300mm	PTFE	4	8.8	1000
32700	109851	G4/G5.3/G6.35	Ceramic	#4 Screw Holes 11.4mm OC	155mm	PTFE	5	12.8	1000
32700	109852	G4/G5.3/G6.35	Ceramic	#4 Screw Holes 11.4mm OC	305mm	PTFE	5	12.8	1000
32700	109853	G4/G5.3/G6.35	Ceramic	#4 Screw Holes 11.4mm OC	590mm	PTFE	5	12.8	500
32720	525857	G4/G5.3/G6.35	Ceramic	#4 Screw Holes 26mm OC	320mm	PTFE	6	8.7	1000
32720	529699	G4/G5.3/G6.35	Ceramic	#4 Screw Holes 26mm OC	960mm	PTFE	6	8.7	1000
G(Z)4									
30449	530250	G(Z)4	PPS	#4 Screw Holes 20mm OC	140mm	PTFE	7	3.8	1000
60464	108892	G(Z)4	PPS	N/A	Terminals	N/A	9	2.2	1000
60469	108893	G(Z)4	PPS	N/A	Terminals	N/A	10	1.9	1000
32500	101035	G(Z)4	PPS	#4 Screw Holes 12mm OC	140mm	PTFE	11	8.7	500
32500	509069	G(Z)4	PPS	#4 Screw Holes 12mm OC	195mm	PTFE	11	8.9	500
32500	509035	G(Z)4	PPS	#4 Screw Holes 12mm OC	765mm	PTFE	11	9.8	500
G9									
33710	508306	G9	LCP	20.8x2 Ext, #3 Holes 14mm OC	Terminals	N/A	12	6	1000
33711	520728	G9	LCP	20.8x2 Ext, #4 Holes 23mm OC	Terminals	N/A	13	8.7	1000
33721	508610	G9	Ceramic	20.8x2 Ext, #4 Holes 23mm OC	Terminals	N/A	13	10.6	1000
33721	508611	G9	Ceramic	20.8x2 Ext, #4 Holes 23mm OC	Terminals	N/A	13	10.2	1000
33800	509357	G9	Ceramic/LCP	N/A	Terminals	N/A	14	7.5	1000
33900	534132	G9	Ceramic	N/A	140mm	PTFE	15	14.2	1000
33500	502004	G9	Ceramic	#4 Screw Holes 17mm OC	Terminals	N/A	16	16	1000
G53									
33100	107694	G53	PPS	#8 Screw Holes	140mm	PTFE	17	3.8	1000
GU4									
32400	109855	GU4	Ceramic	#4 Screw Holes 11.5mm OC	152mm	PTFE	18	8.1	1000
32400	109856	GU4	Ceramic	#4 Screw Holes 11.5mm OC	300mm	PTFE	18	8.1	1000
32400	525681	GU4	Ceramic	#4 Screw Holes 11.5mm OC	665mm	PTFE	18	8.1	1000
32400	536857	GU4	Ceramic	#4 Screw Holes 11.5mm OC	200mm	PTFE	18	8.1	1000
32412	538286	GU4	Ceramic		460mm	PTFE	18	8.1	1000
32480	504542	GU4	Ceramic	#4 Screw Holes 11.5mm OC	300mm	PTFE	19	8.8	1000
32700	109851	GU4	Ceramic	#4 Screw Holes 11.4mm OC	155mm	PTFE	20	12.8	1000
32700	109852	GU4	Ceramic	#4 Screw Holes 11.4mm OC	305mm	PTFE	20	12.8	1000
32700	109853	GU4	Ceramic	#4 Screw Holes 11.4mm OC	590mm	PTFE	20	12.8	1000
32720	525857	GU4	Ceramic	#4 Screw Holes 26mm OC	320mm	PTFE	21	8.7	1000
32720	529699	GU4	Ceramic	#4 Screw Holes 26mm OC	960mm	PTFE	21	8.7	1000

LAMP HOLDERS

Type	Reference Number	Lamp Type	Material	Mounting	Lead Length	Lead Material	Drawing	Weight	Unit Pcs.
GU5.3									
32480	106457	GU5.3	Ceramic	#4 Screw Holes 11.5mm OC	140mm	PTFE	22	8.8	1000
32480	504542	GU5.3	Ceramic	#4 Screw Holes 11.5mm OC	300mm	PTFE	22	9.1	1000
32680	101248	GU5.3	Ceramic	#4 Screw Holes 12mm OC	140mm	PTFE	23	11	500
32690	536856	GU5.3	Ceramic	#4 Screw Holes 12mm OC	140mm	PTFE	23	12	500
33300	109547	GU5.3	LCP	#4 Screw Holes 11.5mm OC	Terminals	N/A	24	2.2	1000
32400	109855	GU5.3	Ceramic	#4 Screw Holes 11.5mm OC	140mm	PTFE	25	8.1	1000
GU10/GZ10									
31000	108979	GU10/GZ10	LCP	#4 Screw Holes 18mm OC	Terminals	N/A	26	7	1000
R7s									
30543	109450	R7s	Al	#4 Screw Holes 28mm OC	350mm	PTFE	27	16.7	1000
30550	100720	R7s	Al	#4 Screw Holes 28mm OC	350mm	PTFE	27	16.7	1000
30541	108756	R7s	Al	#4 Screw Holes 28mm OC	320mm	PTFE	27	16.5	1000
32300	100912	R7s	Ceramic	#8 Screw Holes 65mm OC	200mm	PTFE	28	25	400
32310	400036	R7s	Ceramic	#8 Screw Holes 65mm OC	350mm	PTFE	29	72	200
32310	107195	R7s	Ceramic	#8 Screw Holes 65mm OC	200mm	PTFE	29	72	200
32320	400080	R7s	Ceramic	#8 Screw Holes 65mm OC	114mm	PTFE	30	77	200

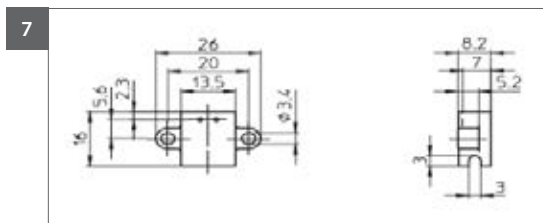
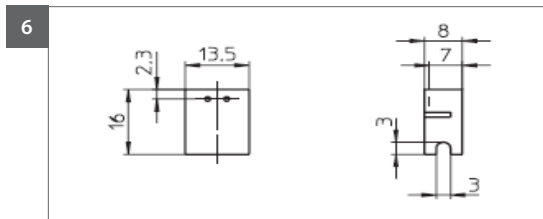
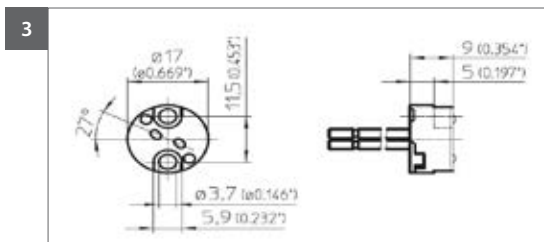
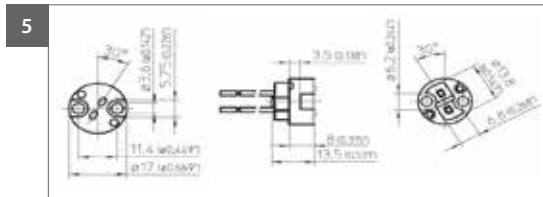
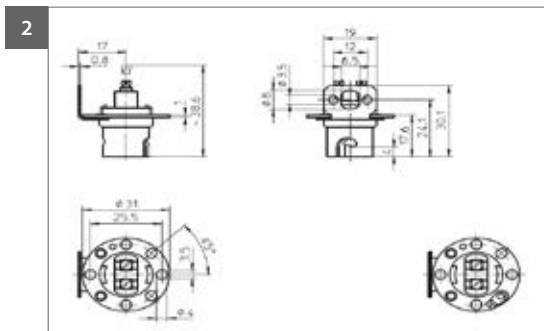
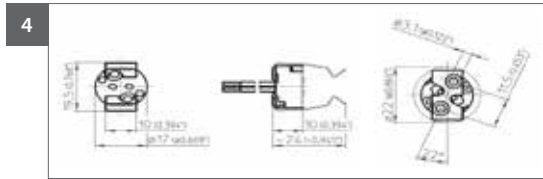
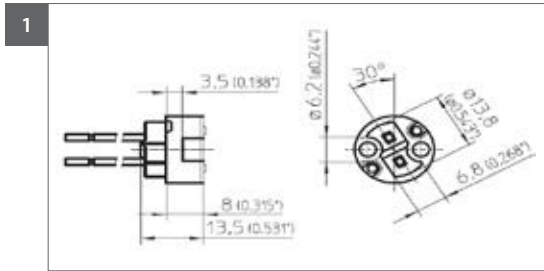

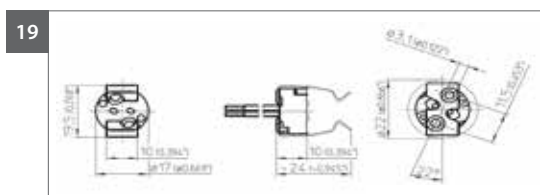
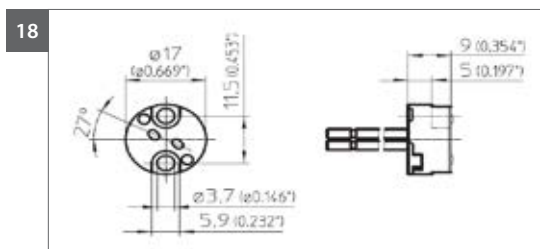
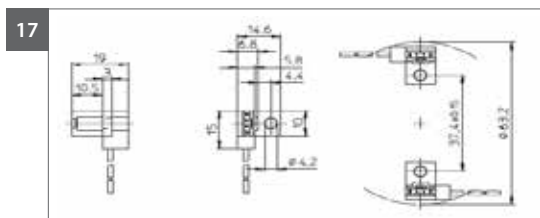
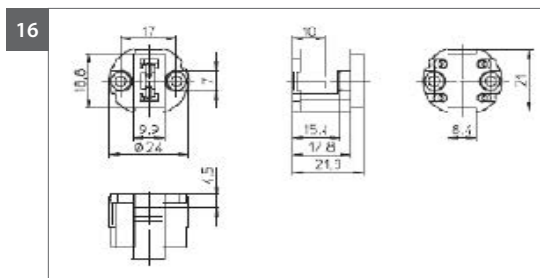
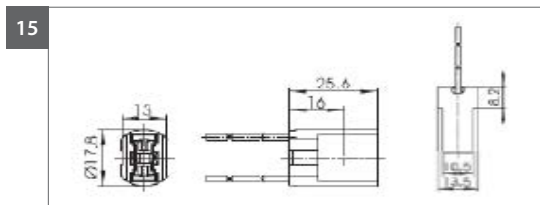
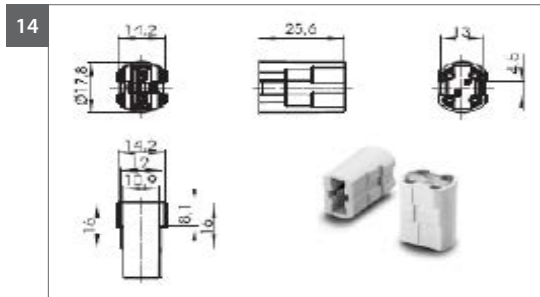
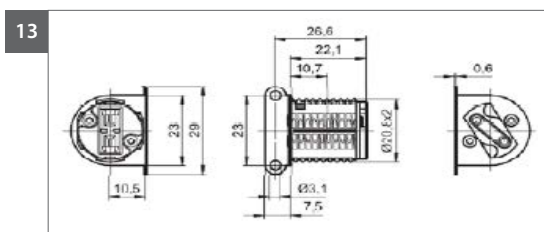
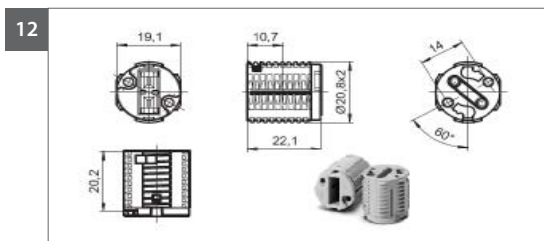
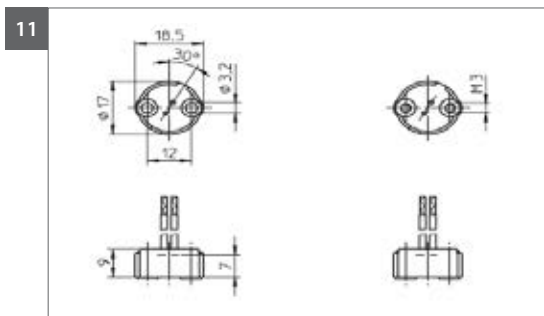
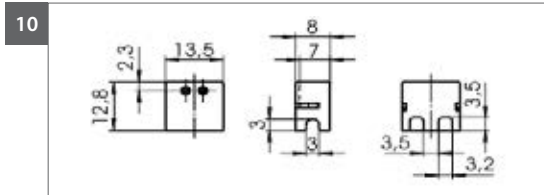
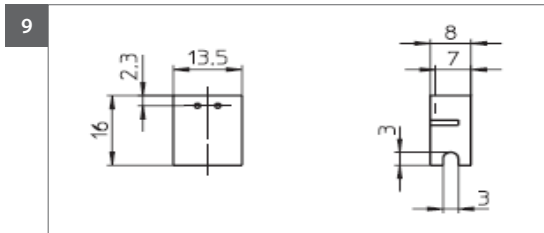

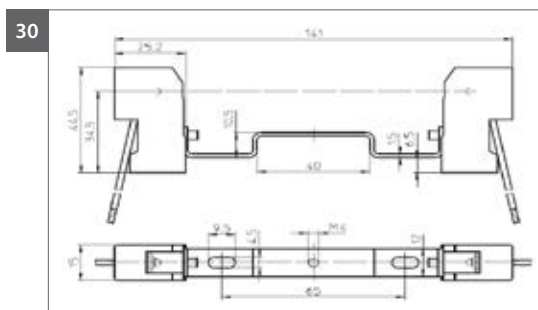
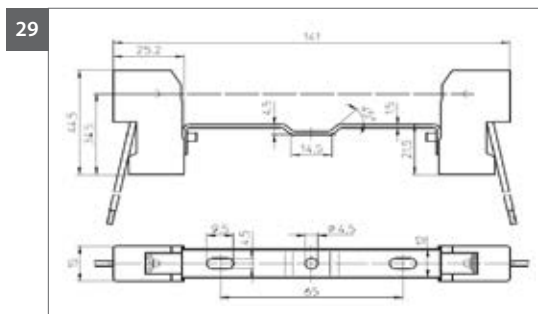
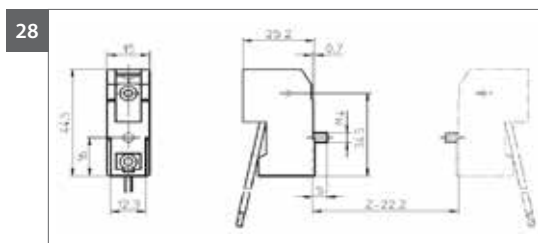
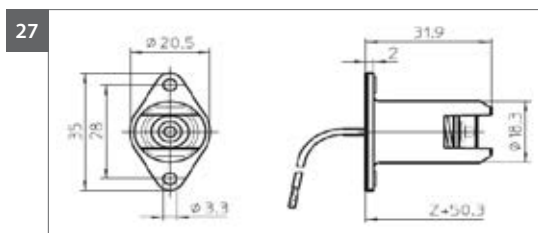
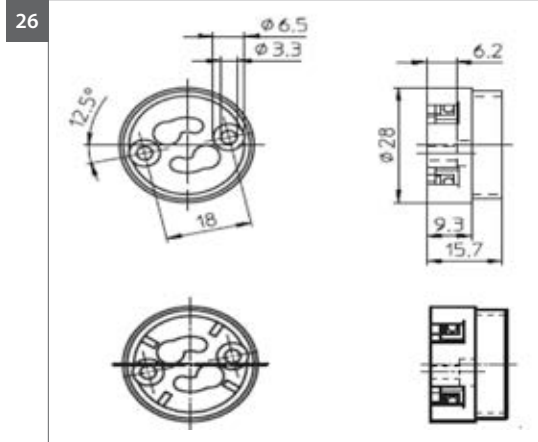
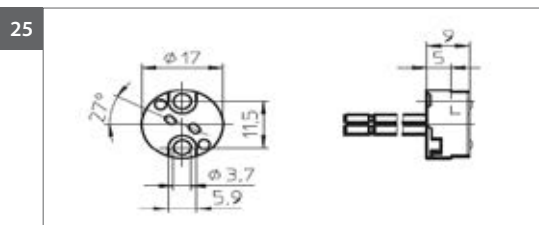
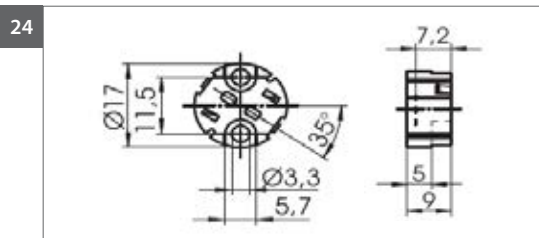
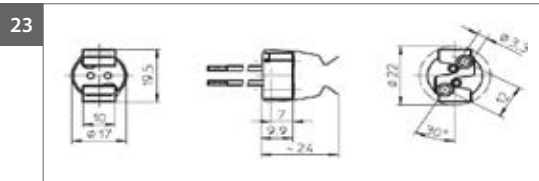
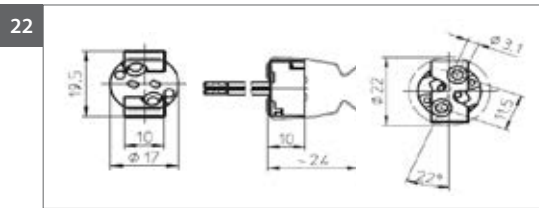
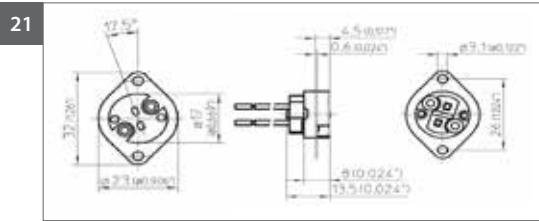
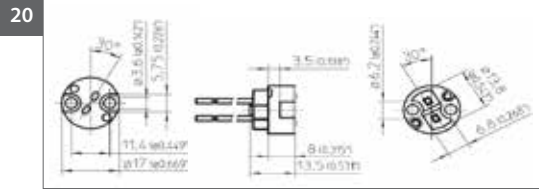

2G7, 2GX7, 2G8, 2G10, 2G11, G(X)24, G(X)24 Rotary Lock Lampholders

CFL

Type	Reference Number	Lamp Type	Material	Mounting	Lead Orientation	Misc	Drawing	Weight	Unit Pcs.
2G7									
35613	500574	2G7	PBT	10 x 20 Snap-In	Horizontal	-	1	18	500
35610	109235	2G7	PBT	10 x 20 Snap-In / #4 Screw Holes	Horizontal	-	2	15	500
35611	109238	2G7	PBT	#8 Screw Holes 24mm OC	Horizontal	-	3	17	500
35612	109240	2G7	PBT	#4 Screw Holes for Rear Mount	Horizontal	-	4	14	500
2GX7									
35613	500575	2GX7	PBT	10 x 20 Snap-In	Horizontal	-	1	17	500
35620	109237	2GX7	PBT	10 x 20 Snap-In / #4 Screw Holes	Horizontal	-	2	15	500
35621	109239	2GX7	PBT	#8 Screw Holes 24mm OC	Horizontal	-	3	17	500
35622	109241	2GX7	PBT	#4 Screw Holes for Rear Mount	Horizontal	-	4	14	500
2G8									
59000	526755	2G8	PBT	#4 Screw Holes	-	-	5	19.6	250
2G10									
36300	101521	2G10	PBT	#4 Screw Holes 24mm OC	Horizontal	-	6	25.5	250
2G11									
36051	101489	2G11	PBT	Lateral Pivot Brackets	Horizontal	-	7	14	500
36051	532687	2G11	PBT	Lateral Pivot Brackets	Horizontal	Shunted	7	14	500
36050	101485	2G11	PBT	Lateral #8 Screw Holes 24mm OC	Horizontal	-	8	14	500
36050	532685	2G11	PBT	Lateral #8 Screw Holes 24mm OC	Horizontal	Shunted	8	14	500
36052	101491	2G11	PBT	13.3 x 25.5 Snap-In	Vertical	-	9	14	500
36052	532689	2G11	PBT	13.3 x 25.5 Snap-In	Vertical	Shunted	9	14	500
36053	101493	2G11	PBT	13.3 x 25.5 Snap-In	Horizontal	-	10	14	500
36053	532691	2G11	PBT	13.3 x 25.5 Snap-In	Horizontal	Shunted	10	14	500
G(X)24									
71211	527560	G(X)24q-1	PBT	4X #4 Screw Holes 20.6mm OC	Vertical	10/13W	11	12.9	500
71212	527561	G(X)24q-2	PBT	4X #4 Screw Holes 20.6mm OC	Vertical	18W	11	12.9	500
71219	527566	G(X)24q-3/4	PBT	4X #4 Screw Holes 20.6mm OC	Vertical	26/32/42W	11	12.9	500
71215	527564	G(X)24q-5	PBT	4X #4 Screw Holes 20.6mm OC	Vertical	57W	11	13.5	500
71216	527565	G(X)24q-6	PBT	4X #4 Screw Holes 20.6mm OC	Vertical	70W	11	13.5	500
72111	528120	G(X)24q-1	PBT	4.5mm W Split pins spaced 34.5mm	Vertical	10/13W	12	11.9	500
72112	528121	G(X)24q-2	PBT	4.5mm W Split pins spaced 34.5mm	Vertical	18W	12	11.9	500
72119	528126	G(X)24q-3/4	PBT	4.5mm W Split pins spaced 34.5mm	Vertical	26/32/42W	12	11.9	500
72115	528124	G(X)24q-5	PBT	4.5mm W Split pins spaced 34.5mm	Vertical	57W	12	12.5	500
72116	528125	G(X)24q-6	PBT	4.5mm W Split pins spaced 34.5mm	Vertical	70W	12	12.5	500
71311	527589	G(X)24q-1	PBT	10x20 snap-in Foot	Horizontal	10/13W	13	12	500
71312	527590	G(X)24q-2	PBT	10x20 snap-in Foot	Horizontal	18W	13	12	500
71319	527596	G(X)24q-3/4	PBT	10x20 snap-in Foot	Horizontal	26/32/42W	13	12	500
71315	527594	G(X)24q-5	PBT	10x20 snap-in Foot	Horizontal	57W	13	12.6	500
71316	527595	G(X)24q-6	PBT	10x20 snap-in Foot	Horizontal	70W	13	12.6	500
71711	527794	G(X)24q-1	PBT	#8 Screw Holes 24mm OC	Horizontal	10/13W	14	15.2	500
71712	527795	G(X)24q-2	PBT	#8 Screw Holes 24mm OC	Horizontal	18W	14	15.2	500
71719	527800	G(X)24q-3/4	PBT	#8 Screw Holes 24mm OC	Horizontal	26/32/42W	14	15.2	500
71715	527798	G(X)24q-5	PBT	#8 Screw Holes 24mm OC	Horizontal	57W	14	15.8	500
71716	527799	G(X)24q-6	PBT	#8 Screw Holes 24mm OC	Horizontal	70W	14	15.8	500
G(X)24 Rotary Lock									
45940	507993	G(X)24q-2	PBT	#4 Screw Holes 28.8mm OC	Vertical	18W	15	20.2	500
45960	507994	G(X)24q-3	PBT	#4 Screw Holes 28.8mm OC	Vertical	26/32W	15	20.2	500
45930	507992	G(X)24q-3/4	PBT	#4 Screw Holes 28.8mm OC	Vertical	26/32/42W	15	20.2	500
45980	507995	G(X)24q-4	PBT	#4 Screw Holes 28.8mm OC	Vertical	42W	15	20.2	500

LAMP HOLDERS

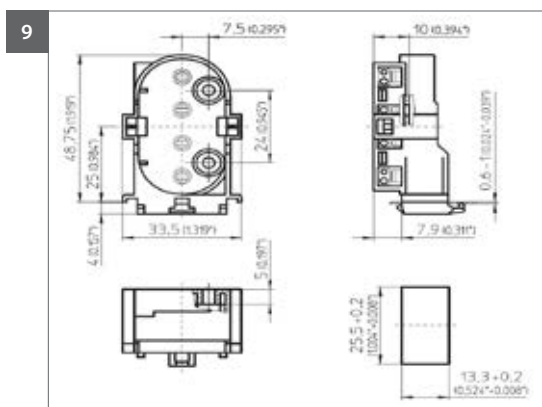
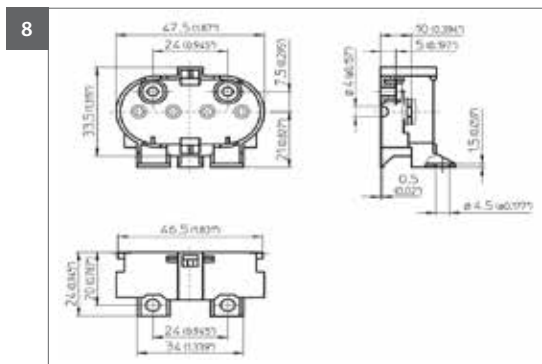
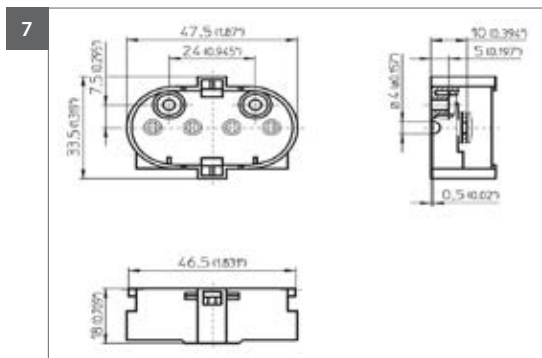
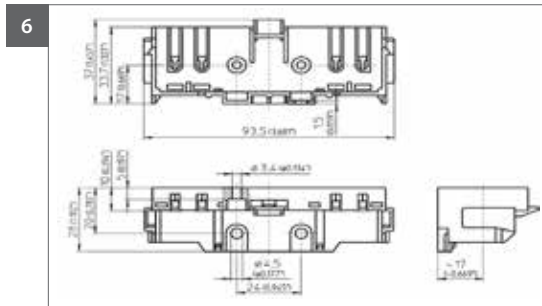
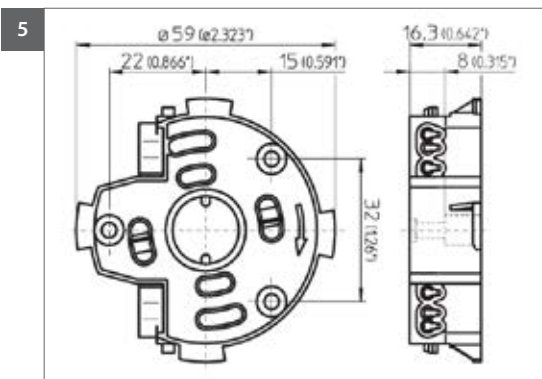
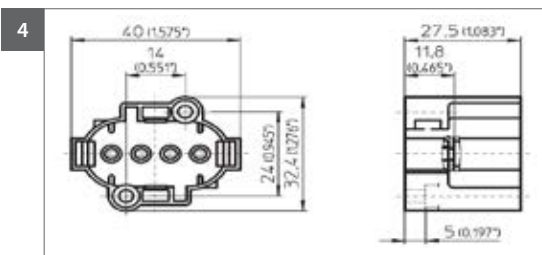
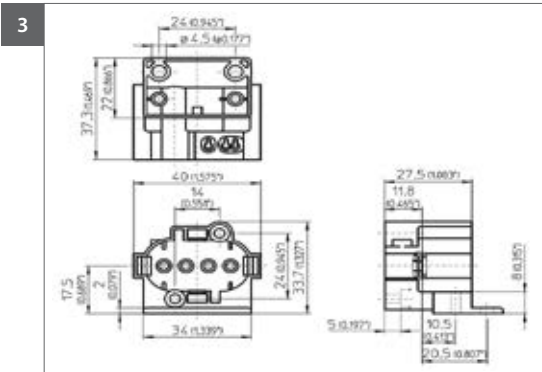
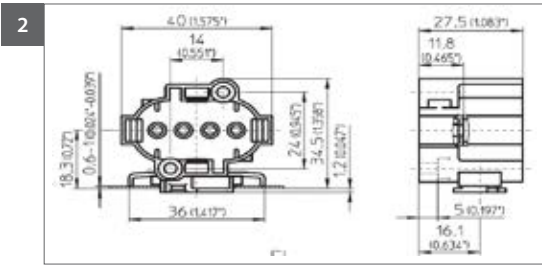
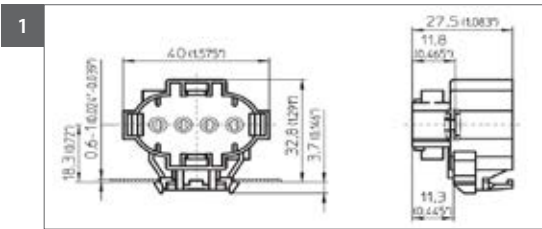

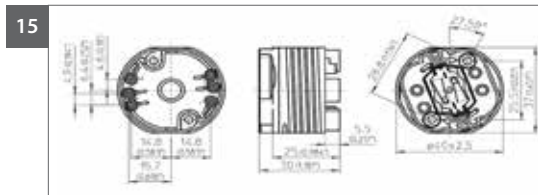
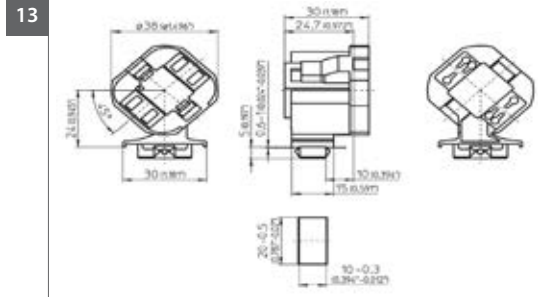
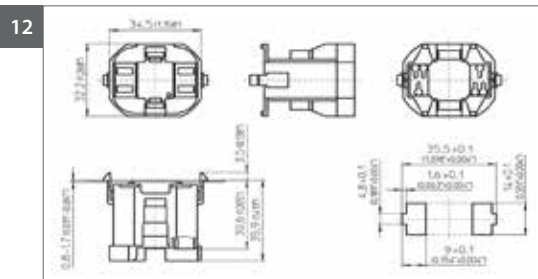
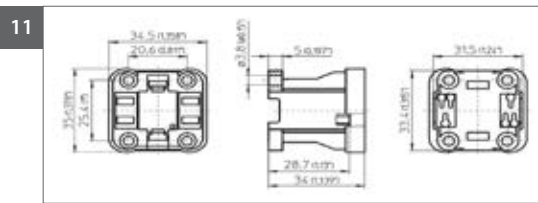
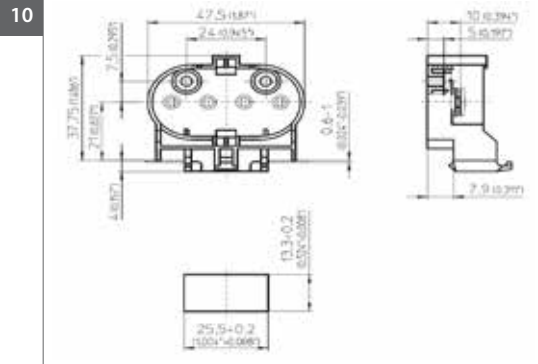

Sign Illuminating Ballasts

A Complete Range Of Solutions... From The Name You Trust

Universal Lighting Technologies ("Universal") is known throughout the sign business as a company that can set and meet today's toughest industry standards. Our high-output ballasts are great for rugged outdoor sign cabinet applications because they provide ultra-reliable, low-temperature starting as low as -20° F. All Universal sign ballasts offer Class P thermal protection.

- Signa® Electronic Sign ballasts are ideal for new sign installations with minimum wire connections, universal input voltage, parallel lamp operation, and maximum energy savings.
- Signa® Electronic Sign ballasts, when paired with our wiring blocks, offer the perfect solution for magnetic to electronic sign cabinet retrofits.

Universal offers the convenience of one-stop shopping for not just sign ballasts, but compact fluorescent, linear fluorescent, HID, and all your other ballast needs.

For the unmistakable sign of quality and reliability, turn to Universal.



Universal® sign ballasts provide ultra-reliable low-temperature starting — plus Class P thermal protection.

Application And Operating Information

Heat

Ballasts generate heat during normal operation. By design, fluorescent ballasts should operate so that their maximum hot-spot case temperature does not exceed 80°C (176°F).

Operating at higher temperatures will shorten ballast life or may cause the thermal protection circuit to trip.

The temperature the ballast reaches depends on the temperature of the area surrounding it — plus the heat-conducting surface touching the ballast. Ballasts should be installed in a manner that avoids future overheating. To maintain normal ballast temperature, you should:

1. Mount the ballast against a flat surface of heavy gauge metal such as the structural part of the sign.
2. Keep the ballast as far away as possible from other ballasts, lamps or reflective surfaces. (Lamps generate approximately three-fourths of the heat in a plastic sign.) The ends of the lamps are the hottest part, so you should mount the ballast as far away from the ends as possible.
3. Paint the inside of the sign with flat white paint.

Moisture Protection

1. Vent the sign as well as possible without allowing water to enter.
2. Ballasts should be mounted horizontally (except for weatherproof types). If the ballast must be mounted vertically, allow room for sufficient air circulation. Wherever possible, mount the ballast in an enclosure outside the sign by using Universal pup tents. You can get pup tents when you order the plastic sign ballast. Your wholesaler will also have a supply for your convenience.

Grounding

The white lead of a ballast must be connected to the neutral or ground side of the power supply. All metal parts of the sign, as well as the ballast case, must be grounded either through the conduit which holds the power supply or by direct connection with a grounding wire. An ungrounded sign is a potential hazard—and it can give misleading symptoms when looking for sign faults.

Light Output vs. Temperature

The light output of a fluorescent lamp varies according to the mercury vapor pressure inside the lamp. This pressure is controlled by the coldest spot on the bulb wall. The ballast may start the lamp, but the light output can be very low if the bulb wall temperature is low. Several factors influence this, including ambient temperatures, wind, type of enclosure, etc. If maximum light output is critical, consult a lamp manufacturer for advice.

Lamp Starting Problems

Occasionally a field problem will arise involving improper lamp starting. The usual complaint is that the lamps start slowly (or not at all). Here are some of the causes:

1. Low line voltage
2. Improper sign grounding
3. Insufficient or no open circuit voltage
4. Dirty lamps during high-humidity operating conditions
5. Lamps improperly inserted in the sockets

If lamp starting is a problem in your installation, check the sign grounding and open circuit voltage. If both are normal, the probable cause is dirty lamps. The lamps should be washed in clean water, drip-dried, and reinstalled. If this doesn't solve the problem, contact your nearest Universal representative for further assistance.

Short Lamp Life

If the lamp has not given proper length of service as specified by the lamp manufacturer, the following reasons for early failure should be considered:

1. Frequent starting and short operating periods
2. Improper ballast
3. Improper voltage supply
4. Faulty wiring
5. Defective lamps
6. Lamps improperly inserted in sockets

Early lamp failure will be preceded by a dense blackening on either or both ends of the lamps. This blackening will extend three or four inches from the lamp base and should not be confused with a small dense spot, which is a mercury deposit that can occur any time during lamp life. Dense blackening due to early lamp failure should not be confused with the gray bands that sometimes appear toward the end of normal lamp life (about two inches from either end of the lamp).

Sign Ballast Footage Chart

ELECTRONIC SIGN BALLASTS																						T12HO Lamps		
No. of Lamps Per Ballasts	TOTAL FOOTAGE FOR T12HO & T8HO LAMPS																				T8HO Lamps			
	2	4	6	8	10	12	14	16	18	20	22	24	26	28	30	32	34	36	38	40	42	44	46	48
1-2	ESB-216-12 (Up to 8' Lamps)																							
	ESB-216-12 (Up to 6' Lamps)																							
1-4	ESB-432-14 (Up to 8' Lamps)																							
	ESB-432-14 (Up to 6' Lamps)																							
4-6	ESB-848-46 (Up to 8' Lamps)																							
	ESB-848-46 (Up to 6' Lamps)																							
1-4	ESB-1040-14 (Up to 10' Lamps)																							
	ESB-1040-14 (Up to 8' Lamps)																							

PLASTIC SIGN BALLAST LEAD LENGTHS (INCHES)				
CATALOG NUMBER	WHITE	BLACK	BLUES	REDS
SIGNA ELECTRONIC SIGN BALLASTS - T8 & T12 HIGH OUTPUT LAMPS - 108-35 Volts - 50-60 Hz				
SIX LAMP BALLASTS				
ESB216-12	24	24	120	120
ESB432-14	24	24	120	120
ESB848-46	24	24	120	120
ESB1040-46	24	24	120	120

Note: Maximum volts above ground, any lead 590 volts.

- Instant start for maximum energy savings
- Simplified wiring for fewer connections
- Universal input voltage
- Parallel Lamp Operation

PLASTIC SIGN BALLAST LEAD LENGTHS (INCHES)								
CATALOG NUMBER	TOTAL LAMP FOOTAGE	START TEMP (°F)	INPUT VOLTAGE	MAX. INPUT VOLTAGE	MAX. LINE CURRENT (A)	WIRING DIAGRAM	DIMENSION CHART REF.	WEIGHT (LBS.)
T12HO UP TO 8' IN LENGTH OR T8HO UP TO 6' IN LENGTH - 120 to 277 Volts - 50/60 Hz								
ONE TO TWO LAMP BALLASTS								
ESB216-12	2' min. – 16' max.	-20	120	134	1.12	1	1	4.2
			277	130	0.47			
ONE, TWO, THREE OR FOUR LAMP BALLASTS								
ESB432-14	4' min. – 32' max.	-20	120	280	2.34	2	2	7.4
			277	274	0.99			
FOUR, FIVE OR SIX LAMP BALLASTS								
ESB848-46	8' min. – 48' max.	-20	120	408	3.41	3	3	9.7
			277	395	1.47			
T12HO UP TO 10' IN LENGTH OR T8HO UP TO 8' IN LENGTH - 120 to 277 Volts - 50/60 Hz								
ONE, TWO, THREE OR FOUR LAMP BALLASTS								
ESB1040-14	10' min. – 40' max.	-20	120	341	2.85	2	3	10
			277	331	1.25			

Consult www.signasign.com for complete specification information

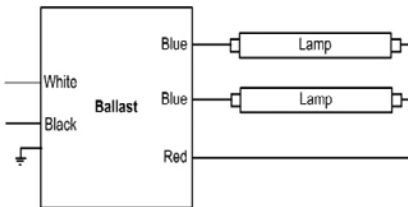

Diagram 1

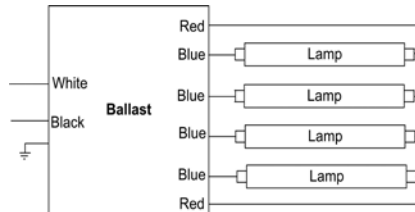

Diagram 2

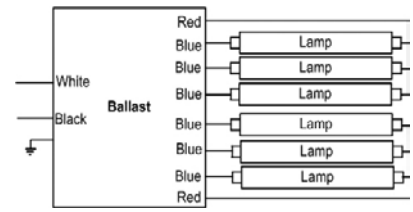
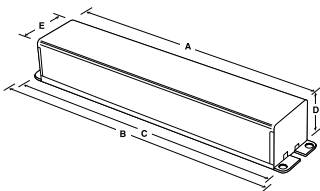

Diagram 3



ELECTRONIC SIGN BALLASTS DIMENSION CHART - STANDARD CASE (INCHES)

Ref. #	A	B	C	D	E
1	10 ^{37/64}	11 ^{45/64}	11 ^{9/64}	1 ^{3/4}	3 ^{3/16}
2	13 ^{3/16}	14 ^{5/16}	13 ^{3/4}	2 ^{43/64}	3 ^{3/16}
3	15 ^{9/16}	16 ^{11/16}	16 ^{1/8}	2 ^{43/64}	3 ^{3/16}

Diagrams Notes:

When Operating less than the maximum number of lamps, insulate unused blue leads.

SIGNA WIRE BLOCK

For use converting magnetic ballast installations to electronic systems.

CATALOG NUMBER	MAGNETIC BALLASTS	NUMBER OF LAMPS OPERATED	FOR USE WITH:
WB66	6 Lamps	6 Lamps	ESB848-46
WB65	6 Lamps	5 Lamps	ESB848-46
WB64	6 Lamps	4 Lamps	ESB848-46
WB44	4 Lamps	4 Lamps	ESB432-14 / ESB1040-14
WBEXT – 24" wiring harness for extending magnetic ballast leads.			

PHYSICAL PROPERTIES	
LENGTH	6.00 in (152.4 mm)
WIDTH	3.00 in (76.2 mm)
HEIGHT	0.75 in (19.05 mm)
WEIGHT	0.06 lbs.

Notes

Glossary

ANSI (American National Standards Institute): Non-profit organization that generates voluntary product performance standards for many U.S. industries. ANSI Standard C82.11 applies to high frequency fluorescent lamp ballasts.

Arc: Intense luminous discharge formed by the passage of electric current across a space between electrodes.

Auto Reset Shutdown Circuit: Circuit senses lamp end of life and will automatically shut off power to the lamp(s). When a new lamp is inserted in the socket, the ballast resets, and turns on the lamp automatically.

Ballast Efficacy Factor (BEF): Value used to evaluate various lighting systems based on light output and power input. The BEF can only be used to compare systems operating the same type and quantity of lamps.

Ballast Factor (BF): Measure of light output from lamp operated by commercial ballast as compared to a laboratory standard reference ballast. Ballast factor .94 means ballast produces 94% of light produced by ANSI C82.2 reference ballast operating same lamps.

Ballast Luminous Efficiency (BLE): New ballast efficiency metric introduced by DOE. Equal to the ratio of total lamp arc power to ballast input power.



Canadian Energy Standards: Indicates ballast complies with Canadian Energy Standards and meets the requirements of CAN/CSA-C654-M91.



Canadian Standards Association (CSA): Association that generates product performance and safety standards for many Canadian industries.



Circle E: Designates a ballast meets or exceeds the requirements of Public Law 100-357 establishing standards of efficiency.

Constant Current LED System: System where the driver provides a constant output current and the modules are designed for that current rating or higher. Modules are constant current rated and have no current limiting.

Constant Voltage LED System: System where the driver provides a constant voltage output and the modules incorporate an integral current control device to regulate the LED current within the module. Drivers and modules must both have the same constant voltage rating and power loading must be compatible.

Crest Factor (Lamp Current Crest Factor): Ratio of peak lamp current to RMS or average lamp operating current.

Efficacy: Lumen output per unit of power supplied to ballast (lumens per watt).

EMI (Electromagnetic Interference): Electrical interference (noise) generated by electrical and electronic devices. Levels generated by high frequency electronic devices are subject to regulation by Federal Communications Commission (FCC).

Filament Voltage: Voltage applied to the lamp cathode.

Foot Candles: Measure of light level on a surface being illuminated. Defined as one lumen of light per one square foot of surface area.

Harmonic: An integral multiple of the fundamental frequency (60 Hz) that becomes a component of the current (see "Harmonic Distortion").

Harmonic Distortion: Distortion of an AC waveform caused by multiples of the fundamental frequency (harmonics). Odd triplet harmonics (thirds, ninths, etc.) may result in large currents on the neutral line in a four-wire Wye three-phase system.

High Efficiency (Energy Saving) Electromagnetic Ballast: Ballast with Core & Coils, designed to minimize ballast losses compared to the "standard" ballast.

High Intensity Discharge (HID) Lamp: A lamp containing a filled arc tube in which the active element becomes vaporized (a gaseous state) and is discharged into the arc stream to produce light.

High Power Factor: A ballast whose power factor is corrected to 90% or greater.

Incandescent Lamp: Lamp in which light is produced by a filament heated by an electric current.

Input Voltage: Power supply voltage required for proper operation of an arc discharge lighting ballast.

Instant Start (IS): Lamp starting method in which lamps are started by high voltage input with no preheating of lamp filaments. Some rapid start lamps are designed so that they may be instant started.

LED: Light Emitting Diode (LED) is a diode that produces light when the electrical current flows through it.

LED Driver: Similar to the function of a fluorescent ballast. It regulates output voltage or current for the LED module.

LED Module: A single component that includes LEDs, electrical connections, mounting plate/housing, optical interface, environmental protection, thermal interface and heat sinking.

Lumens/Watt: A measurement of white light produced by each output watt.

Parallel Lamp Operation: Refers to ballasts that employ multiple-output current paths independent of one another, allowing other lamps operated by the ballast to remain lit should companion lamp(s) fail.

Programmed Rapid Start (also Programmed Start): lamp starting method which preheats the lamp filaments while not allowing the lamp to ignite and then applies the open circuit voltage (OCV) to start the lamp. This type of starting circuit keeps lamp end blackening to a minimum and improves lamp life performance, especially in applications where the lamps are frequently switched on and off.

Rapid Start (RS): Lamp starting method in which lamp filaments are heated while open circuit voltage (OCV) is applied to facilitate lamp ignition.

Series Lamp Operation: Refers to ballasts that employ a single current path passing through all lamps operated by the ballast. If one lamp should fail, companion lamps operated by the same ballasts will also extinguish or dim.

Glossary

Trigger Start: A term used for electromagnetic ballasts which operate pre-heat start lamps in a rapid start manner. They supply higher filament voltages to heat the electrodes to start the pre-heat lamps, to simulate the rapid start system. A grounded reflector close to the lamp, together with a grounded line circuit, is required to provide a capacitive starting aid effect between lamps and fixture and assist ionization in the starting process.

UL (Underwriters' Laboratories, Inc.): Laboratory that sets safety standards for building materials, electrical appliances and other products.

Watts: Measurement of electrical ability to do work

Index

Catalog	Page #	Catalog	Page #
100305	6-9	109459	6-12
100310	6-9	109460	6-12
100720	6-16	109518	6-12
100732	6-11	109547	6-16
100912	6-16	109851	6-15
100928	6-11	109852	6-15
100946	6-15	109852	6-15
101035	6-15	109853	6-15
101248	6-16	109855	6-15, 6-16
101485	6-19	109856	6-15
101489	6-19	11102-45SC-TC	4-35
101491	6-19	1110-246C-TC	4-35
101493	6-19	1110-247SC-TC	4-35
101521	6-19	1110-564C-TC	4-35
102597	6-12	1110-566C-TC	4-35
102927	6-15	1110-568C-TC	4-35
102929	6-15	1111-246C-TC	4-35
106457	6-16	1111-247SC-TC	4-35
107065	6-11	1120-251A-TC	4-35
107195	6-16	11210-236C-TC	4-35
107652	6-11	11210-239C-TC	4-35
107677	6-11	11210-242C-TC	4-35
107694	6-15	11210-277C-TC	4-35
108257	6-11	11210-490C-TC	4-35
108756	6-16	11210-506C-TC	4-35
108851	6-12	11210-539C-TC	4-35
108869	6-12	11210-554C-TC	4-35
108870	6-12	11210-606C-TC	4-35
108891	6-12	12210-236C-TC	4-36
108892	6-15	12210-237C-TC	4-36
108893	6-11	12210-239C-TC	4-36
108913	6-11	12210-241C-TC	4-36
108925	6-15	12210-261C-TC	4-36
108979	6-16	12210-261RC-TC	4-36
109014	6-12	12210-552C-TC	4-36
109235	6-19	12210-602C-TC	4-36
109237	6-19	12210-606C-TC	4-36
109238	6-19	123310W	4-27
109239	6-19	1233142W	4-27
109240	6-19	1233154W	4-28
109241	6-19	1233251W	4-27
109272	6-12	123335W	4-27
109342	6-6	188156	5-3
109343	6-6	188157	5-3
109376	6-6	188164	5-3
109377	6-6	188165	5-3
109450	6-16	188166	5-3

Index

Catalog	Page #	Catalog	Page #
188167	5-3	400036	6-16
188168	5-3	400080	6-16
188169	5-3	404681	6-7
188246	5-3	500574	6-19
188301	5-3	500575	6-19
188302	5-3	501981	6-12
188514	5-3	501982	6-12
188574	5-3	502004	6-15
188610	5-3	502394	6-11
188611	5-3	504262	6-12
188612	5-3	504542	6-15, 6-16
188613	5-3	505732	6-9
188629	5-3	505733	6-9
188630	5-3	505734	6-9
188631	5-3	505735	6-9
188632	5-3	505736	6-9
188633	5-3	505737	6-9
188634	5-3	505739	6-9
188635	5-3	505745	6-9
188638	5-3	505746	6-9
188639	5-3	505747	6-9
188649	5-3	505750	6-9
188650	5-3	505751	6-9
188651	5-3	506216	6-11
188652	5-3	506381	6-12
188671	5-3	507656	6-11
188754	5-3	507992	6-19
188756	5-3	507993	6-19
188757	5-3	507994	6-19
188758	5-3	507995	6-19
188776	5-3	508306	6-15
188777	5-3	508314	6-19
188841	5-3	508590	6-9
188882	5-3	508610	6-15
188883	5-3	508611	6-15
188884	5-3	509035	6-15
188885	5-3	509069	6-15
188895	5-3	509134	6-6
188896	5-3	509135	6-6
188897	5-3	509136	6-6
188901	5-3	509137	6-6
188902	5-3	509180	6-6
188903	5-3	509213	6-11
188939	5-3	509356	6-11
188940	5-3	509357	6-15
188941	5-3	520728	6-15
188989	5-3	525523	6-12

Index

Catalog	Page #	Catalog	Page #
525681	6-15	536284	6-5
525681	6-15	536293	6-5
525750	6-11	536294	6-5
525857	6-15	536297	6-5
525857	6-15	536298	6-5
526018	6-11	536300	6-5
526211	6-11	536301	6-5
526246	6-11	536303	6-5
526251	6-11	536304	6-5
526755	6-19	536306	6-5
527560	6-19	536307	6-5
527561	6-19	536309	6-5
527564	6-19	536310	6-5
527565	6-19	536312	6-5
527566	6-19	536313	6-5
527589	6-19	536315	6-5
527590	6-19	536316	6-5
527594	6-19	536320	6-5
527595	6-19	536322	6-5
527596	6-19	536325	6-7
527794	6-19	536328	6-7
527795	6-19	536329	6-7
527798	6-19	536330	6-7
527799	6-19	536336	6-7
527800	6-19	536337	6-7
528120	6-19	536338	6-7
528121	6-19	536344	6-7
528124	6-19	536346	6-7
528125	6-19	536347	6-7
528126	6-19	536348	6-7
529699	6-15	536349	6-7
529773	6-11	536350	6-7
529773	6-11	536368	6-7
530250	6-15	536369	6-7
532685	6-19	536370	6-7
532687	6-19	536372	6-7
532689	6-19	536373	6-7
532691	6-19	536469	6-7
534050	6-11	536822	6-11
534101	6-11	536856	6-16
534102	6-11	536857	6-15
534105	6-11	536857	6-15
534132	6-15	537049	6-11
534218	6-11	537057	6-11
534219	6-11	537132	6-5
534636	6-11	537138	6-5
535782	6-11	537141	6-5

Index

Catalog	Page #	Catalog	Page #
537147	6-5	005-1418-BH	4-4
537150	6-5	005-1421-BH	4-4
537155	6-5	005-1422-BH	4-4
537165	6-5, 6-7	005-1464-BH	4-4
537166	6-7	005-1466-BH	4-4
537173	6-7	005-1467-BH	4-4
537174	6-7	005-1468-BH	4-4
537175	6-7	005-1474-BH	4-4
537181	6-7	005-1475-BH	4-4
537182	6-7	005-1495-BH	4-4
537183	6-7	005-1561-BH	4-4
537205	6-7	005-1594-BH	4-4
537206	6-7	005-1799-BH	4-4
537207	6-7	005-1884-BH	4-4
537454	6-11	005-1886-BH	4-4
537784	6-11	005-1887-BH	4-4
538286	6-15	005-1888-BH	4-4
538630	6-11	005-1893-BH	4-4
538634	6-11	005-2167-BH	4-4
542157	6-11	005-2351-BH	4-4
542304	6-11	005-2669-BH	4-4
543153	6-11	005-2776-BH	4-4
543963	6-11	005-2779-BH	4-4
545840	6-6	005-2793-BH	4-4
545842	6-6	005-3160-BH	4-4
545845	6-6	005-3278-BH	4-4
545849	6-6	493B2	1-46
545858	6-6	B114PUNV70-D	1-36
545862	6-6	B114PUNVDV3-D	2-16
545894	6-9	B114PUNVSV3-D	2-17
545896	6-9	B128PUNV50-D	1-36, 1-37
545933	6-9	B128PUNV60-D	1-36, 1-37
545935	6-9	B128PUNV70-D	1-36, 1-37
545937	6-9	B128PUNVDV3-D	2-16
545939	6-9	B128PUNVSV3-D	2-17
547807	6-11	B132I347HP	1-13, 1-15, 1-19
547808	6-11	B132IUNVHE-N	1-13, 1-15, 1-17, 1-19, 1-24, 1-26, 1-29, 1-32
001-2009	4-37	B132IUNVHP-N	1-13, 1-15, 1-19, 1-24, 1-26, 1-29, 1-32
005-1184-BH	4-4	B132PUNVDV3-A	2-16
005-1185-BH	4-4	B132PUNVSV3-A	2-17
005-1401-BH	4-4	B132R347V5	2-18
005-1410-BH	4-4	B135PUNV70-D	1-37
005-1411-BH	4-4	B135PUNVDV3-D	2-16
005-1413-BH	4-4	B135PUNVSV3-D	2-17
005-1414-BH	4-4	B214PU115S50A	2-20
005-1415-BH	4-4	B214PUNVDV3-D	2-16
005-1417-BH	4-4	B214PUNVSV3-D	2-17

Index

Catalog	Page #	Catalog	Page #
B224PUNV-C	1-38, 3-16, 3-17	B232SR277S30	2-19
B228P3DV3PLA	2-17	B232SR347V5	2-18
B228P3DV3PLD	2-17	B234SR120M-A	1-42, 1-43
B228P3SV3PLA	2-23	B234SR277M-A	1-42, 1-43
B228PU115S50D	2-20	B239PUNV-D	1-38, 3-17
B228PU95S50D	2-20	B240R220-A	1-43
B228PUDV3PLA	2-17	B254P347-D	1-38, 3-18, 3-19
B228PUDV3PLD	2-17	B254P3DV3PLD	2-17
B228PUNV-C	1-36, 1-37	B254P3SV3PLD	2-24
B228PUNV-N	1-36, 1-37	B254PHRVHB-E	1-38, 3-18, 3-19
B228PUNV115-D	1-9, 1-36, 1-37	B254PUDV3PLD	2-17
B228PUNV85-D	1-9, 1-36, 1-37	B254PUNV-D	1-38, 1-39, 1-40, 3-15, 3-17, 3-18, 3-19
B228PUNV90-C	1-9, 1-36, 1-37	B254PUNVHB-D	1-38, 1-39, 1-40, 3-15, 3-17, 3-18, 3-19
B228PUNV95-D	1-36, 1-37	B254PUNVPL-A	1-38, 1-39, 1-40, 1-41, 3-15, 3-17, 3-18, 3-19
B228PUNVDV3-D	2-16	B254PUNVPLHBA	1-38, 1-39, 1-40, 1-41, 3-15, 3-17, 3-18, 3-19
B228PUNVSV3-D	2-17	B254PUSV3PLD	2-24
B228PUSV3PLA	2-23	B259I347HP	1-32, 1-34
B232I120RES-A	1-13, 1-15, 1-19, 1-20	B259IUNVEL-A	1-34
B232I120RES-G	1-13, 1-15, 1-19, 1-20	B259IUNVHE-A	1-34
B232I347HP-A	1-13, 1-15, 1-19, 1-20, 1-24, 1-29, 1-32	B259IUNVHP-A	1-34
B232I347HPL	1-13, 1-15, 1-19, 1-20, 1-32	B260I120M-A	1-44, 1-45
B232IUNV-C	1-13, 1-15, 1-19, 1-20, 1-32, 1-42	B260IUNVHP	1-44, 1-45
B232IUNV104-A	1-13, 1-15, 1-26, 1-29	B286PUNVHE-S	1-35
B232IUNVEL-N	1-13, 1-15, 1-19, 1-20, 1-24, 1-26, 1-29	B295PUNVHE-S	1-46
B232IUNVHEH-A	1-13, 1-15, 1-19, 1-20, 1-24, 1-26, 1-29	B332I347HP	1-14, 1-16, 1-20, 1-21, 1-32, 3-17
B232IUNVHP-N	1-13, 1-15, 1-17, 1-19, 1-20, 1-24, 1-26, 1-29, 1-32	B332I347HPL	1-14, 1-16, 1-20, 1-21, 1-32
B232P3DV3PLA	2-17	B332IHRVHB-E	1-20, 1-21, 1-24, 1-25, 1-26, 1-27, 1-29, 1-30
B232P3DV3PLD	2-17	B332IUNVEL-A	1-14, 1-16, 1-20, 1-21, 1-24, 1-25, 1-26, 1-27, 1-29, 1-30, 1-32
B232P3S50PLA	2-26, 2-27	B332IUNVHE-A	1-14, 1-16, 1-20, 1-21, 1-24, 1-25, 1-26, 1-27, 1-29, 1-30, 1-32
B232P3S50PLHA	2-25	B332IUNVHP-A	1-14, 1-16, 1-20, 1-21, 1-24, 1-25, 1-26, 1-27, 1-29, 1-30, 1-32, 1-42
B232P3SV3PLA	2-22	B332PUNVEL-A	1-8, 1-14, 1-16, 1-21, 1-22, 1-25, 1-27, 1-28, 1-30, 1-32
B232PUDV3PLA	2-17	B332PUNVHE-A	1-8, 1-14, 1-15, 1-16, 1-21, 1-22, 1-25, 1-27, 1-28, 1-30
B232PUDV3PLD	2-17	B332PUNVHEH-A	1-8, 1-14, 1-15, 1-16, 1-21, 1-22, 1-25, 1-27, 1-28, 1-30
B232PUNVDV3-A	2-16	B332SR120S30	2-19
B232PUNVEL-B	1-8, 1-14, 1-15, 1-19, 1-21, 1-24, 1-25, 1-26, 1-27, 1-29, 1-30, 1-32	B332SR120V5	2-18
B232PUNVHE-B	1-8, 1-14, 1-15, 1-19, 1-21, 1-24, 1-25, 1-26, 1-27, 1-29, 1-30, 1-32	B332SR277S30	2-19
B232PUNVHEH-A	1-8, 1-14, 1-15, 1-19, 1-21, 1-24, 1-25, 1-26, 1-27, 1-29, 1-30	B332SR277V5	2-18
B232PUS50PLA	2-26, 2-27	B432I120RES-A	1-14, 1-16, 1-17, 1-21, 1-22
B232PUS50PLHA	2-25	B432I347HP	1-14, 1-17, 1-21, 1-22, 1-33
B232PUSV3PLA	2-22	B432I347HPL	1-14, 1-17, 1-21, 1-22, 1-33
B232SR120S30	2-19	B432IUNVEL-A	1-14, 1-17, 1-21, 1-22, 1-25, 1-26, 1-30, 1-31, 1-33

Index

Catalog	Page #	Catalog	Page #
B432IUNVHE-A	1-14, 1-17, 1-21, 1-22, 1-25, 1-26, 1-27, 1-28, 1-30, 1-31, 1-33	HPS15045B	4-38, 4-39
B432IUNVHP-A	1-14, 1-17, 1-21, 1-22, 1-25, 1-26, 1-27, 1-28, 1-30, 1-31, 1-33, 1-42	HPS1504A	4-38, 4-39
B432PUNVEL-A	1-8, 1-14, 1-17, 1-22, 1-25, 1-26, 1-28, 1-30, 1-31, 1-33	HPS1505A	4-38, 4-39
B432PUNVHE-A		HPS1505B	4-38, 4-39
B432PUNVHEH-E	1-8, 1-14, 1-16, 1-17, 1-22, 1-25, 1-26, 1-28, 1-30, 1-31	HPS150G01W	4-38, 4-39
B432SR277V5	2-18	HPS4003A	4-28, 4-29, 4-33, 4-38, 4-39
B454PUNV-E	1-38, 1-39, 3-18, 3-19	HPS40045B	4-38, 4-39
B454PUNVHB-E	1-38, 1-39, 3-18, 3-19	HPS4004A	4-38, 4-39
B454PUNVPL-E	1-38, 1-39, 1-40, 1-41, 3-18, 3-19	HPS400G05W	4-38, 4-39
B454PUNVPLHBE	1-38, 1-39, 1-40, 1-41, 3-18, 3-19	HPS4501B	4-38, 4-39
C140PUNVDV3	2-16	HPS4601B	4-38, 4-39
C213/347ME	3-2, 3-9, 3-12	HPS6001B	4-30, 4-38, 4-39
C213UNVDV3ME	2-16	M1000120AC5M	4-18
C213UNVME	3-2, 3-7, 3-9, 3-12	M1000230AC5M	4-33
C213UNVSV3ME	2-17	M100048TAC5M	4-12, 4-18
C218/347ME	3-2, 3-9, 3-12	M1000ML5AC5M	4-12, 4-18
C218UNVDV3ME	2-16	M1000MLTAC5M	4-12, 4-18
C218UNVME	3-2	M1000TRIAC5M	4-15, 4-18
C218UNVSV3ME	2-17	M10048TLC3M	4-13, 4-20
C226UNVDV3ME	2-16	M100MLTLC30	4-20
C226UNVSV3ME	2-17	M100MLTLC3D	4-13, 4-20
C232PUNVDV3	2-16	M100TRILC3M	4-15, 4-20
C240PUNVDV3	2-16	M1500230AC5M	4-33, 4-34
C240PUNVHP-B	3-7, 3-17	M150048TAC5M	4-12, 4-18
C240SI120RH	3-17	M1500MLTAC5M	4-12, 4-18
C240SI277RH	3-17	M1500TRIAC5M	4-15, 4-18
C242/347ME	3-9, 3-10, 3-13, 3-15, 3-16, 3-18	M150277RCEM	4-21
C242PUNVDV3	2-16	M15048TLC3M	4-13, 4-21
C2642/347ME	3-2, 3-9, 3-10, 3-13, 3-15, 3-16	M150MLTAC3M	4-13, 4-21
C2642UNVME	3-2	M150MLTLC3D	4-13, 4-21
C340SI120RH	3-17	M150MLTLC3M	4-13, 4-21
C340SI277RH	3-17	M150TRILC3M	4-15, 4-21
CF1320H2P	3-9	M175230AC3M	4-33
CT213UNVME	3-9	M17548TAC3M	4-12, 4-16
CT218UNVME	3-16	M175ML5AC3M	4-12, 4-16
ES1329A	1-15, 1-21	M175MLTAC3M	4-12, 4-16
ES1510A	1-13, 1-15, 1-19	M175TRIAC30	4-15, 4-16
ES1786X	1-47	M250230AC3M	4-33
ESB1040-14	7-4	M25048TAC3M	4-12, 4-16
ESB216-12	7-3, 7-4	M250ML5AC3M	4-12, 4-16
ESB432-14	7-3, 7-4	M250ML5AC4M	4-12, 4-17
ESB848-46	7-3, 7-4	M250MLTAC3M	4-12, 4-16
HPS10004B	4-25, 4-30, 4-33, 4-38, 4-39	M250MLTAC4M	4-12, 4-17
HPS10005A	4-38, 4-39	M250TRIAC3M	4-15, 4-16
HPS1503A	4-27, 4-33, 4-38, 4-39	M250TRIAC4M	4-15, 4-17

Index

Catalog	Page #	Catalog	Page #
M35MLTLC3M	4-13, 4-20	P400ML5AC4M	4-24
M35TRILC3M	4-15, 4-20	P400MLTAC4L	4-13, 4-24
M400120AC4M	4-17	P400TRIAC4M	4-15, 4-24
M400230AC4M	4-33	P45048TAC4L	4-13, 4-25
M40048TAC4M	4-12, 4-17	P450ML5AC4L	4-13, 4-25
M400ML5AC4M	4-12, 4-17	P450MLTAC4L	4-13, 4-25
M400MLTAC4M	4-12, 4-17	P75048TAC5M	4-13, 4-25
M400TRIAC40	4-17	P750ML5AC5M	4-13, 4-25
M400TRIAC4M	4-15	P750MLTAC5M	4-13, 4-25
M50MLTLC3M	4-13, 4-20	P750TRIAC5M	4-15, 4-25
M50TRILC3M	4-15, 4-20	P875MLTAC5M	4-13, 4-25
M7048TLC3M	4-13, 4-20	R17058501-BH	4-5
M70MLTLC3D	4-13, 4-20	R17058503-BH	4-5
M70MLTLC3M	4-13, 4-20	R17058507-BH	4-5
M70TRILC3M	4-15, 4-20	R17058509-BH	4-5
P100048TAC5M	4-25	R17058511-BH	4-5
P1000ML5AC5M	4-13, 4-25	R17058514-BH	4-5
P1000MLTAC5M	4-13, 4-25	R17058515-BH	4-5
P175277RCEM	4-21	R17058517-BH	4-5
P17548TAC3L	4-13, 4-21	R17058519-BH	4-5
P175MLTAC4L	4-13, 4-21	R17058520-BH	4-5
P175TRIAC3M	4-15, 4-21	R17058522-BH	4-5
P20048TAC3L	4-13, 4-22	R17058523-BH	4-5
P200ML5AC3M	4-13, 4-22	R17058529-BH	4-5
P200MLTAC3L	4-13, 4-22	R17058530-BH	4-5
P200TRIAC3M	4-15, 4-22	R17058532-BH	4-5
P25048TAC4L	4-13, 4-22	R17058533-BH	4-5
P250ML5AC4L	4-13, 4-22	R17058535-BH	4-5
P250MLTAC4L	4-13, 4-22	R17058536-BH	4-5
P250TRIAC4M	4-15, 4-22	R17058543-BH	4-5
P320277RCEM	4-22	R17058553-BH	4-5
P32048TAC4L	4-13, 4-23	R17058554	4-5
P320ML5AC4L	4-13, 4-23	R17058555-BH	4-5
P320ML5AC4M	4-13, 4-23	R17058557-BH	4-5
P320MLTAC40	4-22	R17058558-BH	4-5
P320TRIAC4M	4-15, 4-22	R17058560	4-5
P35048TAC40	4-23	R17058562-BH	4-5
P35048TAC4L	4-13, 4-23	R17058563-BH	4-5
P350ML5AC40	4-13, 4-23	R17058564	4-5
P350ML5AC4L	4-13, 4-23	R17058565-BH	4-5
P350ML5AC4M	4-13	R17058567-BH	4-5
P350MLTAC40	4-23	R17058569	4-5
P350MLTAC4M	4-13, 4-23	R17058571-BH	4-5
P350TRIAC4M	4-15, 4-23	R17058574-BH	4-5
P40048TAC4L	4-13, 4-24	S1000230AC5M	4-33
P40048TAC4M	4-24	S1000480AC5M	4-30
P400ML5AC4L	4-13, 4-24	S100048TAC5M	4-14, 4-30

Index

Index

Catalog	Page #	Catalog	Page #
S1000ML5AC5M	4-14, 4-30		
S1000MLTAC5M	4-14, 4-30		
S1000TRIAC5M	4-15, 4-30		
S100120RCEM	4-27		
S10048TLC3M	4-14, 4-27		
S100MLTLC3M	4-14, 4-27		
S100TRILC3M	4-15, 4-27		
S150120RCEM	4-28		
S15048TLC3M	4-14, 4-28		
S150TRILC3M	4-15, 4-28		
S20048TAC4M	4-14, 4-28		
S200MLTAC4M	4-14, 4-28		
S200TRIAC4M	4-28		
S250120AC4M	4-28		
S250230AC4M	4-33		
S25048TAC4M	4-14, 4-28		
S250MLTAC4M	4-14, 4-28		
S250TRIAC4M	4-28		
S35120RCEM	4-27		
S400230AC4M	4-33		
S40048TAC4M	4-14, 4-29		
S40048TAC5M	4-14, 4-29		
S400ML5AC4M	4-14, 4-29		
S400ML5AC5M	4-14, 4-29		
S400MLTAC4M	4-14, 4-29		
S400MLTAC5M	4-14, 4-29		
S400TRIAC4M	4-15, 4-29		
S400TRIAC5M	4-15, 4-29		
S430MLTAC4M	4-29		
S50120RCEM	4-27		
S50MLTLC3M	4-14, 4-27		
S600MLTAC5M	4-14, 4-30		
S70120RCEM	4-27		
S70230LC3M	4-33, 4-34		
S7048TLC3M	4-14, 4-27		
S70MLTLC3M	4-14, 4-27		
S70TRILC3M	4-15, 4-27		

LIMITED WARRANTY. Universal Lighting Technologies, 51 Century Blvd., Suite 230, Nashville, TN 37214-3683, 1-800-BALLAST, (hereinafter called “Universal”) warrants to the purchaser and first end-user purchaser only, that its lighting products (hereinafter called “Lighting Products”) will be free from defects in material and workmanship for the specified warranty periods listed below (each hereinafter called a “Warranty Period”). If any Lighting Product does not meet the limited warranty provided in the preceding sentence and such defect is reported to Universal during the applicable Warranty Period, then the sole obligation of Universal, and the SOLE AND EXCLUSIVE REMEDY under this limited warranty, shall be limited to the replacement of such non-performing Lighting Product with, at Universal’s sole discretion, the same type of Lighting Product or a Lighting Product which is substantially similar thereto. Other than with respect to the duration of the Warranty Period for the items denoted below with a (“**”) or separately agreed to in a written agreement, if any term or condition of this limited warranty conflicts with any term or condition of contained on any other document, including but not limited to Universal’s Terms and Conditions of Sale or any product specification sheet, Application and Performance Data Sheet or similar document for any Lighting Product (collectively “Product Specification Sheet”), the terms and conditions of this limited warranty shall control.

WARRANTY PERIODS. All Warranty Periods are measured beginning from the date of manufacture. Lighting Products not falling within one of the below listed categories shall have a Warranty Period of 12 months. The applicable Warranty Period for the type of Lighting Products listed below are as follows:

TRIAD Electronic Fluorescent Ballasts	up to 60 Months*
Universal, Energy Saving Electromagnetic Fluorescent Ballasts	36 Months
AddressPro, and DaliPro Ballasts	36 Months
SuperDim, LevelPro & VariPro	60 Months
Standard Universal Electromagnetic, Fluorescent & H.I.D. Ballasts	24 Months
Universal Sign Ballasts	24 Months
MAX-3 Series Sign Ballasts	36 Months
Basic-12 and Homestar Electronic Ballasts	36 Months
VS Lampholders	36 Months
VS Brand Magnetic IEC, Electronic IEC, Igniters, Switches and Capacitors	36 Months
Electronic HID	up to 60 Months*
LED Drivers	up to 60 Months*
LED Modules	36 Months**

* With respect to the items denoted above with a (“*”), the duration of the Warranty Period will vary depending on the specific Lighting Product. The exact Warranty Period for the items denoted with (“**”) shall be provided on the Product Specification Sheet, for such Lighting Product.

** **COVERED DEFECTS FOR LED MODULES.** For purposes of this limited warranty, a defect in a LED Module shall be defined as one or more individual LEDs dark at initial installation or > greater than 10% of individual LEDs dark during the Warranty Period. The Warranty Periods are based on 4000hrs/yr operation of the LED Lighting Products in normal operating conditions in compliance with the written specifications of Universal. Replacement and/or repair of individual LED Modules does not extend this limited warranty beyond the original Warranty Period.

EXCLUSIONS; TESTING. This limited warranty is conditional and excludes (i) Lighting Products which have been abused, altered, improperly or insufficiently maintained, or improperly operated, (ii) normal wear and tear or normal usage, (iii) any Lighting Product not installed and operated in accordance with the National Electric Code (NEC), the Standards for Safety of Underwriters Laboratories, Inc. (UL), Standards for the American National Standards Institute (ANSI), in Canada, the Canadian Standards Association (CSA), or the International Electrotechnical Commission (IEC). This limited warranty is not applicable to and excludes any Lighting Product which has not been installed and operated in accordance with Universal’s specifications and connection diagrams or Lighting Products which have been submitted to abnormal operating conditions. This includes, but is not limited to, excessive temperatures as specified in Universal’s published literature. The conditions for any tests (to be) performed on Lighting Products which are claimed to have not performed in accordance with the terms of this limited warranty shall be mutually agreed upon in writing and Universal may be represented at any such tests.

DISCLAIMER. TO THE FULLEST EXTENT PERMITTED BY LAW, UNIVERSAL DISCLAIMS ANY IMPLIED WARRANTY OF MERCHANTABILITY, FITNESS FOR A PARTICULAR PURPOSE, INFRINGEMENT, AND THOSE ARISING OUT OF PERFORMANCE OR DEALING OR USAGE OF TRADE OR ANY OTHER IMPLIED WARRANTY WITH RESPECT TO ANY LIGHTING PRODUCT(S). To the fullest extent permitted by law the foregoing limited warranty is exclusive and in lieu of all other statutory, written or oral warranties and no other warranties of any kind, statutory or otherwise, are given or herein expressed.

LIMITATIONS OF LIABILITY. To the fullest extent permitted by Law, this limited warranty sets forth the exclusive remedy available to any permitted claimant and under no circumstances, whether as a result of breach of contract, breach of warranty, tort, strict liability or otherwise, will Universal be liable for consequential, incidental, special or exemplary damages, including, but not limited to, loss of profits, loss of use or damage to any property or equipment, cost of capital, cost of substitute product, facilities or services, down time costs or claims of claimant’s customers. Universal’s liability for all claims of any kind or for any loss or damages arising out of, resulting from or concerning any aspect of this limited warranty or from the Lighting Products or services furnished hereunder, shall not exceed the price of the specific Lighting Product which gives right to the claim. This exclusive limited warranty shall not be deemed to have failed its essential purpose as long as Universal is willing and able to carry out the terms of this limited warranty.

WARRANTY REPORTING. The obligations of Universal under this limited warranty shall not arise unless Universal is notified in writing of a defect that is accompanied by a written statement specifying the claim of defect within sixty (60) days after an alleged defect is first known and no later than the expiration of the applicable Warranty Period. Any warranty claims and the supporting statement shall be sent to Universal’s Warranty department at the address listed below.

REQUIRED PROVISIONS DEEMED INSERTED. Each and every provision of any applicable law, regulation, and/or clause which is required by any applicable law or regulation to be inserted in this limited warranty shall be deemed to be inserted herein, and this limited warranty shall be read and enforced as though it were included herein, and if through mistake or otherwise any such provision is not inserted, or is not correctly inserted, then upon the written application of Universal or any purchaser or first end-user purchaser of the Lighting Products, this limited warranty shall forthwith be automatically amended to make such insertion or correction.

Email: TES@UNVLT.com

Universal Lighting Technologies
51 Century Blvd., Ste 230
Nashville, TN 37215

General Info: (615) 316-5100
For Technical Engineering Services (TES), application
support and warranty information, call 1-800-BALLAST

Website: www.unvlt.com
email: webmaster@unvlt.com

All specification information is subject to
change without notification. ULTNAV0614

Universal Lighting Technologies is a member of the Panasonic Group

Panasonic

