

**Rittal – The System.**

Faster – better – worldwide.



**Catalogue 33  
Edition 2012/2013**

**50**

**Rittal. Power and Vision!**

ENCLOSURES

POWER DISTRIBUTION

CLIMATE CONTROL

IT INFRASTRUCTURE

SOFTWARE & SERVICES



**Enclosures from page 23**

Small enclosures.....	27
Compact enclosures.....	43
Wall-mounted network enclosures.....	53
Enclosure systems.....	69
Floor-standing network enclosures.....	79
Server enclosures.....	91
Console systems/PC enclosure systems/IW.....	97
Operating housings/support arm systems/stand systems.....	113
Hygienic Design.....	153
Stainless steel.....	159
Ex enclosures/EMC.....	175
Outdoor enclosures.....	181

**Power from page 189**

UPS – Power Modular Concept.....	190
Power Distribution Rack.....	200
Power System Module.....	201
Fuel cell system.....	205

**Climate control from page 207**

Cooling with ambient air.....	211
Cooling units.....	231
Liquid cooling.....	251
IT cooling.....	271
CS Outdoor climate control.....	285
Climate control accessories.....	291

**IT infrastructure from page 307**

Wall-mounted/floor-standing network enclosures.....	53/79
Server enclosures.....	91
Power.....	189
IT cooling.....	271
Monitoring.....	577
Security solutions.....	321

**Software & services from page 333**

Software.....	337
Service.....	349
Quality management.....	353

**System accessories from page 355**

Enclosures.....	357
Monitoring.....	577
Human/machine interface.....	599
List of model numbers.....	625
Index.....	640



# Rittal – The System.

**Faster – better – worldwide.**

Dear Customer,

In 2011, Rittal can reflect on five very successful decades. For the past 50 years, we have been redefining the future, in every project. Together with our customers, we have developed an innovative, value-creating system with precise-fit solutions for almost every industry. The new Rittal Catalogue 33 2012/2013 contains more than 600 pages of detailed information on “Rittal – The System.”. Discover the many different facets of our unique range of solutions that is unrivalled anywhere else. Each day, “Rittal – The System.”, with its coordinated modular system, facilitates innovative solutions with maximum cost efficiency for companies of all sizes. Embark on a voyage of discovery. The future – your success – starts right here.

Best wishes

Friedhelm Loh  
Owner and CEO of the Friedhelm Loh Group

ENCLOSURES

POWER DISTRIBUTION

CLIMATE CONTROL

IT INFRASTRUCTURE

SOFTWARE & SERVICES



# Rittal – The System.

Faster – better – worldwide.

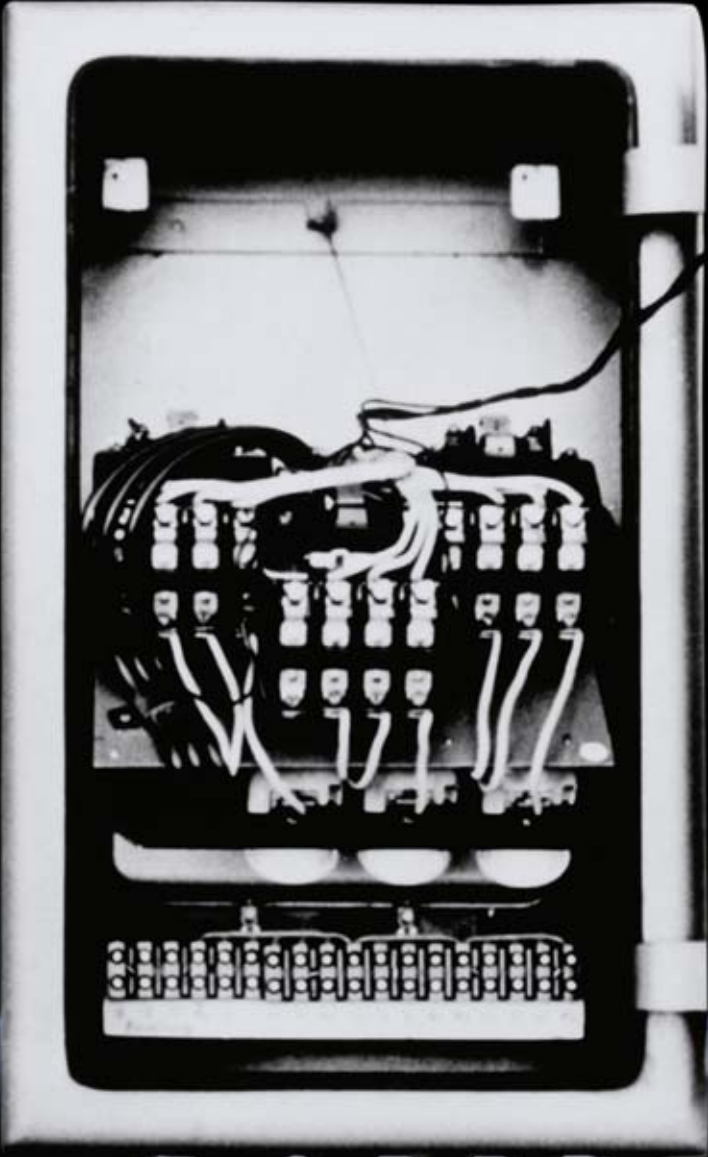

1961

1961: Series production of the very first standard enclosure, AE, begins.

ENCLOSURES

POWER DISTRIBUTION

CLIMATE CONTROL

# Setting standards.

## For 50 years, and well into the future.

To have been setting standards for 50 years, you not only need a good idea, but also the strength and ambition to implement it consistently. Rittal had the idea of producing standardised enclosures for its customers. This idea became a reality in 1961 with the very first standard enclosure AE, laying the foundations for long-term success.

Today, Rittal are world market leaders. We do not see this as a reason to rest on our laurels, but rather as an incentive for future outstanding achievements: By permanently improving our products and services and constant, innovative collaboration with our customers.

IT INFRASTRUCTURE

SOFTWARE & SERVICES



# Rittal – The System.

Faster – better – worldwide.



1969



1985

1969: Development of the modular series enclosure system RS.

1985: Presentation of the perfect enclosure system PS 4000. With more than 7.1 million units sold, it becomes a global standard.

1999: Perfecting of the global standard PS 4000 and extending it to infinite possibilities with the Top enclosure system TS 8.

ENCLOSURES

POWER DISTRIBUTION

CLIMATE CONTROL

FRIEDHELM LOH GROUP

# Perfect collaboration. For 50 years, and well into the future.

We attach great value to direct contact with our customers, with qualified employees who listen attentively and understand your concerns. This is what enabled us to develop ground-breaking product series such as the modular series enclosure system RS at an early stage, in collaboration with our customers. This cooperation is based on our many years of expertise and the unstinting willingness of our employees to acquire forward-thinking knowledge and implement it in a professional fashion. Our customers are still the most important source of new products and services. We continue this dialogue enthusiastically throughout every phase of the process, from the initial idea, to development of a solution, through to the use of our products.



1999

IT INFRASTRUCTURE

SOFTWARE & SERVICES



# Rittal – The System.

Faster – better – worldwide.



ENCLOSURES

POWER DISTRIBUTION

CLIMATE CONTROL

FRIEDHELM LOH GROUP



# Always two steps ahead. For 50 years, and well into the future.

Rittal always offers solutions that make its customers' business more efficient. One good example of this is the problem of heat generation in enclosures as a result of electronic components. Rittal has identified this problem and solved it by developing a wide range of climate control technologies. Highly efficient and versatile. With every innovation, we set new trends: With energy-saving cooling units with nano-technology, fan-and-filter units with innovative diagonal technology, modular recooling systems and modern software tools.



| 2002

| 2010



IT INFRASTRUCTURE

SOFTWARE & SERVICES



# Rittal – The System.

Faster – better – worldwide.

1988



2000

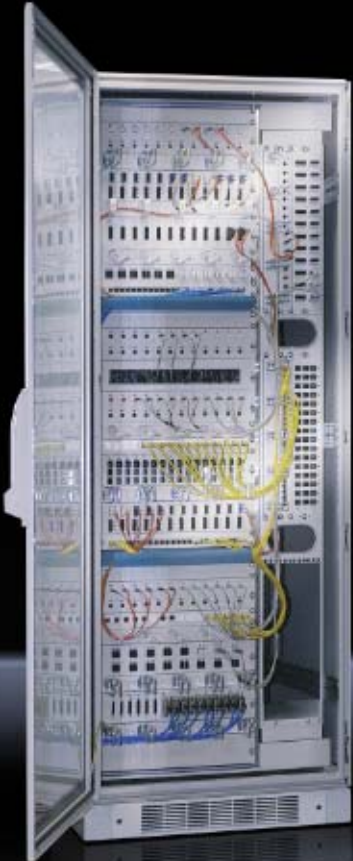

1988: Start of enclosure production for network technology.  
2000: Rittal IT racks with an extensive range of accessories for modern IT infrastructures.  
2011: Modular, scalable system solution for complete data centres.

ENCLOSURES

POWER DISTRIBUTION

CLIMATE CONTROL

FRIEDHELM LOH GROUP

# We are always there for you. For 50 years, and well into the future.

For years, we have seen increasing convergence between the IT and industrial markets. Back in 1988, Rittal seized on this opportunity, and has since used its industrial expertise to tap into global IT markets with the production of enclosures for modern network technologies. First, our experience and competency from industry were transferred to the individual components for IT use. From this, Rittal has continuously developed an unbeatable system solution with perfectly coordinated products and processes. Today, not only can our customers rely on pioneering solutions for super-efficient and reliable data centres, IT environments and infrastructures, but also on our global presence and availability.



2011

IT INFRASTRUCTURE

SOFTWARE & SERVICES



**Rittal – The System.**

**Faster – better – worldwide.**

# The future

**ENCLOSURES**

**POWER DISTRIBUTION**

**CLIMATE CONTROL**

FRIEDHELM LOH GROUP

# begins today!

The fact that we are not content to look to the past, but instead are always looking to the future, has been pivotal to our success in recent decades. And the same goes for the next 50 years. For Rittal, the future starts afresh with every project. Be it the development of new materials, product improvements, process optimisations or investing in new production sites around the globe, everything we do is to your benefit and your advantage.

IT INFRASTRUCTURE

SOFTWARE & SERVICES



# Rittal – The System.

Faster – better – worldwide.



| 2011

ENCLOSURES

POWER DISTRIBUTION

CLIMATE CONTROL

FRIEDHELM LOH GROUP

# Faster.

## For 50 years, and well into the future.

For Rittal, being faster is not an empty promise, but a claim that is practised throughout every area of the company, and that is linked to direct customer benefits:

- **Fast** development of innovations, with short paths and fast decision-making
- **Fast** tapping of new markets and industries
- **Fast**, problem-free use of all products worldwide, thanks to national and international approvals
- **Fast** individual solutions through direct product development in collaboration with customers
- **Faster** thanks to a perfect interplay between development, engineering, products and service
- **Faster** thanks to flexible project implementation with system solutions from a single source

# Rittal – The System.

Faster – better – worldwide.



2011

Axia Award, Diesel Medal, Top Employer, Prize for Innovation – these are just a few examples of what other people think of Rittal!

ENCLOSURES

POWER DISTRIBUTION

CLIMATE CONTROL

FRIEDHELM LOH GROUP



# Better.

## For 50 years, and well into the future.

Many companies promise to be better. Rittal really is better. This isn't just an empty claim; it has been confirmed by independent experts and selection jury members. They bear witness to our outstanding innovations and corporate achievements with positive analyses and awards. Most important of all for us, however, is the confirmation we get from our customers. For 50 years, they have been placing their trust in us, and therefore play a large part in our current position as global market leaders.

The reasons for this are:

- **Better** with powerful innovative strength and the associated safeguarding of competitive advantages on the market
- **Better** thanks to certified quality in management, production and environmental protection
- **Better** thanks to rational production on state-of-the art, automated production lines
- **Better** through targeted solutions that are designed to make our customers' lives easier
- **Better** thanks to the verifiable energy efficiency of our products with tangible cost savings
- **Better** with outstanding education and training, and superbly trained staff

# Rittal – The System.

Faster – better – worldwide.



| 2011

ENCLOSURES

POWER DISTRIBUTION

CLIMATE CONTROL

FRIEDHELM LOH GROUP

# Worldwide.

## For 50 years, and well into the future.

One major advantage that our customers really appreciate is our global presence.

For more than 50 years we have been on hand to offer advice, assistance and products.

Around the globe. We call this healthy customer relationships. It helps our customers to successfully tap into new markets. A dynamic status quo that we will be further expanding in future.

The cornerstones of our global availability:

- **Worldwide** thanks to outstanding logistics with 63 subsidiaries, 40 agencies, 100 warehouses with a total storage area of more than 160,000 m<sup>2</sup> worldwide
- **Worldwide** thanks to production sites on 3 continents, in 10 state-of-the-art plants with a total production area of more than 210,000 m<sup>2</sup>
- **Worldwide** thanks to global service with 5 global support points, more than 250 service partners and over 1,000 service engineers
- **Worldwide** thanks to international expertise with country-specific know-how and cross-regional approvals

# Rittal – The System.

Faster – better – worldwide.



FRIEDHELM  
**LOH**  
GROUP



2011

ENCLOSURES

POWER DISTRIBUTION

CLIMATE CONTROL

FRIEDHELM LOH GROUP

# Dynamic success.

## For 50 years, and well into the future.

Rittal – a global success for more than 50 years – is part of the dynamic Friedhelm Loh Group, which invests continuously in new technologies and markets. It specialises in the invention, development and production of customised products and system solutions. At the heart of its success is a lively and exemplary corporate culture which is wholly committed to ethical, social and environmental values with commercial responsibility.

The Friedhelm Loh Group includes the following specialists:

### **Rittal**

The world's leading system suppliers of enclosures, power distribution, climate control, IT infrastructure and software & services

### **Eplan**

Software for global engineering solutions

### **Mind8**

Solution providers for products that are available in a large number of versions and which require intensive explanation

### **Stahlo**

A modern steel service centre

### **LKH**

Processors of plastics in the hot pressing and injection moulding fields

### **Würz Energy**

Combined heat and power (CHP) units



# Enclosures

## Small enclosures

Polycarbonate enclosures PK .....	28
Aluminium enclosures GA .....	32
Terminal boxes KL .....	34
E-Box EB .....	37
Bus enclosures BG .....	39

## Compact enclosures

Compact enclosures AE .....	44
Compact system enclosures CM .....	48
Plastic enclosures KS .....	50

## Wall-mounted network enclosures

Wall-mounted enclosures .....	54
-------------------------------	----

## Enclosure systems

Baying systems TS 8 .....	70
---------------------------	----

## Network distribution enclosures

Network enclosures TS 8 .....	80
Network enclosures TE 7000 .....	85
Distributor racks .....	88

## Server enclosures

Server enclosures TS 8 .....	92
Server enclosures TE 7000 .....	95

## Console systems/PC enclosure systems/IW

TopConsole system TP .....	100
One-piece consoles TP .....	106
Universal consoles TP .....	107
PC enclosure systems .....	108
Enclosure for tower PC .....	109
Industrial Workstations .....	110

## Operating housings/support arm systems/ stand systems

Comfort Panel .....	116
Optipanel .....	118
Operating housings .....	120
Support arm systems .....	128
Stand systems .....	147

## Hygienic Design

Small and compact enclosures HD .....	154
---------------------------------------	-----

## Stainless steel

Enclosures .....	160
Support arm system CP-S .....	168
Enclosure systems .....	170

## Ex enclosures/EMC

Ex enclosures .....	176
EMC enclosures .....	178

## Outdoor enclosures

Outdoor enclosures .....	182
--------------------------	-----







# Competency in enclosure systems

---

As system providers, Rittal are the world's leading suppliers of innovative enclosure and case technology. Rittal meets very high standards of security, ergonomics, energy and cost efficiency.

## Your benefits

### Planning and engineering

- Software tools for targeted planning and project management
- Component library RiCAD 3D for efficient engineering

### Products

- Modular enclosure and case technology
- Extensive Rittal system solutions for a high level of investment reliability and maximum flexibility
- Compatibility with all types of applications: Industrial, IT, power distribution and climate control
- A comprehensive range of system accessories for individual installation and fast assembly

### Service

- Contiguous global delivery and service network
- Comprehensive quality management
- Our own accredited laboratories for tests, trials and protection category verification
- Global spare parts service
- AE Laser Express – Individual enclosures to order





# Small enclosures

---

## Polycarbonate enclosures PK

Polycarbonate enclosures PK .....	28
Polycarbonate enclosures PK, accessories .....	31

## Cast aluminium enclosures GA

Cast aluminium enclosures GA .....	32
Cast aluminium enclosures GA, accessories .....	33

## Terminal boxes KL

Terminal boxes KL .....	34
-------------------------	----

## E-Box EB

E-Box EB .....	37
----------------	----

## Bus enclosures BG

Bus enclosures BG .....	39
-------------------------	----



# Polycarbonate enclosures PK



PK accessories Page 31 System accessories Page 355 Polyamide cable gland Page 519

## Material:

- Housing of fibre-glass reinforced polyamide
- Cover either transparent (version .100) or grey (version .000), made from fibre-glass-reinforced polycarbonate
- Cover screws from polyamide
- Insulating bung from polyethylene
- All-round foamed-in PU seal

## Colour:

RAL 7035

## Protection category:

IP 66 to IEC 60 529

## Supply includes:

- Enclosure with cover
- Cover screws
- Insulating bungs for wall mounting screws

## Approvals:

- UL
- cUL
- Bureau Veritas

## Detailed drawing:

Available on the Internet.

Width mm		65	94	94	94	110	110	Page
Height mm		65	65	94	94	110	110	
Depth mm		57	57	57	81	66	90	
Model No. PK		<b>9500.000</b>	<b>9502.000</b>	<b>9504.000</b>	<b>9505.000</b>	<b>9506.000</b>	<b>9507.000</b>	
	Packs of	12	8	6	6	6	6	
Cover	Transparent	-	-	-	-	-	-	
	Grey	■	■	■	■	■	■	

## Accessories

Support rail TS 35/7.5	Installation in the width	12	-	-	9564.000	9564.000	9564.000	9564.000	31
	Installation in the height	12	-	-	9564.000	9564.000	9564.000	9564.000	31
Wall mounting brackets		40	9583.000	9583.000	9583.000	9583.000	9583.000	9583.000	31
Turn-lock fastener		100	9582.000	9582.000	9582.000	9582.000	9582.000	9582.000	31
Hinges		10 sets	9580.000	9580.000	9580.000	9580.000	9580.000	9580.000	31

Width mm		130	130	130	130	130	130	Page
Height mm		94	94	94	94	130	130	
Depth mm		57	57	81	81	75	75	
Model No. PK		<b>9508.100</b>	<b>9508.000</b>	<b>9509.100</b>	<b>9509.000</b>	<b>9510.100</b>	<b>9510.000</b>	
	Packs of	4	4	4	4	4	4	
Cover	Transparent	■	-	■	-	■	-	
	Grey	-	■	-	■	-	■	

## Accessories

Mounting plate			-	-	-	-	9545.000	9545.000	31
	Packs of		-	-	-	-	10	10	
Support rail TS 35/7.5	Installation in the width	12	9565.000	9565.000	9565.000	9565.000	9565.000	9565.000	31
	Installation in the height	12	9564.000	9564.000	9564.000	9564.000	9565.000	9565.000	31
Wall mounting brackets		40	9583.000	9583.000	9583.000	9583.000	9583.000	9583.000	31
Turn-lock fastener		100	9582.000	9582.000	9582.000	9582.000	9582.000	9582.000	31
Hinges		10 sets	9580.000	9580.000	9580.000	9580.000	9580.000	9580.000	31

# Polycarbonate enclosures PK

<b>Width</b> mm		130	130	180	180	180	180	Page
<b>Height</b> mm		130	130	94	94	94	94	
<b>Depth</b> mm		99	99	57	57	81	81	
<b>Model No. PK</b>		<b>9511.100</b>	<b>9511.000</b>	<b>9512.100</b>	<b>9512.000</b>	<b>9513.100</b>	<b>9513.000</b>	
	Packs of	4	4	2	2	2	2	
Cover	Transparent	■	–	■	–	■	–	
	Grey	–	■	–	■	–	■	

<b>Accessories</b>									
Mounting plate		9545.000	9545.000	–	–	–	–	–	31
	Packs of	10	10	–	–	–	–	–	
Support rail TS 35/7.5	Installation in the width	12	9565.000	9565.000	9566.000	9566.000	9566.000	9566.000	31
	Installation in the height	12	9565.000	9565.000	9564.000	9564.000	9564.000	9564.000	31
Wall mounting brackets		40	9583.000	9583.000	9583.000	9583.000	9583.000	9583.000	31
Turn-lock fastener		100	9582.000	9582.000	9582.000	9582.000	9582.000	9582.000	31
Hinges	10 sets	9580.000	9580.000	9580.000	9580.000	9580.000	9580.000	31	

<b>Width</b> mm		180	180	180	180	180	180	Page
<b>Height</b> mm		110	110	110	110	110	110	
<b>Depth</b> mm		90	90	111	111	165	165	
<b>Model No. PK</b>		<b>9514.100</b>	<b>9514.000</b>	<b>9515.100</b>	<b>9515.000</b>	<b>9516.100</b>	<b>9516.000</b>	
	Packs of	2	2	2	2	2	2	
Cover	Transparent	■	–	■	–	■	■	
	Grey	–	■	–	■	–	–	

<b>Accessories</b>									
Mounting plate		9547.000	9547.000	9547.000	9547.000	9547.000	9547.000	9547.000	31
	Packs of	10	10	10	10	10	10	10	
Support rail TS 35/7.5	Installation in the width	12	9566.000	9566.000	9566.000	9566.000	9566.000	9566.000	31
	Installation in the height	12	9564.000	9564.000	9564.000	9564.000	9564.000	9564.000	31
Wall mounting brackets		40	9583.000	9583.000	9583.000	9583.000	9583.000	9583.000	31
Turn-lock fastener		100	9582.000	9582.000	9582.000	9582.000	9582.000	9582.000	31
Hinges	10 sets	9581.000	9581.000	9581.000	9581.000	9581.000	9581.000	31	

<b>Width</b> mm		182	182	182	182	182	182	254	254	Page
<b>Height</b> mm		180	180	180	180	180	180	180	180	
<b>Depth</b> mm		90	90	111	111	165	165	90	90	
<b>Model No. PK</b>		<b>9517.100</b>	<b>9517.000</b>	<b>9518.100</b>	<b>9518.000</b>	<b>9519.100</b>	<b>9519.000</b>	<b>9520.100</b>	<b>9520.000</b>	
	Packs of	1	1	1	1	1	1	1	1	
Cover	Transparent	■	–	■	–	■	–	■	–	
	Grey	–	■	–	■	–	■	–	■	

<b>Accessories</b>										
Mounting plate		9548.000	9548.000	9548.000	9548.000	9548.000	9548.000	9549.000	9549.000	31
	Packs of	10	10	10	10	10	10	8	8	
Support rail TS 35/7.5	Installation in the width	12	9566.000	9566.000	9566.000	9566.000	9566.000	9567.000	9567.000	31
	Installation in the height	12	9566.000	9566.000	9566.000	9566.000	9566.000	9566.000	9566.000	31
Wall mounting brackets		40	9583.000	9583.000	9583.000	9583.000	9583.000	9583.000	9583.000	31
Turn-lock fastener		100	9582.000	9582.000	9582.000	9582.000	9582.000	9582.000	9582.000	31
Hinges	10 sets	9581.000	9581.000	9581.000	9581.000	9581.000	9581.000	9581.000	9581.000	31

<b>Width</b> mm		254	254	254	254	360	360	360	360	Page
<b>Height</b> mm		180	180	180	180	254	254	254	254	
<b>Depth</b> mm		111	111	165	165	111	111	165	165	
<b>Model No. PK</b>		<b>9521.100</b>	<b>9521.000</b>	<b>9522.100</b>	<b>9522.000</b>	<b>9523.100</b>	<b>9523.000</b>	<b>9524.100</b>	<b>9524.000</b>	
	Packs of	1	1	1	1	1	1	1	1	
Cover	Transparent	■	–	■	–	■	–	■	–	
	Grey	–	■	–	■	–	■	–	■	

<b>Accessories</b>										
Mounting plate		9549.000	9549.000	9549.000	9549.000	9550.000	9550.000	9550.000	9550.000	31
	Packs of	8	8	8	8	4	4	4	4	
Support rail TS 35/7.5	Installation in the width	12	9567.000	9567.000	9567.000	9567.000	9568.000	9568.000	9568.000	31
	Installation in the height	12	9566.000	9566.000	9566.000	9566.000	9567.000	9567.000	9567.000	31
Wall mounting brackets		40	9583.000	9583.000	9583.000	9583.000	9583.000	9583.000	9583.000	31
Turn-lock fastener		100	9582.000	9582.000	9582.000	9582.000	9582.000	9582.000	9582.000	31
Hinges	10 sets	9581.000	9581.000	9581.000	9581.000	9581.000	9581.000	9581.000	9581.000	31

# Polycarbonate enclosures PK



PK accessories Page 31 System accessories Page 355 Polyamide cable gland Page 519

## Material:

- Housing and cover of fibre-glass reinforced polyamide
- Cover screws from polyamide
- Insulating bung from polyethylene
- All-round foamed-in PU seal

## Colour:

RAL 7035

## Protection category:

IP 66 to IEC 60 529

## Supply includes:

- Enclosure with cover
- Cover screws
- Insulating bung for wall mounting screws (not with PK 9530.000 and PK 9531.000)

## Approvals:

- UL
- cUL
- Bureau Veritas

## Detailed drawing:

Available on the Internet.

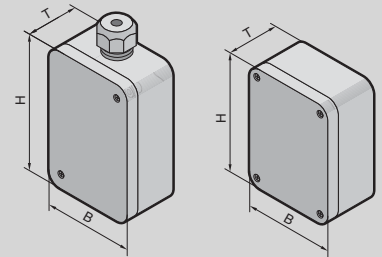

Width (B) mm		65	130	180	254	50	50	Page
Height (H) mm		65	94	110	180	52	65	
Depth (T) mm		57	57	90	111	35	35	
Model No. PK		<b>9500.050</b>	<b>9508.050</b>	<b>9514.050</b>	<b>9521.050</b>	<b>9530.000</b>	<b>9531.000</b>	
	Packs of	12	4	2	1	10	10	
Cover	Transparent	-	-	-	-	-	-	
	Grey	■	■	■	■	■	■	
No. of metric knockouts	M16/20	4	10	-	-	-	-	
	M20	-	-	16	24	-	-	
	M20/25	-	-	2	-	-	-	
	M25/32	-	-	-	4	-	-	
	M32/40	-	-	2	4	-	-	
Cable gland for cable diameter 5 – 10 mm		-	-	-	-	■	■	

## Accessories

Mounting plate		-	-	9547.000	9549.000	-	-	31
	Packs of	-	-	10	8	-	-	
Support rail TS 35/7.5	Installation in the width	12	-	9565.000	9566.000	9567.000	-	31
	Installation in the height	12	-	9564.000	9564.000	9566.000	-	31
Wall mounting brackets		40	9583.000	9583.000	9583.000	9583.000	-	31
Turn-lock fastener		100	9582.000	9582.000	9582.000	9582.000	-	31

Hole patterns for metric knockout available on the Internet.

# Polycarbonate enclosures PK

## Accessories

### Mounting plate

For universal interior installation.

**Material:**

2.5 mm melamine phenol-coated laminated paper.

**Colour:**

RAL 7035

**Supply includes:**

- Mounting plate
- Self-tapping assembly screws

For enclosure	Width mm	Height mm	Packs of	Model No. PK
PK 9510.000/.100, PK 9511.000/.100	110	110	10	<b>9545.000</b>
PK 9514.000/.100, PK 9514.050, PK 9515.000/.100, PK 9516.000/.100	150	90	10	<b>9547.000</b>
PK 9517.000/.100, PK 9518.000/.100, PK 9519.000/.100	150	150	10	<b>9548.000</b>
PK 9520.000/.100, PK 9521.000/.100, PK 9521.050, PK 9522.000/.100	220	150	8	<b>9549.000</b>
PK 9523.000/.100, PK 9524.000/.100	331	220	4	<b>9550.000</b>



### Support rail

The support rail section provides good flexibility for accommodating terminal blocks and installed components.

**Supply includes:**

- Support rails
- Self-tapping assembly screws

Rail	Rail length mm	Packs of	Model No. PK
TS 35/7.5	81	12	<b>9564.000</b>
	106	12	<b>9565.000</b>
	144	12	<b>9566.000</b>
	216	12	<b>9567.000</b>
	336	12	<b>9568.000</b>



### Turn-lock fastener

A quick, convenient screw fastening aid is obtained by clipping into the head of the lid screw.

**Material:**

Polyamide

**Colour:**

Similar to RAL 7035

	Packs of	Model No. PK
For all enclosures	100	<b>9582.000</b>

**Supply includes:**

1 pack = 100 pieces



### Hinges

For hinged attachment of covers.

The supplied drilling template ensures problem-free assembly.

**Colour:**

Similar to RAL 7035

**Supply includes:**

- 1 set =
- 2 hinges,
- 4 assembly screws,
- 4 polyethylene sealing bungs,
- 1 drilling template.

For enclosure	Material	Packs of	Model No. PK
PK 9500.000/.100 – PK 9513.000/.100	Polycarbonate	10 sets	<b>9580.000</b>
PK 9514.000/.100 – PK 9524.000/.100	Polystyrene	10 sets	<b>9581.000</b>



### Wall mounting brackets

The enclosure can be screwed to the wall using four wall mounting brackets. The bracket is securely attached to the enclosure by means of pins.

**Material:**

Polyamide, grey

**Colour:**

Similar to RAL 7035

	Packs of	Model No. PK
For all enclosures	40	<b>9583.000</b>

**Supply includes:**

1 pack = 40 pieces



# Cast aluminium enclosures GA



**GA accessories** Page 33 **System accessories** Page 355

**Material:**

- Enclosure: Cast aluminium
- Cover: Cast aluminium, all-round foamed-in PU seal

**Surface finish:**

Textured paint

**Colour:**

RAL 7001

**Protection category:**

IP 66 to IEC 60 529, complies with NEMA 4.

**Supply includes:**

- Enclosure with cover
- Cover screws, captive
- Screws for attaching support rails
- Screw for connection of the PE conductor

**Detailed drawing:**

Available on the Internet.

<b>Width</b> mm		50	58	98	150	75	125	175	250	122	Page
<b>Height</b> mm		45	64	64	64	80	80	80	80	120	
<b>Depth</b> mm		30	34	35	35	57	57	57	57	80	
<b>Model No. GA</b>		<b>9100.210</b>	<b>9101.210</b>	<b>9102.210</b>	<b>9103.210</b>	<b>9104.210</b>	<b>9105.210</b>	<b>9106.210</b>	<b>9107.210</b>	<b>9108.210</b>	
	Packs of	6	5	3	2	1	1	1	1	1	

**Accessories**

Mounting plate		-	-	-	-	-	9105.700	-	-	9108.700	33	
	Packs of	-	-	-	-	-	10	-	-	2		
Support rail TS 35, length 2 m		see page 467										
Wall mounting brackets	2	-	-	-	-	-	-	-	-	-	9121.122	33
Hinge, exterior	2	-	-	-	-	-	-	-	-	-	9123.000	33
Earth straps		see page 501										
Cable gland		see page 519										

<b>Width</b> mm		220	360	160	260	360	202	280	334	330	Page
<b>Height</b> mm		120	120	160	160	160	232	232	233	230	
<b>Depth</b> mm		91	82	91	91	91	111	111	111	181	
<b>Model No. GA</b>		<b>9110.210</b>	<b>9111.210</b>	<b>9112.210</b>	<b>9113.210</b>	<b>9114.210</b>	<b>9116.210</b>	<b>9117.210</b>	<b>9118.210</b>	<b>9119.210</b>	
	Packs of	1	1	1	1	1	1	1	1	1	

**Accessories**

Mounting plate		9110.700	-	9112.700	9113.700	9114.700	9116.700	9117.700	9118.700	9118.700	33
	Packs of	2	-	2	2	1	1	1	1	1	
Support rail TS 35, length 2 m		see page 467									
Wall mounting brackets	2	9121.122	9121.122	9121.160	9121.160	9121.160	9121.230	9121.230	9121.230	9121.230	33
Hinge, exterior	2	9123.000	9123.000	9123.000	9123.000	9123.000	9123.000	9123.000	9123.000	9123.000	33
Earth straps		see page 501									
Cable gland		see page 519									



# Cast aluminium enclosures GA

## Accessories

### Mounting plate

For universal interior installation, with mounting holes.

**Material:**

Sheet steel, zinc-plated

Exterior dimensions mm		For GA enclosures	Packs of	Model No. GA
Width	Height			
114	69	9105.210	10	<b>9105.700</b>
109	107	9108.210	2	<b>9108.700</b>
207	107	9110.210	2	<b>9110.700</b>
144	142	9112.210	2	<b>9112.700</b>
245	142	9113.210	2	<b>9113.700</b>
346	142	9114.210	1	<b>9114.700</b>
183	214	9116.210	1	<b>9116.700</b>
264	214	9117.210	1	<b>9117.700</b>
314	214	9118.210/9119.210	1	<b>9118.700</b>



### Wall mounting bracket

For external mounting on surfaces – no need to dismantle the cover if pre-assembled.

**Material:**

Sheet steel, zinc-plated

For GA enclosures	Packs of	Model No. GA
9108.210/ 9110.210/ 9111.210	2	<b>9121.122</b>
9112.210/ 9113.210/ 9114.210	2	<b>9121.160</b>
9116.210/ 9117.210/ 9118.210/ 9119.210	2	<b>9121.230</b>



### Hinge, exterior

For fastening the cover to the enclosure base.

**Material:**

Die-cast aluminium

**Colour:**

RAL 7001

For GA enclosures	Packs of	Model No. GA
9108.210/ 9110.210/ 9111.210/ 9112.210/ 9113.210/ 9114.210/ 9116.210/ 9117.210/ 9118.210/ 9119.210	2 + 8 screws	<b>9123.000</b>



# Terminal boxes KL



System accessories Page 355 KL stainless steel Page 161 KL for Ex areas Page 176

#### Material:

- Enclosure: Sheet steel
- Cover: Sheet steel, all-round foamed-in PU seal

#### Surface finish:

Enclosure and cover: Dipcoat-primed, powder-coated on the outside, textured paint

#### Colour:

RAL 7035

#### Protection category:

- Without gland plate: IP 66 to IEC 60 529, complies with NEMA 4.
- With gland plate: IP 55 to IEC 60 529, complies with NEMA 12.

#### Supply includes:

- Enclosure with cover
- Quick-action screw including plastic bushes
- For enclosures with gland plate plus sheet steel gland plates with seals and assembly parts

#### Approvals

- UL
- CSA
- TÜV
- Germanischer Lloyd
- Russian Maritime Register of Shipping
- Lloyds Register of Shipping
- Bureau Veritas
- VDE

#### Detailed drawing:

Available on the Internet.

Width mm	Packs of	150	200	200	300	300	400	Page
Height mm		150	150	200	150	200	200	
Depth mm		80	80	80	80	80	80	
Material thickness mm	Enclosure	1.25	1.25	1.25	1.25	1.25	1.25	
	Cover	1.25	1.25	1.25	1.25	1.25	1.25	
<b>Model No. KL</b>	<b>1</b>	<b>1514.510</b>	<b>1528.510</b>	<b>1516.510</b>	<b>1515.510</b>	<b>1517.510</b>	<b>1518.510</b>	
Weight (kg)		1.4	1.6	1.9	2.1	2.6	3.2	
Gland plate		–	–	–	–	–	–	

<b>Accessories</b>								
Mounting plate	1	1560.700	1575.700	1562.700	1561.700	1563.700	1564.700	443
Support rail TS 35/7.5	10	2314.000	2315.000	2315.000	2316.000	2316.000	2317.000	467
Support rail TS 35/15	10	–	–	–	–	–	–	467
Cover retainer	3 pairs	1591.000	1591.000	1591.000	1591.000	1591.000	1591.000	425
Cover hinge	6	1592.000	1592.000	1592.000	1592.000	1592.000	1592.000	425
Earthing kit	5	2570.100	2570.100	2570.100	2570.100	2570.100	2570.100	503
Wall mounting bracket with 8 mm distance from wall	4	1590.000	1590.000	1590.000	1590.000	1590.000	1590.000	439
Spare quick-release fastener for KL	12	1593.000	1593.000	1593.000	1593.000	1593.000	1593.000	–

# Terminal boxes KL

Width mm	Packs of	150	200	200	300	300	300	300	300	Page
Height mm		150	150	200	150	150	200	200	300	
Depth mm		120	120	120	120	120	120	120	120	
Material thickness mm	Enclosure	1.25	1.25	1.25	1.25	1.25	1.25	1.25	1.38	
	Cover	1.25	1.25	1.25	1.25	1.25	1.25	1.25	1.25	
<b>Model No. KL</b>	1	<b>1500.510</b>	<b>1529.510</b>	<b>1502.510</b>	<b>1501.510</b>	<b>1530.510</b>	<b>1503.510</b>	<b>1531.510</b>	<b>1507.510</b>	
Gland plate		–	–	–	–	■	–	■	–	
Weight (kg)		1.6	1.8	2.3	2.6	2.7	3.0	3.3	4.0	

## Accessories

Gland plate (top + bottom)	Size		–	–	–	–	2	–	2	–
	Qty.		–	–	–	–	1 + 1	–	1 + 1	–
Gland plate (left + right)	Size		–	–	–	–	–	–	–	–
	Qty.		–	–	–	–	–	–	–	–
Mounting plate	1	1560.700	1575.700	1562.700	1561.700	1561.700	1563.700	1563.700	1567.700	443
Support rail TS 35/7.5	10	2314.000	2315.000	2315.000	2316.000	2316.000	2316.000	2316.000	2316.000	467
Cover retainer	3 pairs	1591.000	1591.000	1591.000	1591.000	1591.000	1591.000	1591.000	1591.000	425
Cover hinge	6	1592.000	1592.000	1592.000	1592.000	1592.000	1592.000	1592.000	1592.000	425
Earthing kit	5	2570.100	2570.100	2570.100	2570.100	2570.100	2570.100	2570.100	2570.100	503
Wall mounting bracket with 8 mm distance from wall	4	1590.000	1590.000	1590.000	1590.000	1590.000	1590.000	1590.000	1590.000	439
Spare quick-release fastener for KL	12	1593.000	1593.000	1593.000	1593.000	1593.000	1593.000	1593.000	1593.000	–

Width mm	Packs of	300	400	400	400	400	400	400	400	Page
Height mm		300	150	200	200	300	300	400	400	
Depth mm		120	120	120	120	120	120	120	120	
Material thickness mm	Enclosure	1.38	1.25	1.25	1.25	1.38	1.38	1.38	1.38	
	Cover	1.25	1.25	1.25	1.25	1.25	1.25	1.25	1.25	
<b>Model No. KL</b>	1	<b>1535.510</b>	<b>1589.510</b>	<b>1504.510</b>	<b>1532.510</b>	<b>1508.510</b>	<b>1536.510</b>	<b>1511.510</b>	<b>1539.510</b>	
Gland plate		■	–	–	■	–	■	–	■	
Weight (kg)		4.5	3.2	3.6	4.0	4.8	5.2	6.2	6.7	

## Accessories

Gland plate (top + bottom)	Size		2	–	–	2	–	2	–	2	From 514
	Qty.		1 + 1	–	–	1 + 1	–	1 + 1	–	1 + 1	
Gland plate (left + right)	Size		2	–	–	–	–	2	–	2	From 514
	Qty.		1 + 1	–	–	–	–	1 + 1	–	1 + 1	
Mounting plate	1	1567.700	1576.700	1564.700	1564.700	1568.700	1568.700	1571.700	1571.700	443	
Support rail TS 35/7.5	10	2316.000	2317.000	2317.000	2317.000	2317.000	2317.000	2317.000	2317.000	467	
Cover retainer	3 pairs	1591.000	1591.000	1591.000	1591.000	1591.000	1591.000	1591.000	1591.000	425	
Cover hinge	6	1592.000	1592.000	1592.000	1592.000	1592.000	1592.000	1592.000	1592.000	425	
Earthing kit	5	2570.100	2570.100	2570.100	2570.100	2570.100	2570.100	2570.100	2570.100	503	
Wall mounting bracket with 8 mm distance from wall	4	1590.000	1590.000	1590.000	1590.000	1590.000	1590.000	1590.000	1590.000	439	
Spare quick-release fastener for KL	12	1593.000	1593.000	1593.000	1593.000	1593.000	1593.000	1593.000	1593.000	–	



## Rittal Australia

RITTAL Pty. Ltd.  
 130 – 140 Parraweena Road  
 Miranda NSW 2228  
 Phone: +61 (2) 9525 2766  
 Fax: +61 (2) 9525 2888  
 E-mail: info@rittal.com.au • www.rittal.com.au

# Terminal boxes KL

Width mm	Packs of	500	500	500	500	Page
Height mm		200	200	300	300	
Depth mm		120	120	120	120	
Material thickness mm	Enclosure	1.25	1.25	1.38	1.38	
	Cover	1.25	1.25	1.25	1.25	
<b>Model No. KL</b>	1	<b>1505.510</b>	<b>1533.510</b>	<b>1509.510</b>	<b>1537.510</b>	
Gland plate		–	■	–	■	
Weight (kg)		4.4	4.9	5.8	5.2	
<b>Accessories</b>						
Gland plate (top + bottom)	Size	–	2	–	2	From 514
	Qty.	–	2 + 2	–	2 + 2	
Gland plate (left + right)	Size	–	–	–	2	From 514
	Qty.	–	–	–	1 + 1	
Mounting plate	1	1565.700	1565.700	1569.700	1569.700	443
Support rail TS 35/15	10	2318.000	2318.000	2318.000	2318.000	467
Cover retainer	3 pairs	1591.000	1591.000	1591.000	1591.000	425
Cover hinge	6	1592.000	1592.000	1592.000	1592.000	425
Earthing kit	5	2570.100	2570.100	2570.100	2570.100	503
Wall mounting bracket with 8 mm distance from wall	4	1590.000	1590.000	1590.000	1590.000	439
Spare quick-release fastener for KL	12	1593.000	1593.000	1593.000	1593.000	–



## Rittal Portugal

RITTAL – Sistemas Eléctricos e Electrónicos, Lda.

Z. I. de Rio Meão · Rua 8, no 228  
4520-475 – Rio Meão · Sta Maria da Feira

Phone: +351 25678 0210

Fax: +351 25678 0219

E-mail: info@rittal.pt · www.rittal.pt



**System accessories** Page 355 **E-Box EMC-shielded** Page 178

**Material:**

- Enclosure: Sheet steel
- Door: Sheet steel, all-round foamed-in PU seal

**Surface finish:**

- Enclosure and door: Dipcoat-primed, powder-coated on the outside, textured paint
- Mounting plate: Zinc-plated

**Colour:**

RAL 7035

**Protection category:**

IP 66 to IEC 60 529, complies with NEMA 4.

**Supply includes:**

- Enclosure with hinged door
- 180° hinge
- Cam lock with double-bit insert
- Mounting plate

**Approvals:**

- UL
- CSA
- TÜV
- Germanischer Lloyd
- Russian Maritime Register of Shipping
- Lloyds Register of Shipping
- Bureau Veritas
- VDE

**Detailed drawings:**

Available on the Internet.

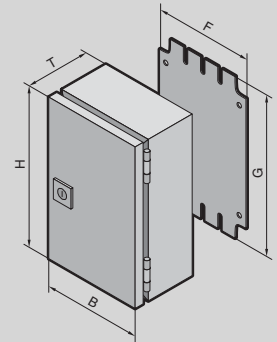

## Depth 120 mm

	Packs of	150	150	200	200	200	300	300	200	Page
<b>Width (B) mm</b>										
<b>Height (H) mm</b>		150	300	200	300	400	300	400	500	
<b>Depth (T) mm</b>		120	120	120	120	120	120	120	120	
Mounting plate width (F) mm		125	125	175	175	175	275	275	175	
Mounting plate height (G) mm		135	285	185	285	385	285	385	485	
Material thickness mm	Enclosure	1.25	1.25	1.25	1.25	1.25	1.38	1.38	1.25	
	Door	1.25	1.25	1.25	1.25	1.25	1.25	1.25	1.25	
<b>Model No. EB</b>	1	<b>1553.500</b>	<b>1548.500</b>	<b>1549.500</b>	<b>1554.500</b>	<b>1550.500</b>	<b>1555.500</b>	<b>1556.500</b>	<b>1557.500</b>	
Weight (kg)		2.0	3.0	2.8	3.6	5.0	5.0	6.4	6.2	

**Accessories**

Wall mounting bracket with 8 mm distance from wall	4	1590.000	1590.000	1590.000	1590.000	1590.000	1590.000	1590.000	1590.000	439
Pole clamp	1 set	2584.000	2584.000	2584.000	2584.000	2584.000	2584.000	2584.000	2584.000	441
Mounting clip	30	2309.000	2309.000	2309.000	2309.000	2309.000	2309.000	2309.000	2309.000	467
Support rail TS 35, length 2 m		see page 467								
Cable gland		see page 519								
Earth straps		see page 501								
Alternative lock systems		see page 411								

# E-Box EB

## Depth 155 mm

Width (B) mm	Packs of	300	300	300	Page
Height (H) mm		400	600	800	
Depth (T) mm		155	155	155	
Mounting plate width (F) mm		275	275	275	
Mounting plate height (G) mm		385	585	785	
Material thickness mm	Enclosure	1.38	1.38	1.38	
	Door	1.25	1.25	1.25	
<b>Model No. EB</b>	<b>1</b>	<b>1577.500</b>	<b>1578.500</b>	<b>1579.500</b>	
Weight (kg)		7.1	11.0	13.2	
<b>Accessories</b>					
Wall mounting bracket with 8 mm distance from wall	4	1590.000	1590.000	1590.000	439
Pole clamp	1 set	2584.000	2584.000	2584.000	441
Mounting clip	30	2309.000	2309.000	2309.000	467
Support rail TS 35, length 2 m			see page 467		
Cable gland			see page 519		
Earth straps			see page 501		
Alternative lock systems			see page 411		



## Rittal Brazil

RITTAL Sistemas Eletromecânicos Ltda.  
 Av. Cândido Portinari, 1174  
 VI Jaguara 05114-001 · São Paulo-SP  
 Phone: +55 (11) 3622 2377  
 Fax: +55 (11) 3622 2399  
 E-mail: info@rittal.com.br · www.rittal.com.br



**System accessories** Page 355

**Material:**

- Enclosure: Sheet steel
- Door: Sheet steel with polycarbonate viewing window, 4 mm

**Surface finish:**

Enclosure and door:  
Dipcoat-primed, powder-coated, textured paint

**Colour:**

RAL 7035

**Protection category:**

IP 65 to IEC 60 529, complies with NEMA 12.

**Supply includes:**

- Enclosure with door
- Viewing window in the door
- Product-specific supply scope, see tables

**Approvals:**

- TÜV
- Lloyds Register of Shipping
- VDE
- UL
- cUL

**Detailed drawings:**

Available on the Internet.

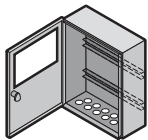

Width mm	Packs of	200	300	400	500	Page
Height mm		300	300	300	300	
Depth mm		80	80	80	80	
<b>Model No. BG</b>	1	<b>1583.520</b>	<b>1584.520</b>	<b>1585.520</b>	<b>1586.520</b>	
Material thickness mm	Enclosure	1.25	1.25	1.25	1.25	
	Door	1.25	1.25	1.25	1.25	
<b>Product-specific supply scope</b>						
Door hinge		Left	Left	Left	Left	
Cam lock with double-bit insert		1	1	1	1	
Support rail TS 35/7.5		2	2	2	2	
Number of metric holes	M12	2	2	2	3	
	M20	5	9	13	24	
	M25	2	2	3	-	
<b>Accessories</b>						
Lock cover	1	2476.000	2476.000	2476.000	2476.000	423
Cable glands		see page 519				
Wall mounting bracket		see page 439				
Pole clamp		see page 441				
Earth straps		see page 501				
Alternative lock systems		see page 411				

# Bus enclosures BG

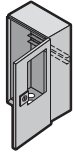

Width mm	Packs of	200	400	Page
Height mm		300	300	
Depth mm		120	120	
<b>Model No. BG</b>	1	<b>1605.520</b>	<b>1606.520</b>	
Material thickness mm	Enclosure	1.25	1.38	
	Door	1.25	1.25	
<b>Product-specific supply scope</b>				
Door hinge		Right	Right	
Cam lock with double-bit insert		1	1	
Support rail TS 35/7.5		1	1	
Number of metric holes	M12	2	–	
	M20	–	2	
	M32	5	9	
	M50	–	1	
<b>Accessories</b>				
Lock cover	1	2476.000	2476.000	423
Cable glands		see page 519		
Wall mounting bracket		see page 439		
Pole clamp		see page 441		
Earth straps		see page 501		
Alternative lock systems		see page 411		

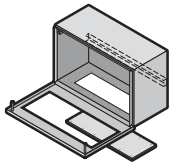

Width mm	Packs of	400	600	Page
Height mm		200	200	
Depth mm		125	125	
<b>Model No. BG</b>	1	<b>1558.510</b>	<b>1559.510</b>	
Material thickness mm	Enclosure	1.25	1.25	
	Door	1.25	1.25	
<b>Product-specific supply scope</b>				
Door hinge		Bottom	Bottom	
Quick-release fastener		2	3	
Support rail TS 35/7.5		1	1	
Gland plate in base		1	1	
<b>Accessories</b>				
Cable glands		see page 519		
Wall mounting bracket		see page 439		
Pole clamp		see page 441		
Earth straps		see page 501		
Alternative lock systems		see page 411		

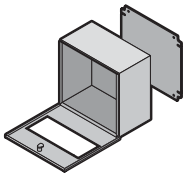

Width mm	Packs of	400	400	400	400	400	400	Page
Height mm		300	300	300	300	300	300	
Depth mm		155	155	155	155	155	155	
Mounting plate width		385	385	385	385	385	385	
Mounting plate height		275	275	275	275	275	275	
<b>Model No. BG</b>	1	<b>1577.500</b>	<b>1577.520<sup>1)</sup></b>	<b>1577.530<sup>1)</sup></b>	<b>1577.550<sup>1)</sup></b>	<b>1577.560<sup>1)</sup></b>	<b>1577.450<sup>1)</sup></b>	
Material thickness mm	Enclosure	1.38	1.38	1.38	1.38	1.38	1.38	
	Door	1.25	1.25	1.25	1.25	1.25	1.25	
<b>Product-specific supply scope</b>								
Door hinge		Bottom	Bottom	Bottom	Bottom	Bottom	Bottom	
Cam lock with double-bit insert		1	1	1	1	1	1	
Viewing window	Size mm	–	340 x 115	340 x 190	340 x 115	340 x 190	340 x 155	
	Position <sup>2)</sup> mm	–	92	42	92	42	92	
Mounting plate		1	1	1	1	1	1	
Gland plate in base		–	–	–	1	1	–	
<b>Accessories</b>								
Lock cover	1	2476.000	2476.000	2476.000	2476.000	2476.000	2476.000	423
Cable glands		see page 519						
Wall mounting bracket		see page 439						
Pole clamp		see page 441						
Earth straps		see page 501						
Alternative lock systems		see page 411						

<sup>1)</sup> Extended delivery times.

<sup>2)</sup> Bottom edge of window to bottom edge of door



# Bus enclosures BG

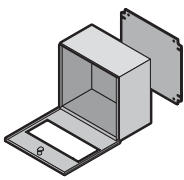

Width mm	Packs of	600	600	600	600	600	600	Page
Height mm		300	300	300	300	300	300	
Depth mm		155	155	155	155	155	155	
Mounting plate width		585	585	585	585	585	585	
Mounting plate height		275	275	275	275	275	275	
<b>Model No. BG</b>	1	<b>1578.500</b>	<b>1578.520<sup>1)</sup></b>	<b>1578.530<sup>1)</sup></b>	<b>1578.550<sup>1)</sup></b>	<b>1578.560<sup>1)</sup></b>	<b>1578.450<sup>1)</sup></b>	
Material thickness mm	Enclosure	1.38	1.38	1.38	1.38	1.38	1.38	
	Door	1.25	1.25	1.25	1.25	1.25	1.25	
<b>Product-specific supply scope</b>								
Door hinge		Bottom	Bottom	Bottom	Bottom	Bottom	Bottom	
Cam lock with double-bit insert		2	2	2	2	2	2	
Viewing window	Size mm	–	540 x 115	540 x 190	540 x 115	540 x 190	540 x 155	
	Position <sup>2)</sup> mm	–	92	42	92	42	92	
Mounting plate		1	1	1	1	1	1	
Gland plate in base		–	–	–	1	1	–	
<b>Accessories</b>								
Lock cover	1	2476.000	2476.000	2476.000	2476.000	2476.000	2476.000	423
Cable glands		see page 519						
Wall mounting bracket		see page 439						
Pole clamp		see page 441						
Earth straps		see page 501						
Alternative lock systems		see page 411						

<sup>1)</sup> Extended delivery times. <sup>2)</sup> Bottom edge of window to bottom edge of door

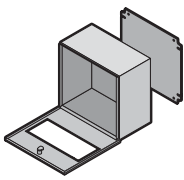

Width mm	Packs of	800	800	800	800	800	800	Page
Height mm		300	300	300	300	300	300	
Depth mm		155	155	155	155	155	155	
Mounting plate width		785	785	785	785	785	785	
Mounting plate height		275	275	275	275	275	275	
<b>Model No. BG</b>	1	<b>1579.500</b>	<b>1579.520<sup>1)</sup></b>	<b>1579.530<sup>1)</sup></b>	<b>1579.550<sup>1)</sup></b>	<b>1579.560<sup>1)</sup></b>	<b>1579.450<sup>1)</sup></b>	
Material thickness mm	Enclosure	1.38	1.38	1.38	1.38	1.38	1.38	
	Door	1.25	1.25	1.25	1.25	1.25	1.25	
<b>Product-specific supply scope</b>								
Door hinge		Bottom	Bottom	Bottom	Bottom	Bottom	Bottom	
Cam lock with double-bit insert		2	2	2	2	2	2	
Viewing window	Size mm	–	740 x 115	740 x 190	740 x 115	740 x 190	740 x 155	
	Position <sup>2)</sup> mm	–	92	42	92	42	92	
Mounting plate		1	1	1	1	1	1	
Gland plate in base		–	–	–	1	1	–	
<b>Accessories</b>								
Lock cover	1	2476.000	2476.000	2476.000	2476.000	2476.000	2476.000	423
Cable glands		see page 519						
Wall mounting bracket		see page 439						
Pole clamp		see page 441						
Earth straps		see page 501						
Alternative lock systems		see page 411						

<sup>1)</sup> Extended delivery times. <sup>2)</sup> Bottom edge of window to bottom edge of door

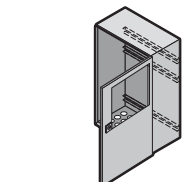
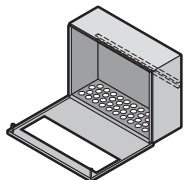
Width mm	Packs of	400	500	Page
Height mm		500	300	
Depth mm		160	120	
<b>Model No. BG</b>	1	<b>1611.510</b>	<b>1609.510</b>	
Material thickness mm	Enclosure	1.38	1.38	
	Door	1.5	1.25	
<b>Product-specific supply scope</b>				
Door hinge		Right	Bottom	
Cam lock with double-bit insert		1	–	
Quick-release fastener		–	2	
Support rail TS 35/7.5		3	1	
Number of drilled holes for PG 13.5 or M20		33	48	
<b>Accessories</b>				
Lock cover	1	2476.000	–	423
Cable glands		see page 519		
Wall mounting bracket		see page 439		
Pole clamp		see page 441		
Earth straps		see page 501		
Alternative lock systems		see page 411		



# Compact enclosures

---

## Compact enclosures AE

Compact enclosures AE.....44

## Compact system enclosures CM

Width: 600 – 800 mm, height: 800 – 1200 mm.....48

Width: 1000 – 1200 mm, height: 1000 – 1400 mm.....49

## Plastic enclosures KS

Plastic enclosures KS.....50



# Compact enclosures AE



System accessories Page 355 AE stainless steel Page 162 AE IP 69K Page 165 AE EMC-shielded Page 179 Hygienic Design Page 154

## Material:

- Enclosure: Sheet steel
- Door: Sheet steel, all-round foamed-in PU seal

## Surface finish:

- Enclosure and door: Dipcoat primed, powder-coated on the outside, textured paint
- Mounting plate: Zinc-plated

## Colour:

RAL 7035

## Protection category:

See tables.

## Supply includes:

- Enclosure with hinged door(s), of all-round solid construction
- Gland plate(s) in enclosure base
- For single-door enclosures, door hinged on right, may be swapped to left (except with AE 1032.500 and AE 1035.500)
- With cam lock or 3-point lock system
- Mounting plate

## Approvals:

- UL
- CSA
- TÜV
- Germanischer Lloyd
- Russian Maritime Register of Shipping
- Lloyds Register of Shipping
- Bureau Veritas
- VDE

## Detailed drawings:

Available on the Internet.

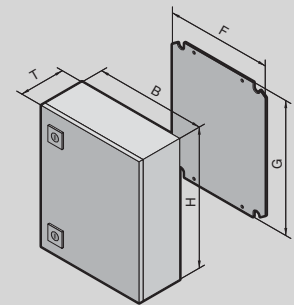

Width (B) mm	Packs of	200	200	300	300	380	380	380	Page
Height (H) mm		300	300	300	400	300	300	380	
Depth (T) mm		120	155	210	210	155	210	210	
Mounting plate width (F) mm		162	162	254	254	334	334	334	
Mounting plate height (G) mm		275	275	275	375	275	275	355	
Material thickness	Enclosure	1.25	1.25	1.38	1.38	1.38	1.38	1.38	
	Door	1.5	1.5	1.5	1.5	1.5	1.5	1.5	
Mounting plate thickness mm		2.0	2.0	2.0	2.0	2.0	2.0	2.0	
Cam lock		1	1	1	1	1	1	1	
<b>Model No. AE</b>	1	<b>1032.500</b>	<b>1035.500</b>	<b>1033.500</b>	<b>1034.500</b>	<b>1030.500</b>	<b>1031.500</b>	<b>1380.500</b>	
Weight (kg)		4.0	4.5	7.0	8.8	7.4	7.5	9.8	
<b>Protection category</b>	IP 66 to IEC 60 529, complies with NEMA 4.								

## Accessories

Accessory	Size	Qty.	1	1	–	–	3	3	3	From 514
Gland plate			1	1	–	–	3	3	3	From 514
Rails for interior installation		4	–	–	2373.210	2373.210	–	2373.210	2373.210	459
Wall mounting bracket for external mounting		4	2508.100	2508.100	2508.100	2508.100	2508.100	2508.100	2508.100	439
Baying kit		1 set	1199.100	1199.100	1199.100	1199.100	1199.100	1199.100	1199.100	400
Door stay		5	–	–	2519.000	2519.000	2519.000	2519.000	2519.000	429
180° hinges		2	2449.000	2449.000	2449.000	2449.000	2449.000	2449.000	2449.000	425
Rain canopies	Sheet steel	1	–	–	–	–	–	2501.500	2501.500	431
	Stainless steel	1	–	2470.000	2361.000	2361.000	2471.000	2472.000	2472.000	431
Earth straps										see page 501
LED system light										see page 494
Wiring plan pocket, plastic										see page 428
Cable gland										see page 519
Alternative lock systems										see page 411

# Compact enclosures AE

Width (B) mm	Packs of	380	380	400	500	500	500	500	Page	
Height (H) mm		600	600	500	500	500	700	700		
Depth (T) mm		210	350	210	210	300	250	250		
Mounting plate width (F) mm		334	334	354	449	449	449	449		
Mounting plate height (G) mm		570	570	475	470	470	670	670		
Material thickness mm	Enclosure	1.38	1.5	1.38	1.38	1.5	1.5	1.5		
	Door	1.5	1.5	1.5	1.75	1.75	2.0	2.0		
Mounting plate thickness mm		2.5	2.5	2.0	2.5	2.5	2.5	2.5		
Cam lock		2	2	2	2	2	2	2		
<b>Model No. AE</b>	1	<b>1038.500</b>	<b>1338.500</b>	<b>1045.500</b>	<b>1050.500</b>	<b>1350.500</b>	<b>1057.500</b>	<b>1057.500</b>		
Weight (kg)		15.6	19.4	13.0	16.8	19.6	31.2	31.2		
<b>Protection category</b>	IP 66 to IEC 60 529, complies with NEMA 4.									

<b>Accessories</b>										
Gland plate	Size		3	4	4	4	4	4	4	From
	Qty.		1	1	1	1	1	1	1	514
Rails for interior installation		4	2373.210	2373.350	2373.210	2373.210	2373.300	2373.250	2373.250	459
Wall mounting bracket for external mounting		4	2508.100	2508.100	2508.100	2508.100	2508.100	2508.100	2508.100	439
Baying kit		1 set	1199.100	1199.100	1199.100	1199.100	1199.100	1199.100	1199.100	400
Door stay		5	2519.000	2519.000	2519.000	2519.000	2519.000	2519.000	2519.000	429
180° hinge		2	2449.000	2449.000	2449.000	2449.000	2449.000	2449.000	2449.000	425
Support strips		20	–	–	–	2325.000	2325.000	2325.000	2325.000	426
Rain canopies	Sheet steel	1	2501.500	–	–	–	–	–	–	431
	Stainless steel	1	2472.000	–	–	2362.000	–	–	–	431
Earth straps										see page 501
LED system light										see page 494
Wiring plan pocket, plastic										see page 428
Cable gland										see page 519
Dust guard trim										see page 432
Alternative lock systems										see page 411

Width (B) mm	Packs of	600	600	600	600	600	600	600	600	600	Page
Height (H) mm		380	380	600	600	600	760	760	800	1000	
Depth (T) mm		210	350	210	250	350	210	350	250	250	
Mounting plate width (F) mm		549	549	549	549	549	549	549	549	539	
Mounting plate height (G) mm		355	355	570	570	570	730	730	770	955	
Material thickness mm	Enclosure	1.38	1.5	1.38	1.5	1.5	1.38	1.5	1.5	1.5	
	Door	1.5	1.5	1.75	1.75	1.75	2.0	2.0	2.0	2.0	
Mounting plate thickness mm		2.5	2.5	2.5	2.5	2.5	3.0	3.0	3.0	3.0	
Cam lock		1	1	2	2	2	2	2	2	2	
<b>Model No. AE</b>	1	<b>1039.500</b>	<b>1339.500</b>	<b>1060.500</b>	<b>1054.500</b>	<b>1360.500</b>	<b>1076.500</b>	<b>1376.500</b>	<b>1058.500</b>	<b>1090.500</b>	
Weight (kg)		15.4	20.0	22.8	24.8	28.4	32.1	36.0	33.6	50.5	
<b>Protection category</b>	IP 66 to IEC 60 529, complies with NEMA 4.										

<b>Accessories</b>											
Gland plate	Size		5	5	5	5	5	5	5	5	From
	Qty.		1	1	1	1	1	1	1	1	514
Rails for interior installation		4	2373.210	2373.350	2373.210	2373.250	2373.350	2373.210	2373.350	2373.250	459
Wall mounting bracket for external mounting		4	2508.100	2508.100	2508.100	2508.100	2508.100	2508.100	2508.100	2508.100	439
Baying kit		1 set	1199.100	1199.100	1199.100	1199.100	1199.100	1199.100	1199.100	–	400
Door stay		5	2519.000	2519.000	2519.000	2519.000	2519.000	2519.000	2519.000	2519.000	429
180° hinge		2	2449.000	2449.000	2449.000	2449.000	2449.000	2449.000	2449.000	2449.000	425
Support strips		20	2326.000	2326.000	2326.000	2326.000	2326.000	2326.000	2326.000	2326.000	426
Rain canopies	Sheet steel	1	2502.500	2511.500	2502.500	–	2511.500	2502.500	2511.500	–	431
	Stainless steel	1	2473.000	–	2473.000	–	–	2473.000	–	–	431
Earth straps											see page 501
LED system light											see page 494
Wiring plan pocket, plastic											see page 428
Cable gland											see page 519
Dust guard trim											see page 432
Alternative lock systems											see page 411

# Compact enclosures AE

Width (B) mm	Packs of	600	760	760	800	800	800	Page
Height (H) mm		1200	760	760	600	1000	1200	
Depth (T) mm		300	210	300	300	300	300	
Mounting plate width (F) mm		540	704	704	749	739	740	
Mounting plate height (G) mm		1155	730	730	570	955	1155	
Material thickness mm	Enclosure	1.5	1.5	1.5	1.5	1.5	1.5	
	Door	2.0	2.0	2.0	2.0	2.0	2.0	
Mounting plate thickness mm		3.0	3.0	3.0	2.5	3.0	3.0	
Cam lock		–	2	2	2	2	–	
3-point lock system		■	–	–	–	–	■	
<b>Model No. AE</b>	1	<b>1260.500</b>	<b>1077.500</b>	<b>1073.500</b>	<b>1055.500</b>	<b>1180.500</b>	<b>1280.500</b>	
Weight (kg)		55.0	40.0	44.5	33.9	57.0	70.0	
<b>Protection category</b>	IP 66 to IEC 60 529, complies with NEMA 4.							

<b>Accessories</b>									
Gland plate	Size		5	5	5	5	5	5	From 514
	Qty.		1	1	1	1	1	1	
Rails for interior installation		4	2373.300	2373.210	2373.300	2373.300	2373.300	2373.300	459
Wall mounting bracket for external mounting		4	2508.100	2508.100	2508.100	2508.100	2508.100	2508.100	439
Baying kit	1 set		–	1199.100	1199.100	1199.100	–	–	400
Door stay		5	2519.000	2519.000	2519.000	2519.000	2519.000	2519.000	429
180° hinge		2	2449.000	2449.000	2449.000	2449.000	2449.000	2449.000	425
Support strips		20	2326.000	2327.000	2327.000	2328.000	2328.000	2328.000	426
Rain canopies, stainless steel		1	–	–	2474.000	2475.000	2475.000	2475.000	431
Base/plinths	Height 100 mm	1	2816.200	–	–	–	–	2818.200	369
	Height 200 mm	1	2826.200	–	–	–	–	2828.200	369
Eyebolts		4	2509.000	–	–	–	–	2509.000	438
Earth straps									see page 501
LED system light									see page 494
Wiring plan pocket, plastic									see page 428
Cable gland									see page 519
Dust guard trim									see page 432
Alternative lock systems									see page 411

Width (B) mm	Packs of	1000	1000	1000	1000	1000	1000	Page
Height (H) mm		760	760	1000	1200	1400		
Depth (T) mm		210	300	300	300	300		
Mounting plate width (F) mm		944	944	939	940	940		
Mounting plate height (G) mm		730	730	955	1155	1355		
Material thickness mm	Enclosure	1.5	1.5	1.5	1.5	1.5		
	Door	2.0	2.0	2.0	2.0	2.0		
Mounting plate thickness mm		3.0	3.0	3.0	3.0	3.0		
Cam lock		2	2	2	–	–		
3-point lock system		–	–	–	■	■		
<b>Model No. AE</b>	1	<b>1100.500</b>	<b>1130.500</b>	<b>1110.500</b>	<b>1213.500</b>	<b>1114.500</b>		
Door(s)		2	2	2	2	2		
Weight (kg)		52.0	56.0	71.0	85.0	97.0		
<b>Protection category</b>	IP 55 to IEC 60 529, complies with NEMA 12.							

<b>Accessories</b>								
Gland plate	Size		4	4	4	4	4	From 514
	Qty.		2	2	2	2	2	
Rails for interior installation		4	2373.210	2373.300	2373.300	2373.300	2373.300	459
Wall mounting bracket for external mounting		4	2508.100	2508.100	2508.100	2508.100	2508.100	439
Baying kit	1 set		1199.100	1199.100	–	–	–	400
Door stay		5	2519.000	2519.000	2519.000	2519.000	2519.000	429
180° hinge		2	2449.000	2449.000	2449.000	2449.000	2449.000	425
Support strips		20	2325.000	2325.000	2325.000	2325.000	2325.000	426
Rain canopies, stainless steel		1	–	2363.000	2363.000	2363.000	2363.000	431
Base/plinths	Height 100 mm	1	–	2801.200	2801.200	2801.200	2801.200	369
	Height 200 mm	1	–	2802.200	2802.200	2802.200	2802.200	369
Eyebolts		4	–	–	–	2509.000	2509.000	438
Earth straps								see page 501
LED system light								see page 494
Wiring plan pocket, plastic								see page 428
Alternative lock systems								see page 411



# Compact system enclosures Rittal CM



**System accessories** Page 355 **System lights** Page 491 **Cable duct** Page 526 **Climate control** Page 207

## Material:

- Enclosure: Sheet steel, 1.5 mm
- Door: Sheet steel, 2.0 mm, all-round foamed-in PU seal
- Mounting plate: Sheet steel, 3.0 mm

## Surface finish:

- Enclosure and door: Dipcoat-primed, powder-coated on the outside, textured paint
- Mounting plate: Zinc-plated

## Colour:

RAL 7035

## Protection category:

IP 55 to IEC 60 529, complies with NEMA 12 provided suitable gland plates are selected.

## Supply includes:

- Enclosure with hinged door(s)
- R/h door hinge with single-door enclosures, may be swapped to opposite side
- 3-point lock
- Mounting plate
- Open base for individual cable entry



## Also required:

- Gland plates, see page 378 – 380
- Or trim panel, see page 381

## Approvals:

- UL
- CSA
- TÜV
- Lloyds Register of Shipping

## Detailed drawings:

Available on the Internet.

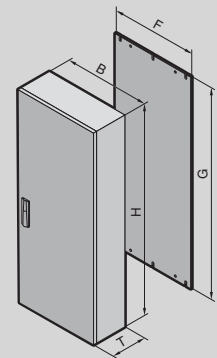

Width: 600 – 800 mm, height: 800 – 1200 mm

Width (B) mm	Packs of	600	600	600	600	800	800	800	800	Page	
Height (H) mm		800	1000	1200	1200	1000	1000	1200	1200		
Depth (T) mm		400	400	300	400	300	400	300	400		
Mounting plate width (F) mm		540	540	540	540	740	740	740	740		
Mounting plate height (G) mm		755	955	1155	1155	955	955	1155	1155		
<b>Model No. CM</b>	<b>1</b>	<b>5110.500</b>	<b>5111.500</b>	<b>5112.500</b>	<b>5113.500</b>	<b>5114.500</b>	<b>5115.500</b>	<b>5116.500</b>	<b>5117.500</b>		
Door		1	1	1	1	1	1	1	1		
<b>Base/plinths</b>											
Components front and rear	Height 100 mm	1 set	8601.600	8601.600	8601.600	8601.600	8601.800	8601.800	8601.800	8601.800	361
	Height 200 mm	1 set	8602.600	8602.600	8602.600	8602.600	8602.800	8602.800	8602.800	8602.800	361
Trim panels, sides	Height 100 mm	1 set	8601.040	8601.040	8601.030	8601.040	8601.030	8601.040	8601.030	8601.040	362
	Height 200 mm	1 set	8602.040	8602.040	8602.030	8602.040	8602.030	8602.040	8602.030	8602.040	362
<b>Accessories</b>											
Rail for interior installation	for height	4	5001.051	5001.052	5001.053	5001.053	5001.052	5001.052	5001.053	5001.053	459
	for width	4	5001.050	5001.050	5001.050	5001.050	5001.051	5001.051	5001.051	5001.051	459
Matching punched sections with mounting flanges	in depth	4	8612.140	8612.140	8612.130	8612.140	8612.130	8612.140	8612.130	8612.140	459
	in width	4	8612.060	8612.060	8612.060	8612.060	8612.080	8612.080	8612.080	8612.080	459
Base configuration rail		2	5001.370	5001.370	5001.371	5001.370	5001.371	5001.370	5001.371	5001.370	461
Mounting plate slide block		2	5001.070	5001.070	5001.070	5001.070	5001.070	5001.070	5001.070	5001.070	446
Support strips for door		20	4596.000	4596.000	4596.000	4596.000	4598.000	4598.000	4598.000	4598.000	426
TS punched section with mounting flange, 17 x 73 mm		4	8612.050	8612.050	8612.050	8612.050	–	–	–	–	459
Cable clamp rails		1	5001.080	5001.080	5001.080	5001.080	5001.081	5001.081	5001.081	5001.081	527
Sheet steel wiring plan pocket, depth 35 mm		1	4116.500	4116.500	4116.500	4116.500	4118.500	4118.500	4118.500	4118.500	429
Rain canopy/vented roof		1	5001.310	5001.310	–	5001.310	–	5001.330	–	5001.330	431
Alternative lock systems											see page 411



# Compact system enclosures Rittal CM

Width: 1000 – 1200 mm, height: 1000 – 1400 mm

Width (B) mm	Packs of	1000	1000	1000	1000	1000	1200	Page	
Height (H) mm		1000	1200	1200	1400	1400	1200		
Depth (T) mm		300	300	400	300	400	400		
Mounting plate width (F) mm		940	940	940	940	940	1140		
Mounting plate height (G) mm		955	1155	1155	1355	1355	1155		
<b>Model No. CM</b>	<b>1</b>	<b>5118.500</b>	<b>5119.500</b>	<b>5120.500</b>	<b>5121.500</b>	<b>5122.500</b>	<b>5123.500</b>		
Doors		2	2	2	2	2	2		
<b>Base/plinths</b>									
Components front and rear	Height 100 mm	1 set	8601.000	8601.000	8601.000	8601.000	8601.000	8601.200	361
	Height 200 mm	1 set	8602.000	8602.000	8602.000	8602.000	8602.000	8602.200	361
Trim panels, sides	Height 100 mm	1 set	8601.030	8601.030	8601.040	8601.030	8601.040	8601.040	362
	Height 200 mm	1 set	8602.030	8602.030	8602.040	8602.030	8602.040	8602.040	362
<b>Accessories</b>									
Rail for interior installation	for height	4	5001.052	5001.053	5001.053	5001.054	5001.054	5001.053	459
	for width	4	5001.052	5001.052	5001.052	5001.052	5001.052	5001.053	459
Matching punched sections with mounting flanges	in depth	4	8612.130	8612.130	8612.140	8612.130	8612.140	8612.140	459
	in width	4	8612.000	8612.000	8612.000	8612.000	8612.000	8612.020	459
Base configuration rail		2	5001.371	5001.371	5001.370	5001.371	5001.370	5001.370	461
Mounting plate slide block		2	5001.070	5001.070	5001.070	5001.070	5001.070	5001.070	446
Support strips for door		20	4309.000	4309.000	4309.000	4309.000	4309.000	4596.000	426
TS punched section with mounting flange, 17 x 73 mm		4	8612.040	8612.040	8612.040	8612.040	8612.040	8612.050	459
Cable clamp rails		1	5001.082	5001.082	5001.082	5001.082	5001.082	5001.083	527
Sheet steel wiring plan pocket, depth 35 mm		1	4115.500	4115.500	4115.500	4115.500	4115.500	4116.500	429
Rain canopy/vented roof		1	–	–	5001.350	–	5001.350	5001.360	431
Alternative lock systems					see page 411				



## Rittal China

RITTAL Electro-Mechanical Technology  
(Shanghai) Co. Ltd.  
No. 1658 Minyi Road · Songjiang District  
Shanghai, 201612  
Phone: +86 (0) 21 5115 7799  
Fax: +86 (0) 21 5115 7788  
E-mail: marketing@rittal.cn · www.rittal.cn

# Plastic enclosures KS



System accessories Page 355 **KS for potentially explosive areas** Page 177

## Material:

- Enclosure and door: Fibreglass-reinforced unsaturated polyester
- Mounting plate: Sheet steel
- Foamed-in PU seal

For KS with viewing window:

- Glazed acrylic, 3.0 mm with all-round rubber cable clamp strip

## Surface finish:

- Enclosure and door: Dyed plastic with no aftertreatment
- Mounting plate: Zinc-plated

## Protection category:

See table

## Colour:

Similar to RAL 7035

## Supply includes:

- Enclosure with hinged door, of all-round solid construction, 3 mm double-bit lock
- For single-door enclosures: R/h door hinge, may be swapped to opposite side by rotating the enclosure
- For two-door enclosures: Lockable door on right
- Mounting plate
- Twin seal on the top and bottom edges of the door as integral rain protection strip
- Press-fitted C sections at the sides for infinitely variable mounting plate depth adjustment
- KS 1400.500 additionally with removable centre bar in the enclosure

## Note:

Under the influence of long-term UV radiation (sunlight) in conjunction with wind and rain, the surface finish may become visually impaired. This does not affect the protection of the installed electrical components in any way. If the enclosures cannot be protected from UV radiation, we recommend that they should be painted with a PUR paint. Ambient temperature  $-30^{\circ}\text{C}$  to  $+75^{\circ}\text{C}$ .

## Approvals:

- TÜV
- Germanischer Lloyd
- Russian Maritime Register of Shipping
- Lloyds Register of Shipping
- Bureau Veritas
- VDE

## Detailed drawings:

Available on the Internet.

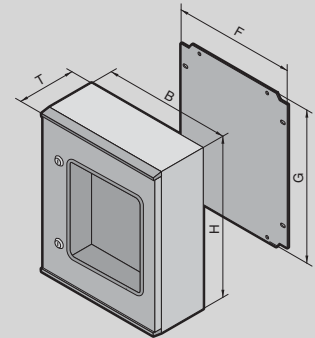

Width (B) mm	Packs of	200	250	300	400	400	400	400	500	Page
Height (H) mm		300	350	400	400	400	600	600	500	
Depth (T) mm		150	150	200	200	200	200	200	300	
Mounting plate width (F) mm		145	195	245	345	345	345	345	417	
Mounting plate height (G) mm		250	300	350	350	350	550	550	450	
Mounting plate thickness mm		2.0	2.0	2.0	2.5	2.5	2.5	2.5	2.5	
<b>Model No. KS</b>	1	<b>1423.500</b>	<b>1432.500</b>	<b>1434.500</b>	<b>1444.500</b>	<b>1448.500</b>	<b>1446.500</b>	<b>1449.500</b>	<b>1453.500</b>	
Door(s)		1	1	1	1	1	1	1	1	
Viewing window		–	–	–	–	■	–	■	–	
Cam lock		1	1	2	2	2	2	2	2	
3-point lock system		–	–	–	–	–	–	–	–	
Weight (kg)		3.4	4.3	5.9	7.9	8.0	11.5	11.2	13.5	
<b>Protection category</b>	IP 66 to IEC 60 529, complies with NEMA 4X.	■	■	■	■	–	■	–	■	
	IP 56 to IEC 60 529, complies with NEMA 12.	–	–	–	–	■	–	■	–	

## Accessories

Mounting plate adjustment bracket	4	1481.000	1481.000	1481.000	1481.000	1481.000	1481.000	1481.000	1491.000	446
Threaded inserts M6	20	1482.000	1482.000	1482.000	1482.000	1482.000	1482.000	1482.000	1482.000	478
Pole clamp	1 set	2584.000	2584.000	2584.000	2584.000	2584.000	2584.000	2584.000	2584.000	441
Wall mounting bracket	4	1483.010	1483.010	1483.010	1483.010	1483.010	1483.010	1483.010	1483.010	440
Alternative lock systems		see page 411								

# Plastic enclosures KS

<b>Width (B) mm</b>	Packs of	500	600	600	600	600	800	800	1000	Page
<b>Height (H) mm</b>		500	600	600	800	800	1000	1000	1000	
<b>Depth (T) mm</b>		300	200	200	300	300	300	300	300	
Mounting plate width (F) mm		417	545	545	517	517	717	717	917	
Mounting plate height (G) mm		450	550	550	750	750	950	950	950	
Mounting plate thickness mm		2.5	2.5	2.5	3.0	3.0	3.0	3.0	3.0	
<b>Model No. KS</b>	1	<b>1454.500</b>	<b>1466.500</b>	<b>1467.500</b>	<b>1468.500</b>	<b>1469.500</b>	<b>1480.500</b>	<b>1479.500</b>	<b>1400.500</b>	
Door(s)		1	1	1	1	1	1	1	2	
Viewing window		■	–	■	–	■	–	■	–	
Cam lock		2	2	2	–	–	–	–	–	
3-point lock system		–	–	–	■	■	■	■	■	
Weight (kg)		13.4	15.9	15.6	26.5	26.0	41.7	39.9	51.6	
<b>Protection category</b>	IP 66 to IEC 60 529, complies with NEMA 4X.	–	■	–	■	–	■	–	–	
	IP 56 to IEC 60 529, complies with NEMA 12.	■	–	■	–	■	–	■	■	

## Accessories

Mounting plate adjustment bracket	4	1491.000	1481.000	1481.000	1491.000	1491.000	1491.000	1491.000	1491.000	446
Threaded inserts M6	20	1482.000	1482.000	1482.000	1482.000	1482.000	1482.000	1482.000	1482.000	478
Pole clamp	1 set	2584.000	2584.000	2584.000	2584.000	2584.000	2584.000	2584.000	2584.000	441
Wall mounting bracket	4	1483.010	1483.010	1483.010	1483.010	1483.010	1483.010	1483.010	1483.010	440
Alternative lock systems		see page 411								



## Rittal Denmark

RITTAL A/S  
 Dybendalsvænget 4 · DK-2630 Taastrup  
 Phone: +45 70 25 59 00 · Fax: +45 70 25 59 01  
 E-mail: info@rittal.dk · www.rittal.dk



# Wall-mounted network enclosures

## Wall-mounted distributors

VerticalBox .....	54
FlatBox with 482.6 mm (19") mounting angles .....	55
FlatBox with 482.6 mm (19") mounting frame .....	56
QuickBox with glazed door .....	57
QuickBox with glazed door/sheet steel door .....	58
QuickBox with vertical 482.6 mm (19") level .....	59
Wall-mounted enclosures EL, 3-part, depth 573/673 mm, pre-configured ...	60
Wall-mounted enclosures EL, 3-part, depth 473 mm, with punched rails .....	61
Wall-mounted enclosures EL, 3-part, depth 373 mm, with mounting plate ...	62
Wall-mounted enclosures EL, 3-part, depth 473 mm, with mounting plate ...	63
Wall-mounted enclosures EL, 2-part, depth 369 mm, with swing frame .....	64
Wall-mounted enclosures AE with 482.6 mm (19") mounting angles .....	65
Wall-mounted enclosures AE with 482.6 mm (19") pull-out frame .....	66
Small fibre-optic distributors .....	67



# VerticalBox



System accessories Page 355

## Compact 482.6 mm (19") enclosure for small networks

- May be used as wall-mounted, under-desk or desktop enclosure
- 482.6 mm (19") level, front and rear
- Free access from three sides for interior installation
- Freely selectable door hinging
- Passive ventilation with vent slots
- Rear panel prepared to accommodate a fan
- Horizontal 10 U may be used by installing 482.6 mm (19") mounting angles

### Material:

- Sheet steel
- Viewing window: Single-pane safety glass, 3 mm

### Surface finish:

Powder-coated

### Colour:

RAL 7035

### Supply includes:

- Enclosure with glazed door
- Side panels (1 x fixed, 1 x slot-in) with vent slots
- Knockouts for cable entry via roof or base
- Slot-in rear panel with knockouts for cable entry and fan accommodation
- 482.6 mm (19") mounting level, 5 U, front and rear, depth-variable, distance between levels 434 – 489 mm
- Security lock 12321 on the door, side and rear panel
- 4 plastic feet, self-adhesive

### Detailed drawing:

Available on the Internet.

U	Packs of	5	Page
<b>Width</b> mm		300	
<b>Height</b> mm		540	
<b>Depth</b> mm		600	
<b>Model No. DK</b>	1	<b>7501.000</b>	
<b>Accessories</b>			
Mounting kit for VerticalBox, hinged mounting plate 350 x 484 mm	1	7501.100	567
482.6 mm (19") mounting angles, 12 U (10 U usable) <sup>1)</sup>	2	7502.203	554
Brush strip for cut-out openings	2 x 1 m	7072.200	518
Wall mounting bracket, 10 mm	4	2508.010	439
Wall mounting bracket, 40 mm	4	2503.010	439
Fan expansion kit, 230 V AC, 50/60 Hz, 108/125 m <sup>3</sup> /h, air throughput, unimpeded airflow	1 set	7980.100	222
Blanking panel, 482.6 mm (19"), 1 U, RAL 7035	2	7151.035	571
Cable management panel, 482.6 mm (19"), 1 U, RAL 7035, with 5 cable shunting rings 40 x 50 mm	1	7257.200	539
482.6 mm (19") socket strip, 7-way, with rocker switch	1	7240.220	505
Cable entry panel, 482.6 mm (19"), 1 U	1	7140.535	542

<sup>1)</sup> For mounting at the side of the VerticalBox. With these mounting angles, instead of 5 U vertically at the side, up to 10 U may be used horizontally if only a minimal installation depth is required. Infinitely depth-variable positioning.



**System accessories** Page 355

**For use as a wall-mounted and floor-standing enclosure. Small package – big performance. Time-saving, flexible, clever**

- For flexible use as a wall-mounted or floor-standing enclosure
- Maximum width and depth of 700 mm creates plenty of space for use as a patch distributor
- Toolless quick assembly
- System assembly on the open 482.6 mm (19") frame

**Material:**

- Sheet steel
- Viewing window: Single-pane safety glass, 3 mm

**Surface finish:**

Powder-coated

**Colour:**

RAL 7035

**Note:**

- Max. installation depth: D – 112 mm
- Max. distance between two 482.6 mm (19") levels: D – 126 mm

**Supply includes:**

- Flat-packed enclosure
- 1 wall section
- 2 basic supports
- 2 roof/base plates, with cut-outs for cable entry, with brush strips
- 2 mounting angles, 482.6 mm (19") (for 6 U and 9 U)
- 1 mounting frame 482.6 mm (19") (from 12 U)

- 4 levelling feet (from 12 U)
- 2 side panels, lockable
- 1 glazed door, lockable, security lock 3524 E, door hinge point selectable
- Connection components for toolless, fast assembly
- Earthing kit for system-compatible earthing of all enclosure parts

**Detailed drawing:**

Available on the Internet.

Photo shows a configuration example with equipment not included in the scope of supply.

## With 482.6 mm (19") mounting angles

U	Packs of	6	6	9	9	Page
Width mm		600	600	600	600	
Height mm		358	358	492	492	
Depth mm		400	600	400	600	
<b>Model No. DK</b>	1	<b>7507.000</b>	<b>7507.100</b>	<b>7507.010</b>	<b>7507.110</b>	
<b>Accessories</b>						
482.6 mm (19") mounting angles as second attachment level	2	7507.706	7507.706	7507.709	7507.709	554
Levelling feet	4	7507.740	7507.740	7507.740	7507.740	374
Cover plates for fan panels	6	7507.760	7507.760	7507.760	7507.760	222
Earth rail	1	7113.000	7113.000	7113.000	7113.000	504
C rail for cable clamping	1	7016.140	7016.140	7016.140	7016.140	532
T-head rail for cable clamping	1	7016.150	7016.150	7016.150	7016.150	532
Fan, 230 V AC, 50/60 Hz, 117/135 m³/h, air throughput, unimpeded airflow	1	7980.100	7980.100	7980.100	7980.100	222
Fan, 48 V DC, 184 m³/h, air throughput, unimpeded airflow	1	7980.148	7980.148	7980.148	7980.148	222
Enclosure internal thermostat	1	3110.000	3110.000	3110.000	3110.000	294
Cable management panel, 1 U, 5 cable shunting rings 40 x 50 mm	1	7257.200	7257.200	7257.200	7257.200	539
Component shelf 2 U, static installation, depth 250 mm	1	7119.250	7119.250	7119.250	7119.250	487
Component shelf 2 U, static installation, depth 400 mm	1	–	7119.400	–	7119.400	487
Component shelf 1 U, complete set, pull-out, depth 500 mm	1 set	–	7000.625	–	7000.625	486
Base/plinths	1	–	7507.750	–	7507.750	371

# FlatBox

With 482.6 mm (19") mounting frame

U	Packs of	12	12	15	15	18	21	Page
<b>Width</b> mm		600	600	600	700	700	700	
<b>Height</b> mm		625	625	758	758	892	1025	
<b>Depth</b> mm		400	600	400	700	700	700	
<b>Model No. DK</b>	1	<b>7507.020</b>	<b>7507.120</b>	<b>7507.030</b>	<b>7507.200</b>	<b>7507.210</b>	<b>7507.220</b>	
<b>Accessories</b>								
482.6 mm (19") mounting angles as second attachment level	2	7507.712	7507.712	7507.715	7507.715	7507.718	7507.721	554
Cover plates for fan panels	6	7507.760	7507.760	7507.760	7507.760	7507.760	7507.760	222
Earth rail	1	7113.000	7113.000	7113.000	7113.000	7113.000	7113.000	504
C rail for cable clamping	1	7016.140	7016.140	7016.140	7016.140	7016.140	7016.140	532
T-head rail for cable clamping	1	7016.150	7016.150	7016.150	7016.150	7016.150	7016.150	532
Fan, 230 V AC, 50/60 Hz, 117/135 m³/h, air throughput, unimpeded airflow	1	7980.100	7980.100	7980.100	7980.100	7980.100	7980.100	222
Fan, 48 V DC, 184 m³/h, air throughput, unimpeded airflow	1	7980.148	7980.148	7980.148	7980.148	7980.148	7980.148	222
Enclosure internal thermostat	1	3110.000	3110.000	3110.000	3110.000	3110.000	3110.000	294
Cable management panel, 1 U, 5 cable shunting rings 40 x 50 mm	1	7257.200	7257.200	7257.200	7257.200	7257.200	7257.200	539
Component shelf 2 U, static installation, depth 250 mm	1	7119.250	7119.250	7119.250	7119.250	7119.250	7119.250	487
Component shelf 2 U, static installation, depth 400 mm	1	–	7119.400	–	7119.400	7119.400	7119.400	487
Component shelf 1 U, complete set, pull-out, depth 500 mm	1 set	–	7000.625	–	7000.625	7000.625	7000.625	486
Base/plinths	1	–	7507.750	–	7507.755	7507.755	7507.755	371







## System accessories Page 355

**Wall-mounted enclosure with removable cover for perfect handling during installation and maintenance.**

**Material:**

- Wall mounting plate with mounting brackets: Sheet steel, 2.0 mm
- Enclosure cover: Sheet steel, 1.0 mm
- Door: Sheet steel door or glazed door with sheet steel frame and single-pane safety glass, 3 mm

**Surface finish:**

Enclosure: Powder-coated

**Colour:**

RAL 7035

**Supply includes:**

- Wall section:
- Pre-configured mounting bracket
- Brush strip for cable entry at the bottom/top
- Cable clamp rail
- 482.6 mm (19") mounting angles, fully depth adjustable

**Enclosure cover:**

- Base and cover tray with vent slots
- Brush strip for cable entry at the top/bottom
- 2 side security locks
- Sheet steel door or glazed door with security lock 12321
- Version with Ergoform-S lock system, may optionally be retrofitted with semi-cylinder

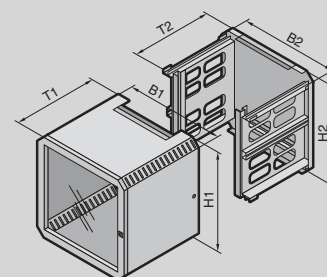

**Detailed drawings:**

Available on the Internet.

Photo shows a configuration example with equipment not included in the scope of supply.

## With glazed door

U	Packs of	6	6	6	9	9	12	12	12	12	Page	
Enclosure cover	Width (B1) mm	600	600	600	600	600	600	600	600	600		
	Height (H1) mm	362	362	362	495	495	628	628	628	628		
	Depth (T1) mm	300	400	600	400	600	400	500	600	600		
Wall section	Width (B2) mm	595	595	595	595	595	595	595	595	595		
	Height (H2) mm	355	355	355	488	488	621	621	621	621		
	Max. installation depth (T2) mm	247	347	547	347	547	347	447	547	547		
<b>Model No. DK</b>	1	<b>7502.013</b>	<b>7502.014</b>	<b>7502.016</b>	<b>7502.024</b>	<b>7502.026</b>	<b>7502.034</b>	<b>7502.035</b>	<b>7502.036</b>	<b>7502.436<sup>1)</sup></b>		
<b>Accessories</b>												
Mounting angles, 482.6 mm (19")	2	-	-	-	-	-	7502.203	7502.203	7502.203	7502.203	554	
Solid gland plate	2	7502.310	7502.310	7502.310	7502.310	7502.310	7502.310	7502.310	7502.310	7502.310	517	
Wall mounting bracket, 10 mm	4	2508.010	2508.010	2508.010	2508.010	2508.010	2508.010	2508.010	2508.010	2508.010	439	
Wall mounting bracket, 40 mm	4	2503.010	2503.010	2503.010	2503.010	2503.010	2503.010	2503.010	2503.010	2503.010	439	
Combination rails for enclosure width	6	7502.304	7502.304	7502.304	7502.304	7502.304	7502.304	7502.304	7502.304	7502.304	528	
Combination rails for enclosure depth	300/400 mm	6	7502.302	7502.302	7502.302	7502.302	7502.302	7502.302	7502.302	7502.302	528	
	500/600 mm	6	7502.304	7502.304	7502.304	7502.304	7502.304	7502.304	7502.304	7502.304	528	
Slide rails for the enclosure depth	300 mm	10	4530.000	4530.000	4530.000	4530.000	4530.000	4530.000	4530.000	4530.000	561	
	400 mm	2	4531.000	4531.000	4531.000	4531.000	4531.000	7492.300 <sup>2)</sup>	7492.300 <sup>2)</sup>	7492.300 <sup>2)</sup>	7492.300 <sup>2)</sup>	560/561
	500/600 mm		4531.000	4531.000	4531.000	4531.000	4531.000	7492.400 <sup>2)</sup>	7492.400 <sup>2)</sup>	7492.400 <sup>2)</sup>	7492.400 <sup>2)</sup>	560/561
Earthing kit	1	7502.240	7502.240	7502.260	7502.240	7502.260	7502.240	7502.260	7502.260	7502.260	503	
Quick-release fastener	2	7502.220	7502.220	7502.220	7502.220	7502.220	7502.220	7502.220	7502.220	7502.220	424	

<sup>1)</sup> With Ergoform-S lock system for semi-cylinder, for combining with quick-release fastener QB 7502.220.

<sup>2)</sup> Additional mounting angles required at the rear.

# QuickBox

## With glazed door

U	Packs of	15	15	15	15	18	18	21	21	Page
Enclosure cover	Width (B1) mm	600	600	600	600	600	600	600	600	
	Height (H1) mm	762	762	762	762	895	895	1028	1028	
	Depth (T1) mm	400	500	600	600	400	600	400	600	
Wall section	Width (B2) mm	595	595	595	595	595	595	595	595	
	Height (H2) mm	755	755	755	755	888	888	1021	1021	
	Max. installation depth (T2) mm	347	447	547	547	347	547	347	547	
<b>Model No. DK</b>	<b>1</b>	<b>7502.044</b>	<b>7502.045</b>	<b>7502.046</b>	<b>7502.446<sup>1)</sup></b>	<b>7502.054<sup>3)</sup></b>	<b>7502.056</b>	<b>7502.064<sup>3)</sup></b>	<b>7502.066</b>	

Accessories										
Mounting angles, 482.6 mm (19°)	2	7502.204	7502.204	7502.204	7502.204	7502.205	7502.205	7502.206	7502.206	554
Solid gland plate	2	7502.310	7502.310	7502.310	7502.310	7502.310	7502.310	7502.310	7502.310	517
Wall mounting bracket, 10 mm	4	2508.010	2508.010	2508.010	2508.010	2508.010	2508.010	2508.010	2508.010	439
Wall mounting bracket, 40 mm	4	2503.010	2503.010	2503.010	2503.010	2503.010	2503.010	2503.010	2503.010	439
Combination rails for enclosure width	6	7502.304	7502.304	7502.304	7502.304	7502.304	7502.304	7502.304	7502.304	528
Combination rails for enclosure depth	6	300/400 mm	7502.302	7502.302	7502.302	7502.302	7502.302	7502.302	7502.302	528
		500/600 mm	7502.304	7502.304	7502.304	7502.304	7502.304	7502.304	7502.304	7502.304
Slide rails for the enclosure depth	2	400 mm	7492.300 <sup>2)</sup>	7492.300 <sup>2)</sup>	7492.300 <sup>2)</sup>	7492.300 <sup>2)</sup>	7492.300 <sup>2)</sup>	7492.300 <sup>2)</sup>	7492.300 <sup>2)</sup>	560
		500/600 mm	7492.400 <sup>2)</sup>	7492.400 <sup>2)</sup>	7492.400 <sup>2)</sup>	7492.400 <sup>2)</sup>	7492.400 <sup>2)</sup>	7492.400 <sup>2)</sup>	7492.400 <sup>2)</sup>	560
Earthing kit	1	7502.240	7502.260	7502.260	7502.260	7502.240	7502.260	7502.240	7502.260	503
Quick-release fastener	2	7502.220	7502.220	7502.220	7502.220	7502.220	7502.220	7502.220	7502.220	424

<sup>1)</sup> With Ergoform-S lock system for semi-cylinder F, for combining with quick-release fastener QB 7502.220.

<sup>2)</sup> Additional mounting angles required at the rear.

<sup>3)</sup> Extended delivery times.

## With sheet steel door

U	Packs of	6	9	9	12	15	15	21	Page
Enclosure cover	Width (B1) mm	600	600	600	600	600	600	600	
	Height (H1) mm	362	495	495	628	762	762	1028	
	Depth (T1) mm	400	400	600	600	400	600	600	
Wall section	Width (B2) mm	595	595	595	595	595	595	595	
	Height (H2) mm	355	488	488	621	755	755	1021	
	Max. installation depth (T2) mm	347	347	547	547	347	547	547	
<b>Model No. DK</b>	<b>1</b>	<b>7502.114</b>	<b>7502.124</b>	<b>7502.126</b>	<b>7502.136</b>	<b>7502.144<sup>3)</sup></b>	<b>7502.146</b>	<b>7502.166<sup>3)</sup></b>	

Accessories										
Mounting angles, 482.6 mm (19°)	2	-	-	-	7502.203	7502.204	7502.204	7502.206	554	
Solid gland plate	2	7502.310	7502.310	7502.310	7502.310	7502.310	7502.310	7502.310	517	
Wall mounting bracket, 10 mm	4	2508.010	2508.010	2508.010	2508.010	2508.010	2508.010	2508.010	439	
Wall mounting bracket, 40 mm	4	2503.010	2503.010	2503.010	2503.010	2503.010	2503.010	2503.010	439	
Combination rails for enclosure width	6	7502.304	7502.304	7502.304	7502.304	7502.304	7502.304	7502.304	528	
Combination rails for enclosure depth	6	300/400 mm	7502.302	7502.302	7502.302	7502.302	7502.302	7502.302	528	
		500/600 mm	7502.304	7502.304	7502.304	7502.304	7502.304	7502.304	528	
Slide rails for the enclosure depth	10	300 mm	4530.000	4530.000	4530.000	4530.000	4530.000	4530.000	561	
		400 mm	4531.000	4531.000	4531.000	7492.300 <sup>2)</sup>	7492.300 <sup>2)</sup>	7492.300 <sup>2)</sup>	7492.300 <sup>2)</sup>	560/561
		500/600 mm	4531.000	4531.000	4531.000	7492.400 <sup>2)</sup>	7492.400 <sup>2)</sup>	7492.400 <sup>2)</sup>	7492.400 <sup>2)</sup>	560/561
Earthing kit	1	7502.240	7502.240	7502.260	7502.260	7502.240	7502.260	7502.260	503	
Quick-release fastener	2	7502.220	7502.220	7502.220	7502.220	7502.220	7502.220	7502.220	424	

<sup>2)</sup> Additional mounting angles required at the rear.

<sup>3)</sup> Extended delivery times.



## System accessories Page 355

### Wall-mounted enclosure with optimum use of the interior space

thanks to side installation of the 482.6 mm (19") components. Status monitoring via side viewing window.

#### Material:

- Wall mounting plate with mounting brackets: Sheet steel, 2.0 mm
- Enclosure cover: Sheet steel, 1.0 mm, with single-pane safety glass at the side, 3 mm

#### Surface finish:

Powder-coated

#### Colour:

RAL 7035

#### Supply includes:

##### Wall section:

- With pre-configured 482.6 mm (19") mounting brackets for accommodating equipment at the side
- Brush strip for cable entry at the bottom and top

##### Enclosure cover:

- Side vent slots to support passive climate control
- The enclosure is secured via two security locks positioned at the sides.

#### Detailed drawings:

Available on the Internet.

Photo shows a configuration example with equipment not included in the scope of supply.

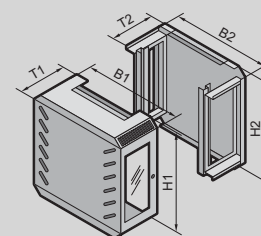

## With vertical 482.6 mm (19") level

U	Packs of	3	6	Page
Enclosure cover	Width (B1) mm	600	600	
	Height (H1) mm	631	631	
	Depth (T1) mm	210	360	
Wall section	Width (B2) mm	595	595	
	Height (H2) mm	621	621	
	Depth (T2) mm	198	348	
<b>Model No. DK</b>	1	<b>7502.630<sup>1)</sup></b>	<b>7502.660<sup>1)</sup></b>	
<b>Accessories</b>				
Gland plates, solid	2	7502.310	7502.310	517
Wall mounting bracket, 10 mm	4	2508.010	2508.010	439
Wall mounting bracket, 40 mm	4	2503.010	2503.010	439
Combination rails for vertical mounting on the QuickBox wall section	6	7502.304	7502.304	528
Combination rails for horizontal mounting on the QuickBox wall section	6	7502.304	7502.304	528
Mounting angles, 482.6 mm (19") for front mounting, 12 U	2	7502.203	7502.203	554

<sup>1)</sup> Extended delivery times.

# Wall-mounted enclosures EL, 3-part



**System accessories** Page 355 **Socket strips** Page 505 **Wall mounting bracket** Page 439 **Cable clamps** Page 529

## Wall-mounted enclosure with optimum accessibility thanks to hinged part.

### Material:

- Wall and hinged part: Sheet steel, 1.5 mm
- Viewing window: Single-pane safety glass, 3 mm

### Surface finish:

Powder-coated

### Colour:

- Wall and hinged part: RAL 7035
- Glazed door: RAL 7035/7015 (slate grey)

### Supply includes:

- Wall section
- Hinged part with 25 mm pitch pattern of holes in the front and rear frame
- Designer glazed door

- Mini comfort handle for 3 – 15 U
- Comfort handle and 2-point lock for 18 – 21 U
- Including security lock 3524 E
- Product-specific supply scope, see table

### Detailed drawings:

Available on the Internet.

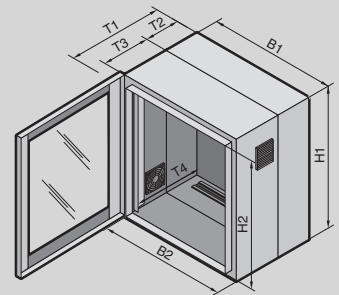

## Depth 573/673 mm, pre-configured

U	Packs of	9	9	15	15	21	21	Page	
<b>Width (B1) mm</b>		600	600	600	600	600	600		
<b>Height (H1) mm</b>		478	478	746	746	1012	1012		
<b>Depth (T1) mm</b>		573	673	573	673	573	673		
Clearance width (B2) mm		502	502	502	502	502	502		
Clearance height (H2) mm		415	415	683	683	949	949		
Depth of wall section (T2) mm		135	135	135	135	135	135		
Depth of hinged part (T3) mm		416	516	416	516	416	516		
Maximum installation depth (T4) mm		520	620	520	620	520	620		
Load capacity of hinged part (kg, static)		45	45	75	75	75	75		
Protection category IP 54 to IEC 60 529 when using solid gland plates SZ 2235.135		■	■	■	■	■	■		
<b>Model No. DK</b>	1	<b>7709.735</b>	<b>7709.535</b>	<b>7715.735</b>	<b>7715.535</b>	<b>7721.735</b>	<b>7721.535</b>		
<b>Product-specific supply scope</b>									
Walling section:	Gland plate, solid, top	1	■	■	■	■	■		
	Gland plate with brush insert, bottom	1	■	■	■	■	■		
	Vertical punched rails	2	■	■	■	■	■		
	Horizontal C rail	1	■	■	■	■	■		
Hinged part:	482.6 mm (19") mounting angles, fully depth adjustable	2	■	■	■	■	■		
	Side outlet filters left and right	2	■	■	■	■	■		
	Earth rail with star earthing	1 set	■	■	■	■	■		
	Wall mounting bracket, 10 mm	4	■	■	■	■	■		
<b>Accessories</b>									
	Gland plate for metric cable glands	1	7705.235	7705.235	7705.235	7705.235	7705.235	517	
	Fan expansion kit, 230 V	1	7980.100	7980.100	7980.100	7980.100	7980.100	222	
	Spare filter mats	5	3322.700	3322.700	3322.700	3322.700	3322.700	301	
	Wall mounting bracket, 40 mm	4	2503.010	–	2503.010	–	2503.010	439	
	Lock inserts, type F		see page 421						
	Component shelf 2 U, static installation or fully extendible, 300 mm deep	1	7148.035	7148.035	7148.035	7148.035	7148.035	485	
	Component shelf 2 U, static installation, 250 mm deep	1	7119.250	7119.250	7119.250	7119.250	7119.250	487	
	Cable management panel, 1 U, 5 cable shunting rings 40 x 50 mm	1	7257.200	7257.200	7257.200	7257.200	7257.200	539	

■ Included with the supply.

# Wall-mounted enclosures EL, 3-part



**System accessories** Page 355 **Socket strips** Page 505 **Wall mounting bracket** Page 439 **Earthing** Page 501 **Cable clamps** Page 529

## Wall-mounted enclosure with optimum accessibility thanks to hinged part.

### Material:

- Wall and hinged part: Sheet steel, 1.5 mm
- Viewing window: Single-pane safety glass, 3 mm

### Surface finish:

Powder-coated

### Colour:

- Wall and hinged part: RAL 7035
- Glazed door: RAL 7035/7015 (slate grey)

### Protection category:

IP 55 to IEC 60 529

### Supply includes:

- Wall section
- Hinged part with 25 mm pitch pattern of holes in the front and rear frame

- Designer glazed door
- Mini comfort handle for 3 – 15 U
- Comfort handle and 2-point lock for 18 – 21 U
- Including security lock 3524 E
- Product-specific supply scope, see table

### Detailed drawings:

Available on the Internet.

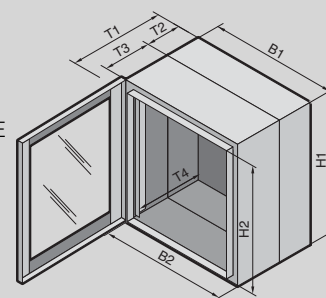

## Depth 473 mm, with punched rails

U	Packs of	6	9	12	15	18	21	Page	
<b>Width (B1) mm</b>		600	600	600	600	600	600		
<b>Height (H1) mm</b>		345	478	612	746	878	1012		
<b>Depth (T1) mm</b>		473	473	473	473	473	473		
Clearance width (B2) mm		502	502	502	502	502	502		
Clearance height (H2) mm		282	415	549	683	815	949		
Depth of wall section (T2) mm		135	135	135	135	135	135		
Depth of hinged part (T3) mm		316	316	316	316	316	316		
Maximum installation depth (T4) mm		420	420	420	420	420	420		
Load capacity of hinged part (kg, static)		30	45	60	75	75	75		
<b>Model No. DK</b>	1	<b>7706.135</b>	<b>7709.135</b>	<b>7712.135</b>	<b>7715.135</b>	<b>7718.135</b>	<b>7721.135</b>		
<b>Product-specific supply scope</b>									
Wall section:	Gland plate, solid, top and bottom	2	■	■	■	■	■		
	Vertical punched rails	2	■	■	■	■	■		
	Horizontal C rail for cable clamping	1	■	■	■	■	■		
Hinged part:	482.6 mm (19") mounting angles, fully depth adjustable	2	■	■	■	■	■		
	Wall mounting bracket, 10 mm	4	■	■	■	■	■		
<b>Accessories</b>									
	Gland plate with brush insert	1	7705.035	7705.035	7705.035	7705.035	7705.035	518	
	Gland plate for metric cable glands	1	7705.235	7705.235	7705.235	7705.235	7705.235	517	
	Wall mounting bracket, 40 mm	4	2503.010	2503.010	2503.010	2503.010	2503.010	439	
	Lock inserts, type F		see page 421						
	Earth rail, horizontal	1	7113.000	7113.000	7113.000	7113.000	7113.000	504	
	Component shelf 2 U, static installation and fully extendible	1	7148.035	7148.035	7148.035	7148.035	7148.035	485	
	Component shelf 2 U, static installation, 250 mm deep	1	7119.250	7119.250	7119.250	7119.250	7119.250	487	
	Component shelf 1 U, static installation, 140 mm deep	1	7119.140	7119.140	7119.140	7119.140	7119.140	486	
	Cable management panel, 1 U, 5 cable shunting rings 40 x 50 mm	1	7257.200	7257.200	7257.200	7257.200	7257.200	539	

■ Included with the supply.

# Wall-mounted enclosures EL, 3-part



System accessories Page 355 Socket strip Page 505 Wall mounting bracket Page 439 Cable clamps Page 529 Earthing Page 501

## Wall-mounted enclosure with optimum accessibility thanks to hinged part.

### Material:

- Wall and hinged part: Sheet steel, 1.5 mm
- Viewing window: Single-pane safety glass, 3 mm

### Surface finish:

Powder-coated

### Colour:

- Wall and hinged part: RAL 7035
- Glazed door: RAL 7035/7015 (slate grey)

### Protection category:

IP 55 to IEC 60 529

### Supply includes:

- Wall section
- Hinged part with 25 mm pitch pattern of holes in the front and rear frame

- Designer glazed door
- Mini comfort handle for 3 – 15 U
- Comfort handle and 2-point lock for 18 – 21 U
- Including security lock 3524 E
- Product-specific supply scope, see table

### Detailed drawings:

Available on the Internet.

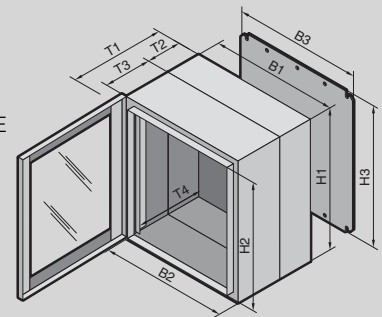

## Depth 373 mm, with mounting plate

U	Packs of	3	6	9	12	15	18	21	Page
Width (B1) mm		600	600	600	600	600	600	600	
Height (H1) mm		212	345	478	612	746	878	1012	
Depth (T1) mm		373	373	373	373	373	373	373	
Clearance width (B2) mm		502	502	502	502	502	502	502	
Clearance height (H2) mm		149	282	415	549	683	815	949	
Depth of wall section (T2) mm		135	135	135	135	135	135	135	
Depth of hinged part (T3) mm		216	216	216	216	216	216	216	
Maximum installation depth (T4) mm		320	320	320	320	320	320	320	
Width of mounting plate (B3) mm		485	485	485	485	485	485	485	
Height of mounting plate (H3) mm		165	299	432	565	699	832	965	
Load capacity of hinged part (kg, static)		15	30	45	60	75	75	75	
<b>Model No. EL</b>	1	<b>2243.605</b>	<b>2246.605</b>	<b>2249.605</b>	<b>2252.605</b>	<b>2255.605</b>	<b>2258.605</b>	<b>2261.605</b>	

### Product-specific supply scope

Wall section:	Gland plate, solid, top and bottom	2	■	■	■	■	■	■	
	Mounting plate supplied loose	1	■	■	■	■	■	■	
Hinged part:	482.6 mm (19") mounting angles	2	■	■	■	■	■	■	

### Accessories

Wall mounting bracket, 10 mm	4	2508.010	2508.010	2508.010	2508.010	2508.010	2508.010	2508.010	439
Wall mounting bracket, 40 mm	4	2503.010	2503.010	2503.010	2503.010	2503.010	2503.010	2503.010	439
Gland plate with brush insert	1	7705.035	7705.035	7705.035	7705.035	7705.035	7705.035	7705.035	518
Gland plate for metric cable glands	1	7705.235	7705.235	7705.235	7705.235	7705.235	7705.235	7705.235	517
Cable glands		see page 519							
Lock inserts, type F		see page 421							
C rails	4	2238.000	2238.000	2238.000	2238.000	2238.000	2238.000	2238.000	467
Blanking plates, 482.6 mm (19")	3	see page 564							

■ Included with the supply.

# Wall-mounted enclosures EL, 3-part

## Depth 473 mm, with mounting plate

U	Packs of	3	6	9	12	15	18	21	Page	
Width (B1) mm		600	600	600	600	600	600	600		
Height (H1) mm		212	345	478	612	746	878	1012		
Depth (T1) mm		473	473	473	473	473	473	473		
Clearance width (B2) mm		502	502	502	502	502	502	502		
Clearance height (H2) mm		149	282	415	549	683	815	949		
Depth of wall section (T2) mm		135	135	135	135	135	135	135		
Depth of hinged part (T3) mm		316	316	316	316	316	316	316		
Maximum installation depth (T4) mm		420	420	420	420	420	420	420		
Width of mounting plate (B3) mm		485	485	485	485	485	485	485		
Height of mounting plate (H3) mm		165	299	432	565	699	832	965		
Load capacity of hinged part (kg, static)		15	30	45	60	75	75	75		
<b>Model No. EL</b>	<b>1</b>	<b>2253.605</b>	<b>2256.605</b>	<b>2259.605</b>	<b>2262.605</b>	<b>2265.605</b>	<b>2268.605</b>	<b>2271.605</b>		
<b>Product-specific supply scope</b>										
Wall section:	Gland plate, solid, top and bottom	2	■	■	■	■	■	■		
	Mounting plate supplied loose	1	■	■	■	■	■	■		
Hinged part:	482.6 mm (19") mounting angles	2	■	■	■	■	■	■		
<b>Accessories</b>										
Wall mounting bracket, 10 mm		4	2508.010	2508.010	2508.010	2508.010	2508.010	2508.010	439	
Wall mounting bracket, 40 mm		4	2503.010	2503.010	2503.010	2503.010	2503.010	2503.010	439	
Gland plate with brush insert		1	7705.035	7705.035	7705.035	7705.035	7705.035	7705.035	518	
Gland plate for metric cable glands		1	7705.235	7705.235	7705.235	7705.235	7705.235	7705.235	517	
Cable glands			see page 519							
Lock inserts, type F			see page 421							
C rails		4	2239.000	2239.000	2239.000	2239.000	2239.000	2239.000	467	
Blanking plates, 482.6 mm (19")		3	see page 564							

■ Included with the supply.



## Rittal Great Britain

RITTAL Limited  
 Braithwell Way · Hellaby Industrial Estate  
 Hellaby · Rotherham · S Yorks S66 8QY  
 Phone: +44 (0) 1709 704000  
 Fax: +44 (0) 1709 701217  
 E-mail: [information@rittal.co.uk](mailto:information@rittal.co.uk)  
[www.rittal.co.uk](http://www.rittal.co.uk)

# Wall-mounted enclosures EL, 2-part



**System accessories** Page 355 **Cage nuts** Page 567 **Patch panel for copper technology** Page 569 **Socket strips** Page 505

## Wall-mounted enclosure with optimum accessibility thanks to swing frame.

### Material:

- Enclosure: Sheet steel, 1.5 mm
- Swing frame: Sheet steel
- Front door: Extruded aluminium section, acrylic glazing, 3 mm

### Surface finish:

- Enclosure and swing frame: Primed and powder-coated
- Front door: Anodised

### Colour:

- Enclosure and swing frame: RAL 7035
- Front door: Silver

### Protection category:

IP 55 to IEC 60 529

### Supply includes:

- Enclosure
- Front door
- Swing frame, 482.6 mm (19"), fitted
- Assembly parts

### Approvals:

- TÜV
- Russian Maritime Register of Shipping
- Lloyds Register of Shipping
- VDE
- UL/cUL
- Bureau Veritas
- Germanischer Lloyd

### Detailed drawings:

Available on the Internet.

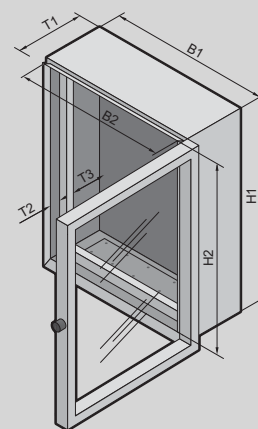

## Depth 369 mm, with swing frame

U	Packs of	6	11	14	Page
<b>Width (B1) mm</b>		600	600	600	
<b>Height (H1) mm</b>		380	600	760	
<b>Depth (T1) mm</b>		369	369	369	
Clearance width (B2) mm		537	537	537	
Clearance height (H2) mm		317	537	697	
Distance from glazed door to swing frame (T2) mm		67 – 97	67 – 97	67 – 97	
Maximum installation depth (T3) mm		270	270	270	
<b>Model No. EL</b>	1	<b>1919.500</b>	<b>1920.500</b>	<b>1926.500</b>	
<b>Accessories</b>					
Wall mounting bracket, 10 mm	4	2508.010	2508.010	2508.010	439
Wall mounting bracket, 40 mm	4	2503.010	2503.010	2503.010	439
Gland plates for metric cable glands	5	2563.010	2563.010	2563.010	514
Blanking plates, 482.6 mm (19")	3	see page 564			
Cable management panel, 482.6 mm (19"), 1 U, 5 cable shunting rings 40 x 50 mm	1	7257.200	7257.200	7257.200	539
Cable entry panel, 482.6 mm (19"), 1 U	1	7140.535	7140.535	7140.535	542

Standard swing frame with double-bit lock insert may be exchanged for 27 mm lock inserts, type A, see page 421.



# Wall-mounted enclosures AE



**System accessories** Page 355 **Socket strips** Page 505 **Captive nuts** Page 567 **Viewing panels** Page 407

## Wall-mounted enclosures for small networks with a high protection category.

**Material:**  
Enclosure: Sheet steel

**Surface finish:**  
– Enclosure: Powder-coated  
– Mounting angles: Zinc-plated

**Colour:**  
RAL 7035

**Protection category:**  
See table.

**Supply includes:**

- Enclosure with hinged door
- Interchangeable door hinge
- Cam lock and double-bit insert
- Gland plate with brush strip for cable entry in the enclosure base
- Product-specific supply scope, see table

**Approvals:**  
(except AE with pull-out frame)

- UL
- CSA
- Lloyds Register of Shipping
- Bureau Veritas
- TÜV
- VDE
- Germanischer Lloyd

**Detailed drawing:**  
Available on the Internet.

## With 482.6 mm (19") mounting angles

U	Packs of	8	13	16	Page
<b>Width</b> mm		600	600	600	
<b>Height</b> mm		380	600	760	
<b>Depth</b> mm		350	350	350	
Max. installation depth (T2) mm		310	310	310	
<b>Protection category</b> with gland plate for cable gland		IP 55 to IEC 60 529			
<b>Model No. DK</b>	1	<b>7641.000</b>	<b>7643.000</b>	<b>7645.000</b>	
<b>Product-specific supply scope</b>					
Mounting angles, 482.6 mm (19"), fully depth adjustable	2	■	■	■	
C rail, for cable clamping on the rear panel	1	■	■	■	
Metal bracket for optional accommodation of an earth rail or 482.6 mm (19") socket strip	1	■	■	■	
Cam locks	4	■ 1 x	■ 2 x	■ 2 x	
<b>Accessories</b>					
Gland plates in various versions	Size	5	5	5	514 – 518
	Qty.	1	1	1	
Wall mounting bracket, 10 mm	4	2508.010	2508.010	2508.010	439
Wall mounting bracket, 40 mm	4	2503.010	2503.010	2503.010	439
Wall mounting bracket for external mounting	4	2508.100	2508.100	2508.100	439
Viewing window, 34 mm profile depth	1	2730.000	2731.000	2732.000	408
Viewing window, 60 mm profile depth	1	2760.000	2761.000	2762.000	408
Component shelf 2 U, static installation, 250 mm deep	1	7119.250	7119.250	7119.250	487
Earth rail	1	7113.000	7113.000	7113.000	504
Alternative lock systems		see page 411			

■ Included with the supply.

# Wall-mounted enclosures AE



**System accessories** Page 355 **Socket strips** Page 505 **Captive nuts** Page 567 **Viewing panels** Page 407

## Material:

- Enclosure: Sheet steel
- Viewing window: Single-pane safety glass, 3 mm

## Surface finish:

- Enclosure: Powder-coated
- Pull-out frame: Stainless steel

## Colour:

RAL 7035

## Protection category:

See table.

## Supply includes:

- Enclosure with hinged door
- Cam lock and double-bit insert
- Gland plate with brush strip for cable entry in the enclosure base
- Product-specific supply scope, see table

## Detailed drawing:

Available on the Internet.

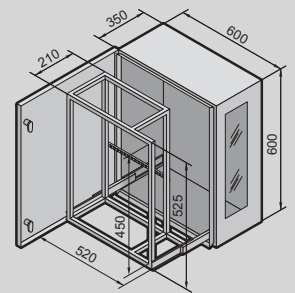

## With 482.6 mm (19") pull-out frame

Width mm	Packs of	600	Page
Height mm		600	
Depth mm		350	
L/h door hinge		■	
Cam locks		2	
Side installation, vertical		4 U	
Front installation, vertical and horizontal		10 U	
<b>Protection category</b> with gland plate for cable gland		IP 54 to IEC 60 529	
<b>Model No. DK</b>	1	<b>7644.000</b>	
<b>Product-specific supply scope</b>			
Pull-out frame attached to telescopic slides	1	■	
Outlet filter in enclosure base and on left-hand side	2	■	
Viewing window on right-hand side	1	■	
Cable clamp rail on rear wall	1	■	
Additional cable clamp rail for mounting on the pull-out frame		■	
<b>Accessories</b>			
Choice of gland plates	Size Qty.	5 1	514 – 518
Wall mounting bracket, 10 mm	4	2508.010	439
Wall mounting bracket for external mounting	4	2508.100	439
Wall mounting bracket, 40 mm	4	2503.010	439
Shelf	1	7644.400 <sup>1)</sup>	487
Component shelf, 1 U, 140 mm deep	1	7119.140	486
Earth rail, horizontal	1	7113.000	504
Fan expansion kit 230 V AC (only for use at the bottom)	1 set	7980.100	222
Fan expansion kit 48 V DC (only for use at the bottom)	1 set	7980.148	222
Spare filter mats	5	3322.700	301
Alternative lock systems		see page 411	

<sup>1)</sup> Extended delivery times.

# Small fibre-optic distributors



## System accessories Page 355

### Layout of the small fibre-optic distributor:

- Mounting plate with variable accommodation for up to two splicing cassettes (cassette width variable from 92 to 120 mm) and integral anti-twist guard
- Dividing plate with comb strip for cable clamping, to cover the splicing cassette, and to accommodate 2 patch panels and patch panels for F-SMA, E-2000 ST couplings, E-2000 duplex, SC couplings and SC duplex couplings

- Cable entry via cable glands in knockouts (12 x PG 7 and 1 x PG 16). Assembled connectors fit through the knockouts (diameter of cut-outs: 12 x 12.5 mm and 2 x 22.5 mm). Additional sealing inserts are required to reduce the clamping range of the cable glands

### Material:

- Enclosure and cover: Fibreglass-reinforced poly-carbonate
- Cover screws: Polyamide
- Insulating bungs: Polyamide
- Foamed-in PU seal

### Colour:

RAL 7035

### Protection category:

IP 66 to IEC 60 529

### Supply includes:

- Enclosure with knockouts for cable glands
- Hinged cover with seal
- 2 cover screws, prepared for a lead seal
- Insulating bungs for wall mounting
- Mounting plate
- Dividing plate
- 12 cable glands PG 7
- 1 cable gland PG 16

### Detailed drawing:

Available on the Internet.

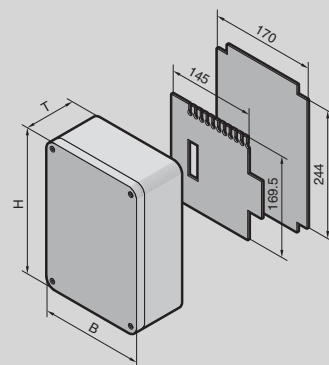

<b>Width (B) mm</b>	Packs of	180	Page
<b>Height (H) mm</b>		254	
<b>Depth (T) mm</b>		90	
Number of fibres (when using patch panels)		1 – 24	
<b>Model No. DK</b>	1	<b>7451.000</b>	

<b>Accessories</b>					
	Locations per patch panel	Locations per enclosure			
Patch panel for ST couplings	12	24	2	<b>7462.000</b>	
Patch panel for SC, E-2000, E-2000 duplex couplings	12/6	24/12	2	<b>7463.100</b>	
Patch panel for SC duplex couplings	6	12	2	<b>7463.200</b>	
Wall mounting brackets			40	9583.000	31

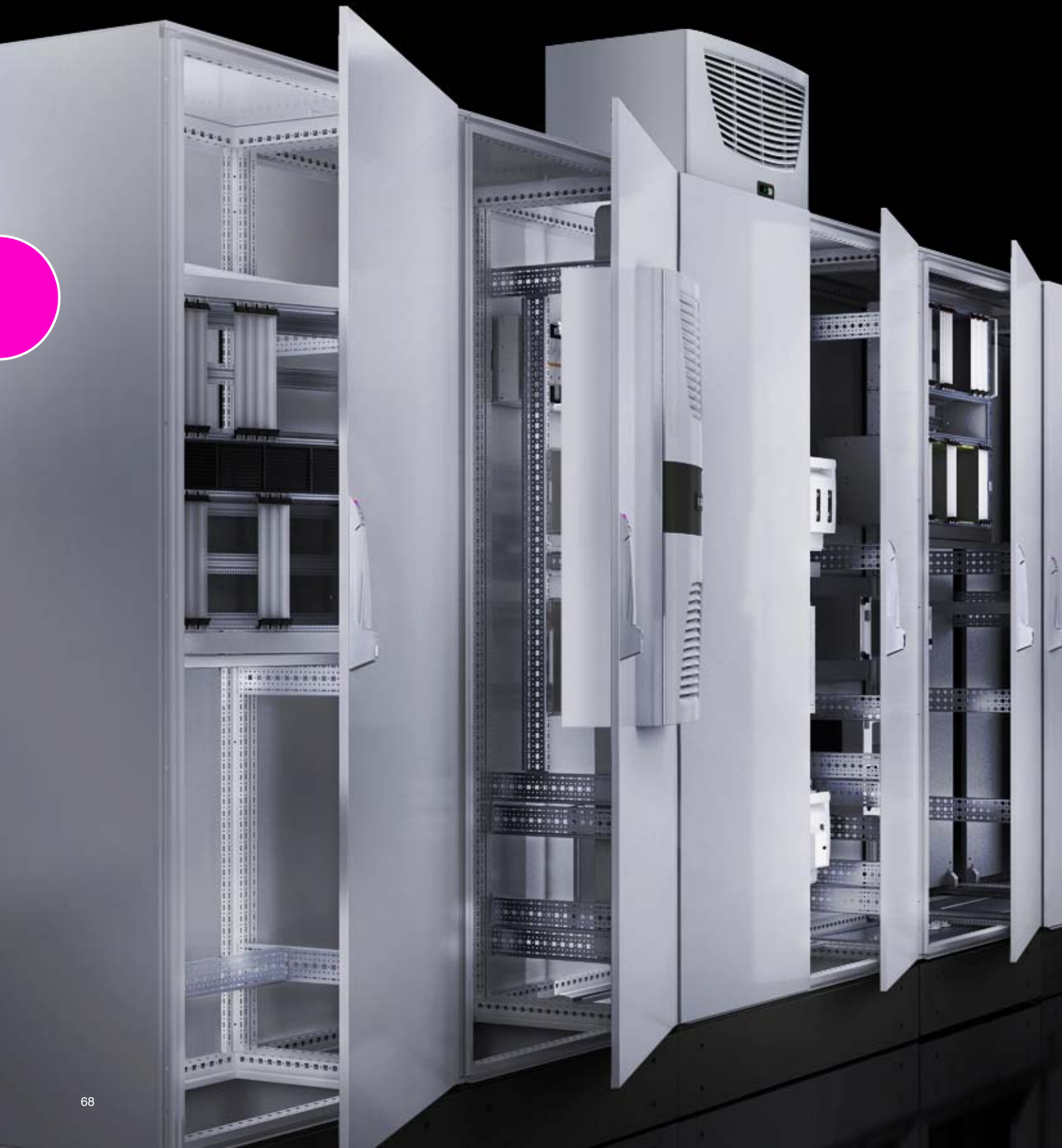

# Enclosure systems

---

## Baying systems TS 8

Height: 1200 mm/1400 mm, depth: 500 mm.....	70
Height: 1600 mm, depth: 500 mm.....	71
Height: 1800 mm, depth: 400 mm.....	71
Height: 1800 mm, depth: 500 mm.....	72
Height: 1800 mm, depth: 600 mm.....	72
Height: 2000 mm, depth: 400 mm.....	73
Height: 2000 mm, depth: 500 mm.....	73
Height: 2000 mm, depth: 600 mm.....	74
Height: 2000 mm, depth: 800 mm.....	74
Height: 2200 mm, depth: 600 mm.....	75
IP 66/NEMA 4X and IP 66/NEMA 4 .....	76
For areas at risk from earthquakes.....	77



# Baying systems TS 8



System accessories Page 355 TS 8 corner enclosures Page 401 TS 8 stainless steel Page 172

## Material:

- Enclosure frame, roof, rear panel and gland plates: Sheet steel, 1.5 mm
- Door: Sheet steel, 2.0 mm
- Mounting plate: Sheet steel, 3.0 mm

## Surface finish:

- Enclosure frame: Dipcoat-primed
- Door, roof and rear panel: Dipcoat-primed, powder-coated on the outside, textured paint
- Mounting plate and gland plates: Zinc-plated

## Colour:

RAL 7035

## Protection category:

IP 55 to IEC 60 529, complies with NEMA 12.

## Supply includes:

- Enclosure frame with door(s), 3 mm double-bit lock insert
- Mounting plate
- Gland plates
- Rear panel
- Roof plate
- 4 eyebolts

## Approvals:

- UL
- CSA
- TÜV
- Russian Maritime Register of Shipping
- TÜV Mark
- Lloyds Register of Shipping
- Bureau Veritas
- VDE
- Germanischer Lloyd

## Detailed drawings:

Available on the Internet.

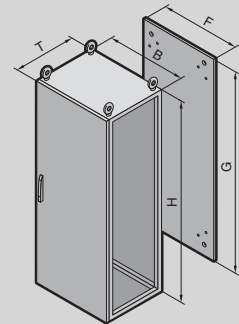

## Height: 1200 mm/1400 mm, depth: 500 mm

Width (B) mm	Packs of	600	800	1200	Page	
Height (H) mm		1400	1400	1400		
Depth (T) mm		500	500	500		
Mounting plate width (F) mm		499	699	1099		
Mounting plate height (G) mm		1296	1296	1296		
<b>Model No. TS</b>	1	<b>8645.500</b>	<b>8845.500</b>	<b>8245.500</b>		
Door(s)		1	1	2		
Weight (kg)		86.0	107.5	163.5		
<b>Walls</b>						
Side panels	2	8145.235	8145.235	8145.235	385	
<b>Base/plinths</b>						
Components front and rear	Height 100 mm	1 set	8601.600	8601.800	8601.200	361
	Height 200 mm	1 set	8602.600	8602.800	8602.200	361
Trim panels, sides	Height 100 mm	1 set	8601.050	8601.050	8601.050	362
	Height 200 mm	1 set	8602.050	8602.050	8602.050	362
Flex-Block			see page 358			
Levelling component for base/plinth			see page 364			
<b>Accessories</b>						
Cable clamp rails for cable clamps	2	4191.000	4192.000	4196.000	527	
Cable clamp rails (C section) for cable clamps	6	4944.000	4945.000	4947.000	465	
Section for cable entry, rear	1 set	8802.065	8802.085	8802.125 <sup>1)</sup>	513	
Support strips for door	20	4596.000	4598.000	4596.000	426	
Wiring plan pocket, sheet steel	1	4116.X00	4118.X00	4116.X00	429	
180° hinges	4	8800.190	8800.190	8800.190	425	
System lights			see page 491			
Door stay for escape routes	1	4583.500	4583.500	4583.500	429	
Earth straps			see page 501			
Alternative lock systems			see page 412			

<sup>1)</sup> Packs of 2 sets

# Baying systems TS 8

Height: 1600 mm, depth: 500 mm

Width (B) mm	Packs of	600	800	1200	Page	
Height (H) mm		1600	1600	1600		
Depth (T) mm		500	500	500		
Mounting plate width (F) mm		499	699	1099		
Mounting plate height (G) mm		1496	1496	1496		
<b>Model No. TS</b>	1	<b>8665.500</b>	<b>8865.500</b>	<b>8265.500</b>		
Door(s)		1	1	2		
Weight (kg)		100.0	103.0	159.3		
<b>Walls</b>						
Side panels	2	8165.235	8165.235	8165.235	385	
<b>Base/plinths</b>						
Components front and rear	Height 100 mm	1 set	8601.600	8601.800	8601.200	361
	Height 200 mm	1 set	8602.600	8602.800	8602.200	361
Trim panels, sides	Height 100 mm	1 set	8601.050	8601.050	8601.050	362
	Height 200 mm	1 set	8602.050	8602.050	8602.050	362
Flex-Block	see page 358					
Levelling component for base/plinth	see page 364					
<b>Accessories</b>						
Cable clamp rails for cable clamps	2	4191.000	4192.000	4196.000	527	
Cable clamp rails (C section) for cable clamps	6	4944.000	4945.000	4947.000	465	
Section for cable entry, rear	1 set	8802.065	8802.085	8802.125 <sup>1)</sup>	513	
Support strips for door	20	4596.000	4598.000	4596.000	426	
180° hinges	4	8800.190	8800.190	8800.190	425	
System lights	see page 491					
Door stay for escape routes	1	4583.500	4583.500	4583.500	429	
Earth straps	see page 501					
Alternative lock systems	see page 412					

<sup>1)</sup> Packs of 2 sets

Height: 1800 mm, depth: 400 mm

Width (B) mm	Packs of	600	800	1000	1000	1200	Page	
Height (H) mm		1800	1800	1800	1800	1800		
Depth (T) mm		400	400	400	400	400		
Mounting plate width (F) mm		499	699	899	899	1099		
Mounting plate height (G) mm		1696	1696	1696	1696	1696		
<b>Model No. TS</b>	1	<b>8684.500</b>	<b>8884.500</b>	<b>8084.500</b>	<b>8080.500</b>	<b>8284.500</b>		
Door(s)		1	1	1	2	2		
Weight (kg)		91.3	113.5	136.4	140.0	170.6		
<b>Walls</b>								
Side panels	2	8184.235	8184.235	8184.235	8184.235	8184.235	385	
Divider panel	1	8609.840	8609.840	8609.840	8609.840	8609.840	389	
<b>Doors</b>								
Glazed door	1	8610.680	8610.880	–	–	–	402	
<b>Base/plinths</b>								
Components front and rear	Height 100 mm	1 set	8601.600	8601.800	8601.000	8601.000	8601.200	361
	Height 200 mm	1 set	8602.600	8602.800	8602.000	8602.000	8602.200	361
Trim panels, sides	Height 100 mm	1 set	8601.040	8601.040	8601.040	8601.040	8601.040	362
	Height 200 mm	1 set	8602.040	8602.040	8602.040	8602.040	8602.040	362
Flex-Block	see page 358							
Levelling component for base/plinth	see page 364							
<b>Accessories</b>								
Cable clamp rails for cable clamps	2	4191.000	4192.000	4336.000	4336.000	4196.000	527	
Cable clamp rails (C section) for cable clamps	6	4944.000	4945.000	4946.000	4946.000	4947.000	465	
Section for cable entry, rear	1 set	8802.065	8802.085	8802.105 <sup>1)</sup>	8802.105 <sup>1)</sup>	8802.125 <sup>1)</sup>	513	
Support strips for door	20	4596.000	4598.000	4599.000	4309.000	4596.000	426	
Wiring plan pocket, sheet steel	1	4116.X00	4118.X00	4124.000	4115.X00	4116.X00	429	
180° hinges	4	8800.190	8800.190	8800.190	8800.190	8800.190	425	
System lights	see page 491							
Door stay for escape routes	1	4583.500	4583.500	4583.500	4583.500	4583.500	429	
Earth straps	see page 501							
Alternative lock systems	see page 412							

<sup>1)</sup> Packs of 2 sets

# Baying systems TS 8

Height: 1800 mm, depth: 500 mm

Width (B) mm	Packs of	600	800	800	1200	Page	
Height (H) mm		1800	1800	1800	1800		
Depth (T) mm		500	500	500	500		
Mounting plate width (F) mm		499	699	699	1099		
Mounting plate height (G) mm		1696	1696	1696	1696		
<b>Model No. TS</b>	1	<b>8685.500</b>	<b>8885.500</b>	<b>8880.500</b>	<b>8285.500</b>		
Door(s)		1	1	2	2		
Weight (kg)		93.8	115.8	122.5	173.3		
<b>Walls</b>							
Side panels	2	8185.235	8185.235	8185.235	8185.235	385	
Divider panel	1	8609.850	8609.850	8609.850	8609.850	389	
Divider panel for module plates	1	8609.100	8609.100	8609.100	8609.100	390	
<b>Doors</b>							
Glazed door	1	8610.680	8610.880	-	-	402	
<b>Base/plinths</b>							
Components front and rear	Height 100 mm	1 set	8601.600	8601.800	8601.800	8601.200	361
	Height 200 mm	1 set	8602.600	8602.800	8602.800	8602.200	361
Trim panels, sides	Height 100 mm	1 set	8601.050	8601.050	8601.050	8601.050	362
	Height 200 mm	1 set	8602.050	8602.050	8602.050	8602.050	362
Flex-Block	see page 358						
Levelling component for base/plinth	see page 364						
<b>Accessories</b>							
Mounting plate	1	-	-	-	-	451	
Cable clamp rails for cable clamps	2	4191.000	4192.000	4192.000	4196.000	527	
Cable clamp rails (C section) for cable clamps	6	4944.000	4945.000	4945.000	4947.000	465	
Section for cable entry, rear	1 set	8802.065	8802.085	8802.085	8802.125 <sup>1)</sup>	513	
Support strips for door	20	4596.000	4598.000	4594.000	4596.000	426	
180° hinges	4	8800.190	8800.190	8800.190	8800.190	425	
Door stay for escape routes	1	4583.500	4583.500	4583.500	4583.500	429	
Earth straps	see page 501						
Alternative lock systems	see page 412						

<sup>1)</sup> Packs of 2 sets

Height: 1800 mm, depth: 600 mm

Width (B) mm	Packs of	600	800	800	1200	Page	
Height (H) mm		1800	1800	1800	1800		
Depth (T) mm		600	600	600	600		
Mounting plate width (F) mm		499	699	699	1099		
Mounting plate height (G) mm		1696	1696	1696	1696		
<b>Model No. TS</b>	1	<b>8686.500</b>	<b>8886.500</b>	<b>8881.500</b>	<b>8286.500</b>		
Door(s)		1	1	2	2		
Weight (kg)		96.8	120.3	125.8	179.9		
Support strips fitted in the enclosure depth		■	■	■	■		
<b>Walls</b>							
Side panels	2	8186.235	8186.235	8186.235	8186.235	385	
Divider panel	1	8609.860	8609.860	8609.860	8609.860	389	
Divider panel for module plates	1	8609.110	8609.110	8609.110	8609.110	390	
<b>Doors</b>							
Glazed door	1	8610.680	8610.880	-	-	402	
<b>Base/plinths</b>							
Components front and rear	Height 100 mm	1 set	8601.600	8601.800	8601.800	8601.200	361
	Height 200 mm	1 set	8602.600	8602.800	8602.800	8602.200	361
Trim panels, sides	Height 100 mm	1 set	8601.060	8601.060	8601.060	8601.060	362
	Height 200 mm	1 set	8602.060	8602.060	8602.060	8602.060	362
Flex-Block	see page 358						
Levelling component for base/plinth	see page 364						
<b>Accessories</b>							
Mounting plate	1	-	-	-	-	451	
Cable clamp rails for cable clamps	2	4191.000	4192.000	4192.000	4196.000	527	
Cable clamp rails (C section) for cable clamps	6	4944.000	4945.000	4945.000	4947.000	465	
Section for cable entry, rear	1 set	8802.065	8802.085	8802.085	8802.125 <sup>1)</sup>	513	
Support strips for door	20	4596.000	4598.000	4594.000	4596.000	426	
180° hinges	4	8800.190	8800.190	8800.190	8800.190	425	
Door stay for escape routes	1	4583.500	4583.500	4583.500	4583.500	429	
Earth straps	see page 501						
Alternative lock systems	see page 412						

<sup>1)</sup> Packs of 2 sets



## Height: 2000 mm, depth: 400 mm

Width (B) mm	Packs of	600	800	1000	1200	Page	
Height (H) mm		2000	2000	2000	2000		
Depth (T) mm		400	400	400	400		
Mounting plate width (F) mm		499	699	899	1099		
Mounting plate height (G) mm		1896	1896	1896	1896		
<b>Model No. TS</b>	1	<b>8604.500</b>	<b>8804.500</b>	<b>8004.500</b>	<b>8204.500</b>		
Door(s)		1	1	2	2		
Weight (kg)		99.0	124.0	152.8	184.5		
<b>Walls</b>							
Side panels	2	8104.235	8104.235	8104.235	8104.235	385	
Divider panel	1	8609.040	8609.040	8609.040	8609.040	389	
<b>Doors</b>							
Glazed door	1	8610.600	8610.800	-	-	402	
<b>Base/plinths</b>							
Components front and rear	Height 100 mm	1 set	8601.600	8601.800	8601.000	8601.200	361
	Height 200 mm	1 set	8602.600	8602.800	8602.000	8602.200	361
Trim panels, sides	Height 100 mm	1 set	8601.040	8601.040	8601.040	8601.040	362
	Height 200 mm	1 set	8602.040	8602.040	8602.040	8602.040	362
Flex-Block				see page 358			
Levelling component for base/plinth				see page 364			
<b>Accessories</b>							
Cable clamp rails for cable clamps	2	4191.000	4192.000	4336.000	4196.000	527	
Cable clamp rails (C section) for cable clamps	6	4944.000	4945.000	4946.000	4947.000	465	
Section for cable entry, rear	1 set	8802.065	8802.085	8802.105 <sup>1)</sup>	8802.125 <sup>1)</sup>	513	
Support strips for door	20	4596.000	4598.000	4309.000	4596.000	426	
Wiring plan pocket, sheet steel	1	4116.X00	4118.X00	4115.X00	4116.X00	429	
180° hinges	4	8800.190	8800.190	8800.190	8800.190	425	
System lights				see page 491			
Door stay for escape routes	1	4583.500	4583.500	4583.500	4583.500	429	
Earth straps				see page 501			
Alternative lock systems				see page 412			

<sup>1)</sup> Packs of 2 sets

## Height: 2000 mm, depth: 500 mm

Width (B) mm	Packs of	600	800	1000	1200	Page	
Height (H) mm		2000	2000	2000	2000		
Depth (T) mm		500	500	500	500		
Mounting plate width (F) mm		499	699	899	1099		
Mounting plate height (G) mm		1896	1896	1896	1896		
<b>Model No. TS</b>	1	<b>8605.500</b>	<b>8805.500</b>	<b>8005.500</b>	<b>8205.500</b>		
Door(s)		1	1	2	2		
Weight (kg)		101.3	126.3	157.1	190.6		
<b>Walls</b>							
Side panels	2	8105.235	8105.235	8105.235	8105.235	385	
Divider panel	1	8609.050	8609.050	8609.050	8609.050	389	
Divider panel for module plates	1	8609.120	8609.120	8609.120	8609.120	390	
<b>Doors</b>							
Glazed door	1	8610.600	8610.800	-	-	402	
<b>Base/plinths</b>							
Components front and rear	Height 100 mm	1 set	8601.600	8601.800	8601.000	8601.200	361
	Height 200 mm	1 set	8602.600	8602.800	8602.000	8602.200	361
Trim panels, sides	Height 100 mm	1 set	8601.050	8601.050	8601.050	8601.050	362
	Height 200 mm	1 set	8602.050	8602.050	8602.050	8602.050	362
Flex-Block				see page 358			
Levelling component for base/plinth				see page 364			
<b>Accessories</b>							
Mounting plate	1	-	-	-	-	451	
Cable clamp rails for cable clamps	2	4191.000	4192.000	4336.000	4196.000	527	
Cable clamp rails (C section) for cable clamps	6	4944.000	4945.000	4946.000	4947.000	465	
Section for cable entry, rear	1 set	8802.065	8802.085	8802.105 <sup>1)</sup>	8802.125 <sup>1)</sup>	513	
Support strips for door	20	4596.000	4598.000	4309.000	4596.000	426	
Wiring plan pocket, sheet steel	1	4116.X00	4118.X00	4115.X00	4116.X00	429	
180° hinges	4	8800.190	8800.190	8800.190	8800.190	425	
System lights				see page 491			
Door stay for escape routes	1	4583.500	4583.500	4583.500	4583.500	429	
Earth straps				see page 501			
Alternative lock systems				see page 412			

<sup>1)</sup> Packs of 2 sets

# Baying systems TS 8

Height: 2000 mm, depth: 600 mm

Width (B) mm	Packs of	600	800	1000	1200	Page	
<b>Height (H) mm</b>		2000	2000	2000	2000		
<b>Depth (T) mm</b>		600	600	600	600		
Mounting plate width (F) mm		499	699	899	1099		
Mounting plate height (G) mm		1896	1896	1896	1896		
<b>Model No. TS</b>	1	<b>8606.500</b>	<b>8806.500</b>	<b>8006.500</b>	<b>8206.500</b>		
Door(s)		1	1	2	2		
Weight (kg)		104.0	130.5	161.2	194.6		
Support strips fitted in the enclosure depth		■	■	■	■		
<b>Walls</b>							
Side panels	2	8106.235	8106.235	8106.235	8106.235	385	
Divider panel	1	8609.060	8609.060	8609.060	8609.060	389	
Divider panel for module plates	1	8609.130	8609.130	8609.130	8609.130	390	
<b>Doors</b>							
Glazed door	1	8610.600	8610.800	–	–	402	
<b>Base/plinths</b>							
Components front and rear	Height 100 mm	1 set	8601.600	8601.800	8601.000	8601.200	361
	Height 200 mm	1 set	8602.600	8602.800	8602.000	8602.200	361
Trim panels, sides	Height 100 mm	1 set	8601.060	8601.060	8601.060	8601.060	362
	Height 200 mm	1 set	8602.060	8602.060	8602.060	8602.060	362
Flex-Block						see page 358	
Levelling component for base/plinth						see page 364	
<b>Accessories</b>							
Mounting plate	1	–	–	–	–	451	
Cable clamp rails for cable clamps	2	4191.000	4192.000	4336.000	4196.000	527	
Cable clamp rails (C section) for cable clamps	6	4944.000	4945.000	4946.000	4947.000	465	
Section for cable entry, rear	1 set	8802.065	8802.085	8802.105 <sup>1)</sup>	8802.125 <sup>1)</sup>	513	
Support strips for door	20	4596.000	4598.000	4309.000	4596.000	426	
180° hinges	4	8800.190	8800.190	8800.190	8800.190	425	
Door stay for escape routes	1	4583.500	4583.500	4583.500	4583.500	429	
Earth straps						see page 501	
Alternative lock systems						see page 412	

<sup>1)</sup> Packs of 2 sets

Height: 2000 mm, depth: 800 mm

Width (B) mm	Packs of	600	800	1200	Page	
<b>Height (H) mm</b>		2000	2000	2000		
<b>Depth (T) mm</b>		800	800	800		
Mounting plate width (F) mm		499	699	1099		
Mounting plate height (G) mm		1896	1896	1896		
<b>Model No. TS</b>	1	<b>8608.500</b>	<b>8808.500</b>	<b>8208.500</b>		
Door(s)		1	1	2		
Weight (kg)		111.3	137.0	203.0		
Support strips fitted in the enclosure depth		■	■	■		
<b>Walls</b>						
Side panels	2	8108.235	8108.235	8108.235	385	
Divider panel	1	8609.080	8609.080	8609.080	389	
<b>Doors</b>						
Glazed door	1	8610.600	8610.800	–	402	
<b>Base/plinths</b>						
Components front and rear	Height 100 mm	1 set	8601.600	8601.800	8601.200	361
	Height 200 mm	1 set	8602.600	8602.800	8602.200	361
Trim panels, sides	Height 100 mm	1 set	8601.080	8601.080	8601.080	362
	Height 200 mm	1 set	8602.080	8602.080	8602.080	362
Flex-Block					see page 358	
Levelling component for base/plinth					see page 364	
<b>Accessories</b>						
Cable clamp rails for cable clamps	2	4191.000	4192.000	4196.000	527	
Cable clamp rails (C section) for cable clamps	6	4944.000	4945.000	4947.000	465	
Section for cable entry, rear	1 set	8802.065	8802.085	8802.125 <sup>1)</sup>	513	
Support strips for door	20	4596.000	4598.000	4596.000	426	
180° hinges	4	8800.190	8800.190	8800.190	425	
Door stay for escape routes	1	4583.500	4583.500	4583.500	429	
Earth straps					see page 501	
Alternative lock systems					see page 412	

<sup>1)</sup> Packs of 2 sets

# Baying systems TS 8

Height: 2200 mm, depth: 600 mm

Width (B) mm	Packs of	600	800	1200	Page	
Height (H) mm		2200	2200	2200		
Depth (T) mm		600	600	600		
Mounting plate width (F) mm		499	699	1099		
Mounting plate height (G) mm		2096	2096	2096		
<b>Model No. TS</b>	1	<b>8626.500</b>	<b>8826.500</b>	<b>8226.500</b>		
Door(s)		1	1	2		
Weight (kg)		113.1	139.3	208.0		
Support strips fitted in the enclosure depth		■	■	■		
<b>Walls</b>						
Side panels	2	8126.235	8126.235	8126.235	385	
Divider panel	1	8609.260	8609.260	8609.260	389	
<b>Doors</b>						
Glazed door	1	8610.620	8610.820	–	402	
<b>Base/plinths</b>						
Components front and rear	Height 100 mm	1 set	8601.600	8601.800	8601.200	361
	Height 200 mm	1 set	8602.600	8602.800	8602.200	361
Trim panels, sides	Height 100 mm	1 set	8601.060	8601.060	8601.060	362
	Height 200 mm	1 set	8602.060	8602.060	8602.060	362
Flex-Block					see page 358	
Levelling component for base/plinth					see page 364	
<b>Accessories</b>						
Cable clamp rails for cable clamps	2	4191.000	4192.000	4196.000	527	
Cable clamp rails (C section) for cable clamps	6	4944.000	4945.000	4947.000	465	
Section for cable entry, rear	1 set	8802.065	8802.085	8802.125 <sup>1)</sup>	513	
Support strips for door	20	4596.000	4598.000	4596.000	426	
Wiring plan pocket, sheet steel	1	4116.X00	4118.X00	4116.X00	429	
180° hinges	4	8800.190	8800.190	8800.190	425	
System lights					see page 491	
Door stay for escape routes	1	4583.500	4583.500	4583.500	429	
Earth straps					see page 501	
Alternative lock systems					see page 412	

<sup>1)</sup> Packs of 2 sets



## Rittal France

RITTAL SAS  
 ZA des Grands Godets · 880 rue Marcel Paul  
 94507 Champigny sur Marne Cedex  
 Phone: +33 (0) 1 49 83 60 00  
 Fax: +33 (0) 1 49 83 82 06  
 E-mail: info@rittal.fr · www.rittal.fr

# Baying systems TS 8



System accessories Page 355 Cable entry Page 511

## Supply includes:

- Enclosure frame with door, 3 mm double-bit lock insert
- Roof plate
- Gland plate
- Rear panel
- Mounting plate
- 4 eyebolts

## Protection category:

See table.

## NEMA 4X:

### Material:

- Enclosure frame, roof, base, rear panel: Stainless steel 1.4301 (AISI 304), 1.5 mm
- Door: Stainless steel 1.4301 (AISI 304), 2.0 mm
- Mounting plate: Sheet steel, 3.0 mm

### Surface finish:

- Enclosure frame: Uncoated
- Door, roof, base, rear panel: Exterior brushed, grain size 400
- Mounting plate: Zinc-plated

## NEMA 4:

### Material:

- Enclosure frame, roof, base, rear panel: Sheet steel, spray-finished, 1.5 mm
- Door: Sheet steel, spray-finished, 2.0 mm
- Mounting plate: Sheet steel, 3.0 mm

### Surface finish:

- Enclosure frame, door, roof, base, rear panel: Dipcoat-primed and powder-coated on the outside, textured paint
- Mounting plate: Zinc-plated

## Colour:

RAL 7035

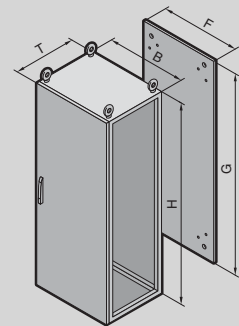

## IP 66/NEMA 4X and IP 66/NEMA 4

	Packs of	Stainless steel	Sheet steel	Page	
<b>Width (B) mm</b>		800	800		
<b>Height (H) mm</b>		2000	2000		
<b>Depth (T) mm</b>		600	600		
Mounting plate width (F) mm		699	699		
Mounting plate height (G) mm		1896	1896		
<b>Model No. TS</b>	1	<b>8450.680</b>	<b>8806.580</b>		
Door(s)		1	1		
<b>Protection category</b>		IP 66 to IEC 60 529, complies with NEMA 4X.	IP 66 to IEC 60 529, complies with NEMA 4.		
<b>Also required</b>					
Side panels IP 66/NEMA 4X, NEMA 4	2	<b>8700.680</b>	<b>8106.580</b>	–	
Baying frame IP 66/NEMA 4X, NEMA 4	1	<b>8700.010</b>	<b>8700.010</b>	–	
Quick-fit baying clamp, one-piece	6	8800.500	8800.500	395	
Baying clamp, horizontal	4	8800.400	8800.400	395	
Angular baying brackets	4	8800.430	8800.430	397	
<b>Base/plinths</b>					
Components front and rear	Height 100 mm	1 set	8701.800	8601.800	367/361
	Height 200 mm	1 set	8702.800	8602.800	367/361
Trim panels, sides	Height 100 mm	1 set	8701.060	8601.060	367/362
	Height 200 mm	1 set	8702.060	8602.060	367/362
Base/plinth trim, modular	4	2913.000	–	367	
<b>Accessories</b>					
Cable clamp rails	2	4192.000	4192.000	527	
Wiring plan pocket, sheet steel	1	4118.000	4118.000	429	
System light				see page 491	
Alternative lock systems				see page 412	

# Baying systems TS 8

## For areas at risk from earthquakes

### TS 8 for earthquake zone 1, 2 and 3 to Bellcore

TS 8806.500:  
W x H x D 800 x 2000 x 600 mm

With base/plinth (base/plinth components front and rear, see page 361 and base/plinth trim, side, see page 362), 100 mm high with a weight load of 152 kg spread evenly over the mounting plate.

#### Note:

These versions have been tested and meet the requirements to Telcordia GR 63-CORE. They should be seen as a comparative variable to the customer's own plant, since the certification of empty enclosures is not possible.

### TS 8 for earthquake zone 4 to Bellcore

TS 8806.500:  
W x H x D 800 x 2000 x 600 mm

Fitted with:

- Earthquake kit and
- Earthquake base/plinth, see page 77, with weight load of 450 kg distributed evenly over the mounting plate.

(Photo shows TS 8 for earthquake zone 4 to Bellcore)

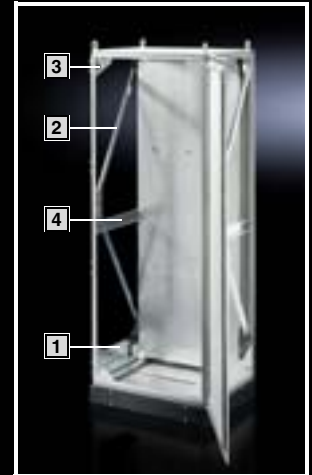

## Earthquake kit

#### Material:

Sheet steel

#### Surface finish:

Zinc-plated

#### Supply includes:

- 1** 2 side reinforcements, bottom
- 2** 2 bracing struts each, sides
- 3** 8 gusset plates
- 4** Mounting plate attachment and reinforcement including assembly parts

For enclosures W x H x D mm	Packs of	Model No. TS
800 x 2000 x 600	1	<b>8613.860</b>
600 x 2000 x 600	1	<b>8613.660<sup>1)</sup></b>
600 x 2000 x 400	1	<b>8613.640<sup>1)</sup></b>

<sup>1)</sup> Extended delivery times.

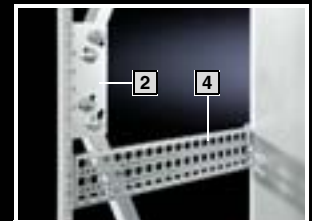
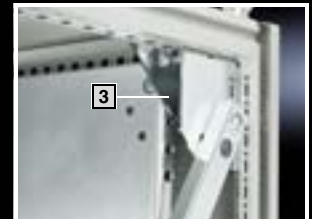

## Earthquake base/plinth

Height 100 mm

#### Material:

- Corner pieces: Sheet steel 5 mm
- Trim panels: Sheet steel 2 mm

#### Surface finish:

Powder-coated

#### Colour:

RAL 7022

#### Supply includes:

- 1 set =
- 4 corner pieces
- 2 depth stays
- 1 trim panel each front and rear fully assembled.

For enclosures W x D mm	Packs of	Model No. TS
800 x 600	1	<b>8601.860</b>
600 x 600	1	<b>8601.660<sup>1)</sup></b>
600 x 400	1	<b>8601.640<sup>1)</sup></b>

<sup>1)</sup> Extended delivery times.



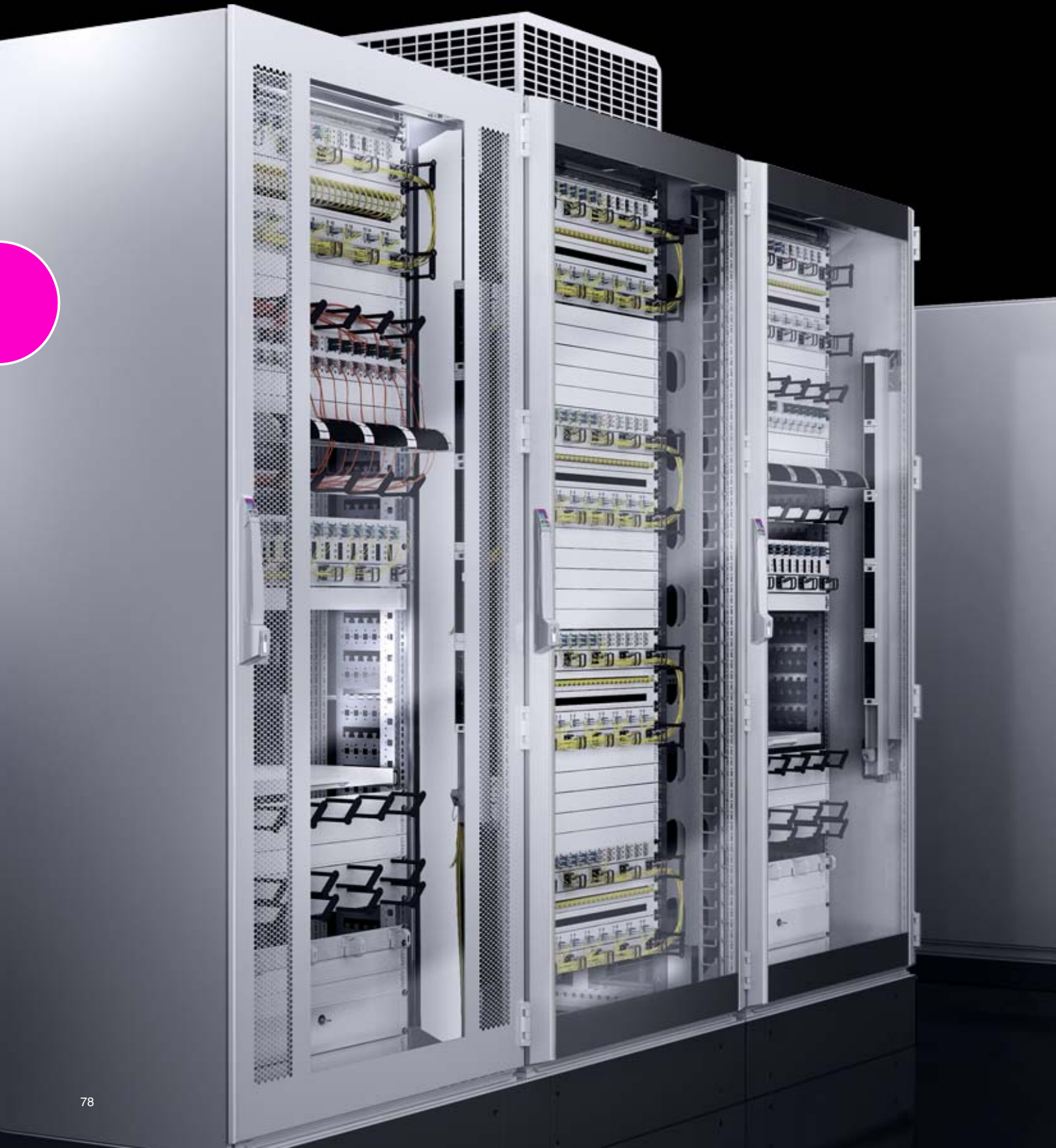

# Network distribution enclosures

## Network enclosures TS 8

Pre-configured, doors unvented .....	80
Pre-configured, doors unvented/vented .....	81
Pre-configured, doors/rear wall unvented .....	82
Pre-configured, doors unvented, divided .....	82
Network enclosures TS 8.....	83

## Network enclosures TE 7000

Pre-configured.....	85
600 mm width .....	86
800 mm width .....	87

## Distributor racks

TE 7000 open .....	88
Data Rack .....	89



# Network enclosures TS 8



System accessories Page 355 Power System Module Page 201 Monitoring Page 577 Climate control Page 207

## Material:

- Enclosure: Sheet steel
- Glazed door: Single-pane safety glass, 3 mm

## Surface finish:

- Enclosure frame: Dipcoat-primed
- Doors and roof: Dipcoat-primed, powder-coated
- Gland plates, punched sections with mounting flanges and mounting angles: Zinc-plated

## Colour:

RAL 7035

## Supply includes:

Product-specific supply scope, see table.

## Detailed drawing:

Available on the Internet.

Photo shows a configuration example with equipment not included in the scope of supply.

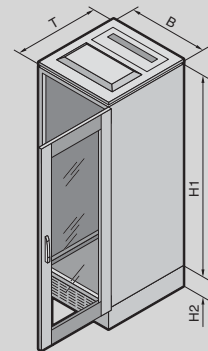

## Pre-configured, doors unvented

U	Packs of	24	24	38	42
<b>Width (B) mm</b>		600	800	800	800
<b>Height (H1 + H2) mm</b>		1200 + 100	1200 + 100	1800 + 100	2000 + 100
<b>Depth (T) mm</b>		600	800	800	800
Distance between levels, pre-configured mm		–	498	498	498
Glazed aluminium door at the front, 180°, with comfort handle for semi-cylinder and security lock 3524 E	1	■	■	■	■
Sheet steel door at the rear, 130°, with handle and security lock 3524 E	1	■	■	■	■
482.6 mm (19") mounting level at the front and rear, cranked mounting angles screw-fastened onto installation brackets approx. 150 mm behind the front edge of the frame, depth-variable		–	■	■	■
482.6 mm (19") mounting angle at the front, cranked mounting angle screw-fastened to TS punched sections with mounting flanges as support strips		■	–	–	–
Gland plate mounted at front as infill panel	1	–	■	■	■
Gland plate, one-piece, vented, with cable entry	1	■	–	–	–
Roof plate for cable entry, two-piece	1	■	■	■	■
Including side panels	2	■	■	–	■
<b>Model No. DK</b>	1	<b>7830.100</b>	<b>7830.110</b>	<b>7830.850</b>	<b>7830.200</b>
<b>Supply includes</b>					
Baying kit TS 8800.500	1 set	–	–	■	–
Base/plinth vented, 100 mm high	1	■	■	■	■
Earthing of all enclosure panels pre-configured	1 set	■	■	■	■
Levelling feet (incl. base/plinth adaptor)	4	■	■	■	■
Spacers for raising the roof	4	■	■	■	■
Cable clamp rails for the inner frame level	4	■	■	■	■
Cable shunting rings, plastic	10	■	■	■	■
Captive nuts M6, conductive	50	■	■	■	■
Multi-tooth screws M6	50	■	■	■	■
<b>Accessories</b>					
Side panel, lockable, see page 387	2	–	–	7824.188	–

■ Included with the supply.



# Network enclosures TS 8

## Pre-configured, doors unvented

U	Packs of	42	42	42	42	47
Width (B) mm		800	800	800	800	800
Height (H1 + H2) mm		2000 + 100	2000 + 100	2000 + 100	2000 + 100	2200 + 100
Depth (T) mm		800	800	1000	1000	800
Distance between levels, pre-configured mm		498	498	498	498	498
Glazed aluminium door at the front, 180°, with comfort handle for semi-cylinder and security lock 3524 E	1	■	■	■	■	■
Sheet steel door at the rear, 130°, with handle and security lock 3524 E	1	■	■	■	■	■
482.6 mm (19") mounting level at the front and rear, cranked mounting angles screw-fastened onto installation brackets approx. 150 mm behind the front edge of the frame, depth-variable		■	■	■	■	■
Gland plate mounted at front as infill panel	1	■	■	■	■	■
Roof plate for cable entry, two-piece	1	■	■	■	■	■
Including side panels	2	–	■	■	–	–
<b>Model No. DK</b>	1	<b>7830.250</b>	<b>7830.202</b>	<b>7830.230</b>	<b>7830.240</b>	<b>7830.270</b>
<b>Supply includes</b>						
Baying kit TS 8800.500	1 set	■	–	–	■	■
Base/plinth vented, 100 mm high	1	■	■	■	■	■
Earthing of all enclosure panels pre-configured	1 set	■	■	■	■	■
Levelling feet (incl. base/plinth adaptor)	4	■	■	■	■	■
Spacers for raising the roof	4	■	■	■	■	■
Cable clamp rails for the inner frame level	4	■	■	■	■	■
Cable shunting rings, plastic	10	■	■	■	■	■
Captive nuts M6, conductive	50	■	■	■	■	■
Multi-tooth screws M6	50	■	■	■	■	■
Also included: Compact light (8 W), mounting kit (magnetic), 482.6 mm (19") socket strip, 7-way (earthing-pin), door-operated switch, junction box incl. connection accessories, 482.6 mm (19") component shelf (500 mm) incl. mounting accessories		–	■	–	–	–
<b>Accessories</b>						
Side panel, lockable, see page 387	2	7824.208	–	–	7824.200	7824.228

■ Included with the supply.

## Pre-configured, doors vented

U	Packs of	24	42	42	47
Width (B) mm		800	800	800	800
Height (H1 + H2) mm		1200 + 100	2000 + 100	2000 + 100	2200 + 100
Depth (T) mm		1000	1000	1000	1000
Distance between levels, pre-configured mm		740	740	740	740
Glazed sheet steel door at the front, 180°, with comfort handle for semi-cylinder and security lock 3524 E	1	■	■	■	■
Vented sheet steel door at the rear, 180°, with handle and security lock 3524 E	1	■	■	■	■
482.6 mm (19") mounting level at the front and rear, L-shaped mounting angles screw-fastened onto 2 or 3 support strips, depth-variable		■	■	■	■
Gland plate, one-piece, vented, with cable entry	1	■	■	■	■
Roof plate for cable entry, two-piece	1	■	■	■	■
Including side panels	2	■	■	–	–
<b>Model No. DK</b>	1	<b>7830.130</b>	<b>7830.330</b>	<b>7830.335</b>	<b>7830.380<sup>1)</sup></b>
<b>Supply includes</b>					
Baying kit TS 8800.500	1 set	–	–	■	■
Base/plinth vented, 100 mm high	1	■	■	■	■
Earthing of all enclosure panels pre-configured	1 set	■	■	■	■
Levelling feet (incl. base/plinth adaptor)	4	■	■	■	■
Spacers for raising the roof	4	■	■	■	■
Cable clamp rails for the inner frame level	4	■	■	■	■
Cable shunting rings, plastic	10	■	■	■	■
Captive nuts M6, conductive	50	■	■	■	■
Multi-tooth screws M6	50	■	■	■	■
<b>Accessories</b>					
Side panel, lockable, see page 387	2	–	–	7824.200	7824.220

■ Included with the supply. <sup>1)</sup> Extended delivery times.

# Network enclosures TS 8

## Pre-configured, doors/rear wall unvented

U	Packs of	42	40
<b>Width</b> (B) mm		800	800
<b>Height</b> (H1 + H2 + H3) mm		2000 + 100 + 25	2000 + 100 + 25
<b>Depth</b> (T) mm		800	800
Distance between levels, pre-configured mm		498	–
Glazed aluminium door at the front, 180°, with comfort handle for semi-cylinder and security lock 3524 E	1	■	■
Sheet steel door at the rear, 130°, with handle and security lock 3524 E	1	■	–
Sheet steel rear panel	1	–	■
482.6 mm (19") mounting level at the front and rear, L-shaped mounting angles screw-fastened onto support strips, depth-variable		■	–
Swing frame, large, with side trim panel for the installation of 482.6 mm (19") mounting components whilst utilising the full enclosure height (130°, 150 kg static load capacity)		–	■
Gland plate, one-piece, vented, with cable entry	1	–	■
Gland plate mounted at front as infill panel	1	■	–
Roof plate with cut-out for fan insert and vent panel on spacers	1	■	■
Including side panels	2	–	–
<b>Model No. DK</b>	1	<b>7830.550</b>	<b>7830.670</b>
<b>Supply includes</b>			
Baying kit TS 8800.500	1 set	■	■
Base/plinth vented, 100 mm high	1	■	■
Earthing of all enclosure panels pre-configured	1 set	■	■
Levelling feet (incl. base/plinth adaptor)	4	■	■
Spacers for raising the roof	4	■	■
Cable clamp rails for the inner frame level	4	■	■
Cable shunting rings, plastic	10	■	■
Captive nuts M6, conductive	50	■	■
Multi-tooth screws M6	50	■	■
<b>Accessories</b>			
Side panel, lockable, see page 387	2	7824.208	7824.208

■ Included with the supply.

## Pre-configured, doors unvented, divided

U	Packs of	42	
<b>Width</b> (B) mm		800	
<b>Height</b> (H1 + H2) mm		2000 + 100	
<b>Depth</b> (T) mm		800	
Distance between levels, pre-configured mm		498	
Glazed sheet steel door at front, vertically divided, 180°	1	■	
Sheet steel door at rear, vertically divided, 180°	1	■	
482.6 mm (19") mounting level at the front and rear, cranked mounting angles screw-fastened onto installation brackets approx. 150 mm behind the front edge of the frame, depth-variable		■	
Gland plate mounted at front as infill panel	1	■	
Roof plate for cable entry, two-piece, with cut-out for fan insert and vent panel on spacers	1	■	
Including side panels	2	–	
<b>Model No. DK</b>	1	<b>7830.260</b>	
<b>Supply includes</b>			
Baying kit TS 8800.500	1 set	■	
Base/plinth vented, 100 mm high	1	■	
Earthing of all enclosure panels pre-configured	1 set	■	
Levelling feet (incl. base/plinth adaptor)	4	■	
Spacers for raising the roof	4	■	
Cable clamp rails for the inner frame level	4	■	
Cable shunting rings, plastic	10	■	
Captive nuts M6, conductive	50	■	
Multi-tooth screws M6	50	■	
<b>Accessories</b>			
Side panel, lockable, see page 387	2	7824.208	

■ Included with the supply.

# Network enclosures TS 8



System accessories Page 355 Power System Module Page 201 Monitoring Page 577 Climate control Page 207

#### Material:

- Sheet steel
- Glazed door: Single-pane safety glass, 3 mm

#### Surface finish:

- Enclosure frame: Dipcoat-primed
- Doors and roof: Dipcoat-primed, powder-coated
- Base plates and punched sections with mounting flanges: Zinc-plated

#### Colour:

RAL 7035

#### Protection category:

IP 55 to IEC 60 529 in connection with side panels, screw-fastened

#### Supply includes:

Product-specific supply scope, see table.

#### Approvals:

- UL
- cUL

#### Detailed drawing:

Available on the Internet.

Photo shows a configuration example with equipment not included in the scope of supply.

U	15	15	20	20	24	24	24	24
Width mm	600	600	600	600	600	600	800	800
Height mm	800	800	1000	1000	1200	1200	1200	1200
Depth mm	600	600	600	600	600	600	600	600
Model No. DK	7820.100	7821.100	7820.200	7821.200	7820.300	7821.300	7820.340 <sup>1)</sup>	7821.340

#### Supply includes

Glazed aluminium door at the front (180°), with comfort handle for semi-cylinder and security lock 3524 E	■	-	■	-	■	-	■	-
Sheet steel door at the front (180°), with comfort handle for semi-cylinder and security lock 3524 E	-	■	-	■	-	■	-	■
Sheet steel door at the rear (130°), with handle and security lock 3524 E	■	■	■	■	■	■	■	■
Gland plate, multi-piece, solid	■	■	■	■	■	■	■	■
Roof plate, solid	■	■	■	■	■	■	■	■
Base/plinths	see page 360							

U	24	29	29	33	33	33	33
Width mm	800	600	600	600	600	600	600
Height mm	1200	1400	1400	1600	1600	1600	1600
Depth mm	800	800	800	600	600	800	800
Model No. DK	7820.350	7820.410	7821.410	7820.500	7821.500	7820.510	7821.510

#### Supply includes

Glazed aluminium door at the front (180°), with comfort handle for semi-cylinder and security lock 3524 E	■	■	-	■	-	■	-
Sheet steel door at the front (180°), with comfort handle for semi-cylinder and security lock 3524 E	-	-	■	-	■	-	■
Sheet steel door at the rear (130°), with handle and security lock 3524 E	■	■	■	■	■	■	■
Gland plate, multi-piece, solid	■	■	■	■	■	■	■
Roof plate, solid	■	■	■	■	■	■	■
Base/plinths	see page 360						

■ Included with the supply. <sup>1)</sup> Extended delivery times.

# Network enclosures TS 8

<b>U</b>	38	38	38	38	38	38
<b>Width mm</b>	600	600	600	600	800	800
<b>Height mm</b>	1800	1800	1800	1800	1800	1800
<b>Depth mm</b>	600	600	800	800	800	800
<b>Model No. DK</b>	<b>7820.600</b>	<b>7821.600</b>	<b>7820.610</b>	<b>7821.610</b>	<b>7820.650</b>	<b>7821.650</b>

<b>Supply includes</b>						
Glazed aluminium door at the front (180°), with comfort handle for semi-cylinder and security lock 3524 E	■	-	■	-	■	-
Sheet steel door at the front (180°), with comfort handle for semi-cylinder and security lock 3524 E	-	■	-	■	-	■
Sheet steel door at the rear (130°), with handle and security lock 3524 E	■	■	■	■	■	■
Gland plate, multi-piece, solid	■	■	■	■	■	■
Roof plate, solid	■	■	■	■	■	■
Base/plinths	see page 360					

<b>U</b>	42	42	42	42	42	42
<b>Width mm</b>	600	600	600	600	600	600
<b>Height mm</b>	2000	2000	2000	2000	2000	2000
<b>Depth mm</b>	600	600	800	800	1000	1000
<b>Model No. DK</b>	<b>7820.700</b>	<b>7821.700</b>	<b>7820.710</b>	<b>7821.710</b>	<b>7820.730</b>	<b>7821.730</b>

<b>Supply includes</b>						
Glazed aluminium door at the front (180°), with comfort handle for semi-cylinder and security lock 3524 E	■	-	■	-	■	-
Sheet steel door at the front (180°), with comfort handle for semi-cylinder and security lock 3524 E	-	■	-	■	-	■
Sheet steel door at the rear (130°), with handle and security lock 3524 E	■	■	■	■	■	■
Gland plate, multi-piece, solid	■	■	■	■	■	■
Roof plate, solid	■	■	■	■	■	■
Base/plinths	see page 360					

<b>U</b>	42	42	42	42	42	42
<b>Width mm</b>	800	800	800	800	800	800
<b>Height mm</b>	2000	2000	2000	2000	2000	2000
<b>Depth mm</b>	600	600	800	800	1000	1000
<b>Model No. DK</b>	<b>7820.740</b>	<b>7821.740</b>	<b>7820.750</b>	<b>7821.750</b>	<b>7820.770</b>	<b>7821.770</b>

<b>Supply includes</b>						
Glazed aluminium door at the front (180°), with comfort handle for semi-cylinder and security lock 3524 E	■	-	■	-	■	-
Sheet steel door at the front (180°), with comfort handle for semi-cylinder and security lock 3524 E	-	■	-	■	-	■
Sheet steel door at the rear (130°), with handle and security lock 3524 E	■	■	■	■	■	■
Gland plate, multi-piece, solid	■	■	■	■	■	■
Roof plate, solid	■	■	■	■	■	■
Base/plinths	see page 360					

<b>U</b>	47	47	47	47	47	47
<b>Width mm</b>	600	600	600	600	800	800
<b>Height mm</b>	2200	2200	2200	2200	2200	2200
<b>Depth mm</b>	600	600	800	800	800	800
<b>Model No. DK</b>	<b>7820.800</b>	<b>7821.800</b>	<b>7820.810</b>	<b>7821.810</b>	<b>7820.850</b>	<b>7821.850</b>

<b>Supply includes</b>						
Glazed aluminium door at the front (180°), with comfort handle for semi-cylinder and security lock 3524 E	■	-	■	-	■	-
Sheet steel door at the front (180°), with comfort handle for semi-cylinder and security lock 3524 E	-	■	-	■	-	■
Sheet steel door at the rear (130°), with handle and security lock 3524 E	■	■	■	■	■	■
Gland plate, multi-piece, solid	■	■	■	■	■	■
Roof plate, solid	■	■	■	■	■	■
Base/plinths	see page 360					

■ Included with the supply.

# Network enclosures TE 7000



**System accessories** Page 355 **Power System Module** Page 201 **Monitoring** Page 577 **Climate control** Page 207

## Benefits:

- No frame structure
- Optimum accessibility
- Readily dismantled and therefore easily installed

## Material:

- Sheet steel
- Glazed door: Single-pane safety glass, 4 mm

## Surface finish:

- Mounting frame: Dipcoat-primed
- Enclosure panels: Powder-coated

**Colour:**  
RAL 7035

## Supply includes:

Product-specific supply scope, see table.

## Detailed drawing:

Available on the Internet.

## Pre-configured

U	Packs of	24	42	42	Page
Width mm		800	800	800	
Height (enclosure + base/plinth) mm		1200 + 100	2000 + 100	2000 + 100	
Depth mm		800	800	800	
Distance between levels, pre-configured mm		495	495	495	
<b>Model No. TE</b>	1	<b>7000.840</b>	<b>7000.850</b>	<b>7000.852</b>	

### Supply includes

Self-supporting 482.6 mm (19") mounting frame, front and rear, depth-variable	2	■	■	■	
Glazed door at the front, incl. 130° hinge, recessed handle and security lock 3524 E	1	■	■	■	
Sheet steel door at the rear, including 130° hinge, security lock 3524 E	1	■	■	■	
Side panels, lockable, including security lock 3524 E	2	■	■	7000.652	388
Base frame with maximum cut-out (for optional population with module plates)	1	■	■	■	
Roof plate including brush strip for cable entry and concealed cut-out for optional fan	1	■	■	■	
Levelling feet (including base/plinth adaptor) supplied loose	4	■	■	■	
Spacers, 20 mm, supplied loose to raise the roof	4	■	■	■	
Base/plinth 100 mm, vented	1	■	■	■	
Tested frame earthing to IEC 60 950, fitted		■	■	■	
C rails, for cable clamping in the enclosure depth via cable clamps, supplied loose	4	■	■	■	
Cable shunting rings made of plastic, 105 x 70 mm, supplied loose	10	■	■	■	
Captive nuts M6, conductive	50	■	■	■	
Multi-tooth screw M6, with plastic washers	50	■	■	■	

### Accessories

Baying kit	1 set	7000.640	7000.640	■	400
Ergoform-S handle for semi-cylinder, to exchange for the existing lock	1	2435.000	2435.000	2435.000	419
Fan unit, with 2 fans and thermostat, pre-wired ready for connection	1	7000.670	7000.670	7000.670	224
Slide rail for TE, for attachment between the 482.6 mm (19") mounting frames, length 424 mm	2	7963.410	7963.410	7963.410	560
482.6 mm (19") component shelf for static installation, for direct screw fastening without an installation kit, 413 mm deep, load capacity 30 kg, static	1	7000.620	7000.620	7000.620	483
482.6 mm (19") component shelf, complete set, pull-out, 500 mm deep, load capacity 50 kg static	1 set	7000.625	7000.625	7000.625	486
Socket strip, 8-way	1	7000.630	7000.630	7000.630	506
Transport castors (only without base/plinth)	4	7000.672	7000.672	7000.672	375

■ Included with the supply.

# Network enclosures TE 7000



System accessories Page 355 Power System Module Page 201 Monitoring Page 577 Climate control Page 207

### Benefits:

- No frame structure
- Optimum accessibility
- Readily dismantled and therefore easily installed

### Material:

- Sheet steel
- Glazed door: Single-pane safety glass, 4 mm

### Surface finish:

- Mounting frame: Dipcoat-primed
- Enclosure panels: Powder-coated

### Colour:

RAL 7035

### Supply includes:

Product-specific supply scope, see table.

### Detailed drawing:

Available on the Internet.

## 600 mm width

U	Packs of	11	11	24	24	42	42	47	47	Page
Width mm		600	600	600	600	600	600	600	600	
Height mm		600	600	1200	1200	2000	2000	2200	2200	
Depth mm		600	800	600	800	600	800	600	800	
Distance between levels, pre-configured mm		495	495	495	495	495	495	495	495	
Model No. TE	1	7000.390	7000.410	7000.430	7000.440	7000.500	7000.510	7000.560 <sup>1)</sup>	7000.570 <sup>1)</sup>	

### Supply includes

Self-supporting 482.6 mm (19") mounting frame, front and rear, depth-variable	2	■	■	■	■	■	■	■	■	
Glazed door at the front, incl. 130° hinge, recessed handle and security lock 3524 E	1	■	■	■	■	■	■	■	■	
Sheet steel door at the rear, including 130° hinge, security lock 3524 E	1	■	■	■	■	■	■	■	■	
Side panels, lockable, including security lock 3524 E	2	■	■	■	■	■	■	■	■	
Base frame with maximum cut-out (for optional population with module plates)	1	■	■	■	■	■	■	■	■	
Roof plate including brush strip for cable entry and concealed cut-out for optional fan	1	■	■	■	■	■	■	■	■	
Levelling feet, M10, supplied loose	4	■	■	■	■	■	■	■	■	
Spacers, 20 mm, supplied loose to raise the roof	4	■	■	■	■	■	■	■	■	

### Accessories

Base/plinth components, front and rear, vented	1 set	7825.601	7825.601	7825.601	7825.601	7825.601	7825.601	7825.601	7825.601	361
Base/plinth trim panels, side	1 set	8601.065	8601.085	8601.065	8601.085	8601.065	8601.085	8601.065	8601.085	362
Baying kit	4	7000.640	7000.640	7000.640	7000.640	7000.640	7000.640	7000.640	7000.640	400
Fan unit, with 2 fans and thermostat, pre-wired ready for connection	1	7000.670	7000.670	7000.670	7000.670	7000.670	7000.670	7000.670	7000.670	224
Earthing kit	1 set	7000.675	7000.675	7000.675	7000.675	7000.675	7000.675	7000.675	7000.675	503
Socket strip, 8-way	1	7000.630	7000.630	7000.630	7000.630	7000.630	7000.630	7000.630	7000.630	506
482.6 mm (19") component shelf, complete set, pull-out, 500 mm deep, load capacity 50 kg static	1 set	7000.625	7000.625	7000.625	7000.625	7000.625	7000.625	7000.625	7000.625	486
Transport castors (only without base/plinth)	4	7000.672	7000.672	7000.672	7000.672	7000.672	7000.672	7000.672	7000.672	375

■ Included with the supply. <sup>1)</sup> Extended delivery times.

# Network enclosures TE 7000

## 800 mm width

U	Packs of	24	24	42	42	42	47	47	47	Page
Width mm		800	800	800	800	800	800	800	800	
Height mm		1200	1200	2000	2000	2000	2200	2200	2200	
Depth mm		600	800	600	800	800	600	800	800	
Distance between levels, pre-configured mm		495	495	495	495	495	495	495	495	
<b>Model No. TE</b>	1	<b>7000.450<sup>1)</sup></b>	<b>7000.460</b>	<b>7000.520</b>	<b>7000.530</b>	<b>7000.532</b>	<b>7000.580<sup>1)</sup></b>	<b>7000.590</b>	<b>7000.592<sup>1)</sup></b>	

### Supply includes

Self-supporting 482.6 mm (19") mounting frame, front and rear, depth-variable	2	■	■	■	■	■	■	■	■	
Glazed door at the front, incl. 130° hinge, recessed handle and security lock 3524 E	1	■	■	■	■	■	■	■	■	
Sheet steel door at the rear, including 130° hinge, security lock 3524 E	1	■	■	■	■	■	■	■	■	
Side panels, lockable, including security lock 3524 E	2	■	■	■	■	-	■	■	■	
Base frame with maximum cut-out (for optional population with module plates)	1	■	■	■	■	■	■	■	■	
Roof plate including brush strip for cable entry and concealed cut-out for optional fan	1	■	■	■	■	■	■	■	■	
Levelling feet (including base/plinth adaptor) supplied loose	4	■	■	■	■	■	■	■	■	
Spacers, 20 mm, supplied loose to raise the roof	4	■	■	■	■	■	■	■	■	

### Accessories

Base/plinth components, front and rear, vented	1 set	7825.801	7825.801	7825.801	7825.801	7825.801	7825.801	7825.801	7825.801	361
Base/plinth trim panels, side	1 set	8601.065	8601.085	8601.065	8601.085	8601.085	8601.065	8601.085	8601.085	362
Baying kit	4	7000.640	7000.640	7000.640	7000.640	■	7000.640	7000.640	■	400
Fan module, with 2 fans and thermostat, pre-wired ready for connection	1	7000.670	7000.670	7000.670	7000.670	7000.670	7000.670	7000.670	7000.670	224
Earthing kit	1 set	7000.675	7000.675	7000.675	7000.675	7000.675	7000.675	7000.675	7000.675	503
Socket strip, 8-way	1	7000.630	7000.630	7000.630	7000.630	7000.630	7000.630	7000.630	7000.630	506
482.6 mm (19") component shelf, complete set, pull-out, 500 mm deep, load capacity 50 kg static	1 set	7000.625	7000.625	7000.625	7000.625	7000.625	7000.625	7000.625	7000.625	486
Transport castors (only without base/plinth)	4	7000.672	7000.672	7000.672	7000.672	7000.672	7000.672	7000.672	7000.672	375

■ Included with the supply. <sup>1)</sup> Extended delivery times.



## Rittal Norway

RITTAL AS  
 Postboks 258 · N-1401 Ski  
 Phone: +47 64 85 13 00 · Fax: +47 64 85 13 01  
 Besøksadresse: Regnbueveien 10  
 N-1405 Langhus  
 E-mail: rittal@rittal.no · www.rittal.no

# Distributor racks



482.6 mm (19") installation system Page 559 Monitoring Page 577 Power System Module Page 201

## Benefits:

- Optimum accessibility from all sides during assembly and installation.
- Unrestricted airflow, due to the open design.
- Standard cable trays in the roof area for larger quantities of cables.
- The distance between attachment levels is infinitely variable.

## Material:

Sheet steel

## Colour:

RAL 7035

## Surface finish:

Powder-coated

## Load capacity:

700 kg, static

## Supply includes:

- Self-supporting mounting frame, with 482.6 mm (19") mounting level front and rear
- Open roof frame for cable entry
- 3 cable routing trays
- Open base frame with 2 punched sections with mounting flanges for individual configuration fitted in the width
- Levelling feet

## Detailed drawings:

Available on the Internet.

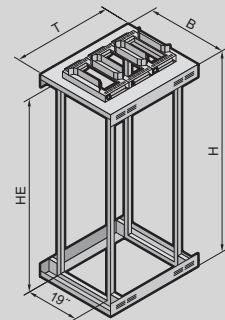

## TE 7000 open

U (HE)	Packs of	42	80	Page
Width (B) mm		600	800	
Height <sup>1)</sup> (H) mm		2000	2000	
Depth (T) mm		1000	1000	
Distance between levels (mm) as delivered		745	745	
<b>Model No. TE</b>	<b>1</b>	<b>7000.940</b>	<b>7000.944</b>	
<b>Accessories</b>				
Cable management panel 482.6 mm (19"), 1 U for horizontal cable routing, with 5 steel rings, zinc-plated, passivated, size 105 x 43 mm	1	7257.035	7257.035	539
Cable management panel 482.6 mm (19"), 2 U for horizontal cable routing, with 5 steel rings, zinc-plated, passivated, size 125 x 85 mm	1	7257.100	7257.100	539
Shunting rings to accommodate large quantities of cables, for mounting on the side of the mounting frame, dimension 330 x 90 mm	4	7220.600	7220.600	534
Cable management duct 482.6 mm (19"), 2 U for horizontal cable routing, with removable front panel	1	7158.100	7158.100	541
Component shelf 482.6 mm (19"), 1/2 U static installation, depth-variable in the range from 600 – 900 mm	1	7063.720	7063.720	485
Slide rail 482.6 mm (19"), load capacity 100 kg, for 740 mm distance between 482.6 mm (19") levels (internal)	2	7063.740	7063.740	560
Slide rail 482.6 mm (19"), depth-variable within the range from 590 – 930 mm, load capacity 80 kg, static	2	7063.883	7063.883	559
C rail, variable within the range 450 – 800 mm	1	7016.140	7016.140	532
T-head rail, variable within the range 450 – 800 mm	1	7016.150	7016.150	532
Cable route for vertical cable management, for mounting at the side rear of the 482.6 mm (19") mounting frame, W = 100 mm, H = 1700 mm	1 set	7000.685	7000.685	536
Cable duct, 42 U	1	7827.320	7827.320	538
Cable manager, basic kit, for system-compatible cable deflection	8	7064.100	7064.100	533
Cable routing bars for 482.6 mm (19") system punchings	4	7111.224	7111.224	537

<sup>1)</sup> Plus 100 mm roof-mounting/cable-routing trays.





482.6 mm (19") installation system Page 558 Monitoring Page 577 Power System Module Page 201

**Material:**

- Profile frame, base/plinth: Sheet steel
- Feet: Die-cast zinc

**Colour:**

- Profile frame, base/plinth: RAL 7035
- Trim panel, feet: RAL 5018

**Load capacity:**

Max. 150 kg, static/level

**Supply includes:**

- Torsionally stiff profile frame with 482.6 mm (19") punchings
- Stable base/plinth with integral feet, with the option for base anchoring
- Assembly parts

**Note:**

Order second mounting level separately.

**Detailed drawings:**

Available on the Internet.

Photo shows a configuration example with equipment not included in the scope of supply.

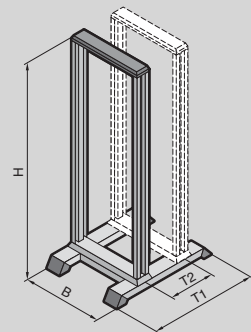

## Data Rack

U	Packs of	31	36	40	45	Page
Width (B) mm		550	550	550	550	
Height (H) mm		1499.5	1721.8	1899.5	2121.8	
Depth (T1) mm		750	750	750	750	
Distance from the second mounting level (T2) mm <sup>1)</sup>		min. 150 – max. 350				
<b>Model No. DK</b>	1	<b>7391.000</b>	<b>7396.000</b>	<b>7400.000</b>	<b>7445.000</b>	
<b>Accessories</b>						
Second mounting level <sup>1)</sup>	1	7296.000	7297.000	7298.000	7299.000	558
Baying connector	3	7494.000	7494.000	7494.000	7494.000	558
Levelling feet	4	7493.000	7493.000	7493.000	7493.000	373
Cable duct, 42 U	1	7827.320	7827.320	7827.320	7827.320	538
C rails, 482.6 mm (19")	6	7016.100	7016.100	7016.100	7016.100	542
Cable clamp rails, 482.6 mm (19")	6	7016.110	7016.110	7016.110	7016.110	542
Cable clamp strap D = 250 mm	6	7016.120	7016.120	7016.120	7016.120	542
Twin castors	4	7495.000	7495.000	7495.000	7495.000	374
Depth stays	2	7401.000	7401.000	7401.000	7401.000	558
Component shelf 2 U for one pair of mounting angles D = 250 mm	1	7119.250	7119.250	7119.250	7119.250	487
Component shelf 2 U for one pair of mounting angles D = 400 mm	1	7119.400	7119.400	7119.400	7119.400	487
Component shelf 2 U for one pair of mounting angles D = 300 mm <sup>3)</sup>	1	7148.035	7148.035	7148.035	7148.035	485
Drawer 2 U for one pair of mounting angles	1	7281.035	7281.035	7281.035	7281.035	614
Component shelf D = 300 mm <sup>2) 3)</sup>	1	7143.035	7143.035	7143.035	7143.035	482
Component shelf D = 400 mm <sup>2) 3)</sup>	1	7144.035	7144.035	7144.035	7144.035	482
Component shelf D = 500 mm <sup>2) 3)</sup>	1	7145.035	7145.035	7145.035	7145.035	482
Slide rails D max. < 190 mm	10	1962.200	1962.200	1962.200	1962.200	548
Slide rails D max. > 190 mm	10	1963.200	1963.200	1963.200	1963.200	548
Slide rails for two pairs of mounting angles <sup>1) 2) 4)</sup>	2	7402.000	7402.000	7402.000	7402.000	558

<sup>1)</sup> Second mounting level may be positioned on a 50 mm pitch pattern.

<sup>2)</sup> A second pair of mounting angles is required for assembly.

<sup>3)</sup> Stationary installation or full withdrawal, telescopic slides, see page 489.

<sup>4)</sup> 350 mm distance between levels (T2), can be combined with component shelf ≥ D = 500 mm.



# Server enclosures

---

## Server enclosures TS 8

Server enclosures TS 8 .....	92
Colocation .....	93
For High Performance Cooling systems HPC .....	94

## Server enclosures TE 7000

Server enclosures TE 7000 .....	95
---------------------------------	----



# Server enclosures TS 8



**System accessories** Page 355 **Power System Module** Page 201 **Monitoring** Page 577 **Climate control** Page 207

**Material:**  
Sheet steel

**Colour:**  
RAL 7035

**Detailed drawing:**  
Available on the Internet.

**Surface finish:**

- Enclosure frame: Dipcoat-primed
- Enclosure panels: Dipcoat-primed, powder-coated
- Mounting angles, mounting frame and punched sections with mounting flanges: Zinc-plated

**Supply includes:**  
Product-specific supply scope, see table.

Photo shows a configuration example with equipment not included in the scope of supply.

<b>U</b>	Packs of	24	42	42	47	42	42	Page
<b>Width</b> mm		600	600	600	600	800	800	
<b>Height</b> mm		1200	2000	2000	2200	2000	2000	
<b>Depth</b> mm		1000	1000	1200	1000	1000	1200	
Distance between levels, pre-configured mm		740	740	740	740	740	740	
482.6 mm (19") level, flat mounting angles on punched sections with mounting flanges, front and rear, depth-variable	2	■	■	■	■	–	–	
482.6 mm (19") mounting frames, front and rear, depth-variable	2	–	–	–	–	■	■	
<b>Model No. DK</b>	1	<b>7831.433<sup>2)</sup></b>	<b>7831.438</b>	<b>7831.481</b>	<b>7831.442</b>	<b>7831.446</b>	<b>7831.485</b>	
<b>Supply includes</b>								
Enclosure frame	1	■	■	■	■	■	■	
Sheet steel doors, vented <sup>1)</sup> , front and rear	2	■	■	■	■	■	■	
Roof plate for cable entry, two-piece	1	■	■	■	■	■	■	
Levelling feet	4	■	■	■	■	■	■	
Open base, without base frame	1	■	■	■	■	■	■	
Comfort handle for semi-cylinder with security lock 3524 E	2	■	■	■	■	■	■	
Earthing of all enclosure panels pre-configured	1 set	■	■	■	■	■	■	
<b>Accessories</b>								
Side panels, lockable	2	7824.120	7824.200	–	7824.220	7824.200	–	387
Side panel, plug-type, divided	1	–	–	7824.310	–	–	7824.310	388
Base mounting bracket	4	8800.210	8800.210	8800.210	8800.210	8800.210	8800.210	376
Depth-variable slide rail, 1 U	2	7063.883	7063.883	7063.883	7063.883	7063.883	7063.883	559
Stabiliser, pull-out	1	7825.250	7825.250	7825.260 <sup>2)</sup>	7825.250	7825.250	7825.260 <sup>2)</sup>	372

■ Included with the supply. <sup>1)</sup> Vented surface area > 78% perforated. <sup>2)</sup> Extended delivery times.



**System accessories** Page 355 **Power System Module** Page 201 **Monitoring** Page 577 **Climate control** Page 207

### Design features

- Robust frame structure
- Front and rear door fully vented; vented surface area > 78% perforated
- 2-point locking
- Door hinge may be swapped to opposite side without machining
- Cable entry via the base/plinth and roof (optional)
- Bayable at all levels
- Static load capacity of up to 1000 kg

### Material:

Sheet steel

### Surface finish:

- Enclosure frame: Dipcoat-primed
- Enclosure panels: Dipcoat-primed, powder-coated
- Mounting angles, mounting frame and punched sections with mounting flanges: Zinc-plated

### Colour:

RAL 7035

### Supply includes:

Product-specific supply scope, see table.

### Detailed drawing:

Available on the Internet.

Photo shows a configuration example with equipment not included in the scope of supply.

## Colocation

Number of front and rear doors	Packs of	2/2	4/4	Page
<b>U</b>		2 x 21	4 x 10	
<b>Width</b> mm		600	600	
<b>Height</b> mm		2200	2200	
<b>Depth</b> mm		1000	1000	
Distance between levels, pre-configured mm		740	740	
<b>Model No. DK</b>	1	<b>7831.453<sup>1)</sup></b>	<b>7831.463<sup>1)</sup></b>	
<b>Supply includes</b>				
Sheet steel doors, vented, front and rear with 180° hinges		■	■	
Roof plate, solid	1	■	■	
Levelling feet	4	■	■	
482.6 mm (19") levels, flat mounting angles on punched sections with mounting flanges, front and rear, depth-variable		■	■	
Earthing of all enclosure panels pre-configured		■	■	
Individual compartments, shielded/separate cable routing per compartment		■	■	
Comfort handle for semi-cylinder with security lock 3524 E		■	■	
<b>Accessories</b>				
Side panels, lockable	2	7824.220	7824.220	387
Base mounting bracket	4	8800.210	8800.210	376
Depth-variable slide rail, 1 U	2	7063.883	7063.883	559
Semi-cylinder for individual lock	2	9785.042	9785.042	416
Quick-fit baying clamps	6	8800.500	8800.500	395
Stabiliser, pull-out	1	7825.250	7825.250	372

■ Included with the supply. <sup>1)</sup> Extended delivery times.

# Server enclosures TS 8



**System accessories** Page 355 **Baying system** Page 394 **Monitoring** Page 577

## Load capacity:

Max. static load capacity of the interior installation 1000 kg

## Material:

- Sheet steel
- Glazed door: Single-pane safety glass, 4 mm

## Surface finish:

- Enclosure frame: Dipcoat-primed
- Enclosure panels: Additionally powder-coated
- Gland plates and 482.6 mm (19") mounting frame: Zinc-plated

## Colour:

RAL 7035

## Protection category:

IP 54 to IEC 60 529, in conjunction with solid roof plate (bayed option) and additional screw-fastened side panels with stand-alone siting.

## Supply includes:

Product-specific supply scope, see table.

Photo shows a configuration example with equipment not included in the scope of supply.

## For High Performance Cooling systems HPC

U	Packs of	42	42	42	42	42	42	Page
<b>Width</b> mm		600	600	600	800	800	800	
<b>Height</b> mm		2000	2000	2000	2000	2000	2000	
<b>Depth</b> mm		1000	1200	1200	1000	1200	1200	
Distance between levels, pre-configured mm		740	740	740	740	740	740	
Including side panels		-	-	■	-	-	■	
<b>Model No. DK</b>	1	<b>7831.810<sup>1)</sup></b>	<b>7831.812<sup>1)</sup></b>	<b>7831.813<sup>1)</sup></b>	<b>7831.800<sup>1)</sup></b>	<b>7831.802<sup>1)</sup></b>	<b>7831.803<sup>1)</sup></b>	
<b>Supply includes</b>								
Glazed aluminium door at the front (180°)	1	■	■	■	■	■	■	
Sheet steel door at the rear (130°)	1	■	■	■	■	■	■	
Comfort handle front and rear for semi-cylinder, security lock 3524 E	2	■	■	■	■	■	■	
Roof plate for cable entry, two-piece	1	■	■	■	■	■	■	
Levelling feet	4	■	■	■	■	■	■	
Base frame with multi-piece gland plate	1	■	■	■	■	■	■	
482.6 mm (19") mounting frames, front and rear, depth-variable	2	■	■	■	■	■	■	
Earthing of all enclosure panels pre-configured	1 set	■	■	■	■	■	■	
<b>Accessories</b>								
Side panel, screw-fastened, IP 55	2	8100.235	-	■	8100.235	-	■	385
Depth-variable slide rail, 1 U, length 590 – 930 mm, 80 kg, static	2	7063.883	7063.883	7063.883	7063.883	7063.883	7063.883	559
482.6 mm (19") heavy-duty component shelf, 700 mm deep, 100 kg static load capacity	1	7063.897	7063.897	7063.897	7063.897	7063.897	7063.897	484
Installation kit for heavy-duty component shelf, depth-variable	1 set	7063.890	7063.890	7063.890	7063.890	7063.890	7063.890	488
Flex-Block		see page 358						
Liquid Cooling Package		see page 279						

■ Included with the supply. <sup>1)</sup> Extended delivery times.

# Server enclosures TE 7000



System accessories Page 355 Power System Module Page 201 Monitoring Page 577 Climate control Page 207

#### Benefits:

- No frame structure
- Optimum accessibility
- Readily dismantled and therefore easily installed

#### Material:

Sheet steel

#### Surface finish:

- Mounting frame: Dipcoat-primed
- Enclosure panels: Powder-coated

#### Colour:

See table.

#### Supply includes:

Product-specific supply scope, see table.

#### Detailed drawing:

Available on the Internet.

Photo shows a configuration example with equipment not included in the scope of supply.

U	Packs of	24	42	42	42	42	Page
Width mm		600	600	600	800	800	
Height mm		1200	2000	2000	2000	2000	
Depth mm		1000	1000	1000	1000	1000	
Distance between levels, pre-configured mm		745	745	745	745	745	
Colour		RAL 7035	RAL 7035	RAL 9005	RAL 7035	RAL 9005	
Model No. TE	1	<b>7000.875</b>	<b>7000.882</b>	<b>7000.885</b>	<b>7000.892</b>	<b>7000.895</b>	

#### Supply includes

Self-supporting 482.6 mm (19") mounting frame, front and rear, depth-variable	2	■	■	■	■	■	
Sheet steel door vented <sup>2)</sup> , front with moulded handle, 130° hinge, security lock 3524 E	1	■	■	■	■	■	
Sheet steel door vented <sup>2)</sup> , rear with moulded handle, 130° hinge, security lock 3524 E	1	■	■	■	■	■	
Levelling feet	4	■	■	■	■	■	
Roof plate including brush strip for cable entry and optional fitting with an active fan unit	1	■	■	■	■	■	
Base frame with maximum cut-out for optional fitting with module plates, solid, passively vented or for cable entry	1	■	■	■	■	■	

#### Accessories

Side panels, lockable, including security lock 3524 E	2	■	7000.653	7000.663	7000.653	7000.663	388
Baying kit	1 set	7000.640	■	■	■	■	400
Ergoform-S handle for semi-cylinder, to exchange for the existing lock	1	2435.000	2435.000	2452.000 <sup>1)</sup>	2435.000	2452.000 <sup>1)</sup>	419
Fan unit, with 2 fans and thermostat, pre-wired ready for connection	1	7000.670	7000.670	–	7000.670	–	224
Transport castors, including assembly parts	4	7000.672	7000.672	7000.672	7000.672	7000.672	375
C rail, for cable clamping in the enclosure width via cable clamps, on the 482.6 mm (19") mounting frame at the rear	4	7828.060	7828.060	7828.060	7828.060	7828.060	465
Slide rail, 482.6 mm (19") for 740 mm distance between levels	2	7063.740	7063.740	7063.740	7063.740	7063.740	560
Cable clamp rail, depth-variable 500 – 895 mm, for cable attachment in the enclosure depth via cable ties	4	7858.162	7858.162	7858.162	7858.162	7858.162	532
Cable clamp rail, for cable attachment in the enclosure width via cable ties, on the 482.6 mm (19") mounting frame at the rear	4	7828.062	7828.062	7828.062	7828.062	7828.062	532
Earthing kit for TE	1 set	7000.675	7000.675	7000.675	7000.675	7000.675	503
Socket strip for TE, 8-way for earthing-pin plugs	1	7000.630	7000.630	7000.630	7000.630	7000.630	506

■ Included with the supply. <sup>1)</sup> Matt nickel-plated <sup>2)</sup> Vented surface area > 67% perforated.





# Console systems/ PC enclosure systems/ Industrial Workstations

---

## TopConsole system TP

Overview of mounting components .....	99
Combination options .....	100
600 mm wide .....	101
800 mm wide .....	102
1200 mm wide .....	103
1600 mm wide .....	104
Accessories .....	105

## One-piece consoles TP

One-piece consoles TP .....	106
-----------------------------	-----

## Universal consoles TP

Universal consoles TP .....	107
-----------------------------	-----

## PC enclosure systems

PC enclosure systems TS 8 .....	108
Enclosure for tower PC .....	109

## Industrial Workstations

Combination options .....	110
IW enclosures and worktops .....	111





# TopConsole system TP

## Overview of mounting components

- 1 Punched section with mounting flange, 17 x 73 mm
- 2 Support strips
- 3 Partial mounting plates
- 4 Rail for interior installation
- 5 Gland plates
- 6 Cable entry grommets
- 7 Base/plinth
- 8 Assembly bolts for base/plinth

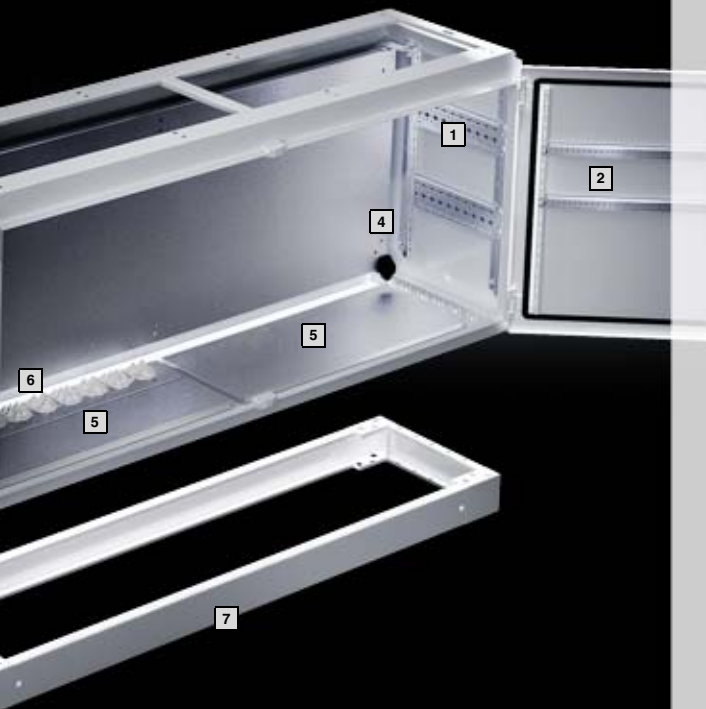
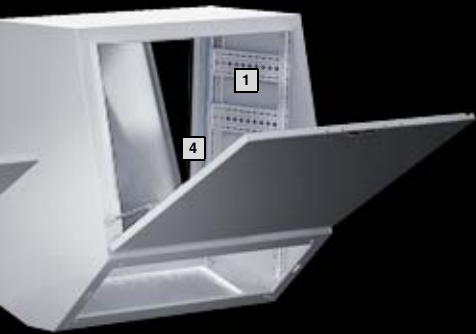

# TopConsole system TP



System accessories Page 355 Monitors, keyboards From page 606 Climate control Page 207

## Material:

- Enclosure: Sheet steel 1.5 mm
- Door and console cover: Sheet steel, 2.0 mm, all-round foamed-in PU seal
- Mounting plate: Sheet steel 2.5 mm

## Surface finish:

- Dipcoat-primed, powder-coated on the outside, textured paint
- Mounting plate zinc-coated on bottom part

## Colour:

RAL 7035

## Protection category:

IP 55 to IEC 60 529, complies with NEMA 12 (provided suitable gland plates are selected)

## Supply includes:

### Console

- Enclosure
- Cover hinged at bottom, including cover retainer
- Open base for individual cable entry

### Console, deep

- Enclosure
- Front cover hinged at bottom, including cover retainer
- Rear door, hinged at bottom
- Open base for individual cable entry

### Desk section

- Enclosure
- Cover hinged, 2 stays with automatic locking and unlocking
- Opening for running cables into the enclosure base

## Pedestal

- Enclosure open at top
- Door or double door with locking rod (with depth 400 mm at the front, with depth 500 mm at the front and rear)
- Depth-adjustable mounting plate (with depth 500 mm)
- Open base for individual cable entry

## ! Also required:

Gland plates, see page 378.

## Approvals:

- CE
- UL
- cUL

## Detailed drawings:

Available on the Internet.

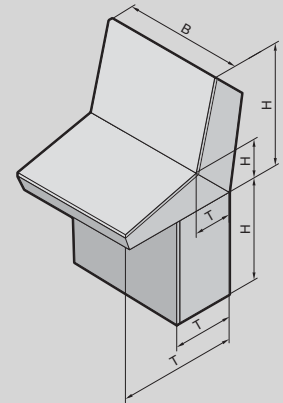
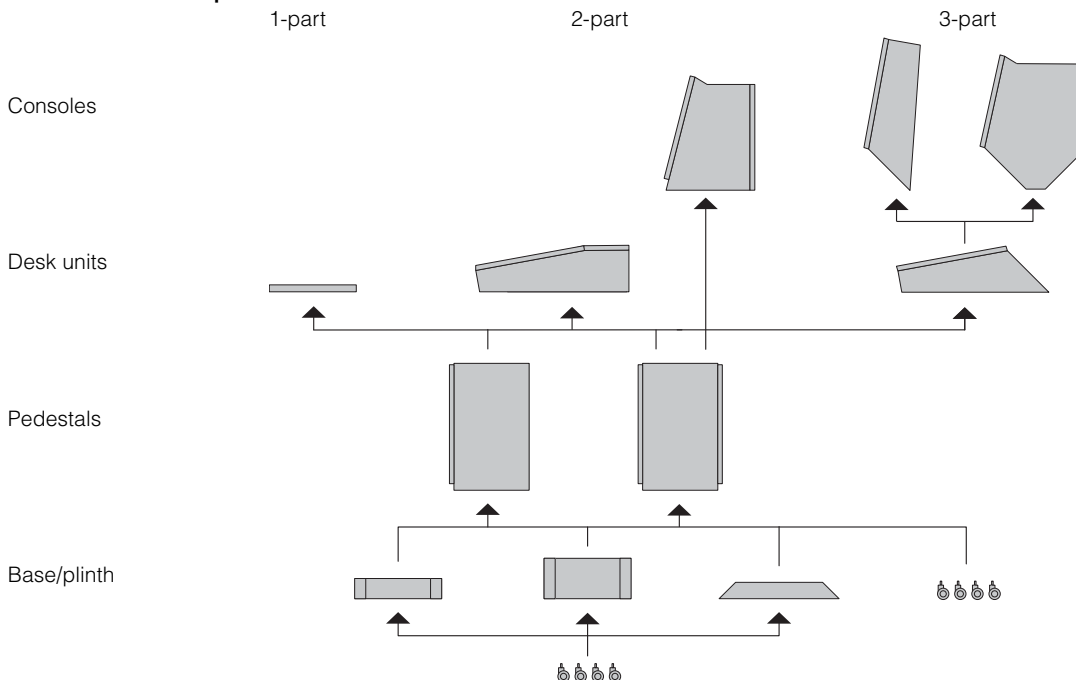

Photo shows a configuration example with equipment not included in the scope of supply.

## Combination options



# TopConsole system TP

600 mm wide

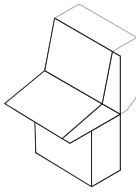
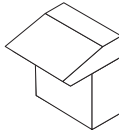
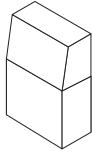
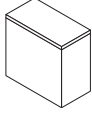
									
Configuration	3-part		2-part		2-part		1-part		
Depth of pedestal in mm	400	500	400	500	400	500	400	500	

Consoles 700 mm high										
Height (H) mm	Packs of	700		-		-		-		Page
Depth (T) mm		240		-		-		-		
Model No. TP	1	<b>6720.500</b>		-		-		-		

Consoles 540/730 mm high with enlarged installation depth											
Height (H) mm	Packs of	-	730	-		-		540	-		Page
Depth (T) mm		-	520	-		-		520	-		
Model No. TP	1	-	<b>6720.200</b>	-		-		<b>6720.100</b>	-		

Accessories											
Partial mounting plate	Width 200 mm	1	6730.310	-		-		6730.310 <sup>1)</sup>	-		450
	Width 500 mm	1	6730.330	-		-		6730.330 <sup>1)</sup>	-		450
Rail for interior installation	For width	4	5001.050	-		-		5001.050	-		459
	For height	4	5001.051	-		-		5001.050	-		459

Desk units										
Height (H) mm	Packs of	235		235		-		-		Page
Depth (T) mm		700		700		-		-		
Model No. TP	1	<b>6714.500</b>		<b>6710.500</b>		-		-		

Accessories										
Rail for interior installation	For width	4	5001.050	5001.050		-		-		459
Strengtheners		1	-	6730.400		-		-		105
Trim panel for pedestal		1	-	-		-		5001.130	6370.100	105

Pedestals											
Height (H) mm	Packs of	675	675	675	675	-		675	675	675	Page
Depth (T) mm		400	500	400	500	-		500	400	500	
Model No. TP	1	<b>6700.500</b>	<b>6704.500</b>	<b>6700.500</b>	<b>6704.500</b>	-		<b>6704.500</b>	<b>6700.500</b>	<b>6704.500</b>	

Accessories											
Base/plinth components front and rear	Height 100 mm	1 set	8601.600	8601.600	8601.600	8601.600	-	8601.600	8601.600	8601.600	361
	Height 200 mm	1 set	8602.600	8602.600	8602.600	8602.600	-	8602.600	8602.600	8602.600	361
Base/plinth trim panels, side	Height 100 mm	1 set	8601.040	8601.050	8601.040	8601.050	-	8601.050	8601.040	8601.050	362
	Height 200 mm	1 set	8602.040	8602.050	8602.040	8602.050	-	8602.050	8602.040	8602.050	362
Cross member, adjustable		2	8601.450	8601.450	8601.450	8601.450	-	8601.450	8601.450	8601.450	370
Gland plates	1-part	1	5001.222	-	5001.222	-	-	-	5001.222	-	379
	2-part	1	5001.214 +	5001.214 +	5001.214 +	5001.214 +	-	5001.214 +	5001.214 +	5001.214 +	379
		1	5001.218	5001.222	5001.218	5001.222	-	5001.222	5001.218	5001.222	379
Individual For more gland plate variants, see page 381											
Rail for interior installation	For height	4	5001.050	5001.050	5001.050	5001.050	-	5001.050	5001.050	5001.050	459
Punched section with mounting flange, 17 x 73 mm	In the depth	4	8612.140	8612.150	8612.140	8612.150	-	8612.150	8612.140	8612.150	459
Punched rail 18 x 38 mm	In the depth	4	8612.240	8612.250	8612.240	8612.250	-	8612.250	8612.240	8612.250	462
Support strips	In the depth	20	4694.000	4695.000	4694.000	4695.000	-	4695.000	4694.000	4695.000	462
Punched section with mounting flange, 17 x 73 mm	For door	4	8612.050	8612.050	8612.050	8612.050	-	8612.050	8612.050	8612.050	459
Support strips	For door	20	4596.000	4596.000	4596.000	4596.000	-	4596.000	4596.000	4596.000	462
Cable clamp rail		1	5001.080	5001.080	5001.080	5001.080	-	5001.080	5001.080	5001.080	527
Wiring plan pocket		1	4116.500	4116.500	4116.500	4116.500	-	4116.500	4116.500	4116.500	429
Alternative lock systems	see page 413										

<sup>1)</sup> Configuration examples and further details of the accessories required may be found on the Internet.

# TopConsole system TP

800 mm wide

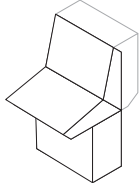
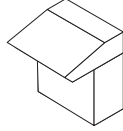
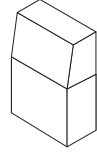
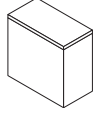
									
Configuration	3-part		2-part		2-part		1-part		
Depth of pedestal in mm	400	500	400	500	400	500	400	500	

Consoles 700 mm high									
Height (H) mm	Packs of	700	-		-		-		Page
Depth (T) mm		240	-		-		-		
Model No. TP	1	<b>6721.500</b>	-		-		-		

Consoles 540/730 mm high with enlarged installation depth									
Height (H) mm	Packs of	-	730	-		-		540	Page
Depth (T) mm		-	520	-		-		520	
Model No. TP	1	-	<b>6721.200</b>	-		-		<b>6721.100</b>	

Accessories										
Partial mounting plate	Width 200 mm	1	6730.310	-		-		6730.310 <sup>1)</sup>	-	450
	Width 500 mm	1	6730.330	-		-		6730.330 <sup>1)</sup>	-	450
	Width 700 mm	1	6730.340	-		-		6730.340 <sup>1)</sup>	-	450
Rail for interior installation	For width	4	5001.051	-		-		5001.051	-	459
	For height	4	5001.051	-		-		5001.050	-	459

Desk units									
Height (H) mm	Packs of	235	235		-		-		Page
Depth (T) mm		700	700		-		-		
Model No. TP	1	<b>6715.500</b>	<b>6711.500</b>		-		-		

Accessories										
Rail for interior installation	For width	4	5001.051	5001.051		-		-		459
Strengtheners		1	-	6730.410		-		-		105
Trim panel for pedestal		1	-	-		-		5001.140	6730.110	105

Pedestals											
Height (H) mm	Packs of	675	675	675	675	-		675	675	675	Page
Depth (T) mm		400	500	400	500	-		500	400	500	
Model No. TP	1	<b>6701.500</b>	<b>6705.500</b>	<b>6701.500</b>	<b>6705.500</b>	-		<b>6705.500</b>	<b>6701.500</b>	<b>6705.500</b>	

Accessories											
Base/plinth components front and rear	Height 100 mm	1 set	8601.800	8601.800	8601.800	8601.800	-	8601.800	8601.800	8601.800	361
	Height 200 mm	1 set	8602.800	8602.800	8602.800	8602.800	-	8602.800	8602.800	8602.800	361
Base/plinth trim panels, side	Height 100 mm	1 set	8601.040	8601.050	8601.040	8601.050	-	8601.050	8601.040	8601.050	362
	Height 200 mm	1 set	8602.040	8602.050	8602.040	8602.050	-	8602.050	8602.040	8602.050	362
Cross member, adjustable		2	8601.450	8601.450	8601.450	8601.450	-	8601.450	8601.450	8601.450	370
	1-part	1	5001.223	-	5001.223	-	-	-	5001.223	-	379
Gland plates	2-part	1	5001.215	5001.215	5001.215	5001.215	-	5001.215	5001.215	5001.215	379
		+	+	+	+	-	+	+	+		
	1	5001.219	5001.223	5001.219	5001.223	-	5001.223	5001.219	5001.223	379	
	Individual	For more gland plate variants, see page 381									
Rail for interior installation	For height	4	5001.050	5001.050	5001.050	5001.050	-	5001.050	5001.050	5001.050	459
Punched section with mounting flange, 17 x 73 mm	In the depth	4	8612.140	8612.150	8612.140	8612.150	-	8612.150	8612.140	8612.150	459
Punched rail 18 x 38 mm	In the depth	4	8612.240	8612.250	8612.240	8612.250	-	8612.250	8612.240	8612.250	462
Support strips	In the depth	20	4694.000	4695.000	4694.000	4695.000	-	4695.000	4694.000	4695.000	462
Punched section with mounting flange, 17 x 73 mm	For door	4	8612.050	8612.050	8612.050	8612.050	-	8612.050	8612.050	8612.050	459
Support strips	For door	20	4598.000	4598.000	4598.000	4598.000	-	4598.000	4598.000	4598.000	462
Cable clamp rail		1	5001.081	5001.081	5001.081	5001.081	-	5001.081	5001.081	5001.081	527
Wiring plan pocket		1	4118.500	4118.500	4118.500	4118.500	-	4118.500	4118.500	4118.500	429
Alternative lock systems		see page 413									

<sup>1)</sup> Configuration examples and further details of the accessories required may be found on the Internet.

# TopConsole system TP

1200 mm wide

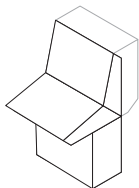
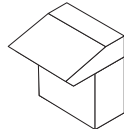
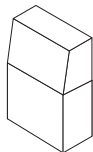
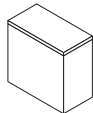
									
Configuration	3-part		2-part		2-part		1-part		
Depth of pedestal in mm	400	500	400	500	400	500	400	500	

Consoles 700 mm high									
Height (H) mm	Packs of	700	-		-		-		Page
Depth (T) mm		240	-		-		-		
Model No. TP	1	<b>6722.500</b>	-		-		-		

Consoles 540/730 mm high with enlarged installation depth									
Height (H) mm	Packs of	-	730	-		-		540	Page
Depth (T) mm		-	520	-		-		520	
Model No. TP	1	-	<b>6722.200<sup>3)</sup></b>	-		-		<b>6722.100<sup>3)</sup></b>	

Accessories										
Partial mounting plate	Width 200 mm	1	6730.310	-		-		6730.310 <sup>1)</sup>	-	450
	Width 500 mm	1	6730.330	-		-		6730.330 <sup>1)</sup>	-	450
	Width 700 mm	1	6730.340	-		-		6730.340 <sup>1)</sup>	-	450
Rail for interior installation	For width	4	5001.053	-		-		5001.053	-	459
	For height	4	5001.051	-		-		5001.050	-	459

Desk units									
Height (H) mm	Packs of	235	235		-		-		Page
Depth (T) mm		700	700		-		-		
Model No. TP	1	<b>6716.500</b>	<b>6712.500</b>		-		-		

Accessories										
Rail for interior installation	For width	4	5001.053	5001.053		-		-		459
Trim panel for pedestal		1	-	-		-		5001.160	6730.120	105

Pedestals											
Height (H) mm	Packs of	675	675	675	675	-		675	675	675	Page
Depth (T) mm		400	500	400	500	-		500	400	500	
Model No. TP	1	<b>6702.500</b>	<b>6706.500</b>	<b>6702.500</b>	<b>6706.500</b>	-		<b>6706.500</b>	<b>6702.500</b>	<b>6706.500</b>	

Accessories											
Base/plinth components front and rear	Height 100 mm	1 set	8601.200	8601.200	8601.200	8601.200	-	8601.200	8601.200	8601.200	361
	Height 200 mm	1 set	8602.200	8602.200	8602.200	8602.200	-	8602.200	8602.200	8602.200	361
Base/plinth trim panels, side	Height 100 mm	1 set	8601.040	8601.050	8601.040	8601.050	-	8601.050	8601.040	8601.050	362
	Height 200 mm	1 set	8602.040	8602.050	8602.040	8602.050	-	8602.050	8602.040	8602.050	362
Cross member, adjustable		2	8601.450	8601.450	8601.450	8601.450	-	8601.450	8601.450	8601.450	370
Gland plates <sup>2)</sup>	1-part	1	5001.225	-	5001.225	-	-	-	5001.225	-	379
	2-part	1	5001.217 +	5001.217 +	5001.217 +	5001.217 +	-	5001.217 +	5001.217 +	5001.217 +	379
		1	5001.221	5001.225	5001.221	5001.225	-	5001.225	5001.221	5001.225	379
Individual For more gland plate variants, see page 381											
Rail for interior installation	For height	4	5001.050	5001.050	5001.050	5001.050	-	5001.050	5001.050	5001.050	459
Punched section with mounting flange, 17 x 73 mm	In the depth	4	8612.140	8612.150	8612.140	8612.150	-	8612.150	8612.140	8612.150	459
Punched rail 18 x 38 mm	In the depth	4	8612.240	8612.250	8612.240	8612.250	-	8612.250	8612.240	8612.250	462
Support strips	In the depth	20	4694.000	4695.000	4694.000	4695.000	-	4695.000	4694.000	4695.000	462
Punched section with mounting flange, 17 x 73 mm	For door	4	8612.050	8612.050	8612.050	8612.050	-	8612.050	8612.050	8612.050	459
Support strips	For door	20	4596.000	4596.000	4596.000	4596.000	-	4596.000	4596.000	4596.000	462
Cable clamp rail		1	5001.083	5001.083	5001.083	5001.083	-	5001.083	5001.083	5001.083	527
Wiring plan pocket		1	4116.500	4116.500	4116.500	4116.500	-	4116.500	4116.500	4116.500	429
Alternative lock systems	see page 413										

<sup>1)</sup> Configuration examples and further details of the accessories required may be found on the Internet.

<sup>2)</sup> With the two-door pedestal, the base opening is divided in two, and two sets of gland plates are required!

<sup>3)</sup> Extended delivery times.

# TopConsole system TP

1600 mm wide

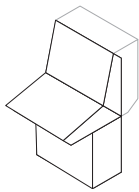
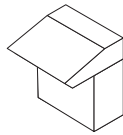
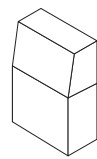
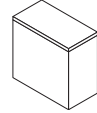
									
Configuration	3-part		2-part		2-part		1-part		
Depth of pedestal in mm	400	500	400	500	400	500	400	500	

Consoles 700 mm high										
Height (H) mm	Packs of	700	-		-		-		Page	
Depth (T) mm		240	-		-		-			
Model No. TP	1	<b>6723.500</b>	-		-		-			

Consoles 540/730 mm high with enlarged installation depth										
Height (H) mm	Packs of	-	730	-		-		540	Page	
Depth (T) mm		-	520	-		-		520		
Model No. TP	1	-	<b>6723.200</b>	-		-		<b>6723.100</b>	-	

Accessories										
Partial mounting plate	Width 200 mm	1	6730.310	-		-		6730.310 <sup>1)</sup>	450	
	Width 500 mm	1	6730.330	-		-		6730.330 <sup>1)</sup>	450	
	Width 700 mm	1	6730.340	-		-		6730.340 <sup>1)</sup>	450	
Rail for interior installation	For height	4	5001.051	-		-		5001.050	459	

Desk units										
Height (H) mm	Packs of	235	235		-		-		Page	
Depth (T) mm		700	700		-		-			
Model No. TP	1	<b>6717.500</b>	<b>6713.500</b>		-		-			

Accessories										
Rail for interior installation	For width	4	5001.054	5001.054		-		-		459
Trim panel for pedestal		1	-	-		-		6730.030	6730.130	105

Pedestals											
Height (H) mm	Packs of	675	675	675	675	-		675	675	675	Page
Depth (T) mm		400	500	400	500	-		500	400	500	
Model No. TP	1	<b>6703.500</b>	<b>6707.500</b>	<b>6703.500</b>	<b>6707.500</b>	-		<b>6706.500</b>	<b>6703.500</b>	<b>6707.500</b>	

Accessories											
Base/plinth components front and rear	Height 100 mm	1 set	8601.920	8601.920	8601.920	8601.920	-	8601.920	8601.920	8601.920	361
	Height 200 mm	1 set	8602.920	8602.920	8602.920	8602.920	-	8602.920	8602.920	8602.920	361
Base/plinth trim panels, side	Height 100 mm	1 set	8601.040	8601.050	8601.040	8601.050	-	8601.050	8601.040	8601.050	362
	Height 200 mm	1 set	8602.040	8602.050	8602.040	8602.050	-	8602.050	8602.040	8602.050	362
Cross member, adjustable		2	8601.450	8601.450	8601.450	8601.450	-	8601.450	8601.450	8601.450	370
Gland plates <sup>2)</sup>	1-part	1	5001.236	-	5001.236	-	-	-	5001.236	-	379
	2-part	1	5001.234	5001.234	5001.234	5001.234	-	5001.234	5001.234	5001.234	379
		1	5001.235	5001.236	5001.235	5001.236	-	5001.236	5001.235	5001.236	379
	Individual		For more gland plate variants, see page 381								
Rail for interior installation	For height	4	5001.050	5001.050	5001.050	5001.050	-	5001.050	5001.050	5001.050	459
Punched section with mounting flange, 17 x 73 mm	In the depth	4	8612.140	8612.150	8612.140	8612.150	-	8612.150	8612.140	8612.150	459
Punched rail 18 x 38 mm	In the depth	4	8612.240	8612.250	8612.240	8612.250	-	8612.250	8612.240	8612.250	462
Support strips	In the depth	20	4694.000	4695.000	4694.000	4695.000	-	4695.000	4694.000	4695.000	462
Support strips	For door	20	4598.000	4598.000	4598.000	4598.000	-	4598.000	4598.000	4598.000	462
Cable clamp rail	Width 800 mm	1	5001.081	5001.081	5001.081	5001.081	-	5001.081	5001.081	5001.081	527
Wiring plan pocket		1	4118.500	4118.500	4118.500	4118.500	-	4118.500	4118.500	4118.500	429
Alternative lock systems			see page 413								

<sup>1)</sup> Configuration examples and further details of the accessories required may be found on the Internet.

<sup>2)</sup> With the two-door pedestal, the base opening is divided in two, and two sets of gland plates are required!



# TopConsole system TP

## Accessories

### Trim panel

#### for pedestal

For covering the complete top opening when using the pedestal on its own.

#### Material:

Sheet steel

#### Surface finish:

Textured paint

#### Colour:

RAL 7035

#### Protection category:

IP 55 to IEC 60 529, complies with NEMA 12.

#### Supply includes:

Assembly parts.

For pedestal		Model No.
Width mm	Depth mm	
600	400	5001.130
800		5001.140
1200		5001.160
1600		6730.030
600	500	6730.100
800		6730.110
1200		6730.120
1600		6730.130



### Strengthenener

#### for desk unit, rear with hinged cover

- Suitable for mounting operating housings using
  - CP-L enclosure attachment, Ø 130 mm, CP 6525.510, see page 133
  - CP-XL enclosure attachment, round CP 6130.610, see page 141
  - Housing couplings CP-XL for desk mounting, CP 6528.410, see page 144
- Easily screw-fastened to the base of the desk unit.
- Connection hole pattern for CP support arm systems in the centre as standard; other positions can be accommodated by drilling extra holes.

Mounting cut-out required in the cover of the desk units, mounting cut-outs to match the various support arm systems.

#### Material:

Sheet steel

#### Supply includes:

Assembly parts.

For width mm	Packs of	Model No. TP
600	1	6730.400
800	1	6730.410

#### Mounting cut-outs

for the covers of the desk units

for external mounting of CP 6525.510

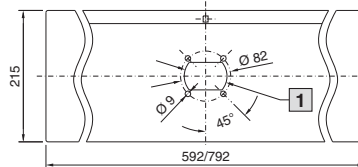

1 Max. Ø 70 mm

for external mounting of CP 6130.610

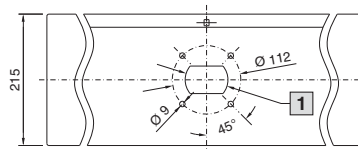

for external mounting of CP 6528.410

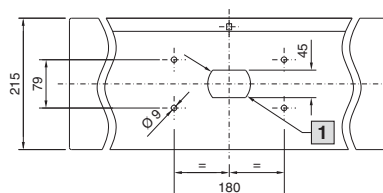

# One-piece consoles TP



System accessories Page 355 Monitors, keyboards From page 606 Climate control Page 207 One-piece consoles AP stainless steel Page 170

## Material:

- Enclosure: Sheet steel 1.5 mm
- Door and console cover: Sheet steel, 2.0 mm, all-round foamed-in PU seal
- Mounting plate: Sheet steel 3.0 mm
- Lock cover: Plastic, self-extinguishing

## Surface finish:

- Enclosure, cover and door: Dipcoat-primed, powder-coated on the outside, textured paint
- Mounting plate: Zinc-plated

## Colour:

RAL 7035

## Protection category:

IP 55 to IEC 60 529, complies with NEMA 12 (provided suitable gland plates are selected).

## Supply includes:

- Enclosure, solid back and sides
- Door or double door at front, with locking rod
- Mounting plate

- Cover hinged at rear, 2 stays with automatic locking and unlocking
- Open base for individual cable entry

## ! Also required:

Gland plates, see page 378 – 380.

## Detailed drawings:

Available on the Internet.

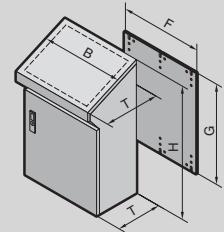

Width (B) mm	Packs of	600	800	1000	1200	Page
Height (H) mm		960	960	960	960	
Depth (T) mm	Bottom	400	400	400	400	
	Top	520	520	520	520	
Mounting plate width (F) mm		530	730	930	1130	
Mounting plate height (G) mm		900	900	900	900	
<b>Model No. TP</b>	1	<b>6746.500</b>	<b>6748.500</b>	<b>6740.500</b>	<b>6742.500</b>	
Door(s)		1	1	2	2	

Base/plinth							
Components front and rear	Height 100 mm	1 set	8601.600	8601.800	8601.000	8601.200	361
	Height 200 mm	1 set	8602.600	8602.800	8602.000	8602.200	361
Trim panels, sides	Height 100 mm	1 set	8601.040	8601.040	8601.040	8601.040	362
	Height 200 mm	1 set	8602.040	8602.040	8602.040	8602.040	362
Cross member, adjustable		2	8601.450	8601.450	8601.450	8601.450	370

Accessories							
Gland plates <sup>1)</sup>	1-part	1	5001.222	5001.223	5001.224	5001.225	379
	2-part	1	5001.214	5001.215	5001.216	5001.217	379
		+	+	+	+	+	
		1	5001.218	5001.219	5001.220	5001.221	
Individual		For more gland plate variants, see page 381					
Rail for interior installation	For enclosures	4	5001.051	5001.051	5001.051	5001.051	157
	For cover	4	5001.050	5001.051	5001.052	5001.053	157
Punched section with mounting flange, 17 x 73 mm	For enclosures	4	8612.140	8612.140	8612.140	8612.140	459
	For cover	4	8612.040	8612.040	8612.040	8612.040	459
	For door	4	8612.050	–	8612.040	8612.050	459
Punched rail 18 x 38 mm	For enclosures	4	8612.240	8612.240	8612.240	8612.240	462
Cable clamp rail		1	5001.080	5001.081	5001.082	5001.083	527
Wiring plan pocket		1	4116.500	4118.500	4115.500	4116.500	429
Alternative lock systems	see page 413						

<sup>1)</sup> With the two-door variant, the base opening is divided in two, and two sets of gland plates are required!



**System accessories** Page 355 **Monitors, keyboards** From page 606 **Climate control** Page 207

**Material:**

- Enclosure, gland plates: Sheet steel 1.5 mm
- Doors: Sheet steel 2.0 mm
- Mounting plate: Sheet steel 3.0 mm

**Surface finish:**

- Enclosure and doors: Dipcoat-primed, powder-coated on the outside, textured paint
- Mounting plate and gland plates: Zinc-plated

**Colour:**

RAL 7035

**Protection category:**

- IP 55 to IEC 60 529, complies with NEMA 12.

- With a short bottom door (TP 2694.500), the drawer or desk section (see below) should be fitted in order to preserve the protection category.

**Supply includes:**

- Enclosure with doors
- Mounting plate
- Gland plates

**Note:**

Top door with studs left and right for installing vertical perforated mounting strips SZ 2310.038 and horizontal support strips SZ 2325.000 to be mounted on top (see page 426/427).

**Approvals:**

- UL
- CSA
- TÜV
- Germanischer Lloyd
- Russian Maritime Register of Shipping
- Lloyds Register of Shipping
- VDE

**Detailed drawing:**

Available on the Internet.

Photo shows a configuration example with equipment not included in the scope of supply.

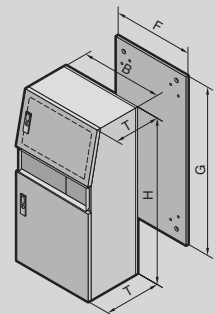

	Packs of		with short front door	with tall front door	Page
<b>Width (B) mm</b>			600	600	
<b>Height (H) mm</b>			1300	1300	
<b>Depth (T) mm</b>	Bottom		500	500	
	Top		417.5	417.5	
Mounting plate width (F) mm			499	499	
Mounting plate height (G) mm			1196	1196	
<b>Model No. TP</b>	1		<b>2694.500</b>	<b>2695.500</b>	
Weight (kg)			77.0	80.0	
<b>Also required</b>					
Desk section			<b>2696.500</b>	<b>2696.500</b>	-
Drawer for keyboard			-	-	<b>4757.500<sup>1)</sup></b>
<b>Accessories</b>					
Base/plinth	Height 100 mm	1	2807.200	2807.200	369
	Height 200 mm	1	2808.200	2808.200	369
Cross member, adjustable		2	8601.450	8601.450	370
Perforated mounting strip		1	2310.038	2310.038	427
Support strips		1	2325.000	2325.000	426
Cable clamp rail		1	4191.000	4191.000	527
Alternative lock systems			see page 413		

<sup>1)</sup> Only suitable for installation without a mounting plate.

# PC enclosure systems



**System accessories** Page 355 **Monitors, keyboards** From page 606 **Climate control** Page 207 **PC case system, stainless steel** Page 171

### Material:

- Enclosure, door, mounting compartment, supports: Sheet steel
- Handles, decorative trim panels: Plastic
- Door trim panels: Aluminium

### Protection category:

IP 55 to IEC 60 529, complies with NEMA 12.

### Supply includes:

Enclosure, door, rear door and enclosure-specific supply scope (see table)

### Approvals:

- UL
- CSA
- TÜV
- Germanischer Lloyd
- Russian Maritime Register of Shipping
- Lloyds Register of Shipping
- VDE

### Detailed drawings/

**Technical information:**  
Available on the Internet.

Photo shows a configuration example with equipment not included in the scope of supply.

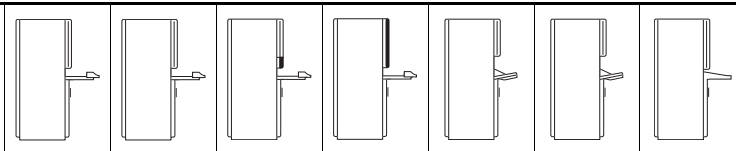

### Enclosure-specific supply scope

	Packs of	■	■	■	■	–	–	–	Page
Keyboard drawer		■	■	■	■	–	–	–	
Folding keyboard		–	–	–	–	■	■	–	
Desk section		–	–	–	–	–	–	■	
Glazed door, top		■	■	■	–	■	■	■	
Mounting compartment, small		–	–	■	–	–	–	–	
Mounting compartment, large		–	–	–	■	–	–	–	
Component shelf		■	■	■	–	■	■	■	
<b>Width mm</b>		600	600	600	600	600	600	600	
<b>Height mm</b>		1600	1600	1600	1600	1600	1600	1600	
<b>Depth mm</b>		636	836	636	636	636	836	636	
<b>Model No. PC</b>	1	<b>8366.000</b>	<b>8368.000</b>	<b>8366.300</b>	<b>8366.400</b>	<b>8366.100</b>	<b>8368.100</b>	<b>8366.200</b>	
Max. keyboard dimensions mm	Width	480	480	480	480	475	475	540	
	Height	70	70	70	70	60	50	60	40
	Depth	260	260	260	260	200	250	200	175
Weight (kg)		118	133	118	117	118	124	108	

### Accessories

Base/plinth, stationary	1	8800.920	on request	8800.920	8800.920	8800.920	on request	8800.920	366	
Base/plinth components front and rear	Height 100 mm	1 set	8601.600	8601.600	8601.600	8601.600	8601.600	8601.600	361	
	Height 200 mm	1 set	8602.600	8602.600	8602.600	8602.600	8602.600	8602.600	361	
Base/plinth trim, front	Height 200 mm	1	8360.920	8360.920	8360.920	8360.920	8360.920	8360.920	366	
	Height 100 mm	1 set	8601.060	8601.080	8601.060	8601.060	8601.060	8601.080	362	
Base/plinth trim, side	Height 200 mm	1 set	8602.060	8602.080	8602.060	8602.060	8602.060	8602.080	362	
	Height 70 mm	2	8601.680	8601.680	8601.680	8601.680	8601.680	8601.680	370	
Partial mounting plate	Height 775 mm	1	8614.675	8614.675	8614.675	8614.675	8614.675	8614.675	448	
Component shelf, pull-out		1	6902.960	6902.980	6902.960	6902.960	6902.960	6902.980	480	
Drawer tray		1	6902.700	6902.700	6902.700	6902.700	6902.700	6902.700	481	
Paper removal flap		1	6903.200	6903.200	6903.200	6903.200	6903.200	6903.200	615	
Socket strips						see page 505				
Alternative lock systems						see page 412				



**System accessories** Page 355 **Comfort Panel** Page 116 **Optipanel** Page 118 **TFT monitor** Page 606

Compact enclosure, ready to connect.  
Standard commercially available tower PCs, up to W/H/D: 250 x 530 x 600 mm (max. 20 kg) may be attached securely to the base screw fastened to the door using the retaining strap supplied loose. The rear interfaces of the PC are readily accessible with the door open. Because the socket strip and fan-and-filter unit are already pre-installed, the enclosure is ready for immediate use.

**Roof prepared for mounting**

- Worktop IW 6902.310
- Beneath surfaces

**Base prepared for mounting**

- Cast feet IW 6902.920
- On surfaces

**Material:**

- Enclosure: Sheet steel
- Door: Sheet steel
- Design strips: Aluminium

**Surface finish:**

- Enclosure: Powder-coated, textured paint
- Door: Powder-coated

**Colour:**

- Enclosure: RAL 7035
- Door: RAL 7015
- Design strips: RAL 7035

**Protection category:**

IP 54 to IEC 60 529, complies with NEMA 12 (in conjunction with connector gland SZ 2400.300/.500 supplied loose)

**Supply includes:**

- Enclosure of all-round solid construction
- R/h door hinge
- Door with base screw-fastened on the inside
- Side cam lock
- Rear panel with two cut-outs for use of the connector gland SZ 2400.300/.500 supplied loose
- Cable gland M20, brass, nickel-plated
- Outlet filter fitted in left side panel
- Fan-and-filter unit fitted in the right side panel, door-operated switch, supply socket for 230 V power supply, socket strip with 3 sockets and overvoltage protection



**Also required:**

Connection cable for infeed, see page 495.

Photo shows a configuration example with equipment not included in the scope of supply.

## Enclosure for tower PC

Width mm	Packs of	760	Page
Height mm		760	
Depth mm		300	
<b>Model No. IW</b>	1	<b>6900.300</b>	
Weight (kg)		55	
<b>Accessories</b>			
Cast feet	2	6902.920	371
Twin castors	1 set	7495.000	374
Worktop without handle	1	6902.310	148
Enclosure attachment, tilting, base mounting	1	6902.640	143
Optipanel for TFT monitor 17"	1	6380.040	118
TFT monitor 17" with safety glass screen	1	6450.020	606
Alternative lock systems		see page 413	

# Industrial Workstations



**System accessories** Page 355 **Comfort Panel** Page 116 **Optipanel** Page 118 **TFT monitor** Page 606

### Material:

- Enclosure, roof, drawer tray, designer door, rear wall and rear door: Sheet steel
- Worktop: Chipboard: Plastic-laminated on both sides (edging)
- Aluminium handle: Powder-coated

### Surface finish:

Enclosure: Dipcoat-primed, powder-coated on the outside, textured paint

### Colour:

- Enclosure, worktop: RAL 7035
- Worktop edge strip: RAL 7015
- Worktop handle: RAL 9006

### Protection category:

See table.

### Supply includes:

Available on the Internet.

### Detailed drawing:

Available on the Internet.

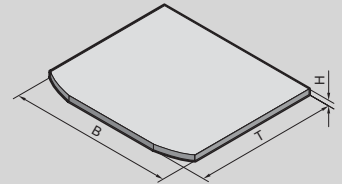
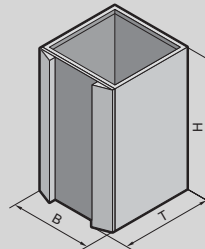
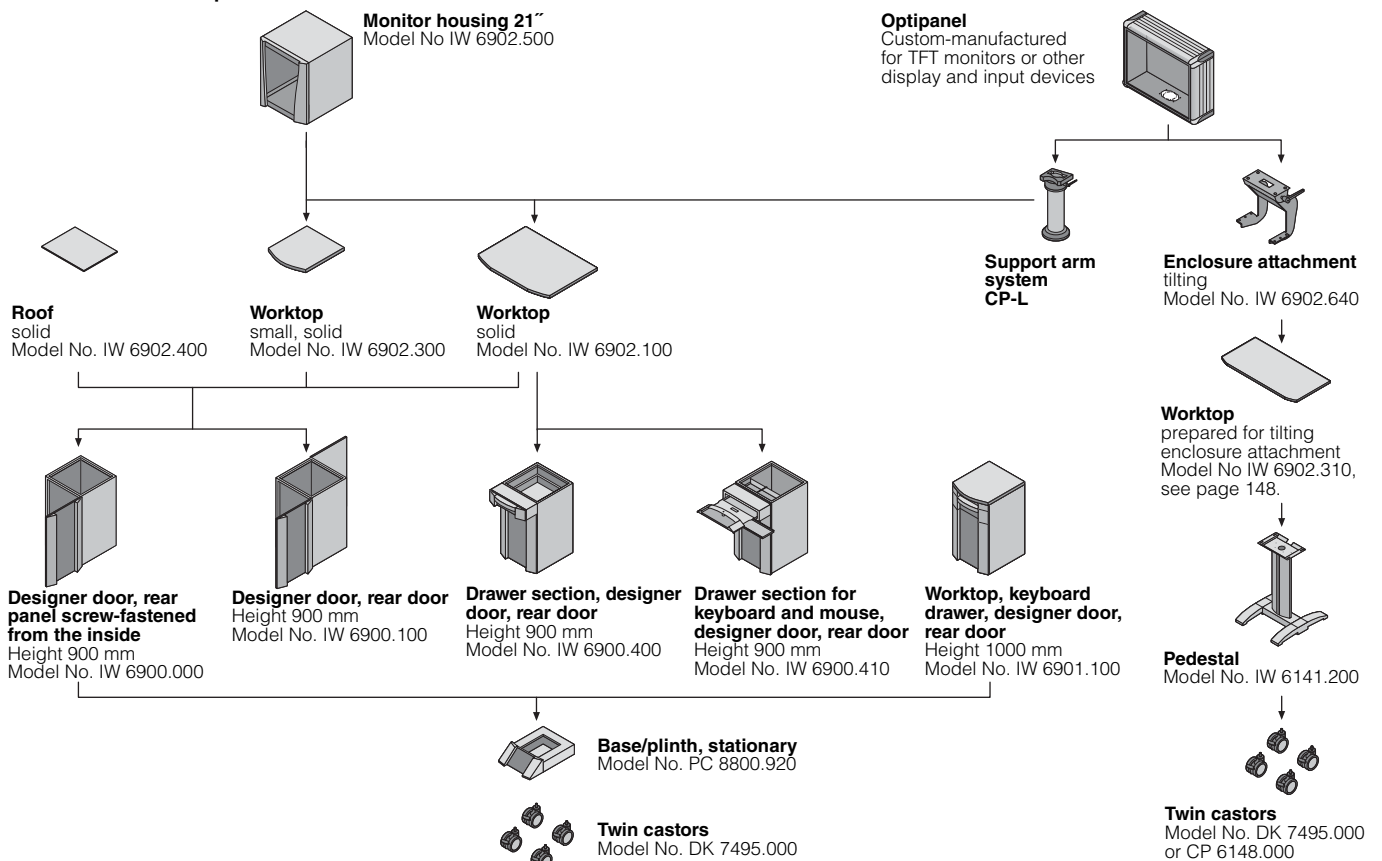

Photo shows a configuration example with equipment not included in the scope of supply.

## Combination options



## IW enclosures and worktops

Enclosure										Page	
Design					Designer door, rear panel screw-fastened from the inside	Designer door, rear door	Drawer section, designer door, rear door	Drawer section for keyboard and mouse, designer door, rear door	Worktop, keyboard drawer, designer door, rear door		
Width (B) mm					600	600	600	600	600		
Height (H) mm					900	900	900	900	1000		
Depth (T) mm					600	600	600 (890)	600 (890)	645		
Weight kg					54,9	59,9	73	73	91		
Model No. IW					<b>6900.000</b>	<b>6900.100</b>	<b>6900.400</b>	<b>6900.410</b>	<b>6901.100</b>		
Protection category					IP 55 to IEC 60 529, complies with NEMA 12		IP 54 to IEC 60 529, complies with NEMA 12				
	Width (B) mm	Height (H) mm	Depth (T) mm	Weight kg	Model No. IW						
<b>Worktops</b>											
	610	38	645	11.6	<b>6902.300</b>	<b>6902.300</b>	–	–	■		
	1000	38	895	24	<b>6902.100</b>	<b>6902.100</b>	<b>6902.100</b>	<b>6902.100</b>	–		
<b>Roof</b>											
	600	13	640	7.4	<b>6902.400</b>	<b>6902.400</b>	–	–	–		
<b>Monitor housing</b>											
	600	600	600	42.5	<b>6902.500</b>	<b>6902.500</b>	<b>6902.500</b>	<b>6902.500</b>	–		
<b>Accessories</b>					Packs of						
Base/plinth, stationary					1	8800.920	8800.920	8800.920	8800.920	8800.920	366
Cross member, adjustable					2	8601.680	8601.680	8601.680	8601.680	–	370
Twin castors					1 set	7495.000	7495.000	7495.000	7495.000	7495.000	374
Handle adaptor for comfort handle					1	8611.300	8611.300	–	–	–	402
Cable gland					1	6902.770	6902.770	6902.770	6902.770	6902.770	522
Mounting plate for enclosure width 600 mm					1	8614.675	8614.675	8614.675	8614.675	8614.680	448
Component shelf, static installation					1	8800.900	8800.900	8800.900	8800.900	8800.900	481
Component shelf, pull-out					1	6902.960	6902.960	6902.960	6902.960	6902.960	480
Drawer tray					1	6902.700	6902.700	6902.700	6902.700	6902.700	481
Adaptor section 482.6 mm (19")					1	8613.070	8613.070	8613.070	8613.070	–	551
Paper removal flap					1	6903.200	6903.200	6903.200	6903.200	6903.200	615
Enclosure attachment, tilting								see page 143			
Support arm systems								see page 125			
Operating housing								see page 120			

■ Included with the supply.





# Operating housings/support arm systems/stand systems

## Comfort Panel

Benefits at a glance.....	115
Comfort Panel.....	116
Comfort Panel, configuration examples .....	117

## Optipanel

Benefits at a glance.....	115
Optipanel.....	118
Optipanel, configuration examples .....	119

## Operating housings

Compact Panel.....	120
Command panel housing with door .....	121
Operating housing with handle strips .....	122
Operating housing with display panel front .....	123

## Support arm systems

Support arm systems, overview .....	125
Support arm system CP-S, steel .....	127
Support arm system CP-L .....	131
Support arm system CP-C.....	135
Support arm system CP-XL.....	139
Support arm systems, accessories .....	142

## Stand systems

Pedestal, modular .....	147
Pedestal, complete.....	148
Pillar, small .....	149
Pillar .....	150
Accessories.....	151



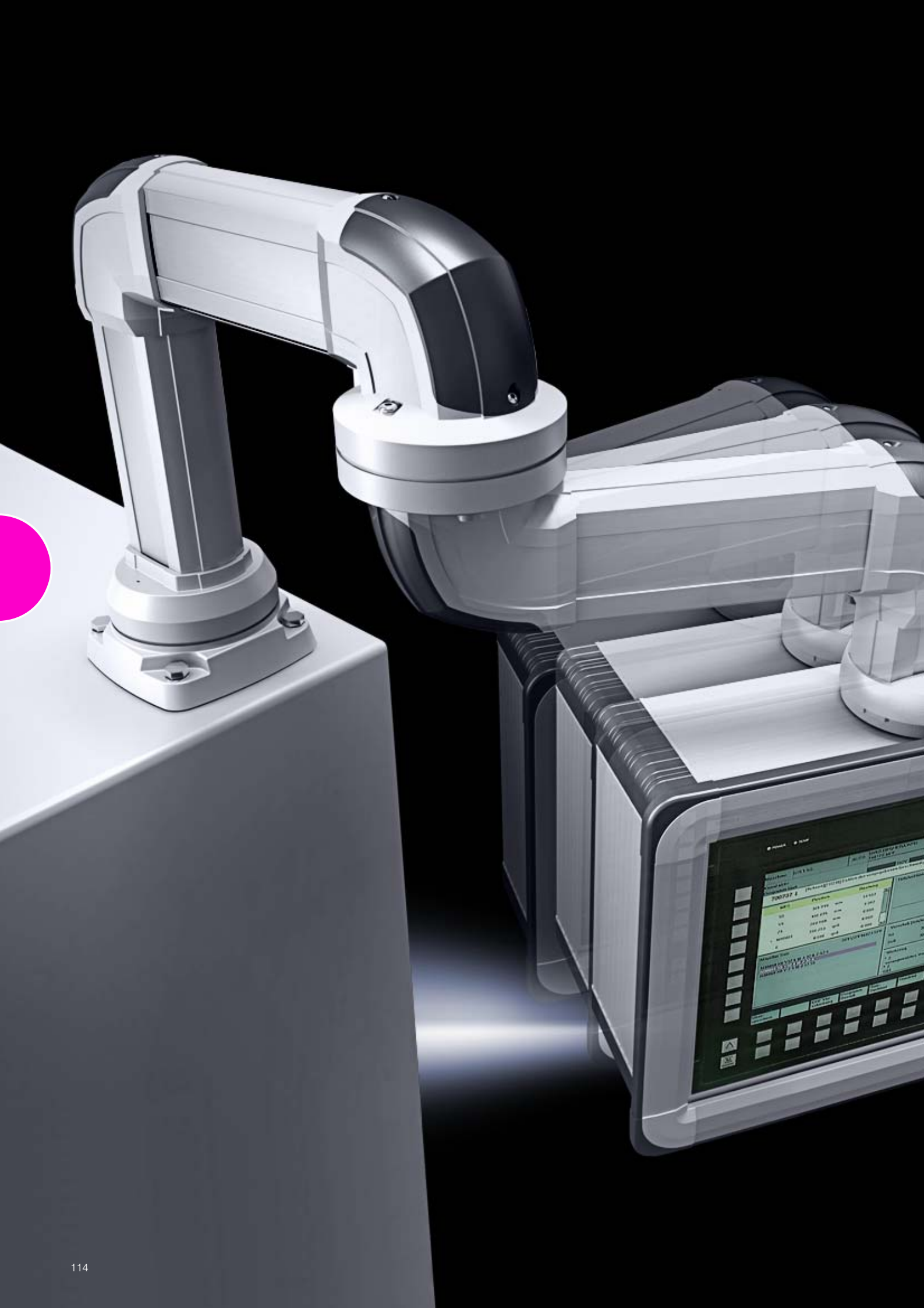

# Comfort Panel/Optipanel

## Benefits at a glance

- Aluminium enclosure, high thermal conductivity for optimum passive heat dissipation
- Low weight coupled with high stability
- Protection category IP 65
- Compatible with all Rittal stand and support arm systems

## The choice is yours

### Standard range

- Standard variants offering outstanding value for money and short delivery times
- Easy, fast and reliable selection
- For front panel installations, tailored to the most common operating solutions

Comfort Panel, see page 116.

Optipanel, see page 118.

### Configurable special solutions

- Individual sizes, also for the direct installation of panels with no front plate
- Complete solution diversity for virtually all applications
- Maximum flexibility in design and function

The command panel configurator determines the most suitable enclosure for your application based on user-specific parameters.

**More detailed information can be found at: [www.rittal.com](http://www.rittal.com)**



# Comfort Panel



System accessories Page 355 Support arm systems Page 125 Stand systems Page 147 Industrial Workstations Page 110

## Material:

- Enclosure: Extruded aluminium section
- Corner pieces: Die-cast zinc
- Corner protectors: Plastic

## Colour:

- Enclosure: Natural-anodised
- Corner pieces: RAL 7035
- Corner protectors: Similar to RAL 7024

## Protection category:

IP 65 to IEC 60 529

## Supply includes:

Seals and assembly parts for front panels.

## Detailed drawings:

Available on the Internet.

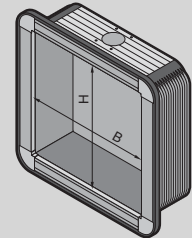

For front panel width (B) mm	Packs of	520			520			520			Page
For front panel height (H) mm		400			500			600			
Installation depth mm		74	152	191	74	152	191	74	152	191	
<b>Model No. CP<sup>4)</sup></b>	1	<b>6372.541</b>	<b>6372.542</b>	<b>6372.543</b>	<b>6372.551</b>	<b>6372.552</b>	<b>6372.553</b>	<b>6372.561</b>	<b>6372.562</b>	<b>6372.563</b>	
Weight (kg)		7.8	11.7	13.8	8.8	12.3	15.2	9.7	13.5	16.7	

## Design

Support arm connection CP-L, □ 120 x 65 mm <sup>1)</sup>		■	-	-	■	-	-	■	-	-	
Support arm connection CP-L, Ø 130 mm <sup>1)</sup>		-	■	■	-	■	■	-	■	■	
Hinged rear panel with screw lock		■	-	-	■	-	-	■	-	-	
Hinged rear panel with cam <sup>2)</sup>		-	■	-	-	■	-	-	■	-	
Screw-fastened rear panel <sup>3)</sup>		-	-	■	-	-	■	-	-	■	

## Accessories

Front panel	1	6028.014	6028.014	6028.014	6028.015	6028.015	6028.015	6028.016	6028.016	6028.016	604
Handle set, horizontal	1	6375.000	6375.000	6375.000	6375.000	6375.000	6375.000	6375.000	6375.000	6375.000	600
Handle set, vertical	2	6375.040	6375.040	6375.040	6375.050	6375.050	6375.050	6375.060	6375.060	6375.060	600
Mounting bracket for interior installation	4	6205.100	6205.100	6205.100	6205.100	6205.100	6205.100	6205.100	6205.100	6205.100	470
Spring nut M5	50	6108.000	6108.000	6108.000	6108.000	6108.000	6108.000	6108.000	6108.000	6108.000	478
Earthing plate	1	2570.500	2570.500	2570.500	2570.500	2570.500	2570.500	2570.500	2570.500	2570.500	502

<sup>1)</sup> Top or bottom, by rotating the enclosure.

<sup>2)</sup> With 3 mm double-bit lock insert, may be exchanged for 41 mm lock inserts, version C, see page 421, plastic handles and T handles, version C, see page 420.

<sup>3)</sup> Enclosure hinged at the front with side double-bit lock insert, may be exchanged for 41 mm lock inserts, version C, see page 421, plastic handles and T handles, version C, see page 420.

<sup>4)</sup> Configuration examples, see page 117.

## Configuration examples

Front panel height mm	Cut-out dimensions						
400							
	W (B) = 484 mm H = 364 mm 1 = 18 mm all-round for attaching the adaptor plate						
500							
	W (B) = 484 mm H = 464 mm 1 = 18 mm all-round for attaching the adaptor plate						
600							
	W (B) = 484 mm H = 564 mm 1 = 18 mm all-round for attaching the adaptor plate						

Free space, available for individual installed equipment such as rows of switches etc.

HE = U



## Rittal Australia

RITTAL Pty. Ltd.  
 130 – 140 Parraweena Road  
 Miranda NSW 2228  
 Phone: +61 (2) 9525 2766  
 Fax: +61 (2) 9525 2888  
 E-mail: [info@rittal.com.au](mailto:info@rittal.com.au) • [www.rittal.com.au](http://www.rittal.com.au)

# Optipanel



**System accessories** Page 355 **Support arm systems** Page 125 **Stand systems** Page 147 **Industrial Workstations** Page 110

## Material:

- Enclosure:  
Extruded aluminium section
- Corner pieces:  
Die-cast zinc
- Corner protectors:  
Plastic

## Colour:

- Enclosure:  
Natural-anodised
- Corner pieces:  
RAL 7035
- Corner protectors:  
Similar to RAL 7024

## Protection category:

IP 65 to IEC 60 529

## Supply includes:

Seals and assembly parts for front panels.

## Detailed drawings:

Available on the Internet.

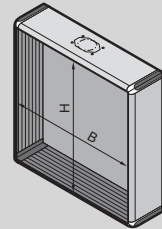

For front panel width (B) mm	Packs of	430	482.6	482.6	520	520	520	520	520	520	Page
For front panel height (H) mm		343	310.3	354.8	400	500	600				
Installation depth mm		100	100	100	100	150	100	150	100	150	
<b>Model No. CP</b>	1	<b>6380.020<sup>1)</sup></b>	<b>6380.000</b>	<b>6380.040<sup>1)</sup></b>	<b>6380.400<sup>2)</sup></b>	<b>6380.410</b>	<b>6380.500<sup>2)</sup></b>	<b>6380.510<sup>2)</sup></b>	<b>6380.600<sup>2)</sup></b>	<b>6380.610<sup>2)</sup></b>	
Weight (kg)		5.3	6.2	6.6	5.8	7.3	6.6	8.3	7.3	9.2	

## Design

Support arm connection CP-L, □ 120 x 65 mm <sup>3)</sup>		■	■	■	■	-	■	-	■	-	
Support arm connection CP-L, ∅ 130 mm <sup>3)</sup>		-	-	-	-	■	-	■	-	■	
Hinged rear panel <sup>4)</sup>		■	■	■	■	■	■	■	■	■	

## Accessories

Front panel	1	-	6028.010	-	6028.014	6028.014	6028.015	6028.015	6028.016	6028.016	604
Handle set, horizontal	1	-	6385.010	6385.010	6385.000	6385.000	6385.000	6385.000	6385.000	6385.000	600
Handle set, vertical	2	-	-	-	6385.040	6385.040	6385.050	6385.050	6385.060	6385.060	600
Mounting bracket for interior installation	4	6205.100	6205.100	6205.100	6205.100	6205.100	6205.100	6205.100	6205.100	6205.100	470
Mounting bracket	4	4597.000	4597.000	4597.000	4597.000	4597.000	4597.000	4597.000	4597.000	4597.000	470
Earthing plate	1	2570.500	2570.500	2570.500	2570.500	2570.500	2570.500	2570.500	2570.500	2570.500	502
Spring nut M5	50	6108.000	6108.000	6108.000	6108.000	6108.000	6108.000	6108.000	6108.000	6108.000	478

<sup>1)</sup> To fit TFT monitors, see page 606.

<sup>2)</sup> Configuration examples, see page 119.

<sup>3)</sup> Top or bottom, by rotating the enclosure.

<sup>4)</sup> With 3 mm double-bit lock insert, may be exchanged for 41 mm lock inserts, version C, see page 421, plastic handles and T handles, version C, see page 420.



To fit **desktop TFT up to 20.1"** with rear connection

- VESA 75
- VESA 100

**Model No. CP 6380.050**

## Configuration examples

Front panel height mm	Cut-out dimensions						
400							
	W (B) = 484 mm H = 364 mm <b>1</b> = 18 mm all-round for attaching the adaptor plate						
500							
	W (B) = 484 mm H = 464 mm <b>1</b> = 18 mm all-round for attaching the adaptor plate						
600							
	W (B) = 484 mm H = 564 mm <b>1</b> = 18 mm all-round for attaching the adaptor plate						

↑ ↓ Free space, available for individual installed equipment such as rows of switches etc.

HE = U



## Rittal Belgium

RITTAL nv/sa  
 Industrieterrein E17/3206 · Stokkelaar 8  
 B-9160 Lokeren  
 Phone: +32 (0) 9 353 9111  
 Fax: +32 (0) 9 355 6862  
 E-mail: info@rittal.be · www.rittal.be

# Compact Panel



**System accessories** Page 355 **Support arm systems** Page 125 **Stand systems** Page 147

For small operating units built into front panels. The front panel is inserted from the rear and secured with screw clamps. Special front panels with a material thickness of between 2 and 6 mm are possible. Rear panel optionally hinged on the left or right.

**Material:**

- Roof tray, base tray, rear panel: Aluminium
- Side parts: Extruded aluminium section
- Screw cover: Plastic

**Surface finish:**

- Roof tray, base tray, side parts: Powder-coated
- Rear panel: Natural-anodised

**Colour:**

RAL 7024

**Protection category:**

IP 65 to IEC 60 529

**Supply includes:**

- Roof tray
- Base tray
- Rear panel
- Side parts
- Screw cover
- Seal and screw clamp

**Detailed drawings:**

Available on the Internet.

Width mm	Packs of	241	241	315	315	Page
Height mm		238	388	238	388	
Depth mm		87	87	87	87	
To fit	Front panel width mm	178	178	252	252	
	Front panel height mm	200	350	200	350	
<b>Model No. CP</b> (with support arm connection CP-S)	1	<b>6340.000</b>	<b>6340.100</b>	<b>6340.300</b>	<b>6340.400</b>	
Weight (kg)		2.8	3.8	3.4	4.5	

<b>Accessories</b>						
Front panel, 3.0 mm aluminium, natural-anodised	1	6028.500	6028.510	6028.530	6028.540	604
Wall mounting bracket, vertically hinged	1 set	6341.000	6341.000	6341.000	6341.000	442
Cover plate for support arm connection CP-S	1	6505.200	6505.200	6505.200	6505.200	604
Spring nut M5	50	6108.000	6108.000	6108.000	6108.000	478

To order different heights for front panel width:  
 - 178 mm use Model No.: CP 6342.109  
 - 252 mm use Model No.: CP 6342.209  
 and additionally specify the front panel height. Extended delivery times.



# Command panel housing with door



System accessories Page 355 Support arm systems Page 125 Stand systems Page 147 Command panel housing with door, stainless steel Page 167

## Material:

- Enclosure and door: Sheet steel
- Handle strips: Aluminium
- Cover caps: Plastic

## Surface finish:

- Enclosure and door: Dipcoat-primed, powder-coated on the outside, textured paint
- Handle strips: Powder-coated

## Colour:

- Enclosure and door: RAL 7035
- Handle strips and cover caps: RAL 5018

## Protection category:

IP 55 to IEC 60 529

## Supply includes:

- Enclosure with cut-out and reinforcement for support arm system CP-L, Ø 130 mm
- Cam lock with double-bit insert
- Door with sealing frame
- Side handle strips and cover caps

## Note:

The support arm connection and door hinge may be swapped over by rotating the enclosure.

## Approvals:

- UL
- cUL

## Detailed drawings:

Available on the Internet.

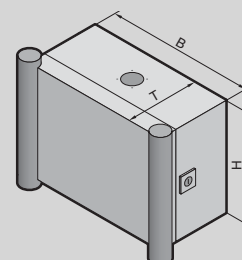

Width (B) mm	Packs of	300	300	300	400	400	500	Page
Height (H) mm		200	300	400	300	400	500	
Depth (T) mm		180	180	180	180	180	180	
Model No. CP	1	<b>6534.000</b>	<b>6535.000</b>	<b>6537.000</b>	<b>6536.000</b>	<b>6538.000</b>	<b>6544.000</b>	
Weight (kg)		5.5	7.1	8.4	8.4	10.6	14.5	

## Accessories

	AE type		1032.500	1033.500	1034.500	1030.500	1380.500	1050.500	44
Matching mounting plate	<b>Model No.<sup>2)</sup></b>		0271.324	0271.926	0271.927	0274.131	0271.548	0271.333	-
Support rails <sup>1)</sup>	Model No.	10	2316.000	2316.000	2316.000	2317.000	2317.000	2318.000	467
Alternative lock systems		With 3 mm double-bit lock insert, may be exchanged for 41 mm lock inserts, version C, see page 421, plastic handles and T handles, version C, see page 420.							

<sup>1)</sup> Only with vertical attachment of punched rail 23 x 23 mm, see page 463.

<sup>2)</sup> Extended delivery times.



## Rittal Sweden

RITTAL Scandinavian ab  
 Rittalgatan 1 · SE-262 73 Ängelholm  
 Phone: +46 (431) 44 26 00  
 Fax: +46 (431) 44 26 44  
 E-mail: info@rittal.se · www.rittal.se

# Operating housing with handle strips



System accessories Page 355 Support arm systems Page 125 Stand systems Page 147 Command panel housing with door, stainless steel Page 167

## Material:

- Enclosure and door: Sheet steel
- Handle strips: Aluminium
- Cover caps: Plastic

## Surface finish:

- Enclosure and door: Dipcoat-primed, powder-coated on the outside, textured paint
- Handle strips: Powder-coated

## Colour:

- Enclosure and door: RAL 7035
- Handle strips and cover caps: RAL 7030

## Protection category:

IP 55 to IEC 60 529

## Supply includes:

- Enclosure with cut-out and reinforcement for support arm system CP-L, Ø 130 mm
- Mounting angles spot welded at the sides
- Front with maximum cut-out, covered with easily machinable 3 mm aluminium front panel
- Side handle strips with cover caps
- Rear door with r/h hinge
- Cam lock with double-bit insert

## Note:

The support arm connection and door hinge may be swapped over by rotating the enclosure.

## Approvals:

- UL
- cUL

## Detailed drawings:

Available on the Internet.

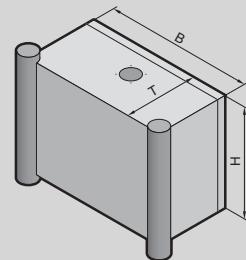

Width (B) mm	Packs of	300	380	380	500	600	Page
Height (H) mm		200	300	380	500	380	
Depth (T) mm		155	210	210	210	210	
Model No. CP	1	<b>6540.200<sup>1)</sup></b>	<b>6531.200</b>	<b>6530.200</b>	<b>6532.200</b>	<b>6533.200</b>	
Weight (kg)		4.9	9.3	10.2	15.4	14.6	

## Accessories

Support strips for attaching to the mounting angles of the side panel	20	-	-	4594.000	4309.000	4594.000	426
Rail for interior installation	4	-	2373.210	2373.210	2373.210	2373.210	459
Mini comfort handle	1	-	-	2537.0X0	2537.0X0	2537.0X0	418
Alternative lock systems	With 3 mm double-bit lock insert, may be exchanged for 27 mm lock inserts, version A, see page 421, lock cylinder, plastic handles and T handles, version B, see page 420.						

<sup>1)</sup> Support arm connection and door hinge at the bottom.



## Rittal Spain

RITTAL Dispres S.A.  
 Mas Baiona, 40  
 Polígono Industrial Can Roqueta  
 08202 Sabadell (Barcelona)  
 Phone: +34 937 001 300  
 Fax: +34 937 001 301  
 E-mail: info@rittal.es · www.rittal.es

# Operating housing with display panel front



System accessories Page 355 Support arm systems Page 125 Stand systems Page 147 Command panel housing with door, stainless steel Page 167

#### Material:

- Enclosure and door: Sheet steel
- Frame and front panel: Aluminium

#### Surface finish:

- Enclosure and door: Dipcoat-primed, powder-coated on the outside, textured paint
- Frame and front panel: Natural-anodised

#### Colour:

RAL 7035

#### Protection category:

IP 54 to IEC 60 529

#### Supply includes:

- Enclosure without gland plate
- Mounting angles spot welded at the sides
- With maximum cut-out at the front and fitted, easily machinable 3 mm front panel with aluminium frame, with r/h hinge, screw-fastened from the inside.
- Rear door with r/h hinge
- Cam lock with double-bit insert

#### Approvals:

- UL
- cUL

#### Detailed drawings:

Available on the Internet.

Width mm	Packs of	380	380	500	600	Page
Height mm		380	600	500	600	
Depth mm		249	249	249	249	
<b>Model No. CP</b>	1	<b>6442.500</b>	<b>6462.500</b>	<b>6552.500</b>	<b>6662.500</b>	
Weight (kg)		9.5	13.4	18.0	19.6	
Cam lock		1	2	2	2	

Accessories						
Enclosure reinforcement with support arm cut-out CP-L	1	6143.210	6143.210	6143.210	–	151
Enclosure reinforcement with support arm cut-out CP-XL	1	–	–	–	6503.000	151
Rail for interior installation	4	2373.210	2373.210	2373.210	2373.210	459
Mini comfort handle	1	2537.0X0	2537.0X0	2537.0X0	2537.0X0	418
Alternative lock systems	With 3 mm double-bit lock insert, may be exchanged for 27 mm lock inserts, version A, see page 421, lock cylinder, plastic handles and T handles, version B, see page 420.					



## Rittal South Korea

RITTAL Co., Ltd.  
 Seoul Head Office  
 3rd Floor Asaan Venture Tower B/D  
 315-6 Yangjae-Dong  
 Seocho-Gu · Seoul 137-896 · Korea  
 Phone: +82 (0)2-577-6525  
 Fax: +82 (0)2-577-6526  
 E-mail: rittal@rittal.co.kr · www.rittal.co.kr



# Support arm systems

## Support arm system CP-S

Overview of components.....	127
Support section CP-S.....	128
Support arm system CP-S, components.....	129

## Support arm system CP-L

Overview of components.....	131
Support section CP-L.....	132
Support arm system CP-L, components.....	133

## Support arm system CP-C

Overview of components.....	135
Support section CP-C.....	136
Support arm system CP-C, components.....	137

## Support arm system CP-XL

Overview of components.....	139
Support section CP-XL.....	140
Support arm system CP-XL, components.....	141

## Load information

Comparison of support arm systems

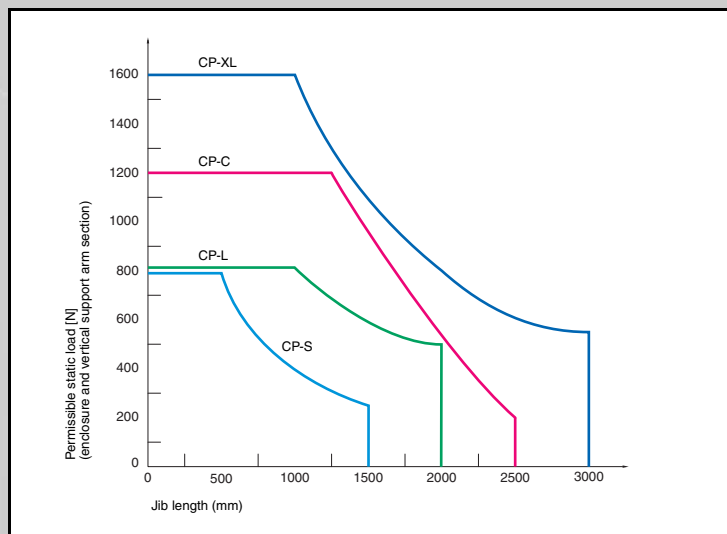

## Support arm configurator

The support arm configurator determines the correct support arm system according to user-specific parameters.

**More detailed information can be found at: [www.rittal.com](http://www.rittal.com)**

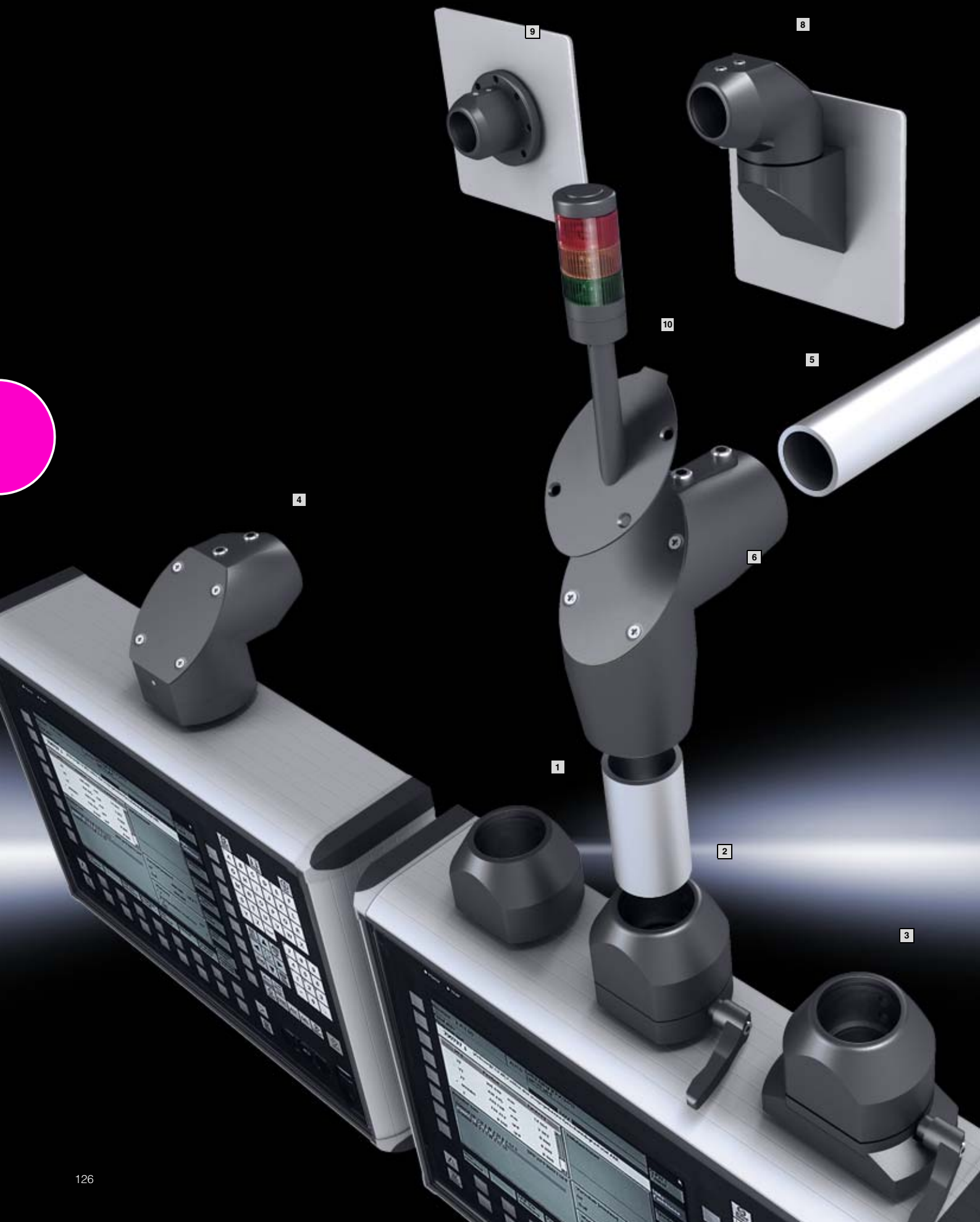

9

8

10

5

4

6

1

2

3

# Support arm system CP-S, steel

## Overview of components

- 1 Enclosure attachment CP-S  
(CP 6501.070)
- 2 Housing coupling, round CP-S  
(CP 6501.050)
- 3 Housing coupling, CP-S for support arm connection  
CP-L  $\square$  120 x 65 mm  
(CP 6501.130)
- 4 Angle coupling 90° CP-S  
(CP 6501.120)
- 5 Support section CP-S  
(CP 6501.000, .020)
- 6 Angle piece 90° CP-S  
(CP 6501.140)
- 7 Top-mounted joint CP-S  
(CP 6501.160)
- 8 Wall-mounted hinge CP-S  
(CP 6501.150)
- 9 Wall/base mounting bracket CP-S  
(CP 6501.110)
- 10 Mounting components for signal pillar  
(CP 2375.030)

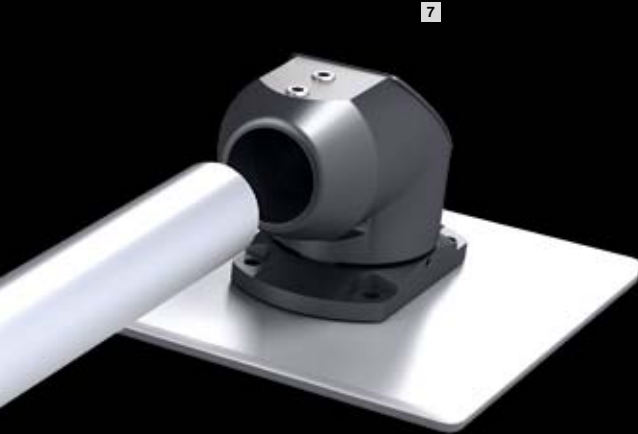

## Load information

When using CP-S in conjunction with CP-L (in the horizontal development of the system), the CP-L load diagram applies.

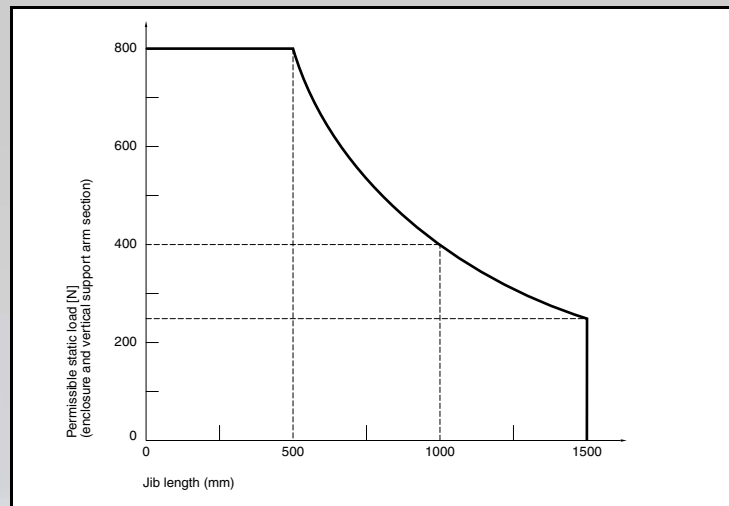

# Support arm system CP-S, steel



Comfort Panel Page 116 Optipanel Page 118 Compact Panel Page 120 Command panel housing with door Page 121 Operating housings Page 122

## Support section CP-S

Attached to the connection components via 2 clamping screws.

## Size:

- External diameter: 48.3 mm
- Wall thickness: 4.0 mm

## Material:

- Steel conduit, powder-coated

## Colour:

RAL 7035

## Supply includes:

Support section CP-S

## Note:

Stainless steel, see page 168.

## Detailed drawings:

Available on the Internet.

Integral adjustment facility

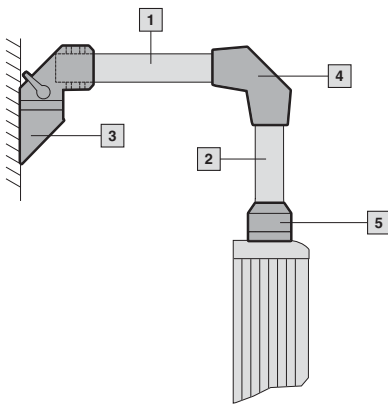

Combination with support arm system CP-L

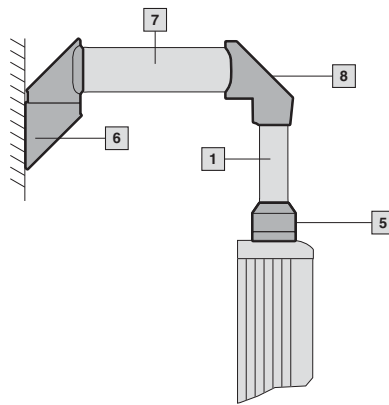



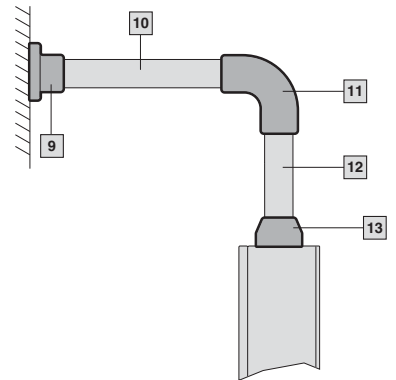





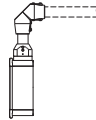

Also available in stainless steel version, see page 168

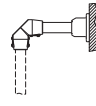
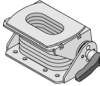

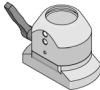
- 1 Support section CP-S, 1000 mm (CP 6501.020)
- 2 Support section CP-S, 500 mm (CP 6501.000)
- 3 Wall-mounted hinge CP-S (CP 6501.150)
- 4 Angle piece 90° CP-S (CP 6501.140)
- 5 Housing coupling CP-S (CP 6501.050)
- 6 Wall-mounted hinge CP-L (CP 6521.010)
- 7 Support section CP-L, 500 mm (CP 6511.000)
- 8 Angle adaptor CP-L to CP-S 90° (CP 6501.090)
- 9 Wall/base mounting, rigid, CP-S, stainless steel (CP 6663.000)
- 10 Support section CP-S, stainless steel, 1000 mm (CP 6660.010)
- 11 Angle piece 90°, CP-S, stainless steel (CP 6664.300)
- 12 Support section CP-S, stainless steel, 500 mm (CP 6660.050)
- 13 Housing coupling CP-S, stainless steel (CP 6664.000)

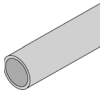

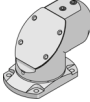
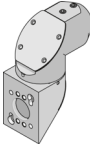
# Support arm system CP-S, steel

	Rotating/tilting	Rigid	Length mm	Weight kg	Colour RAL	Enclosure section	Desk section	Wall section
								
<b>Model No. CP</b>								
 Enclosure attachment, tilting see page 145	■	-	-	0.8	7024	<b>6902.670</b>	-	-
 Enclosure attachment CP-S	-	■	-	1.0	7024	<b>6501.070</b>	-	-
 Housing coupling, round CP-S	■	-	-	1.1	7024	<b>6501.050</b>	-	-
 Housing coupling CP-S for support arm connection CP-L □ 120 x 65 mm	■	-	-	1.5	7024	<b>6501.130</b>	-	-
 Angle coupling 90° CP-S	■	-	-	1.6	7024	<b>6501.120</b>	-	-
 Support section CP-S	-	-	500 1000	2.1 4.2	7035 7035	<b>6501.000</b> <b>6501.020</b>		
 Angle piece 90° CP-S	-	■	-	1.1	7024	<b>6501.140</b>	-	<b>6501.140</b>
 Mounting component for signal pillar see page 623	-	■	-	0.3	7024	<b>2375.030</b>	-	-
 Top-mounted joint CP-S	■	-	-	1.8	7024	-	-	<b>6501.160</b>
 Wall-mounted hinge CP-S	■	-	-	2.2	7024	-	-	<b>6501.150</b>
 Wall/base mounting bracket CP-S	-	■	-	0.7	7024	-	-	<b>6501.110</b>
<b>Accessories CP-S</b> Angle adaptor 90° CP-L to CP-S CP 6501.090								see page 146

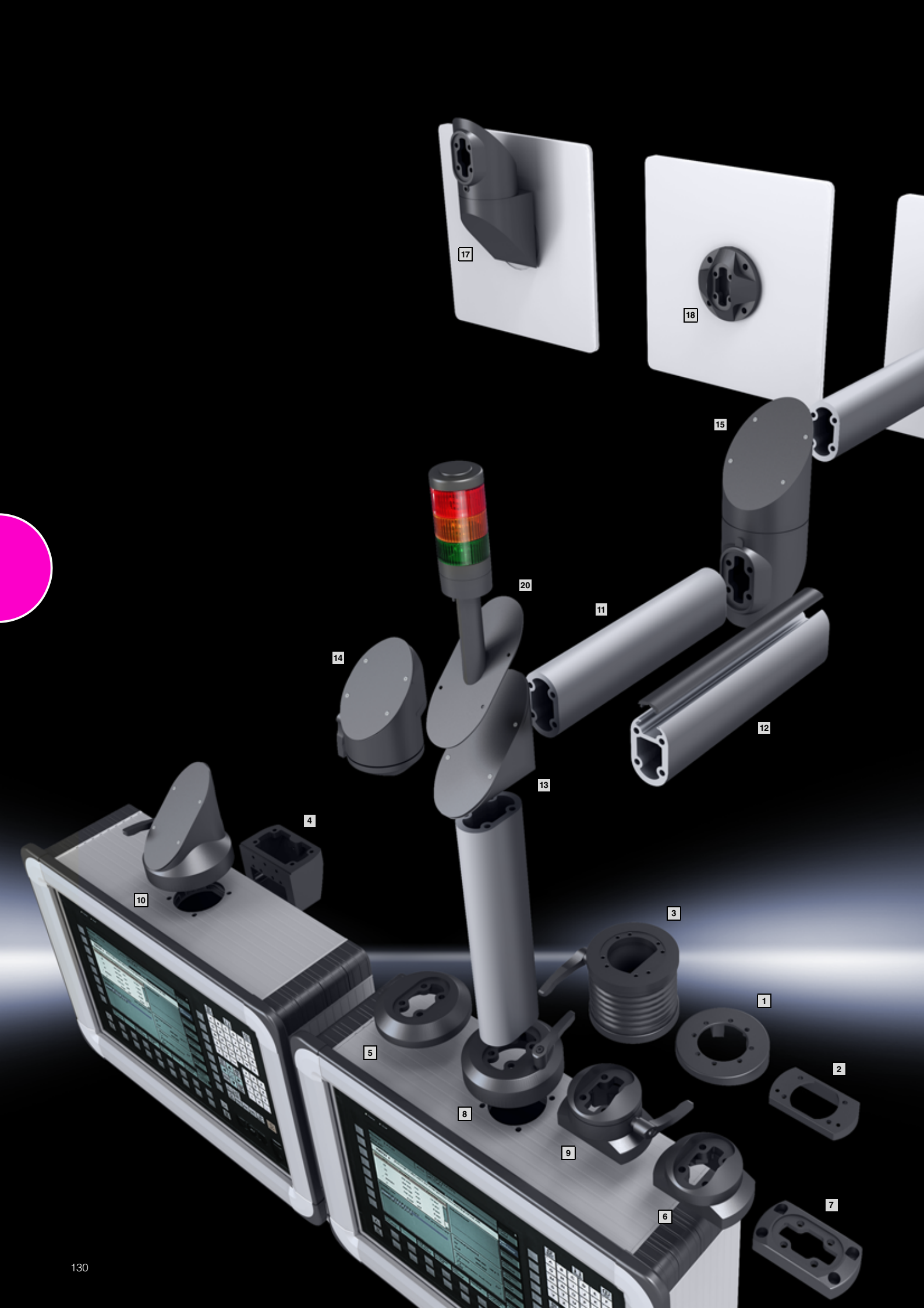

# Support arm system CP-L

## Overview of components

- 1 Tilting adaptor 10° CP-L, for support arm connection  $\varnothing$  130 mm (CP 6527.010)
- 2 Tilting adaptor 10° CP-L, for support arm connection CP-L  $\square$  120 x 65 mm (CP 6527.110)
- 3 Tilting adaptor  $\pm 45^\circ$  CP-L, for support arm connection  $\varnothing$  130 mm (CP 6529.010)
- 4 Connection console CP-L (CP 6508.010)
- 5 Enclosure attachment CP-L, for support arm connection  $\varnothing$  130 mm (CP 6525.510)
- 6 Enclosure attachment CP-L, for support arm connection CP-L  $\square$  120 x 65 mm (CP 6525.610)
- 7 Enclosure attachment, locatable CP-L, for support arm connection CP-L  $\square$  120 x 65 mm (CP 6525.210)
- 8 Housing coupling CP-L, for support arm connection  $\varnothing$  130 mm (CP 6525.010)
- 9 Housing coupling CP-L, for support arm connection CP-L  $\square$  120 x 65 mm (CP 6525.110)
- 10 Angle coupling 90° CP-L, for support arm connection  $\varnothing$  130 mm (CP 6526.010)
- 11 Support section CP-L, closed (CP 6509.000, CP 6511.000, CP 6513.000, CP 6515.000)
- 12 Support section CP-L, open (CP 6513.050)
- 13 Angle piece 90° CP-L (CP 6524.010)
- 14 Articulated joint 90° CP-L, may only be top-mounted/suspended on the enclosure side (CP 6524.210)
- 15 Intermediate hinge CP-L (CP 6523.010)
- 16 Top-mounted joint CP-L (CP 6522.010)
- 17 Wall-mounted hinge CP-L (CP 6521.010)
- 18 Wall/base mounting bracket, small CP-L (CP 6520.510)
- 19 Wall/base mounting bracket, large CP-L (CP 6520.010)
- 20 Mounting components for signal pillar (CP 2375.000, .020)

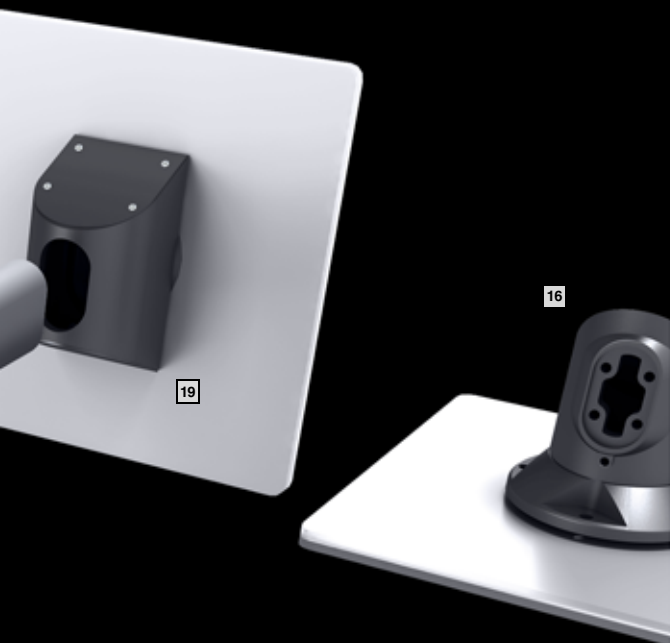

## Load information

Permissible load depending on system configuration

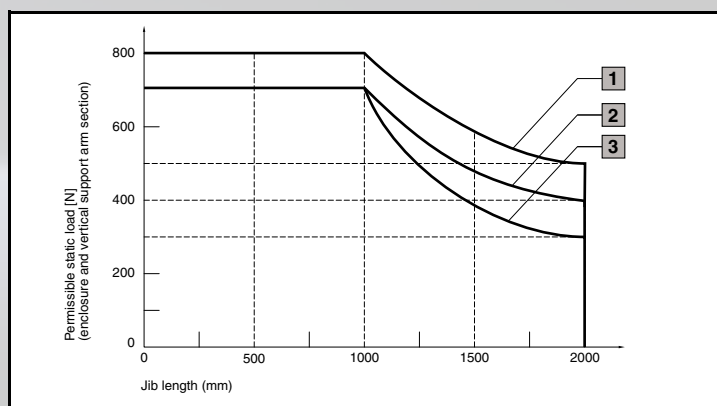

- 1 System configuration without intermediate hinge
- 2 System configuration with one intermediate hinge
- 3 System configuration with one intermediate hinge and one top-mounted/wall-mounted joint

### Note:

- Intermediate hinge CP 6523.010 should only be used once per system!
- When using the open support section, the load information is 70% of the closed support section.

# Support arm system CP-L



Comfort Panel Page 116 Optipanel Page 118 Compact Panel Page 120 Command panel housing with door Page 121 Operating housings Page 122

## Support section CP-L

Attachment to the connection components with 4 self-tapping screws in the screw channel, may be cut to any required length, no thread-tapping required.

## Size:

- External dimensions: 50 x 85 mm
- Wall thickness: 8 mm

## Material:

- Support section: Extruded aluminium section
- Cover: Plastic

## Colour:

Support section: RAL 7035

## Supply includes:

Support section CP-L

## Detailed drawings:

Available on the Internet.

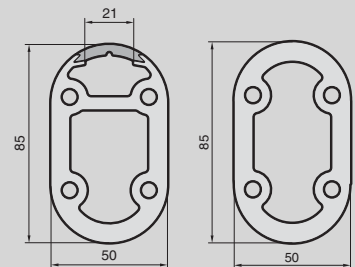

Combination with support arm systems CP-C to CP-L

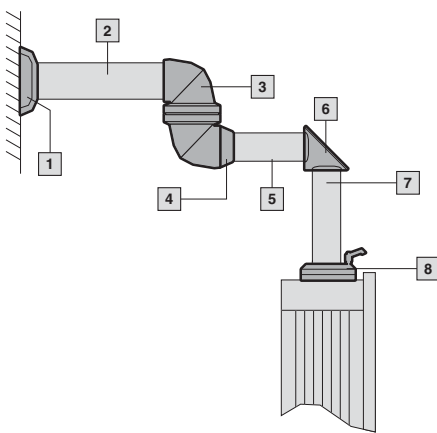

Combination with support arm systems CP-C to CP-S

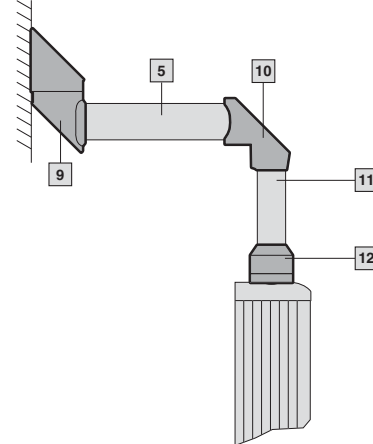





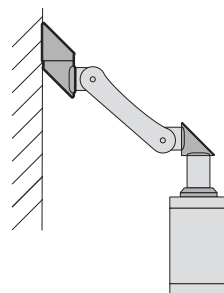
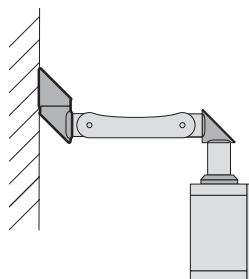
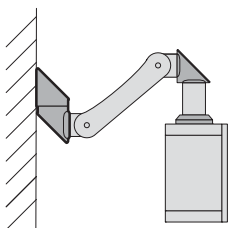





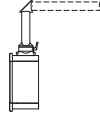

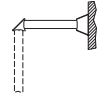



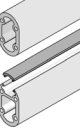

- 1 Wall/base mounting bracket CP-C, large (CP 6072.000)
- 2 Support section CP-C, 500 mm (CP 6074.100)
- 3 Intermediate hinge CP-C (CP 6071.800)
- 4 Adaptor CP-C to CP-L (CP 6071.600)
- 5 Support section CP-L (CP 6511.000)
- 6 Angle piece 90° CP-L (CP 6524.010)
- 7 Support section CP-L, 500 mm (CP 6511.000)
- 8 Housing coupling CP-L (CP 6525.010)
- 9 Wall-mounted hinge CP-L (CP 6521.010)
- 10 Angle adaptor 90° (CP 6501.090)
- 11 Support section CP-S, steel, 500 mm (CP 6501.000)
- 12 Housing coupling CP-S (CP 6501.050)

Combination with support arm, height adjustable

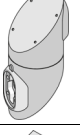

- Adjustment range up to 800 mm
- Integral stay in three stages, except for CP 6510.210
- Problem-free cable entry with connectors such as DVI, VGA, except with CP 6510.210
- Support arm, height-adjustable, see page 144

# Support arm system CP-L

	Rotating/tilting	Rigid	Length mm	Weight kg	Colour RAL	Enclosure section	Desk section	Wall section
								
<b>Model No. CP</b>								
	<b>Tilting adaptor 10° CP-L</b>							
	for support arm connection Ø 130 mm					-	■	-
	for support arm connection CP-L □ 120 x 65 mm					-	■	-
	<b>Tilting adaptor ±45° CP-L</b>							
	for support arm connection Ø 130 mm					■	-	-
	<b>Connection console CP-L</b>							
	for flat operating housings					-	■	-
	<b>Enclosure attachment CP-L</b>							
	for support arm connection Ø 130 mm					-	■	-
	for support arm connection CP-L □ 120 x 65 mm					-	■	-
	<b>Enclosure attachment, locatable CP-L</b>							
	for support arm connection CP-L □ 120 x 65 mm					-	■	-
	<b>Housing coupling CP-L</b>							
	for support arm connection Ø 130 mm					■	-	-
	for support arm connection CP-L □ 120 x 65 mm					■	-	-
	<b>Angle coupling 90° CP-L</b>							
	for support arm connection Ø 130 mm					■	-	-
	<b>Support section CP-L</b>							
	Closed					-	-	250
						-	-	500
						-	-	1000
						-	-	2000
	Open					-	-	1000
	<b>Angle piece 90° CP-L</b>							
						-	■	-
						-	-	1.4
	<b>Articulated joint 90° CP-L</b>							
						■	-	-
						-	-	1.2
	<b>Intermediate hinge CP-L</b>							
						■	-	-
						-	-	3.2
	<b>Wall/base mounting, large CP-L</b>							
						-	■	-
						-	-	1.9
	<b>Mounting component for signal pillar</b>							
	see page 623					-	■	-
						-	■	-
						0.4	9017	2375.000
						-	9017	-
						-	-	2375.020
						-	-	2375.020
	<b>Top-mounted joint CP-L</b>							
						■	-	-
						-	-	3.0
	<b>Wall-mounted hinge CP-L</b>							
						■	-	-
						-	-	3.2
	<b>Wall/base mounting bracket, small, CP-L</b>							
						-	■	-
						-	-	0.6
						-	7024	-
						-	-	-
						-	-	6520.510
<b>Accessories CP-L:</b>								
Adaptation options								see page 142
Support arm bracket CP 6519.000								see page 145
Connection plate CP 6528.210								see page 143

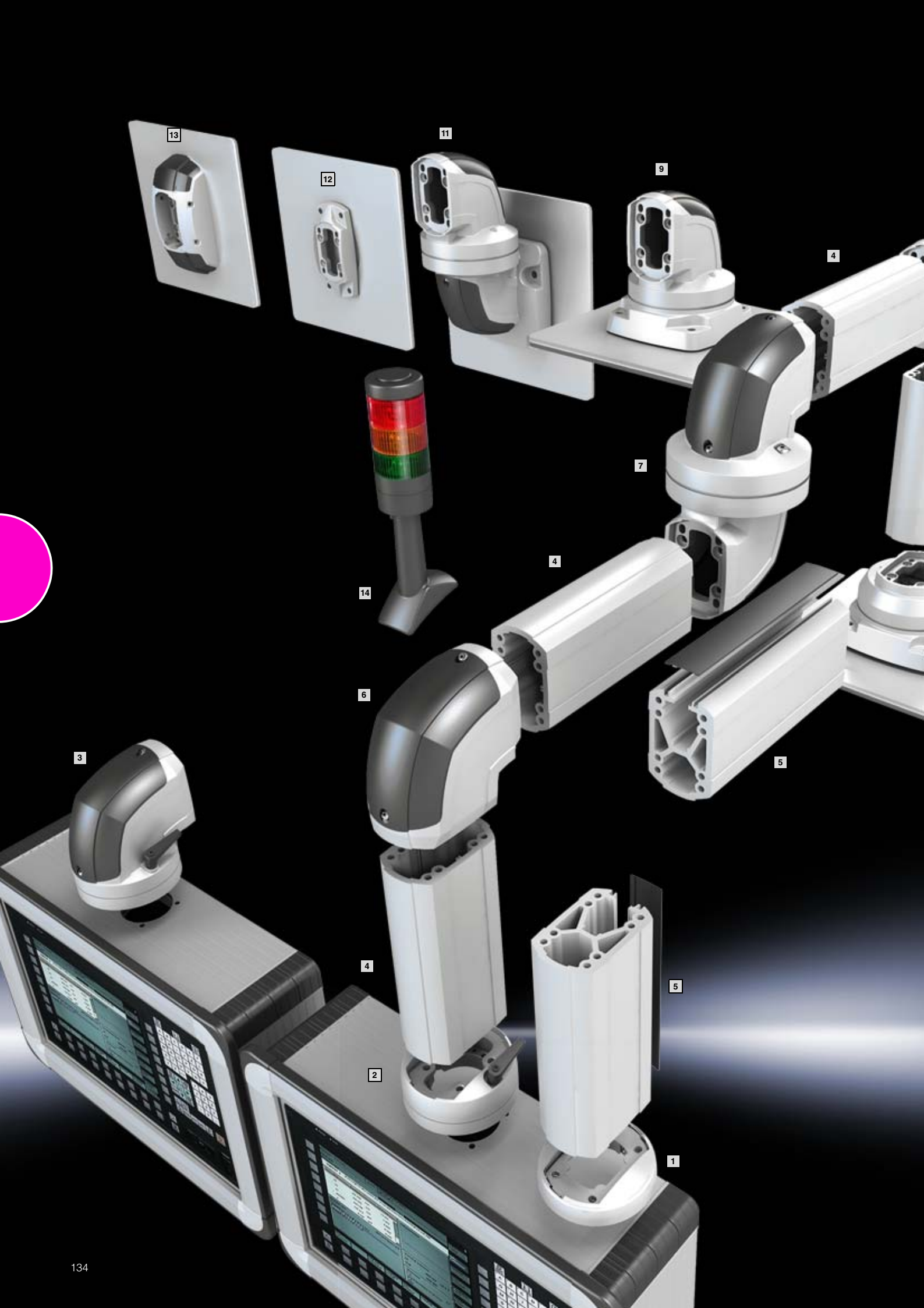

# Support arm system CP-C

## Overview of components

- 1 Enclosure attachment CP-C, for support arm connection CP-L Ø 130 mm (CP 6070.200)
- 2 Enclosure attachment CP-C, for support arm connection CP-L Ø 130 mm (CP 6070.000)
- 3 Angle coupling 90° CP-C, for support arm connection CP-L Ø 130 mm (CP 6071.200)
- 4 Support section CP-C, closed (CP 6074.000, .100, .300, .500)
- 5 Support section CP-C, open (CP 6075.100, .300, .500)
- 6 Angle piece 90° CP-C (CP 6071.400)
- 7 Intermediate hinge CP-C (CP 6071.800)
- 8 Top-mounted joint CP-C, vertical outlet (CP 6072.800)
- 9 Top-mounted joint CP-C, horizontal outlet (CP 6072.600)
- 10 Wall-mounted joint CP-C, vertical outlet (CP 6072.400)
- 11 Wall-mounted joint CP-C, horizontal outlet (CP 6072.500)
- 12 Wall/base mounting bracket, small CP-C (CP 6072.200)
- 13 Wall/base mounting bracket, large CP-C (CP 6072.000)
- 14 Mounting components for signal pillar (CP 6073.000)

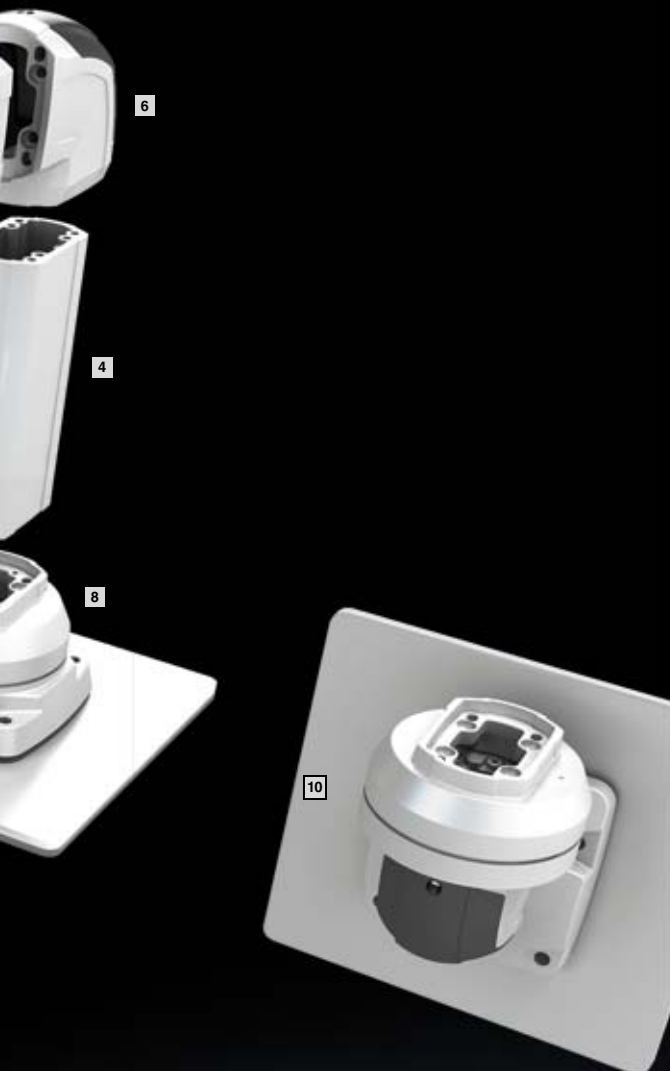

## Load information

Permissible load depending on system configuration

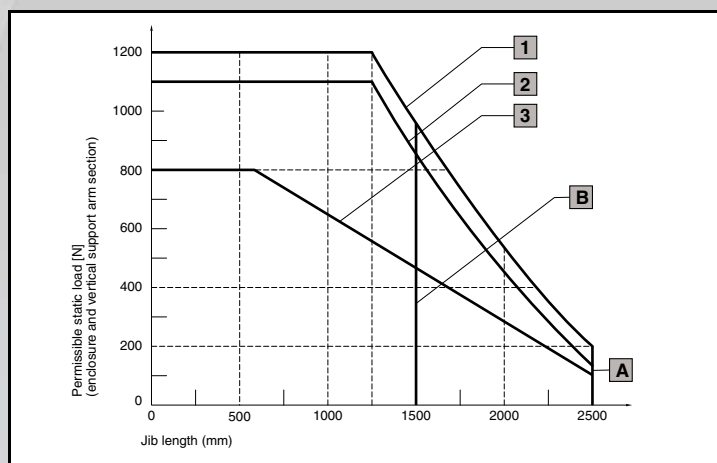

- 1 Without intermediate hinge
- 2 With intermediate hinge CP 6071.800 and closed support section
- 3 With intermediate hinge CP 6071.800 and open support section
- A Maximum system length 2500 mm for systems with horizontal outlet at the system start.
- B Maximum system length 1500 mm for systems **with vertical outlet** at the system start.

### Note:

- Wall/base mounting bracket, small CP 6072.200 must not be used in conjunction with intermediate hinge CP 6071.800!
- Intermediate hinge CP 6071.800 should only be used once per system!

# Support arm system CP-C



Comfort Panel Page 116   Optipanel Page 118   Compact Panel Page 120   Command panel housing with door Page 121   Operating housings Page 122

## Support section CP-C

Attachment to the connection components with 4 self-tapping screws in the screw channel. May be cut to any required length, no thread-tapping required.

Closed cable duct with a large cross-section.

Open cable duct for easy servicing access and for pre-assembled cables with connectors; lockable via cover section. X-shaped profile for higher load capacity, large cable routing channels.

Upper channel adequate for cables with large connectors (e.g. DVI or VGA) and available/usable throughout the entire system.

### Size:

- External dimensions: 75 x 120 mm
- Wall thickness: 6.5 mm

### Material:

- Support section: Extruded aluminium section
- Cover: Plastic

### Colour:

- Support section: RAL 7035
- Cover: RAL 7024

### Supply includes:

- Support section CP-C
- Clip-in lid (only for CP-C open)

### Detailed drawings:

Available on the Internet.

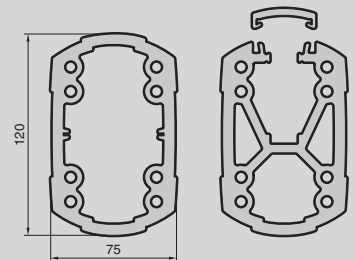

## Function

- Easily adjusted without dismantling the system
- Fast, simple assembly of the system
- Rotation range may be limited without dismantling the system





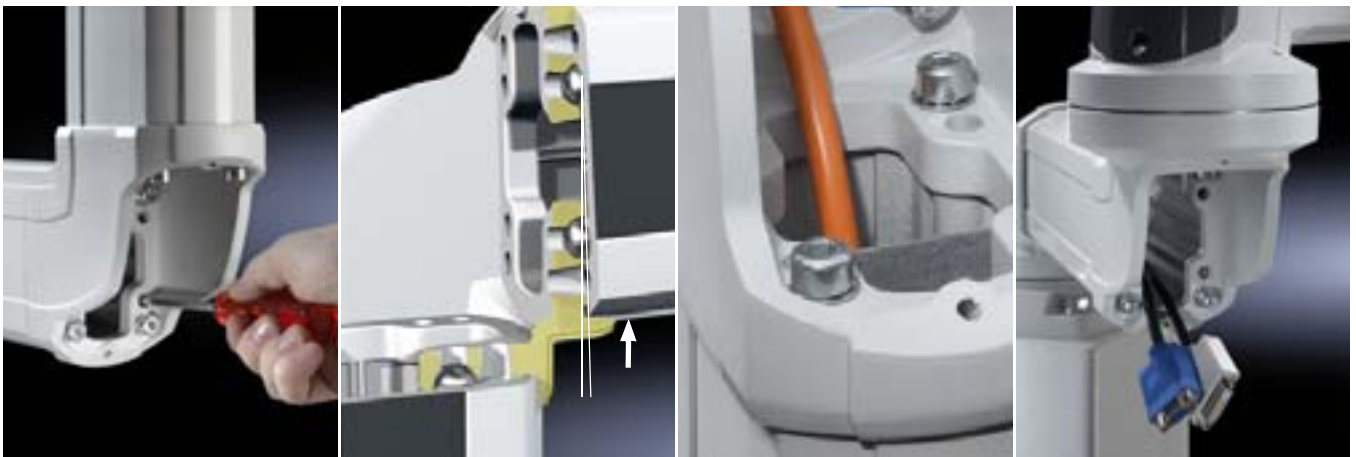



## Cable management

- Cross-section sufficient for large connectors
- Separation between data and power cables
- Removable cover for simple cable entry
- Flexible cable entry and routing options

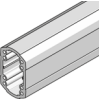
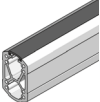

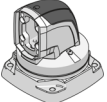

# Support arm system CP-C

	Rotating/tilting	Rigid	Length mm	Weight kg	Colour RAL	Enclosure section	Desk section	Wall section
						Model No. CP		
<b>Enclosure attachment CP-C for support arm connection CP-L Ø 130 mm</b>								
	-	■	-	0.7	7035	<b>6070.200</b>	-	-
<b>Housing coupling CP-C for support arm connection CP-L Ø 130 mm</b>								
	■	-	-	2.0	7035	<b>6070.000</b>	-	-
<b>Angle coupling 90° CP-C, for support arm connection CP-L Ø 130 mm</b>								
	■	-	-	2.1	7035/ 7024	<b>6071.200</b>	-	-
<b>Support section CP-C</b>								
	Closed	-	-	250	7035	<b>6074.000</b>	<b>6074.000</b>	<b>6074.000</b>
		-	-	500		<b>6074.100</b>	<b>6074.100</b>	<b>6074.100</b>
		-	-	1000		<b>6074.300</b>	<b>6074.300</b>	<b>6074.300</b>
		-	-	2000		<b>6074.500</b>	<b>6074.500</b>	<b>6074.500</b>
	Open	-	-	500	7035/ 7024	<b>6075.100</b>	<b>6075.100</b>	<b>6075.100</b>
		-	-	1000		<b>6075.300</b>	<b>6075.300</b>	<b>6075.300</b>
		-	-	2000		<b>6075.500</b>	<b>6075.500</b>	<b>6075.500</b>
		-	-	2000		<b>6075.500</b>	<b>6075.500</b>	<b>6075.500</b>
<b>Angle piece 90° CP-C</b>								
	-	■	-	1.1	7035/ 7024	<b>6071.400</b>	-	<b>6071.400</b>
<b>Intermediate hinge CP-C</b>								
	■	-	-	4.4	7035/ 7024	-	<b>6071.800</b>	-
<b>Top-mounted joint CP-C</b>								
	Vertical outlet	■	-	3.8	7035	-	-	<b>6072.800</b>
	Horizontal outlet	■	-	4.3	7035/ 7024	-	-	<b>6072.600</b>
<b>Wall-mounted hinge CP-C</b>								
	Vertical outlet	■	-	5.5	7035/ 7024	-	-	<b>6072.400</b>
	Horizontal outlet	■	-	6.1	7035/ 7024	-	-	<b>6072.500</b>
<b>Wall/base mounting bracket, small, CP-C</b>								
	-	■	-	0.5	7035	-	-	<b>6072.200</b>
<b>Wall/base mounting bracket, large, CP-C</b>								
	-	■	-	2.5	7035/ 7024	-	-	<b>6072.000</b>
<b>Mounting component for signal pillar</b>								
	See page 623	-	■	-	7024	<b>6073.000</b>	<b>6073.000</b>	<b>6073.000</b>
<b>Accessories CP-C:</b>								
Adaptor CP-C to CP-L CP 6071.600								see page 143
Connection adaptor CP-L Ø 130 mm to CP-L □ 120 x 65 mm CP 6071.000								see page 142
Support arm, height adjustable								see page 144

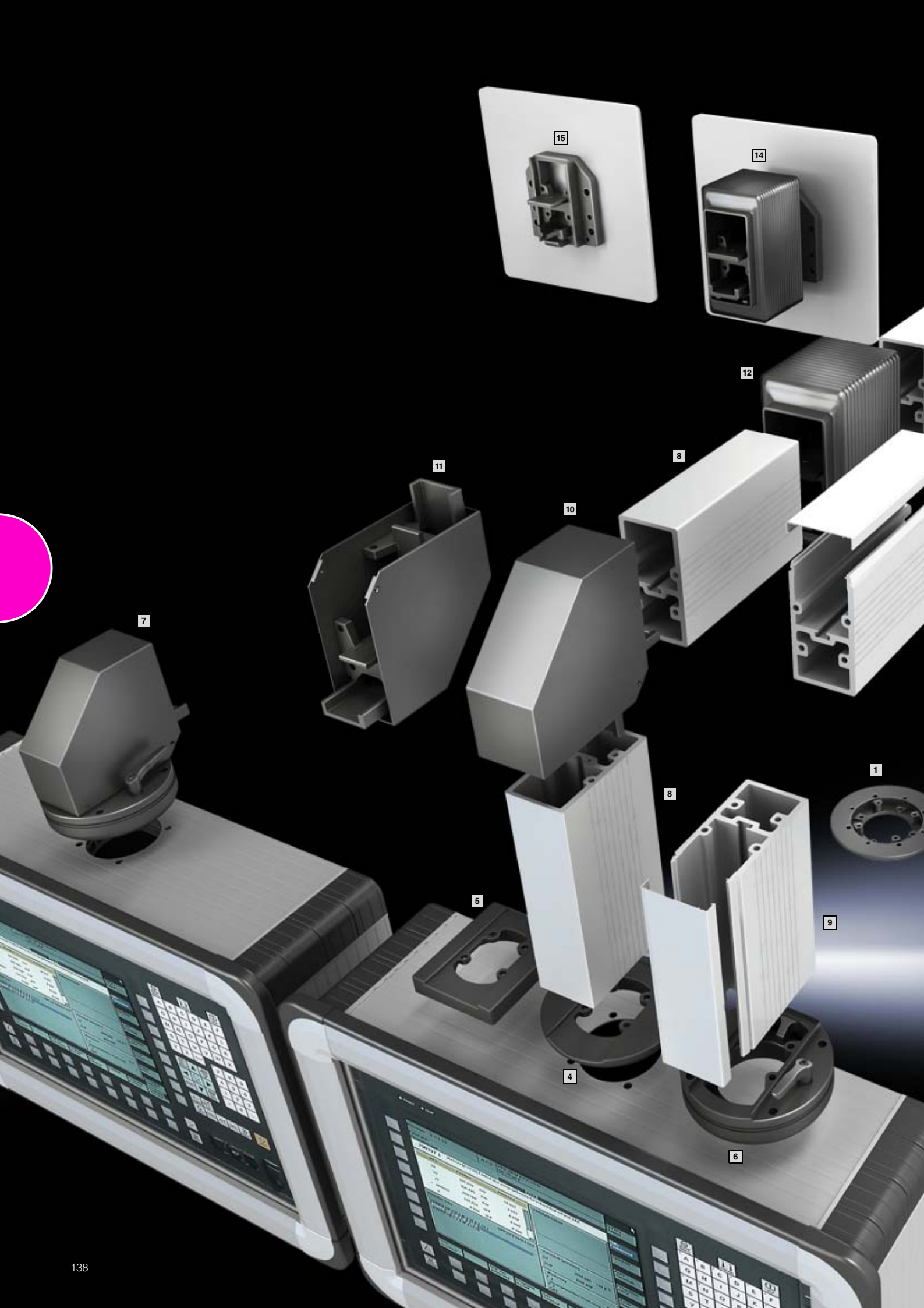

# Support arm system CP-XL

## Overview of components

- 1 Connection adaptor CP-L to CP-XL, 20 mm height (CP 6528.010)
- 2 Connection adaptor CP-L to CP-XL, 55 mm height (CP 6528.510)
- 3 Tilting adaptor 10° CP-XL (CP 6023.010)
- 4 Enclosure attachment, round CP-XL (CP 6130.610)
- 5 Enclosure attachment, square CP-XL (CP 6130.510)
- 6 Housing coupling CP-XL (CP 6130.010)
- 7 Angle coupling 90° CP-XL (CP 6140.010)
- 8 Support section CP-XL, closed (CP 6050.500, 6100.500, 6200.500)
- 9 Support section CP-XL, open (CP 6050.000, 6100.000, 6200.000)
- 10 Angle piece 90° CP-XL, outlet at bottom (CP 6140.010)
- 11 Angle piece 90° CP-XL, outlet at top (CP 6180.010)
- 12 Intermediate hinge CP-XL (CP 6120.010)
- 13 Top-mounted joint CP-XL (CP 6170.010)
- 14 Wall-mounted hinge CP-XL (CP 6110.010)
- 15 Wall/base mounting bracket CP-XL (CP 6160.010)

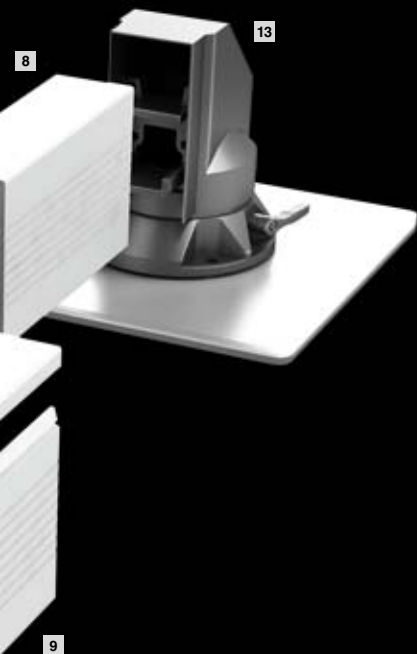

## Load information

Permissible load depending on system configuration

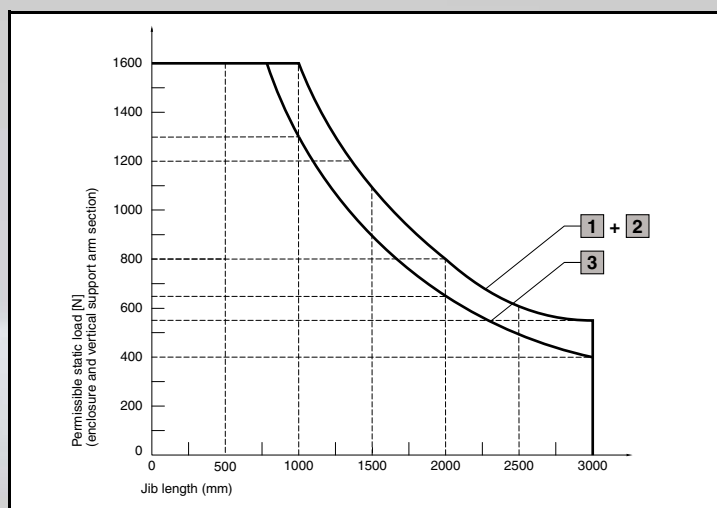

- 1 Open and solid support section without intermediate hinge
- 2 Solid support section with one intermediate hinge
- 3 Open support section with one intermediate hinge

### Note:

Intermediate hinge CP 6120.010 should only be used once per system!

# Support arm system CP-XL



Comfort Panel Page 116 Optipanel Page 118 Compact Panel Page 120 Command panel housing with door Page 121 Operating housings Page 122

## Support section CP-XL

Attachment to the connection components with 4 self-tapping screws in a screw channel, may be cut to any required length. Closed cable duct for higher loads and torsion.

Open cable duct for easy servicing access and for pre-assembled cables with connectors; lockable via clip-in cover.

**Size:**  
External dimensions:  
80 x 155 mm

**Material:**  
Extruded aluminium section

**Colour:**  
RAL 7035

**Supply includes:**  
– Support section CP-XL  
– Clip-in cover  
(only for CP-XL open)

**Detailed drawings:**  
Available on the Internet.

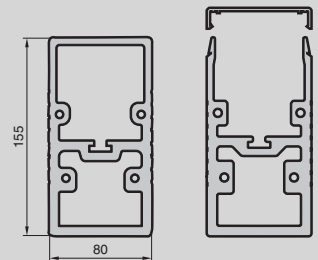

## Cable management

- Open support section for retrospective cable insertion
- Separation of control cables from power supply with two separate ducts

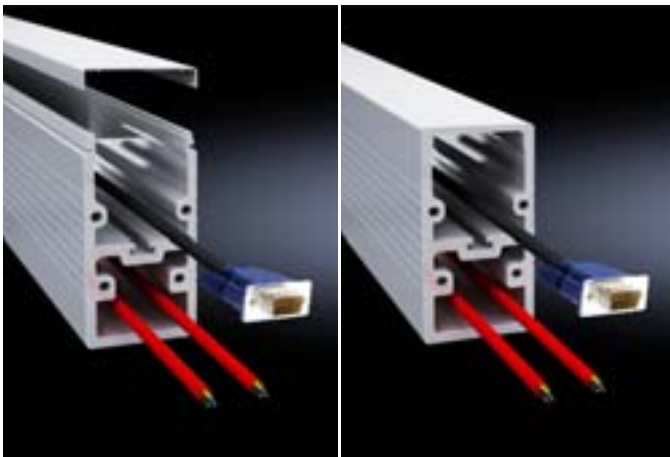

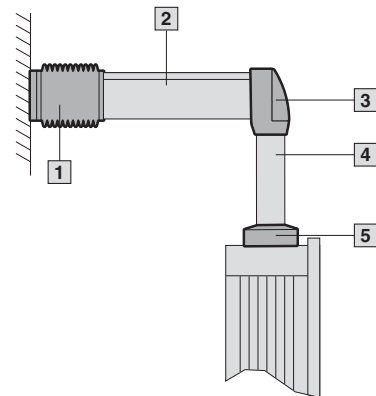

## Combination with support arm systems CP-XL to CP-L

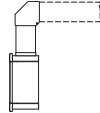

- 1 Wall-mounted hinge CP-XL (CP 6110.010)
- 2 Support section CP-XL (CP 6100.000)
- 3 Angle adaptor 90° CP-XL to CP-L (CP 6528.110)
- 4 Support section CP-L (CP 6511.000)
- 5 Housing coupling CP-L for support arm connection CP-L Ø 130 mm (CP 6525.010)

# Support arm system CP-XL

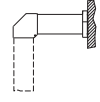
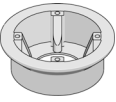
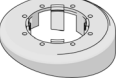
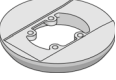
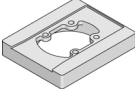
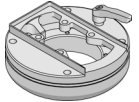
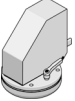
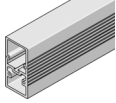
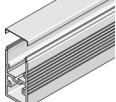
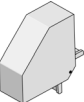
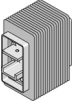
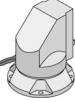
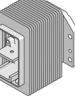
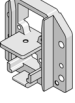
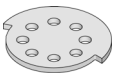
	Rotating/tilting	Rigid	Length mm	Weight kg	Colour RAL	Enclosure section	Desk section	Wall section	
									
						Model No. CP			
<b>Connection adaptor CP-L to CP-XL</b>									
	Height 20 mm	-	■	-	0.6	7024	<b>6528.010</b>	-	-
	Height 55 mm	-	■	-	0.7	7024	<b>6528.510</b>	-	-
<b>Tilting adaptor 10° CP-XL</b>									
		-	■	-	1.4	7024	<b>6023.010</b>	-	-
<b>Enclosure attachment, round CP-XL</b>									
		-	■	-	1.2	7024	<b>6130.610</b>	-	-
<b>Enclosure attachment, rectangular CP-XL</b>									
		-	■	-	1.2	7024	<b>6130.510</b>	-	-
<b>Housing coupling CP-XL</b>									
		■	-	-	3.6	7024	<b>6130.010</b>	-	-
<b>Angle coupling 90° CP-XL</b>									
		■	-	-	2.1	7024	<b>6040.010</b>	-	-
<b>Support section CP-XL</b>									
	Closed	-	-	500	5.5	7035	<b>6050.500</b>	<b>6050.500</b>	<b>6050.500</b>
		-	-	1000	11.0	7035	<b>6100.500</b>	<b>6100.500</b>	<b>6100.500</b>
		-	-	2000	22.0	7035	<b>6200.500</b>	<b>6200.500</b>	<b>6200.500</b>
	Open	-	-	500	4.9	7035	<b>6050.000</b>	<b>6050.000</b>	<b>6050.000</b>
		-	-	1000	9.8	7035	<b>6100.000</b>	<b>6100.000</b>	<b>6100.000</b>
		-	-	2000	19.6	7035	<b>6200.000</b>	<b>6200.000</b>	<b>6200.000</b>
<b>Angle piece 90° CP-XL</b>									
	Outlet at bottom	-	-	-	2.4	7024	<b>6140.010</b>	-	<b>6140.010</b>
	Outlet at top	-	-	-	3.6	7024	<b>6180.010</b>	-	<b>6180.010</b>
<b>Intermediate hinge CP-XL</b>									
		■	-	-	6.5	7024	-	<b>6120.010</b>	-
<b>Top-mounted joint CP-XL</b>									
		■	-	-	11.9	7024	-	-	<b>6170.010</b>
<b>Wall-mounted hinge CP-XL</b>									
		■	-	-	8.5	7024	-	-	<b>6110.010</b>
<b>Wall/base mounting bracket CP-XL</b>									
		-	■	-	4.1	7024	-	-	<b>6160.010</b>
<b>Rotation range restrictor</b>									
	for: Intermediate hinge CP 6120.010 Wall-mounted hinge CP 6110.010	-	■	-	0.6	-	-	<b>6110.100</b>	<b>6110.100</b>

# Support arm systems

## Accessories



### Connection adaptor CP-L Ø 130 mm to CP-L 120 x 65 mm

For external mounting of command panels with support arm cut-out CP-L 120 x 65 mm.

**Material:**

Cast aluminium

**Supply includes:**

Seal and assembly parts.

Height mm	Colour RAL	Weight kg	Model No. CP
40	7035	0.5	6071.000

**Detailed drawings:**

Available on the Internet.



### Connection adaptor CP-L to CP-XL

For mounting between enclosures with support arm connection CP-L and support arm system CP-XL.

May also be used for the attachment of command panels with cut-out for CP-L directly to machines and systems without a support arm. The mounting cut-out CP-XL should be provided there.

**Assembly sequence:**

- Mount the connection adaptor on the supporting structure
- Mount the enclosure and tighten the screws

**Material:**

Cast aluminium

**Supply includes:**

Seal and assembly parts.

Height mm	Colour RAL	Weight kg	Model No. CP
20 <sup>1)</sup>	7024	0.6	6528.010
55	7024	0.7	6528.510

<sup>1)</sup> If the load permits, also suitable for mounting between enclosure with support arm connection CP-XL and support arm system CP-L Ø 130 mm.

**Detailed drawings:**

Available on the Internet.



### Adaptor

**for Siemens Pro-Panel**

- For external mounting of Siemens Simatic Pro-Panel on
  - Support arm system CP-S
  - Support arm system CP-L 120 x 65 mm

**Material:**

Aluminium

**Supply includes:**

Assembly parts.

Colour RAL	Model No. CP
7024	6528.450



### Connection console CP-L

**for Beckhoff Control-Panels**

- Removable cover for easy cable entry with a large opening (110 x 50 mm)
- For external mounting of Beckhoff Control-Panels on
  - Support arm system CP-S
  - Support arm system CP-L 120 x 65 mm

**Material:**

Cast aluminium

**Supply includes:**

Seals and assembly parts for mounting on the enclosure and 2 cable ties.

Colour RAL	Weight kg	Model No. CP
7024	0.7	6508.020

**Detailed drawings:**

Available on the Internet.

# Support arm systems

## Accessories

### Connection plate CP-L

#### With reinforcement plate

- For easy location of the command panel onto the support arm or pedestal.
- More space for cable entry
- For mounting command panels
  - Comfort Panel from a front panel width of 247 mm and installation depth of 152 mm
  - Optipanel from a front panel width of 220 mm and installation depth of 150 mm
  - Sheet steel from 135 mm installation depth

#### Material:

- Connection plate: Cast aluminium
- Reinforcement plate: Sheet steel, 6 mm

#### Supply includes:

Seals and assembly parts.

Colour RAL	Weight kg	Model No. CP
7024	0.7	6528.210

#### Detailed drawings:

Available on the Internet.



### Enclosure attachment, tilting, base mounting

#### CP-L □ 120 x 65 mm

For mounting beneath:

- IW worktop with pedestal
- Adequately large surfaces

Fits enclosures with mounting cut-out:

- CP-L □ 120 x 65 mm (e.g. Optipanel, see page 118, Comfort Panel, see page 116)

With mounting cut-out for connector grommet for sealed cable entry.

#### Tilt angle:

+/-40°, lockable via clamping levers.

#### Material:

Sheet steel

#### Surface finish:

Spray-finished

#### Supply includes:

Assembly parts.

Colour RAL	Weight kg	Model No. IW
7024	1.6	6902.640

#### Note:

The enclosure attachment can be mounted either on the support arm connection of the Optipanel enclosure or on the underside or rear of any enclosure.



#### Accessories:

- Connector gland, see page 522
- IW worktop, see page 111
- Pedestal, see page 147.

#### Detailed drawings:

Available on the Internet.



### Connection adaptor CP-C to CP-L

**Applications:** For integration of the support arm, height-adjustable CP-L (see page 132) to the CP-C support arm system

- For mounting small, flat operating housings if the load capacity of the support arm system CP-C is needed for long jib lengths

#### Benefits:

- Integral adjustment facility

#### Material:

Cast aluminium

#### Supply includes:

- Seals
- Self-tapping screws for CP-L support section attachment.

Weight kg	Model No. CP
0.6	6071.600

#### Detailed drawings:

Available on the Internet.



### Adjustment set for support section CP-XL

The adjustment set also supports retrospective alignment of the CP support section.

#### Material:

Sheet steel 1.0 mm

#### Surface finish:

Zinc-plated

Packs of	Model No. CP
10	6205.000



# Support arm systems

## Accessories



### Housing couplings CP-XL

#### for desktop mounting

The stable, rotating connection with extra space for cable routing.

For additional stability of the roof and base with heavy installed equipment.

For mounting

- Command panels from 150 mm installation depth on
- IW worktops
- Horizontal surfaces (floors or ceilings)

Attachment

- of command panels: With one-man assembly via machined keyholes
- on surfaces: Via external screws with cover

#### Rotation range:

Max. 350°, lockable via clamping levers.

By using additional M6 cheese-head screws, the rotation range may be limited to ±28°, ±73°, ±118°, ±163°.

#### Material:

- Housing coupling: Cast aluminium/die-cast zinc
- Reinforcement plate: Sheet steel, 6 mm

#### Surface finish:

- Housing coupling: Powder-coated, textured
- Reinforcement plate: Zinc-plated

#### Colour:

Housing coupling: RAL 7024

#### Supply includes:

- Reinforcement plate
- Seals
- Assembly parts

Design	Optipanel	Comfort Panel	Weight kg	Model No. CP
W = 418 mm	432 <sup>1)</sup>	435 <sup>1)</sup>	4,2	<b>6528.410</b>

<sup>1)</sup> From front panel width mm without keyboard housing; with keyboard housing on request.

#### Note:

With the Comfort Panel and Optipanel enclosures, the rectangular support arm cut-out can be selected, ordered and prepared using the command panel configurators at [www.rittal.com](http://www.rittal.com).

#### Detailed drawings:

Available on the Internet.



### Support arm, height adjustable for support arm system CP-L

Offers enhanced ergonomics thanks to:

- Adjustment range
  - for tall and short operators
  - for seated and standing work
  - adjustable to a maximum of 800 mm as required via an adjusting screw at the front of the support arm.
- Precise coordination of the compression spring to the enclosure weight via an adjusting screw at the rear of the support arm.
- Complete functional reliability – if the compression spring breaks, the arm will remain in position.
- Clip-off plastic panels for access to integral cable routing.
- Tilting angle of the mounted enclosure is identical in every height position.

#### For 6510.330 and 6510.340:

- More space for cable routing.
- Cables with connectors such as DVI, VGA are also easily inserted.
- Integral locking in three stages.
- Superior load capacity.

#### Supply includes:

Assembly parts.

Overall length mm	Colour RAL	Weight range kg <sup>1)</sup>	Model No. CP
962	9006	10 – 20	<b>6510.210</b>
1090	9006	15 – 32	<b>6510.330</b>
1090	9006	20 – 40	<b>6510.340</b>

<sup>1)</sup> For populated enclosure and vertical support section.

#### Note:

Maximum cross-section for cable entry:  
6510.210 = 8 x 15 mm  
6510.330/.340 = 16 x 40 mm

#### Detailed drawings:

Available on the Internet.



# Support arm systems

## Accessories

### Pivot CP-L

#### with/without jib

- For direct, vertically hinged integration into machines and systems
- Enclosure suspended or top-mounted
- With integral rotation range restrictor
- To fit enclosures with mounting cut-out CP-L Ø 130 mm

Jib length mm	Colour RAL	Load capacity N	Model No. CP
–	7024	700	<b>6016.700</b>
200	7024/7035	700	<b>6016.600</b>

**Detailed drawings:**  
Available on the Internet.



### Support arm bracket 90° CP-L

- For the configuration of compact systems
- To fit support arm system CP-L
- No thread-tapping required

Colour RAL	Weight kg	Model No. CP
7035	3.4	<b>6519.000</b>

**Detailed drawings:**  
Available on the Internet.



### Enclosure attachment, tilting, top mounting

For mounting on:

- IW worktop, prepared for enclosure attachment CP-L, Ø 130 mm, see page 111
- Surfaces
- Enclosure attachment/coupling CP-L □ 120 x 65 mm, see page 133
- Attachment/housing coupling CP-S (may also be used as tilting adaptor +100°/–60° for CP-S), see page 129

To fit enclosures up to 20 kg with support arm connection:

- CP-S
- CP-L □ 120 x 65 mm
- CP-L Ø 130 mm
- VESA Standard 75.

With cable tube for protected cable entry.

#### Tilt angle:

+100°/–60°, adjustable in 7.2° increments via clamping lever and may be limited to +100°/–15° using the stop screw supplied loose.

Colour RAL	Weight kg	Model No. IW
7024	0.8	<b>6902.670</b>

**Material:**  
Sheet steel

**Surface finish:**  
Spray-finished

**Supply includes:**  
– Assembly parts  
– Plastic concertina section

**+** **Accessories:**

IW worktops prepared for enclosure attachment, see page 111.

**Detailed drawings:**  
Available on the Internet.



# Support arm systems

## Accessories



### Angle adaptor 90°

Connection component between:

- small and larger support arm systems.
- Outlet optionally at the top or bottom if this configuration is chosen for static or visual reasons. The removable cover ensures easier cable entry.

**Material:**

Cast aluminium

**Supply includes:**

Seal for support section attachment.

	Colour RAL	Weight kg	Model No. CP
CP-L to CP-S	7024	1.0	6501.090
CP-XL to CP-L	7024	1.7	6528.110

**Detailed drawings:**

Available on the Internet.





Comfort Panel Page 116 Optipanel Page 118 Compact Panel Page 120 Command panel housing with door Page 121 Operating housings Page 122

Pedestal, modular, consisting of:

- Pedestal base plate
- Support section
- Enclosure connection

**Colour:**  
RAL 7035

**Detailed drawings:**

Available on the Internet.

Photo shows a configuration example with equipment not included in the scope of supply.

## Pedestal, modular

Weight load kg	15	18	35	50	Page
<b>1 Pedestal base plate</b>	<b>Model No. CP</b>				
Pedestal base plate	<b>6146.100</b>	<b>6143.200</b>	<b>6137.535</b>	<b>6137.035</b>	
Dimensions W x H x D mm	400 x 10 x 400	400 x 108 x 400	490 x 100 x 600		
<b>2 Support section</b>	<b>Model No. CP</b>				
Height-adjustable (adjustment range 732 – 1122 mm)	<b>6146.200</b>	–	–	–	
Closed, length 1000 mm	–	6513.000	6513.000	6100.500	133/141
Open, length 1000 mm	–	6513.050	6513.050	6100.000	133/141
<b>3 Enclosure connection</b>	<b>Model No. CP</b>				
Enclosure reinforcement, rigid	–	6143.210	–	–	151
Enclosure attachment CP-S	6501.070	–	–	–	129
Housing coupling CP-S	6501.050	–	–	–	129
Enclosure attachment CP-L, Ø 130 mm	–	–	6525.510	–	133
Enclosure attachment CP-L, □ 120 x 65 mm	–	–	6525.610	–	133
Housing coupling CP-L, Ø 130 mm	–	–	6525.010	–	133
Housing coupling CP-L, □ 120 x 65 mm	–	–	6525.110	–	133
Enclosure attachment CP-XL, round	–	–	–	6130.610	141
Enclosure attachment CP-XL, rectangular	–	–	–	6130.510	141
Housing coupling CP-XL	–	–	–	6130.010	141
Tilt adjustment	<b>6146.300</b>	–	–	–	
<b>Accessories</b>					
Twin castors	6148.000	–	6148.000	6148.000	374
Levelling feet	–	–	4612.000	4612.000	373
Base mount	–	–	1590.000	1590.000	439
Gas pressurised spring, load capacity 15 kg	<b>6146.400</b>	–	–	–	

# Stand systems



Comfort Panel Page 116 Optipanel Page 118 Compact Panel Page 120 Command panel housing with door Page 121 Operating housings Page 122

The right system to suit any application:

- Fixed or mobile variant
- Different designs
- Weight load from 15 – 50 kg
- Reliable protection of cable management

**Colour:**  
RAL 7035

**Detailed drawings:**  
Available on the Internet.

Photo shows a configuration example with equipment not included in the scope of supply.

## Pedestal, complete

Weight load kg	25	25	35	50	50	Page
<b>Model No. CP</b>	<b>6141.100</b>	<b>6141.200</b>	<b>6136.500</b>	<b>6136.000</b>	<b>6135.000</b>	
Dimensions W x H x D mm	600 x 1093 x 660	600 x 946 x 660	600 x 1005 x 550		360 x 995 x 500	
<b>Supply includes</b>						
Cross member	■	■	■	■	–	
Base plate	–	–	–	–	■	
Twin castors	–	–	■	■	–	
Support section	■	–	■	■	■	
Vertical aluminium moulding, may be opened	■	■	–	–	–	
Worktop attachment	–	■	–	–	–	
<b>Accessories</b>						
Twin castors	6148.000, 7495.000	6148.000, 7495.000	–	–	–	374
Levelling feet	4612.000	4612.000	–	–	–	373
Base mount	6147.000	6147.000	–	–	–	151
Trim panel for pedestal	6144.100	6144.100	–	–	–	151
Enclosure attachment CP-L, Ø 130 mm	6525.510	–	6525.510	–	–	133
Enclosure attachment CP-L, □ 120 x 65 mm	6525.610	–	6525.610	–	–	133
Housing coupling CP-L, Ø 130 mm	6525.010	–	–	–	–	133
Housing coupling CP-L, □ 120 x 65 mm	6525.110	–	–	–	–	133
Enclosure attachment CP-L, □ 120 x 65 mm, locatable	6525.210	–	–	–	–	133
Enclosure attachment CP-XL, round	–	–	–	6130.610	–	141
Enclosure attachment CP-XL, rectangular	–	–	–	6130.510	–	141
Enclosure attachment, tilting	–	6902.640	–	–	–	143
Worktop without handle <sup>1)</sup>	–	<b>6902.310</b>	–	–	–	

■ Included with the supply.

<sup>1)</sup> W x H x D 950 x 38 x 600 mm



Comfort Panel Page 116 Optipanel Page 118 Compact Panel Page 120 Command panel housing with door Page 121 Operating housings Page 122

- The welded alternatives to the pedestal, complete
- Pedestal, open:  
For retrospective cable entry with pre-assembled connectors
  - Pillar, small:  
For heavy installed equipment

**Material:**  
Steel

**Surface finish:**  
Spray-finished

**Colour:**  
RAL 7035

**Detailed drawings:**  
Available on the Internet.

Photo shows a configuration example with equipment not included in the scope of supply.

## Pillar, small

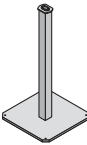
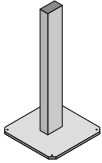
			
Weight load kg	40	80	Page
<b>Model No. CP</b>	<b>6215.000</b>	<b>6214.500</b>	
<b>Design</b>			
Base plate cross-section W x H x D mm	400 x 10 x 400	500 x 12 x 500	
Pedestal tube cross-section W x H mm	86 x 73	160 x 80	
Pedestal tube wall thickness mm	3	3,2	
Overall height mm	1093	1150	
<b>Accessories</b>			
Enclosure attachment CP-L, Ø 130 mm	6525.510	–	133
Housing coupling CP-L, Ø 130 mm	6525.010 <sup>1)</sup>	–	133
Enclosure attachment CP-XL, round	–	6130.610	141
Enclosure attachment CP-XL, rectangular	–	6130.510	141
Housing coupling CP-XL	–	6130.010	141

<sup>1)</sup> When assembling enclosures with support arm connection CP-L, □ 120 x 65 mm, connection adaptor CP-L, Ø 130 mm to CP-L, □ 120 x 65 mm CP 6071.000 (see page 142) should additionally be used.

# Stand systems



**Support arm system CP-S** Page 127 **Support arm system CP-L** Page 131 **Support arm system CP-C** Page 135 **Support arm system CP-XL** Page 139

The stable base point for the support arm system. The attachment of additional enclosures, e.g. for security systems, is also possible. There is a choice of 2 cross-sections:

- 140 x 140 mm
- 200 x 200 mm

#### Design:

- Base plate, thickness: 15 mm, with 4 mounting holes
- Cut-out in the base plate in accordance with the cross-section for cable entry from below
- Pedestal tube (wall thickness 5 mm) welded to the base plate
- Connection facility for support arm systems as per the selection table.

#### Delivery time:

Available on request.

#### Material:

Steel

#### Surface finish:

Spray-finished

#### Colour:

RAL 7035

#### Supply includes:

Assembly parts for support arm system according to selection.

#### Note:

Customer-specific designs, such as:

- Other RAL colours
- Heights
- Consoles for additional enclosures available on request.



#### Accessories:

- Support arm system CP-S, see page 128
- CP-L, see page 132
- CP-C, see page 136
- CP-XL, see page 140
- Gland plates size 2, see from page 514.

#### Detailed drawings:

Available on the Internet.

Photo shows a configuration example with equipment not included in the scope of supply.

## Pillar

Design	For support arm system	Model No. CP
Cross-section 140 x 140 mm, height 2000 mm <sup>1)</sup>	CP-S, CP-L, CP-C	<b>6214.000</b>
Cross-section 200 x 200 mm, height 2000 mm <sup>1)</sup>	CP-C, CP-XL	<b>6220.000</b>

<sup>1)</sup> Unless otherwise specified.

#### In addition to the Model Number, the following information is also needed:

1. Unless otherwise stated, the position for the cable entry cut-out is on the rear.
2. Position and Item No. of support arm component

Support arm component	Support arm system			
	CP-S	CP-L	CP-C	CP-XL
Wall/base mounting bracket, large, side mounting	6501.110	6520.010	6072.000	6160.010
Wall-mounted hinge, horizontal outlet, side mounting	6501.150	6521.010	6072.500	6110.010
Top-mounted joint, mounting on top	6501.160	6522.010	6072.600, 6072.800	6170.010

### Base mount

Brackets for screw-fastening from below to the cast feet with posidrive raised countersunk screws M12. Optionally with projection at the front, interior or sides, with Ø 11 mm hole for screw-fastening to the base.

**Material:**  
Steel

**Surface finish:**  
Zinc-plated

**Supply includes:**  
Posidrive raised countersunk screws M12.

Packs of	<b>Model No. CP</b>
4	<b>6147.000</b>



### Trim panel

**Material:**  
Cast aluminium

**Supply includes:**  
Assembly parts for screw-fastening between the cast feet at the front or rear.

Colour RAL	<b>Model No. CP</b>
7035 textured	<b>6144.100</b>



### Enclosure reinforcement

For external or internal reinforcement of enclosures of a corresponding size. Smaller enclosures may also be mounted directly without enclosure reinforcement.

**Supply includes:**  
Assembly parts for the enclosure and support section plus 2 seals.

**Detailed drawings:**  
Available on the Internet.

	For enclosure	Support arm connection	Material	Weight kg	Model No. CP
<b>1</b>	B1 ≥ 300 mm, T1 ≥ 150 mm	CP-S	Stainless steel 1.4301	0.9	<b>6143.310</b>
<b>2</b>	B1 ≥ 300 mm, T1 ≥ 150 mm	CP-L	Sheet steel	0.9	<b>6143.210</b>
<b>3</b>	CP 6662.500 or AE (B1 = 600 mm, T1 ≥ 210 mm)	CP-XL	Sheet steel	2.2	<b>6503.000</b>

B = Width  
T = Depth







# Hygienic Design

---

## Small and compact enclosures HD

Terminal boxes HD .....	154
Compact enclosures HD, single-door .....	155
Accessories .....	156

# Hygienic Design

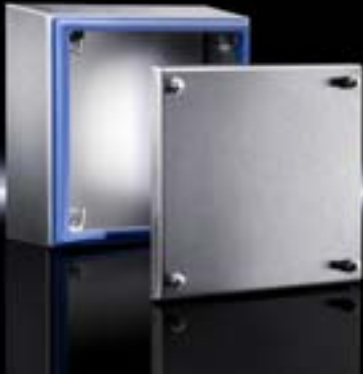

HD accessories Page 156 System accessories Page 355

### Material:

- Enclosure and cover: Stainless steel 1.4301 (AISI 304), 1.5 mm
- Mounting bracket: Sheet steel, zinc-plated, passivated, 2.0 mm
- Quick-release fasteners: Stainless steel
- Seal: Silicone, compliant with FDA Guideline 21 CFR 177.2600

### Surface finish:

- Enclosure and cover: Brushed, grain 400,  $R_A < 0.8 \mu\text{m}$
- Seal: Blue, dyed (RAL 5010)

### Protection category:

- IP 66 to IEC 60 529
- IP 69K to DIN 40 050-9
- Compliant with NEMA 13
- Compliant with NEMA 4X
- Compliant with NEMA 3R

### Supply includes:

- Enclosure of all-round solid construction
- Cover
- Mounting bracket (pre-assembled)
- Seal and quick-release locks (supplied loose)

### Detailed drawing:

Available on the Internet.

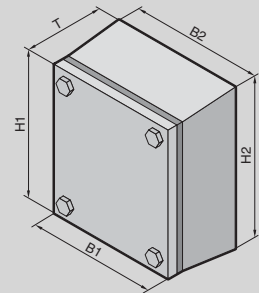

## Terminal boxes HD

Width	Front (B1) mm	Rear (B2) mm	Packs of	150	172	177	200	227	227	227	300	400	400	400	Page
<b>Height</b>	Front (H1) mm	Rear (H2) mm		150	172	177	200	227	227	227	200	200	200	300	
	Depth (T) mm			80	120	120	120	120	120	120	120	120	120	120	
<b>Model No. HD</b>			1	<b>1670.600</b>	<b>1671.600</b>	<b>1671.600</b>	<b>1672.600</b>	<b>1672.600</b>	<b>1672.600</b>	<b>1672.600</b>	<b>1674.600</b>	<b>1675.600</b>	<b>1675.600</b>	<b>1676.600</b>	
<b>Accessories</b>															
Wall spacer bracket HD			1	4000.100	4000.100	4000.100	4000.100	4000.100	4000.100	4000.100	4000.100	4000.100	4000.100	4000.100	156
Mounting plate			1	1560.700	1560.700	1560.700	1562.700	1562.700	1563.700	1563.700	1563.700	1564.700	1564.700	1568.700	443
Support rail TS 35/7.5			10	2314.000	2314.000	2314.000	2315.000	2315.000	2316.000	2316.000	2317.000	2317.000	2317.000	2317.000	467
Cable gland HD				see page 521											



## Rittal Austria

RITTAL Schaltschränke Gesellschaft m.b.H.  
Laxenburger Straße 246a · A-1239 Wien  
Phone: +43 (0) 5 99 40-0  
Fax: +43 (0) 5 99 40-99 0  
E-mail: info@rittal.at · www.rittal.at

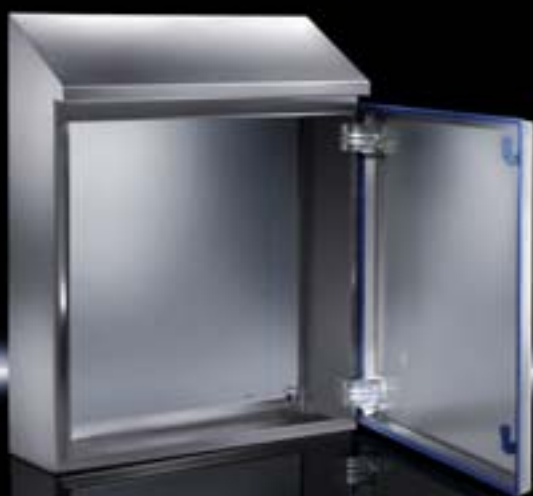

HD accessories Page 156 System accessories Page 355

### Material:

- Enclosure and door: Stainless steel 1.4301 (AISI 304)
- Mounting plate: Sheet steel
- Lock inserts HD: Stainless steel 1.4404 (AISI 316L)
- Seal: Silicone, compliant with FDA Guideline 21 CFR 177.2600

### Surface finish:

- Enclosure and door: Brushed, grain 400,  $R_A < 0.8 \mu\text{m}$
- Mounting plate: Zinc-plated
- Seal: Blue, dyed (RAL 5010)

### Protection category:

- IP 66 to IEC 60 529
- IP 69K to DIN 40 050-9
- Compliant with NEMA 13
- Compliant with NEMA 4X

### Supply includes:

- Enclosure of all-round solid construction
- Door with press-fitted seal
- Interchangeable door hinge
- Mounting plate

### Detailed drawing:

Available on the Internet.

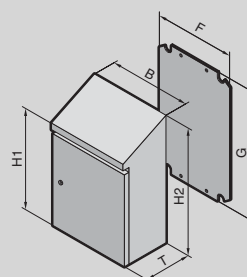
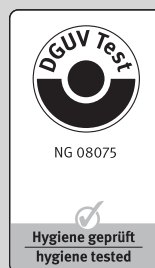

## Compact enclosures HD, single-door

Width	(B) mm	Packs of	220	390	390	510	610	610	810	810	Page
Height	Front (H1) mm		350	430	650	550	430	650	1050	1250	
	Rear (H2) mm		437	549	769	669	601	769	1221	1421	
Depth	(T) mm		155	210	210	210	300	210	300	300	
Mounting plate width (F) mm			162	334	334	449	549	549	739	740	
Mounting plate height (G) mm			275	355	570	470	355	570	955	1155	
<b>Model No. HD</b>		1	<b>1302.600</b>	<b>1306.600</b>	<b>1308.600</b>	<b>1307.600</b>	<b>1320.600</b>	<b>1310.600</b>	<b>1316.600</b>	<b>1317.600</b>	
<b>Accessories</b>											
Wall spacer bracket HD		1	4000.100	4000.100	4000.100	4000.100	4000.100	4000.100	4000.100	4000.100	156
Rails for interior installation											see page 157
Cable gland HD											see page 521



## Rittal Czech Republic

RITTAL Czech, s.r.o.  
 Ke Zdibsku 182 · 250 66 Zdiby u Prahy  
 Phone: +420 234 099 000  
 Fax: +420 234 099 099  
 E-mail: info@rittal.cz · www.rittal.cz

# Hygienic Design

## Accessories



### Levelling feet HD

for TS 8

**Benefits:**

- Minimises cleaning time thanks to fully covered, permanently sealed threads.
- Compensation of floor inclines up to an angle of 10° thanks to flexible base plate.
- Baying can even be achieved on sloping floors, thanks to a large levelling range of 55 mm.

**Load capacity:**

Max. 5000 N static per levelling foot.

**Material:**

Stainless steel 1.4301 (AISI 304)

**Supply includes:**

Assembly parts and seals.

Thread	Levelling range mm	Base mount	Packs of	Model No. HD
M12	120 – 175	without	4	<b>4000.200</b>
		with	4	<b>4000.210</b>



### Wall spacer bracket HD

**Benefits:**

- Creates space for cleaning behind the enclosure.
- Shorter assembly times by eliminating the need for an all-round seal.
- Greater hygiene safety by avoiding an uncontrollable dead space or gap between the enclosure and wall.

**Functional principle:**

- Mounting on the wall optionally from the enclosure interior via a through-hole (max. M8) or from the rear via an integral M10 thread.

**Material:**

Stainless steel 1.4301 (AISI 304)

**Supply includes:**

Assembly parts and seals.

Wall distance mm	Packs of	Model No. HD
50	1	<b>4000.100</b>



### Enclosure key HD

Packs of	Model No. HD
1	<b>2549.600</b>



### Bit HD

for universal key SZ 2549.500

See page 424.

Packs of	Model No. HD
1	<b>2549.510</b>



### Cam lock HD

Hygienic Design variant for easy, safe cleaning.

**Applications:**

- Compact enclosures AE stainless steel (except AE 1017.XXX and AE 1019.XXX).
- May be integrated into customised applications, e.g. covers of machine panels.

**Material:**

Stainless steel 1.4404 (AISI 316L)

Packs of	Model No. HD
1	<b>2304.010</b>

**+** **Accessories:**

Enclosure key HD, see page 156.

### Rails for interior installation

#### for compact enclosures HD

For mounting on the existing threaded bolts.  
With TS system punchings on three sides.

#### Material:

Sheet steel, zinc-plated

#### Supply includes:

Assembly parts.

Length mm	Packs of	Model No. CM	Page
510	4	5001.050	459
710	4	5001.051	459
910	4	5001.052	459
1110	4	5001.053	459

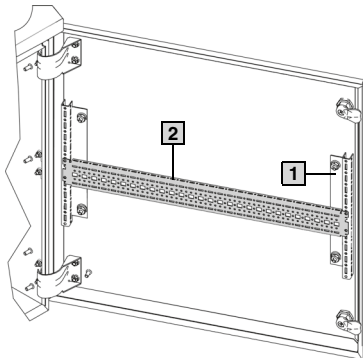
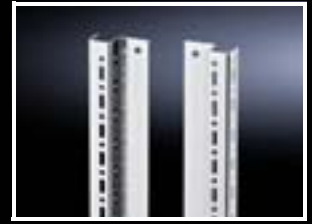

#### Interior installation, door

Enclosure	1		
Model No. HD	Model No. CM		
1316.600	5001.052	5001.050	5001.050
1317.600	5001.053	5001.051 5001.050	5001.051 5001.050

#### Rails for door installation

Enclosure	2
	TS punched section without mounting flange, 17 x 73 mm 
Model No. HD	Model No. TS
1316.600 1317.600	8612.065

#### Interior installation, enclosure

Enclosure	1	3	4
	Rails for interior installation 	TS punched section without mounting flange, 17 x 73 mm 	Mounting plates 
Model No. HD	Model No. CM	Model No. TS	
1308.600 1310.600	5001.050	-	-
1316.600	5001.052	8612.130 (only on lock side)	8612.400 8612.410
1317.600	5001.053	8612.130 (only on lock side)	8612.400 8612.410

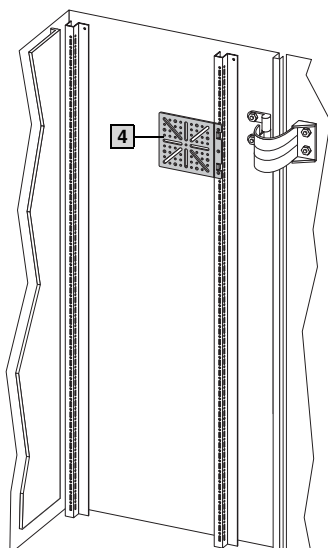
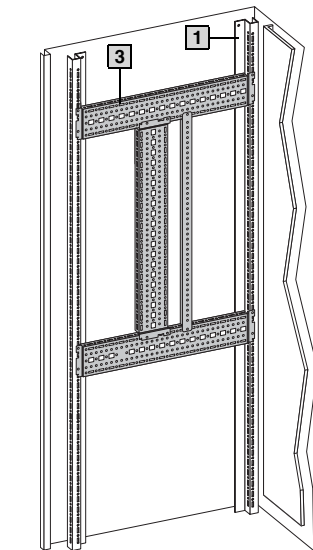



# Stainless steel

---

## Small enclosures

Switch housings .....	160
Terminal boxes KL.....	161
Bus enclosures BG.....	161

## Compact enclosures

Compact enclosures AE.....	162
Compact enclosures AE, protection category IP 69K.....	165

## Operating housings

Premium Panel, protection category IP 69K .....	166
Command panel housing with door .....	167

## Support arm system

Support section CP-S, stainless steel .....	168
Support arm system CP-S, stainless steel, components .....	169

## Enclosure systems

One-piece consoles AP.....	170
PC enclosure systems .....	171
Baying systems TS 8 .....	172

# Stainless steel



**System accessories** Page 355

**Material:**

- Enclosure: Stainless steel 1.4301 (AISI 304), 1.25 mm
- Cover: Stainless steel 1.4301 (AISI 304), 1.25 mm, all-round foamed-in PU seal

**Surface finish:**

- Enclosure and cover: Brushed, grain 240 or 180 (for terminal boxes)

**Protection category:**

IP 66 to IEC 60 529, complies with NEMA 4X.

**Supply includes:**

- Enclosure with cover
- Product-specific supply scope, see tables

**Approvals:**

**Terminal boxes KL**

- UL
- CSA
- TÜV
- Germanischer Lloyd
- Russian Maritime Register of Shipping
- Lloyds Register of Shipping
- Bureau Veritas
- VDE

**Bus enclosures BG**

- TÜV
- Lloyds Register of Shipping
- VDE
- UL
- cUL

**Detailed drawings:**

Available on the Internet.

Photo shows a configuration example with equipment not included in the scope of supply.

## Switch housings

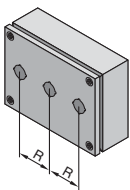

	Width mm	Packs of	100	160	220	280	Page
<b>Height mm</b>			100	100	100	100	
<b>Depth mm</b>			90	90	90	90	
<b>Model No. SM</b>		1	<b>2384.010</b>	<b>2384.020</b>	<b>2384.030</b>	<b>2384.040</b>	
Pitch pattern (R) mm			-	60	60	60	
No. of switch cut-outs, Ø 22.5 mm			1	2	3	4	
Number of quick-release fasteners			2	4	4	4	
<b>Accessories</b>							
Wall mounting bracket		4	1594.000	1594.000	1594.000	1594.000	439
Pressure relief stoppers		5	2459.500	2459.500	2459.500	2459.500	384
Cable gland HD			see page 521				



## Rittal Switzerland

RITTAL AG  
 Ringstrasse 1 · CH-5432 Neuenhof  
 Phone: +41 (0) 56 416 06 00  
 Fax: +41 (0) 56 416 06 66  
 E-mail: rittal@rittal.ch · www.rittal.ch



## Terminal boxes KL

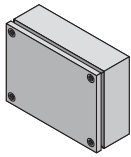

Width mm	Packs of	150	150	300	200	200	Page
Height mm		150	150	150	200	200	
Depth mm		80	120	80	80	120	
<b>Model No. KL</b>	1	<b>1521.010</b>	<b>1527.010</b>	<b>1522.010</b>	<b>1523.010</b>	<b>1528.010</b>	
Weight (kg)		1.3	1.6	1.8	1.8	2.2	
Number of quick-release fasteners		4	4	4	4	4	

### Accessories

Mounting plate	1	1560.700	1560.700	1561.700	1562.700	1562.700	443
Wall mounting bracket	4	1594.000	1594.000	1594.000	1594.000	1594.000	439
Wall angle	4	2583.010	2583.010	2583.010	2583.010	2583.010	440
Pole clamp	1	2584.000	2584.000	2584.000	2584.000	2584.000	441
Support rails TS 35/7.5	10	2314.000	2314.000	2316.000	2315.000	2315.000	467
Cover hinge, stainless steel 1.4404	2	1592.010	1592.010	1592.010	1592.010	1592.010	425
Pressure relief stoppers	5	2459.500	2459.500	2459.500	2459.500	2459.500	384

Width mm	Packs of	300	300	400	300	400	Page
Height mm		200	200	200	300	300	
Depth mm		80	120	120	120	120	
<b>Model No. KL</b>	1	<b>1524.010</b>	<b>1529.010</b>	<b>1525.010</b>	<b>1526.010</b>	<b>1530.010</b>	
Weight (kg)		2.4	2.9	3.6	3.9	4.6	
Number of quick-release fasteners		4	4	4	4	4	

### Accessories

Mounting plate	1	1563.700	1563.700	1564.700	1567.700	1568.700	443
Wall mounting bracket	4	1594.000	1594.000	1594.000	1594.000	1594.000	439
Wall angle	4	2583.010	2583.010	2583.010	2583.010	2583.010	440
Pole clamp	1	2584.000	2584.000	2584.000	2584.000	2584.000	441
Support rails TS 35/7.5	10	2316.000	2316.000	2317.000	2316.000	2316.000	467
Cover hinge, stainless steel 1.4404	2	1592.010	1592.010	1592.010	1592.010	1592.010	425
Pressure relief stoppers	5	2459.500	2459.500	2459.500	2459.500	2459.500	384

## Bus enclosures BG

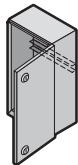

Width mm	Packs of	200	300	400	Page
Height mm		300	300	300	
Depth mm		80	80	80	
<b>Model No. BG</b>	1	<b>1583.010<sup>1)</sup></b>	<b>1584.010<sup>1)</sup></b>	<b>1585.010<sup>1)</sup></b>	
Weight (kg)		2.8	3.7	4.5	
Number of quick-release fasteners		2	2	2	

### Product-specific supply scope

Support rail TS 35/7.5	1	■	■	■	467
180° hinge, die-cast zinc, chrome-plated	2	■	■	■	425

### Accessories

Wall mounting bracket	4	1594.000	1594.000	1594.000	439
Pole clamp	1	2584.000	2584.000	2584.000	441
Condensate discharge	6	2459.000	2459.000	2459.000	384

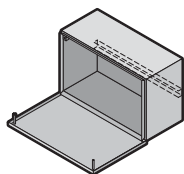

Width mm	Packs of	400	600	Page
Height mm		200	200	
Depth mm		123	123	
<b>Model No. BG</b>	1	<b>1558.010<sup>2)</sup></b>	<b>1559.010<sup>2)</sup></b>	
Weight (kg)		4.5	6.0	
Number of quick-release fasteners		2	3	

### Product-specific supply scope

Support rail TS 35/7.5	1	■	■	467
180° hinge, die-cast zinc, chrome-plated	2	■	■	425

### Accessories

Wall mounting bracket	4	1594.000	1594.000	439
Pole clamp	1	2584.000	2584.000	441
Condensate discharge	6	2459.000	2459.000	384

<sup>1)</sup> Support rail fixed on studs

<sup>2)</sup> Support rail adjustable on profile strip

# Stainless steel



System accessories Page 355 Compact enclosures AE, sheet steel Page 44 Hygienic Design Page 154

## Material:

- Enclosure: Stainless steel
- Door: Stainless steel, all-round foamed-in PU seal
- Mounting plate: Sheet steel
- Locks: Die-cast zinc

## Surface finish:

- Enclosure and door: Brushed, grain 240
- Mounting plate: Zinc-plated
- Locks: Nickel-plated

## Protection category:

See tables.

## Supply includes:

- Enclosure with door(s)
- Cam lock or 3-point lock system (for AE 1017.X00 and AE 1019.X00) with double-bit insert
- Mounting plate

## Approvals:

- UL
- CSA
- TÜV
- Germanischer Lloyd
- Russian Maritime Register of Shipping
- Lloyds Register of Shipping
- Bureau Veritas
- VDE

## Detailed drawing:

Available on the Internet.

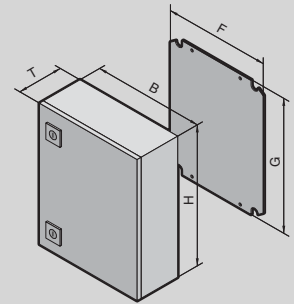

## Compact enclosures AE

Width (B) mm	Packs of	200	200	200	300	380	380	Page	
Height (H) mm		300	300	300	300	300	300		
Depth (T) mm		120	155	155	210	155	210		
Mounting plate width (F) mm		162	162	162	254	334	334		
Mounting plate height (G) mm		275	275	275	275	275	275		
<b>Model No. AE</b>		<b>1001.600</b>	<b>1002.600</b>	<b>1002.500</b>	<b>1003.600</b>	<b>1004.600</b>	<b>1011.600</b>		
Material	1.4301 (AISI 304)	1	■	■	–	■	■		
	1.4404 (AISI 316L)	1	–	–	■	–	–		
Door		1	1	1	1	1	1		
Weight (kg)		3.6	4.1	4.1	6.9	7.4	8.4		
<b>Protection category</b>		IP 66 to IEC 60 529, complies with NEMA 4X							
<b>Accessories</b>									
Rails for interior installation		4	–	–	–	2373.210	–	2373.210	459
Rain canopy	1.4301 (AISI 304)	1	–	2470.000	2470.000	2361.000	2471.000	2472.000	431
	1.4301 (AISI 304)	4	2433.000	2433.000	–	2433.000	2433.000	2433.000	439
Wall mounting bracket	1.4404 (AISI 316L)	4	–	–	2433.500	–	–	–	439
Wall angle	1.4301 (AISI 304)	4	2583.010	2583.010	2583.010	2583.010	2583.010	2583.010	440
Pole clamp		1	2584.000	2584.000	2584.000	2584.000	2584.000	2584.000	441
Cam lock 1.4404 (AISI 316L)	Standard	1	2304.000	2304.000	2304.000	2304.000	2304.000	2304.000	421
	Hygienic Design	1	2304.010	2304.010	2304.010	2304.010	2304.010	2304.010	156
Alternative lock systems			see page 414						

## Compact enclosures AE

Width (B) mm	Packs of	300	300	380	380	600	400	Page
Height (H) mm		380	380	380	380	380	500	
Depth (T) mm		210	210	210	210	210	210	
Mounting plate width (F) mm		275	275	334	334	549	354	
Mounting plate height (G) mm		334	334	355	355	355	475	
<b>Model No. AE</b>	<b>1</b>	<b>1005.600</b>	<b>1005.500</b>	<b>1006.600</b>	<b>1006.500</b>	<b>1009.600</b>	<b>1015.600</b>	
Material	1.4301 (AISI 304)	■	–	■	–	■	■	
	1.4404 (AISI 316L)	–	■	–	■	–	–	
Door		1	1	1	1	1	1	
Weight (kg)		8.4	8.4	9.8	9.8	14.6	12.9	
<b>Protection category</b>	IP 66 to IEC 60 529, complies with NEMA 4X							

<b>Accessories</b>								
Rails for interior installation		4	2373.210	2373.210	2373.210	2373.210	2373.210	459
Rain canopy	1.4301 (AISI 304)	1	2361.000	2361.000	2472.000	2472.000	2473.000	431
Wall mounting bracket	1.4301 (AISI 304)	4	2433.000	–	2433.000	–	2433.000	439
	1.4404 (AISI 316L)	4	–	2433.500	–	2433.500	–	439
Wall angle	1.4301 (AISI 304)	4	2583.010	2583.010	2583.010	2583.010	2583.010	440
Pole clamp		1	2584.000	2584.000	2584.000	2584.000	2584.000	441
Cam lock 1.4404 (AISI 316L)	Standard	1	2304.000	2304.000	2304.000	2304.000	2304.000	421
	Hygienic Design	1	2304.010	2304.010	2304.010	2304.010	2304.010	156
Alternative lock systems	see page 414							

Width (B) mm	Packs of	500	500	380	600	600	600	Page
Height (H) mm		500	500	600	600	600	760	
Depth (T) mm		210	300	210	210	210	210	
Mounting plate width (F) mm		449	449	334	549	549	549	
Mounting plate height (G) mm		470	470	570	570	570	730	
<b>Model No. AE</b>	<b>1</b>	<b>1007.600</b>	<b>1013.600</b>	<b>1008.600</b>	<b>1010.600</b>	<b>1010.500</b>	<b>1012.600</b>	
Material	1.4301 (AISI 304)	■	■	■	■	–	■	
	1.4404 (AISI 316L)	–	–	–	–	■	–	
Door		1	1	1	1	1	1	
Weight (kg)		15.7	18.4	15.1	23.5	23.5	30.2	
<b>Protection category</b>	IP 66 to IEC 60 529, complies with NEMA 4X							

<b>Accessories</b>								
Rails for interior installation		4	2373.210	2373.300	2373.210	2373.210	2373.210	459
Rain canopy	1.4301 (AISI 304)	1	2362.000	–	2472.000	2473.000	2473.000	431
Wall mounting bracket	1.4301 (AISI 304)	4	2433.000	2433.000	2433.000	2473.000	–	439
	1.4404 (AISI 316L)	4	–	–	–	–	2433.500	439
Wall angle	1.4301 (AISI 304)	4	2583.010	2583.010	2583.010	2583.010	2583.010	440
Pole clamp		1	2584.000	2584.000	2584.000	2584.000	2584.000	441
Cam lock 1.4404 (AISI 316L)	Standard	1	2304.000	2304.000	2304.000	2304.000	2304.000	421
	Hygienic Design	1	2304.010	2304.010	2304.010	2304.010	2304.010	156
Alternative lock systems	see page 414							



## Rittal Hungary

RITTAL Kereskedelmi Kft.  
 1044 Budapest, Ipari Park u. 1.  
 Phone: +36 (1) 399 8000  
 Fax: +36 (1) 399 8009  
 E-mail: rittal@rittal.hu · www.rittal.hu

# Stainless steel

## Compact enclosures AE

Width (B) mm	Packs of	760	800	800	1000	1000	1000	Page	
Height (H) mm		760	1000	1200	1000	1200	1200		
Depth (T) mm		300	300	300	300	300	300		
Mounting plate width (F) mm		704	739	740	939	940	940		
Mounting plate height (G) mm		730	955	1155	955	1155	1155		
<b>Model No. AE</b>	1	<b>1014.600</b>	<b>1016.600</b>	<b>1017.600</b>	<b>1018.600</b>	<b>1019.600</b>	<b>1019.500</b>		
Material	1.4301 (AISI 304)	■	■	■	■	■	–		
	1.4404 (AISI 316L)	–	–	–	–	–	■		
3-point lock system		–	–	■	–	■	■		
Door(s)		1	1	1	2	2	2		
Weight (kg)		42.5	52.9	61.5	71.0	76.0	76.0		
<b>Protection category</b>		IP 66 to IEC 60 529, complies with NEMA 4X			IP 55 to IEC 60 529, complies with NEMA 12				
<b>Accessories</b>									
Rails for interior installation		4	2373.300	2373.300	2373.300	2373.300	2373.300	459	
Rain canopy	1.4301 (AISI 304)	1	2474.000	2475.000	2475.000	2363.000	2363.000	431	
Wall mounting bracket	1.4301 (AISI 304)	4	2433.000	2433.000	2433.000	2433.000	2433.000	–	
	1.4404 (AISI 316L)	4	–	–	–	–	–	2433.500	
Wall angle	1.4301 (AISI 304)	4	2583.010	2583.010	2583.010	2583.010	2583.010	440	
Cam lock 1.4404 (AISI 316L)	Standard	1	2304.000	2304.000	–	2304.000	–	–	
	Hygienic Design	1	2304.010	2304.010	–	2304.010	–	–	
Alternative lock systems		see page 414							



## Rittal Japan

RITTAL K.K.  
Sales HQ.  
Shin-Yokohama AK Bldg 2F  
3-23-3, Shin-Yokohama, Kohoku-ku  
Kanagawa 222-0033  
Phone: 0120-998-631 / +81 (45) 478-6801  
Fax: 0120-998-632 / +81 (45) 478-6880  
E-mail: [contact@rittal.co.jp](mailto:contact@rittal.co.jp) • [www.rittal.co.jp](http://www.rittal.co.jp)



System accessories Page 355 AE sheet steel Page 44 AE EMC shielded Page 179 AE Ex-proof Page 176 Hygienic Design Page 154

### Perfect protection in a tough environment

The compact enclosure AE in IP 69K is the ideal solution when a high protection category combined with corrosion resistance is needed.

- **Resistant to high-pressure cleaning** (protection category IP 69K). The interior seal is protected against direct hosed water.
- Ideal for mounting on vehicles: Lock, hinges and mounting plate are all vibration resistant.
- 10° roof tilt prevents liquids from accumulating on the roof.
- Foamed-in silicone seal. The closed cell structure of the foam means that water absorption is negligible. Temperature resistant from -60°C to +180°C.

### Material:

- Enclosure, hinge and lock: Stainless steel 1.4301 (AISI 304)
- Door: Stainless steel 1.4301 (AISI 304), all-round foamed-in PU seal
- Mounting plate: Sheet steel

### Surface finish:

- Enclosure and door: Brushed, grain 240
- Mounting plate: Zinc-plated

### Protection category:

IP 69K to DIN 40 050-9, complies with NEMA 4X.

### Supply includes:

- Enclosure of all-round solid construction
- Single-door
- Interchangeable door hinge
- Cam lock with double-bit insert
- Mounting plate.

### Detailed drawing:

Available on the Internet.

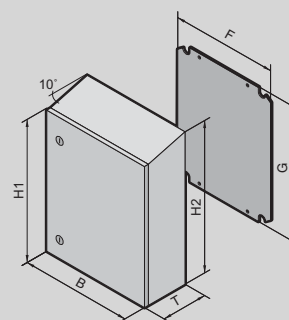

## Compact enclosures AE, protection category IP 69K

Width (B) mm	Packs of	230	400	400	650	Page
Height, front (H1) mm		330	400	650	650	
Height, rear (H2) mm		352	439	689	689	
Depth (T) mm		155	250	250	250	
Mounting plate width (F) mm		162	334	334	549	
Mounting plate height (G) mm		275	355	570	570	
Mounting plate thickness mm		2	2	2.5	2.5	
<b>Model No. AE</b>	<b>1</b>	<b>1101.110</b>	<b>1101.120</b>	<b>1101.130</b>	<b>1101.140</b>	
Locks		1	1	2	2	
<b>Accessories</b>						
Interior door	1	1101.910	1101.920	1101.930	1101.940	406
Door stay	1	1101.800	1101.800	1101.800	1101.800	429
Wall mounting bracket, stainless steel 1.4301 (AISI 304)	4	2433.000	2433.000	2433.000	2433.000	439
Cable glands		see page 519				

# Stainless steel



System accessories Page 355 TFT monitor Page 606 Support arm system CP-S, stainless steel Page 168 Hygienic Design Page 154

## Optionally with or without keyboard housing

- **Resistant to high-pressure cleaning** (protection category IP 69K). The seal lies between two seals and is optimally compressed by the screw fastening.
- **Suitable for clean room use** Screw fastening to comply with high standards in the food industry. With plastic stoppers on the inside or hex screws on the outside.

- **Optimum EMC conditions** The labyrinth seal achieves a particularly high level of RF shielding of the enclosure.
- **Accessibility** Internal rear panel bracket. This solution is clearly superior to external hinges from a hygiene point of view.
- **Handling** Two duct connectors between the enclosures.

**Material:**  
Stainless steel 1.4301 (AISI 304)

**Surface finish:**  
Brushed, grain 240

**Protection category:**  
IP 69K to DIN 40 050-9

**Clean room:**  
Air purity class 1 to DIN EN ISO 14 644-1

**Detailed drawings:**  
Available on the Internet.

Photo shows a configuration example with equipment not included in the scope of supply.

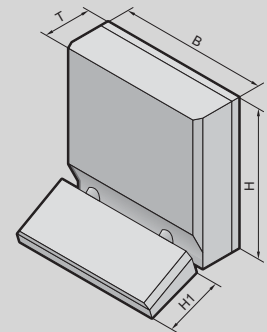

## Premium Panel, protection category IP 69K

		Packs of	Premium Panel	
			With keyboard housing	Without keyboard housing
<b>Model No. CP</b>		1	<b>6680.000<sup>1)</sup></b>	<b>6681.000</b>
<b>Width (B) mm</b>			530	530
<b>Height mm</b>	Operating housing (H)		460	360
	Keyboard housing (H1)		200	–
<b>Depth mm</b>	Operating housing (T)		120	120
For installation panel W x H	Operating housing		482.6 mm (19") x 354.8 mm (8 U)	482.6 mm (19") x 310 mm (7 U)
	Keyboard housing		482.6 mm (19") x 177 mm (4 U)	–
Installation depth mm	Operating housing		115	115
	Keyboard housing		Front 58 Rear 63	–
Support arm connection			Top	Top, or bottom by rotating the enclosure

<sup>1)</sup> Extended delivery times.



**System accessories** Page 355 **TFT monitor** Page 606 **Support arm system CP-S, stainless steel** Page 168 **Hygienic Design** Page 154

**Material:**

- Enclosure and door: Stainless steel 1.4301 (AISI 304)
- Handle strips: Plastic approved for use with foodstuffs

**Surface finish:**

Brushed, grain 240

**Colour:**

Handle strips: Similar to RAL 5002

**Protection category:**

IP 66 to IEC 60 529

**Supply includes:**

- Enclosure of all-round solid construction
- Cut-out and reinforcement for support arm system
- Fastener with guide plate
- Door with sealing frame and side handle strips
- The support arm connection and door hinge may be swapped over by rotating the enclosure

**Approvals:**

- UL
- cUL

**Detailed drawings:**

Available on the Internet.

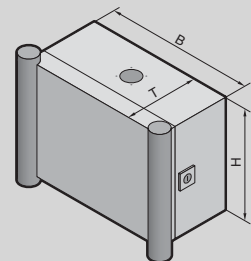

## Command panel housing with door

Width (B) mm	Packs of	300	400	400	600	Page
Height (H) mm		300	300	400	400	
Depth (T) mm		150	150	150	150	
<b>Model No. CP</b>	1	<b>6535.010</b>	<b>6536.010</b>	<b>6538.010</b>	<b>6539.010</b>	
Weight (kg)		6.3	7.5	8.8	12.1	

**Accessories**

Matching mounting plate from AE		1033.500	1030.500	1380.500	1039.500	44/45	
<b>ID no.</b>		0271.926	0274.131	0271.548	0271.351		
Support rails <sup>1)</sup>	<b>Model No. SZ</b>	10	2316.000	2317.000	2317.000	2319.000	467

Alternative lock systems With 3 mm double-bit lock insert, may be exchanged for 41 mm lock inserts, version C, see page 421, plastic handles and T handles, version C, see page 420.

<sup>1)</sup> Only with vertical attachment of punched rail 23 x 23 mm, see page 463.



## Rittal USA

RITTAL Corporation  
 1 Rittal Place · Urbana, OH 43078, USA  
 Phone: +1 (937) 399-0500  
 Fax: +1 (937) 390-5599  
 Toll-free: 1-800-477-4000  
 E-mail: rittal@rittal-corp.com  
 www.rittal-corp.com

# Stainless steel



Stainless steel enclosures Page 166 – 167 Support section CP-S, steel Page 128

## Support section CP-S, stainless steel

Attached to the connection components via 2 clamping screws.

### Size:

- External diameter: 48.3 mm
- Wall thickness: 3 mm

### Material:

Stainless steel

### Surface finish:

Brushed, grain 240 (support section and wall console only)

### Protection category:

IP 69K to DIN 40 050-9 (resistant to high-pressure cleaning)

### Supply includes:

Support section CP-S







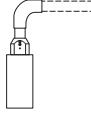
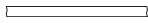
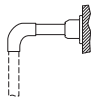

### Detailed drawings:

Available on the Internet.



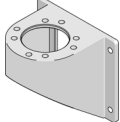

# Stainless steel

		Rotating/tilting	Rigid	Length mm	Weight kg	Material	Enclosure section 	Desk section 	Wall section 
		Model No. CP							
<b>Tilting adaptor 10°</b>									
		-	■	-	0.7	1.4305 (AISI 303)	<b>6664.100</b>	-	-
<b>Enclosure attachment CP-S, stainless steel</b>									
		-	■	-	1.3	1.4305 (AISI 303)	<b>6664.500</b>	-	-
<b>Housing coupling CP-S stainless steel</b>									
		■	-	-	1.1	1.4305 (AISI 303)	<b>6664.000</b>	-	-
<b>Support section CP-S, stainless steel</b>									
		-	■	500 1000	2.0 3.9	1.4301 (AISI 304)		<b>6660.050</b> <b>6660.010</b>	
<b>Angle piece 90° CP-S stainless steel</b>									
		-	■	-	1.3	1.4305 (AISI 303)	<b>6664.300</b>	-	<b>6664.300</b>
<b>Wall/base mount, rigid, CP-S stainless steel</b>									
		-	■	-	1.7	1.4305 (AISI 303)	-	-	<b>6663.000</b>
<b>Wall/base mount, rotating, CP-S stainless steel</b>									
	Rear, thread M8 Front, hole Ø 9 mm	■	-	-	3.9 4.5	1.4305 (AISI 303)	-	-	<b>6663.500</b> <b>6663.400</b>
<b>Wall console CP-S stainless steel</b>									
	Rear, thread M8 Front, hole Ø 9 mm	-	■	-	1.5 1.8	1.4301 (AISI 304)	-	-	<b>6665.000</b> <b>6665.500</b>

## Load information

Permissible load depending on system configuration

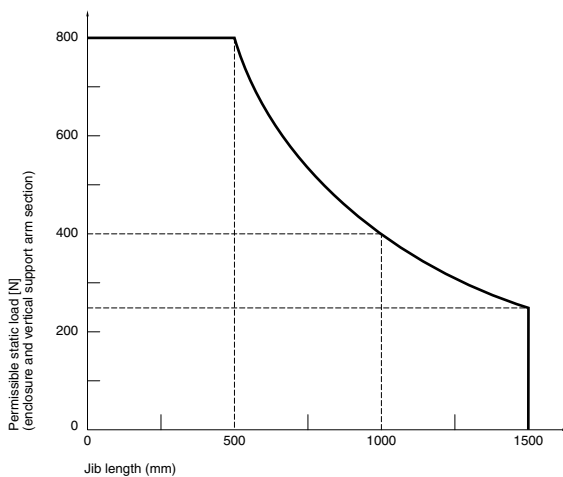

# Stainless steel



System accessories Page 355 Monitors, keyboards Page 606/608 Climate control Page 207 One-piece consoles, sheet steel Page 106

## Material:

- Enclosure: Stainless steel 1.4301 (AISI 304), 1.5 mm
- Door or double door and console lid: Stainless steel 1.4301 (AISI 304), 2.0 mm
- Mounting plate: Sheet steel, 3.0 mm

## Surface finish:

- Enclosure, door, console lid and gland plates: Brushed, grain 120
- Mounting plate: Zinc-plated

## Protection category:

IP 55 to IEC 60 529, complies with NEMA 12.

## Supply includes:

- Enclosure, solid rear and sides
- Door or double door at front, with locking rod
- Console lid with lid stay and cam lock latched in the enclosure
- Cam lock with double-bit insert
- Gland plates, divided
- Mounting plate

## Approvals:

- UL
- CSA
- TÜV
- Germanischer Lloyd
- Russian Maritime Register of Shipping
- Lloyds Register of Shipping
- VDE

## Detailed drawings:

Available on the Internet.

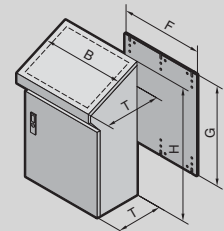

## One-piece consoles AP

Width (B) mm	Packs of	600	800	1000	1200	Page
Height (H) mm		960	960	960	960	
Depth (T) mm	Bottom	400	400	400	400	
	Top	480	480	480	480	
Mounting plate width (F) mm		530	730	930	1130	
Mounting plate height (G) mm		780	780	780	780	
<b>Model No. AP</b>	<b>1</b>	<b>2683.600</b>	<b>2684.600</b>	<b>2685.600</b>	<b>2686.600</b>	
Door(s)		1	1	2	2	
Weight (kg)		52.0	65.2	79.5	90.3	
<b>Accessories</b>						
Base/plinth	Height 100 mm	1	2865.000	2869.000	2867.000	370
	Height 200 mm	1	2875.000	2878.000	2885.000	370
Cable clamp rail		2	4191.000	4192.000	4336.000	527
Support rail TS 35/15		6	4934.000	4935.000	4933.000	467
Hose-proof hood						see page 303
Alternative lock systems						see page 414



System accessories Page 355 PC enclosure systems, sheet steel Page 108

**Material:**

- Enclosure: Stainless steel 1.4301 (AISI 304), 1.8 mm
- Rear door: Stainless steel 1.4301 (AISI 304), 2.0 mm
- Gland plates: Stainless steel 1.4301 (AISI 304) 1.5 mm
- Monitor field: Single-pane safety glass, 4 mm

**Surface finish:**

Brushed, grain 240

**Protection category:**

IP 55 to IEC 60 529, complies with NEMA 12.

**Supply includes:**

- Enclosure, solid top and sides
- Rear door with locking rod
- Glazed door at the top, latched from the inside
- Component shelf
- Lock insert, lock no. 3524 E
- Keyboard drawer with front, swing-down for handrest and mouse pad support
- Bottom door with locking rod
- Gland plate, divided
- Lock with double-bit insert

**Approvals:**

- UL
- CSA
- TÜV
- Germanischer Lloyd
- Russian Maritime Register of Shipping
- Lloyds Register of Shipping
- VDE

**Detailed drawings:**

Available on the Internet.

## PC enclosure systems

<b>Width (B) mm</b>	Packs of	600	
<b>Height (H) mm</b>		1600	
<b>Depth (T) mm</b>		620	
<b>Model No. PC</b>	1	<b>4650.000</b>	
Weight (kg)		115	
<b>Accessories</b>			
Base/plinth, height 100 mm	1	2855.000	370
Levelling feet, 100 mm high	1 set	2859.000	374
Base/plinth trim, modular	4	2913.000	367
Adaptor pieces, 482.6 mm (19")	8	4547.000	552
TFT holder, vertically hinged	1	2383.040	607
Component shelf, pull-out	1 set	6902.960	480
Cable clamp rail	2	4191.000	527
Connector gland		see page 523	
LED system light	1	4140.840	494
Compact light	1	4140.210	493
Alternative lock systems		see page 414	

# Stainless steel



System accessories Page 355 Baying systems TS 8, sheet steel Page 70

## Material:

- Enclosure frame, roof, rear panel and gland plates: Stainless steel 1.4301 (AISI 304), 1.5 mm
- Door(s): Stainless steel 1.4301 (AISI 304), 2.0 mm
- Mounting plate: Sheet steel, 3.0 mm

## Surface finish:

- Enclosure frame and gland plates: Uncoated
- Door(s), roof, rear panel: Exterior brushed, grain 400
- Mounting plate: Zinc-plated

## Protection category:

IP 55 to IEC 60 529, complies with NEMA 12.

## Supply includes:

- Enclosure frame with door(s)
- Mounting plate
- Gland plates
- Rear panel
- Roof
- Locking rod with double-bit insert

## Note:

Due to the hardness of the material, we recommend using metal multi-tooth screw SZ 2486.300, see page 478, for the interior installation.

## Approvals:

- UL
- CSA
- TÜV
- Russian Maritime Register of Shipping
- TÜV Mark
- Lloyds Register of Shipping
- Bureau Veritas
- VDE
- Germanischer Lloyd

## Detailed drawings:

Available on the Internet.

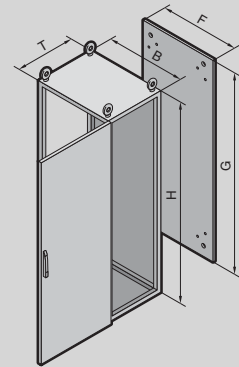

## Baying systems TS 8

Width (B) mm	Packs of	800	1200	600	800	1200	600	800	1200	Page	
Height (H) mm		1800	1800	1800	1800	1800	2000	2000	2000		
Depth (T) mm		400	400	500	500	500	600	600	600		
Mounting plate width (F) mm		699	1099	499	699	1099	499	699	1099		
Mounting plate height (G) mm		1696	1696	1696	1696	1696	1896	1896	1896		
<b>Model No. TS</b>	<b>1</b>	<b>8454.600</b>	<b>8456.600</b>	<b>8457.600</b>	<b>8455.600</b>	<b>8453.600</b>	<b>8452.600</b>	<b>8450.600</b>	<b>8451.600</b>		
Door(s)		1	2	1	1	2	1	1	2		
Support strips		–	–	–	–	–	2	2	2		
Weight (kg)		112.9	170.4	92.5	116.3	174.9	104.4	129.7	194.7		
<b>Walls</b>											
Side panels	2	8700.840	8700.840	8700.850	8700.850	8700.850	8700.060	8700.060	8700.060	385	
Divider panel	1	8609.840	8609.840	8609.850	8609.850	8609.850	8609.060	8609.060	8609.060	389	
Divider panel for module plates	1	–	–	8609.100	8609.100	8609.100	8609.130	8609.130	8609.130	390	
<b>Base/plinth</b>											
Components front and rear	Height 100 mm	1 set	8701.800	8701.200	8701.600	8701.800	8701.200	8701.600	8701.800	8701.200	367
	Height 200 mm	1 set	8702.800	8702.200	8702.600	8702.800	8702.200	8702.600	8702.800	8702.200	367
Trim panels, sides	Height 100 mm	1 set	8701.040	8701.040	8701.050	8701.050	8701.050	8701.060	8701.060	8701.060	367
	Height 200 mm	1 set	8702.040	8702.040	8702.050	8702.050	8702.050	8702.060	8702.060	8702.060	367
Base/plinth trim, modular	4	2907.000	2907.000	2908.000	2908.000	2908.000	2913.000	2913.000	2913.000	367	
<b>Accessories</b>											
Cable clamp rails	2	4192.000	4196.000	4191.000	4192.000	4196.000	4191.000	4192.000	4196.000	527	
Cable entry plates	2	8700.800	8700.120 <sup>1)</sup>	8700.600	8700.800	8700.120 <sup>1)</sup>	8700.600	8700.800	8700.120 <sup>1)</sup>	511	
Wiring plan pocket, sheet steel	1	4118.000	4116.000	4116.000	4118.000	4116.000	4116.000	4118.000	4116.000	429	
Alternative lock systems		see page 414									
System lights		see page 491									

<sup>1)</sup> Packs of 4





# Ex enclosures/EMC enclosures

---

## Ex enclosures

Stainless steel.....	176
Plastic .....	177

## EMC enclosures

The Rittal EMC concept.....	178
EMC E-Box EB.....	178
EMC compact enclosures AE .....	179

**Note:**

All TS 8 enclosures prepared for pressurisation on request.



# Ex enclosures



## System accessories Page 355

### Application range:

- Zone 1 and 2 or 21 and 22 to 94/9/EC
- Ambient temperature range: -30°C to +80°C
- Protection type to IEC 60 079: Equipment protection thanks to increased safety, equipment protection thanks to enclosure

### Material:

- Enclosure: Stainless steel 1.4301 (AISI 304)
- Cover or door: Stainless steel 1.4301 (AISI 304), all-round foamed-in silicone seal
- Mounting plate: Sheet steel

### Surface finish:

- Enclosure: Brushed, grain 240
- Mounting plate: Zinc-plated

### Protection category:

IP 66 to IEC 60 529

### Supply includes:

- Enclosure
- Cover or door
- Mounting plate (only for enclosures with door)

### Certificates:

- Enclosure with cover:
  - PTB 03 ATEX 1013U
  - IEC Ex PTB 09.0033U

### Enclosure with door:

- PTB 02 ATEX 1082U
- IEC Ex PTB 09.0035U

### Approvals:

- ATEX
- IEC

### Detailed drawing:

Available on the Internet.

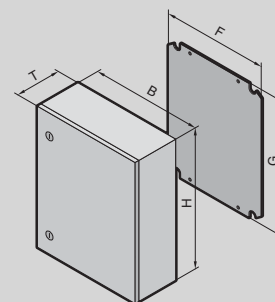

## Stainless steel, with screw-fastened cover

Width (B) mm	Packs of	150	200	300	300	300	400	Page
Height (H) mm		150	200	150	200	300	200	
Depth (T) mm		80	80	80	80	120	120	
Model No. KEL	1	9301.000	9303.000	9302.000	9304.000	9306.000	9305.000	
Weight (kg)		1.3	1.8	1.8	2.4	3.9	3.6	

### Accessories

Mounting plates		1560.700	1562.700	1561.700	1563.700	1567.700	1564.700	443
Wall mounting bracket <sup>1)</sup>	4	1594.000	1594.000	1594.000	1594.000	1594.000	1594.000	439
Support rails TS 35/7.5	10	2314.000	2315.000	2316.000	2316.000	2316.000	2317.000	467
Earth straps		see page 501						

## Stainless steel, with hinged door

Width (B) mm	Packs of	200	300	380	380	380	600	600	760	800	Page
Height (H) mm		300	380	300	380	600	600	760	760	1000	
Depth (T) mm		155	210	155	210	210	210	210	300	300	
Mounting plate width (F) mm		162	334	334	334	334	549	549	704	739	
Mounting plate height (G) mm		275	275	275	355	570	570	730	730	955	
Model No. KEL	1	9401.600	9409.600	9402.600	9403.600	9404.600	9405.600	9406.600	9407.600	9408.600	
Cam lock with double-bit insert		1	1	1	1	2	2	2	2	2	
Weight (kg)		3.8	7.7	7.4	9.7	13.3	15.6	22.3	30.5	36.3	

### Accessories

Wall mounting bracket <sup>1)</sup>	4	2433.000	2433.000	2433.000	2433.000	2433.000	2433.000	2433.000	2433.000	2433.000	439
Support rails TS 35/7.5	10	2315.000	2316.000	-	-	-	2319.000	2319.000	-	-	467
Rails for interior installation	4	-	2373.210	-	2373.210	2373.210	2373.210	2373.210	2373.300	2373.300	459
Perforated mounting strip	20	-	2310.038	-	2310.038	-	-	-	-	-	427
Earth straps		see page 501									

<sup>1)</sup>Stainless steel 1.4301 (AISI 304)





## System accessories Page 355

### Application range:

- Zone 1 and 2 or 21 and 22 to 94/9/EC
- Ambient temperature range: -30°C to +80°C
- Protection type to IEC 60 079: Equipment protection thanks to increased safety, equipment protection thanks to enclosure

### Material:

- Enclosure: Fibre-glass-reinforced unsaturated polyester, surface resistance:  $< 10^9 \Omega$
- Door: Fibre-glass-reinforced unsaturated polyester, surface resistance:  $< 10^9 \Omega$ , all-round foamed-in silicone seal
- Mounting plate: Sheet steel, zinc-plated

### Colour:

RAL 9011

### Protection category:

IP 66 to IEC 60 529

### Supply includes:

- Enclosure
- Door
- Mounting plate

### Certificates:

- PTB 03 ATEX 1011U
- IEC Ex PTB 10.0011U

### Approvals:

- ATEX
- IEC

### Detailed drawing:

Available on the Internet.

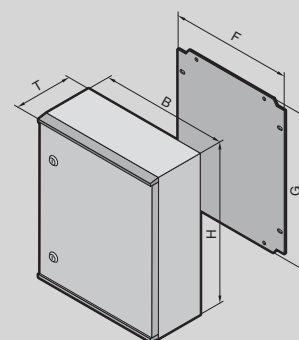

## Plastic

Width (B) mm	Packs of	200	250	300	400	400	500	600	600	800	Page
Height (H) mm		300	350	400	400	600	500	600	800	1000	
Depth (T) mm		150	150	200	200	200	300	200	300	300	
Mounting plate width (F) mm		145	195	245	345	345	417	545	517	717	
Mounting plate height (G) mm		250	300	350	350	550	450	550	750	950	
<b>Model No. KEL</b>	1	<b>9201.600</b>	<b>9202.600</b>	<b>9203.600</b>	<b>9204.600</b>	<b>9205.600</b>	<b>9207.600</b>	<b>9206.600</b>	<b>9208.600</b>	<b>9209.600</b>	
Cam lock with double-bit insert		1	1	2	2	2	2	2	-	-	
3-point locking rod		-	-	-	-	-	-	-	■	■	
Weight (kg)		3.7	4.6	6.0	6.5	11.5	12.9	15.9	24.3	39.0	

### Accessories

Wall mounting bracket	4	9266.000	9266.000	9266.000	9266.000	9266.000	9266.000	9266.000	9266.000	9266.000	440
Threaded inserts M6	20	1482.000	1482.000	1482.000	1482.000	1482.000	1482.000	1482.000	1482.000	1482.000	478
Mounting plate adjustment bracket	4	1481.000	1481.000	1481.000	1481.000	1481.000	1491.000	1481.000	1491.000	1491.000	446
Support rails		see page 466									
Earth straps		see page 501									
Cable duct		see page 525									

# EMC enclosures

## The Rittal EMC concept

Rittal offers excellent pre-requisites for EMC enclosure configurations in the form of its standard sheet steel enclosures, EMC-shielded enclosures, and a practical range of EMC accessories. Depending on the individual application, anything is possible, be it closely intermeshed potential equalisation in a standard enclosure to prevent conducted interference, or extra shielding to protect against high-frequency electromagnetic fields.

For Rittal EMC enclosures with a high level of shielding, excellent attenuation levels and attractive value-for-money products are achieved on the basis of zinc-plated metal surfaces in conjunction with low-resistance EMC shields.

Empty enclosures and mechanical accessory components are not subject to the European EMC Directive and the German EMC Act.

Thanks to the basic design in conjunction with the metal-plated enclosure body, even standard enclosures offer a good shielding effect against electrical fields, which in many cases is sufficient. The large enclosures in the TS 8 series offer a good level of shielding across a broad frequency range, even in the standard version.

For increased EMC requirements, Rittal offers the TS 8 enclosure in a version certified by the VDE with high RF attenuation. This shielding concept is also transferred to other enclosure platforms. Further information on the topic of EMC may be found on our website at [www.rittal.com](http://www.rittal.com).



## EMC E-Box EB

### Material:

Sheet steel with aluminium zinc coating

### Surface finish:

- Powder-coated on the outside
- Interior surfaces conductive

### Colour:

RAL 7035

### Protection category:

- IP 55 to IEC 60 529
- The EMC version ("high RF attenuation") has been certified by the VDE.

### Note:

All sizes available on request.



EMV

## EMC compact enclosures AE

**Material:**

Sheet steel with aluminium zinc coating

**Surface finish:**

- Powder-coated on the outside
- Interior surfaces conductive

**Colour:**

RAL 7035

**Protection category:**

- IP 55 to IEC 60 529
- The EMC version ("high RF attenuation") has been certified by the VDE.

**Note:**

All sizes available on request.

**Approvals:**

Available on the Internet.





# Outdoor enclosures

---

## CS wall-mounted enclosures

Double-walled ..... 182

## CS New Basic enclosures

Single-walled and one-door, width: 600 and 800 mm ..... 183

Single-walled and two-door, width: 1200 mm ..... 184

## CS Toptec

Double-walled, platform TS 8 ..... 185

## CS modular enclosures

Double-walled, configuration variants, width: 600 mm ..... 186

Double-walled, configuration variants, width: 800 and 1200 mm ..... 187

# CS wall-mounted enclosures



Compact enclosures AE, stainless steel Page 162 Compact enclosures AE, stainless steel, protection category IP 69K Page 165

Outdoor enclosures for wall or pole mounting.  
Enclosure-within-an-enclosure concept, outer enclosure with cut-out at the bottom and integrated louvres on the rear panel and side panels for ventilation.

**Material:**

- Enclosure: Aluminium AlMg3
- Mounting plate: Sheet steel, zinc-plated

**Surface finish:**

- Powder-coated
- UV-resistant pure polyester

**Colour:**

RAL 7035

**Protection category:**

IP 55 to IEC 60 529

**Supply includes:**

- Double-walled outdoor enclosure, fully pre-configured:
- Inner enclosure with mounting plate, gland plate and security lock (CS 9791.045 with 2 security locks)
  - Mounting bracket for thermostat or hygostat
  - Outer enclosure with designer cover and security lock 3524 E
  - 2 C rails on the rear panel

**Detailed drawing:**

Available on the Internet.

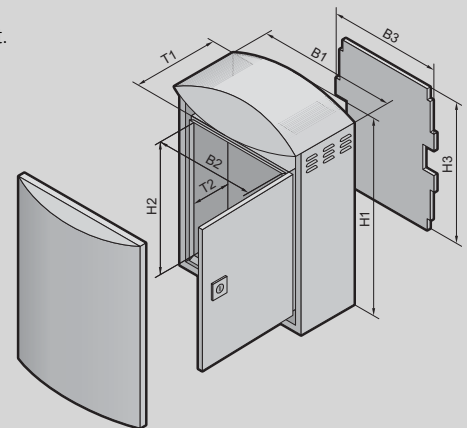

## Double-walled

Outer enclosure						
Width (B1) mm	Packs of	370	420	530	630	Page
Height (H1) mm		522	560	700	780	
Depth (T1) mm		210	210	265	380	
Inner enclosure						
Width (B2) mm		300	350	460	580	
Height (H2) mm		400	440	565	580	
Depth (T2) mm		170	170	220	333	
Clearance width mm		280	330	440	560	
Clearance height mm		380	420	545	560	
Clearance depth mm		145	145	195	308	
Mounting plate width (B3) mm		270	320	430	550	
Mounting plate height (H3) mm		380	410	535	550	
<b>Model No. CS</b>	1	<b>9791.015</b>	<b>9791.025</b>	<b>9791.035</b>	<b>9791.045</b>	
Accessories						
Wall mounting bracket	4	9765.120	9765.120	9765.120	9765.120	441
Pole clamp	1 set	2584.000	2584.000	2584.000	2584.000	441
Enclosure heaters	1	3105.330	3105.330	3105.330	3105.330	289
Enclosure internal thermostat	1	3110.000	3110.000	3110.000	3110.000	294
Hygostat	1	3118.000	3118.000	3118.000	3118.000	294
Socket	2	2506.100	2506.100	2506.100	2506.100	508
LED system light	1	4140.810	4140.810	4140.820	4140.820	494
LED connection cable	1	4315.800	4315.800	4315.800	4315.800	495
Adaptor power pack	1	4315.860	4315.860	4315.860	4315.860	495

# CS New Basic enclosures



Climate control Page 285 Rail systems Page 464 Cable management Page 525

Outdoor enclosure with 100 mm transport plinth and rain canopy with projections on all sides. Photo shows a configuration example with equipment not included in the scope of supply.

**Material:**  
Aluminium AIMg3

**Surface finish:**  
– Powder-coated  
– UV-resistant pure polyester

**Colour:**  
RAL 7035

**Protection category:**  
IP 55 to IEC 60 529, complies with NEMA 3R in conjunction with the gland plates offered in the accessories.

**Supply includes:**  
Single-walled outdoor enclosure, fully pre-configured:  
– Basic enclosure with open base  
– 25 mm system punchings in the roof, base, front and in the enclosure depth  
– Front door(s) with door stay, swing lever handle and semi-cylinder, lock BJ20027  
– Transport plinth with screw-fastened trim panels front and rear

– Enclosure with width 1200 mm has two 600 mm wide mounting panels  
– Rain canopy

**Detailed drawing:**  
Available on the Internet.

**Note:**  
When configuring with partial mounting panels or 482.6 mm (19") partial installation, punched rails are required in the enclosure height, see page 463.

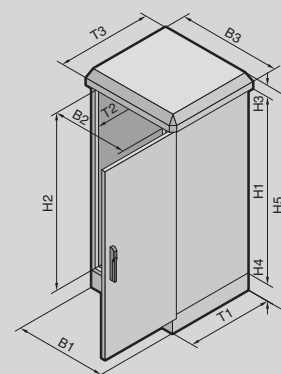

## Single-walled and one-door, width: 600 and 800 mm

Width (B1) mm	Packs of	600	600	600	800	800	800	Page
Height (H1) mm		800	1200	1200	800	1200	1200	
Depth (T1) mm		400	400	500	400	400	500	
Clearance width (B2) mm		512	512	512	712	712	712	
Clearance height (H2) mm		712	1112	1112	712	1112	1112	
Clearance depth (T2) mm		349	349	449	349	349	449	
Rain canopy width (B3) mm		650	650	650	850	850	850	
Rain canopy height (H3) mm		55	55	55	55	55	55	
Rain canopy depth (T3) mm		450	450	550	450	450	550	
Base/plinth height (H4) mm		100	100	100	100	100	100	
Overall height (H5) mm		955	1355	1355	955	1355	1355	
<b>Model No. CS</b>	1	<b>9783.540</b>	<b>9783.550</b>	<b>9783.530</b>	<b>9783.510</b>	<b>9783.520</b>	<b>9783.610</b>	

Accessories								
Concrete base/plinth	1	9765.182	9765.182	9765.082	9765.088	9765.088	9765.084	368
Gland plate, divided	1 set	9785.511	9785.511	9785.514	9785.512	9785.512	9785.513	384
Cable entry plates	2	8800.060	8800.060	8800.060	8800.080	8800.080	8800.080	511
Mounting plates	1	9765.090	9765.092	9765.092	9765.097	9765.095	9765.095	451
Mounting angles, 482.6 mm (19")	2	7685.000	7688.000	7688.000	7685.000	7688.000	7688.000	553
Installation kit for mounting angles	2	7696.000	7696.000	7696.000	7698.000	7698.000	7698.000	553
Enclosure heaters	1	3105.400	3105.400	3105.400	3105.400	3105.400	3105.400	289
Enclosure internal thermostat	1	3110.000	3110.000	3110.000	3110.000	3110.000	3110.000	294
Semi-cylinder, alternative closure	1	9785.040	9785.040	9785.040	9785.040	9785.040	9785.040	416

# CS New Basic enclosures

Single-walled and two-door, width: 1200 mm

Width (B1) mm	Packs of	1200	1200	Page	
Height (H1) mm		1200	1200		
Depth (T1) mm		400	500		
Clearance width (B2) mm		512	512		
Clearance height (H2) mm		1112	1112		
Clearance depth (T2) mm		349	449		
Rain canopy width (B3) mm		1250	1250		
Rain canopy height (H3) mm		55	55		
Rain canopy depth (T3) mm		450	550		
Base/plinth height (H4) mm		100	100		
Overall height (H5) mm		1355	1355		
<b>Model No. CS</b>	1	<b>9784.620</b>	<b>9784.520</b>	<b>9784.640</b>	<b>9784.540</b>
Without centre bar, overlapping doors		■	–	■	–
With removable centre bar, 2 lockable doors		–	■	–	■
<b>Accessories</b>					
Concrete base/plinth	1	9765.089		9765.086	368
Gland plate, divided	1 set	2 x 9785.511		2 x 9785.514	384
Cable entry plates	2	8800.060		8800.060	511
Mounting plate for one half of the enclosure	1	9765.092		9765.092	451
Mounting plate, full installation	1	9765.191		9765.191	451
Mounting angles, 482.6 mm (19")	2	7688.000		7688.000	553
Installation kit for mounting angles	2	7696.000		7696.000	553
Enclosure heaters	1	3105.400		3105.400	289
Enclosure internal thermostat	1	3110.000		3110.000	294
Semi-cylinder	1	9785.040	–	9785.040	–
	2	–	9785.042	–	9785.042



## Rittal Australia

RITTAL Pty. Ltd.  
 130 – 140 Parraweena Road  
 Miranda NSW 2228  
 Phone: +61 (2) 9525 2766  
 Fax: +61 (2) 9525 2888  
 E-mail: [info@rittal.com.au](mailto:info@rittal.com.au) • [www.rittal.com.au](http://www.rittal.com.au)





Climate control Page 285 Rail systems Page 456 Cable management Page 525

Outdoor enclosure with 100 mm transport plinth and rain canopy with projections on all sides. Side panels, rear panel and door fully double-walled on the outside, the entire TS 8 frame is available for interior installation.

**Material:**

- Enclosure frame: Stainless steel 1.4301 (AISI 304)
- Enclosure panels and base/plinth trim: Aluminium, AIMg3

**Surface finish:**

- Powder-coated
- UV-resistant pure polyester

**Colour:**

RAL 7035

**Protection category:**

IP 55 to IEC 60 529

**Supply includes:**

- Double-walled outdoor enclosure, fully pre-configured:
  - TS 8 frame with 25 mm system punchings in the roof and base frame plus vertical sections with two mounting levels
  - Front door with door stay, swing lever handle and semi-cylinder, lock BJ20027
  - Side panels left and right

- Rear panel
- Rain canopy
- Base/plinth with screw-fastened gland plates and screw-fastened trim panels front and rear
- All enclosure panels are doubled and earthed (external wall onto internal wall)

**Detailed drawing:**

Available on the Internet.

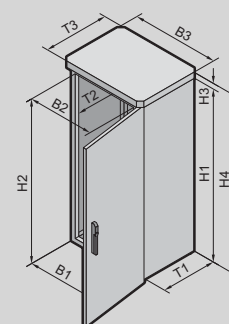

## Double-walled, platform TS 8

Width (B1) mm	Packs of	600	800	600	800	Page
Height (H1) mm		1200	1200	1600	1600	
Depth (T1) mm		600	600	600	600	
Clearance width (B2) mm		512	712	512	712	
Clearance height (H2) mm		1112	1112	1512	1512	
Clearance depth (T2) mm		512	512	512	512	
Rain canopy width (B3) mm		694	894	694	894	
Rain canopy height (H3) mm		45	45	45	45	
Rain canopy depth (T3) mm		694	694	694	694	
Overall height (H4) mm		1345	1345	1745	1745	
<b>Model No. CS</b>	1	<b>9774.105</b>	<b>9774.205</b>	<b>9774.305</b>	<b>9774.405</b>	
<b>Accessories</b>						
Concrete base/plinth	1	9765.071	9765.072	9765.071	9765.072	368
Mounting angles, 482.6 mm (19°)	2	7827.120	7827.120	7827.160	7827.160	549
TS punched section with mounting flange as installation kit	4	8612.060	-	8612.060	-	459
Installation bracket TS	2	-	7827.480	-	7827.480	556
Mounting plate	1	9765.092	9765.095	-	9765.096	451
Gland plate	Size	4	4	4	4	From 514
	Qty.	2	2	2	2	
Semi-cylinder	1	9785.040	9785.040	9785.040	9785.040	416
Cooling unit, 1000 W	1	-	9776.500	-	9776.500	286
Heat exchanger, 85 W/K	1	-	9776.102	-	9776.102	286

# CS modular enclosures



**System accessories** Page 355

## CS modular enclosures

Double-walled outdoor enclosure with base/plinth and rain canopy projecting on all sides. Side panels doubled up to the outside, door and rear panel to the inside.

Photo shows a configuration example with equipment not included in the scope of supply.

### Material:

- Enclosure, roof and side panel:  
Aluminium AlMg3
- Base/plinth, battery plinth:  
Aluminium AlMg3

### Surface finish:

- Powder-coated
- UV-resistant pure polyester

### Colour:

RAL 7035

### Protection category:

IP 55 to IEC 60 529, complies with NEMA 3R.

**Order example,**  
see page 187.

**Other climate control devices,**  
from page 285.

**Detailed drawings:**  
Available on the Internet.

## Double-walled, configuration variants, width: 600 mm

Width mm	600	600	600	600	Page
Height mm	800	1000	1200	1600	
Depth mm	600	500	600	600	
<b>Model No. CS</b>	<b>9751.015</b>	<b>9751.075</b>	<b>9751.025</b>	<b>9751.035</b>	
<b>Base/plinth</b>					
Standard base/plinth 100 mm	<b>9755.015</b>	<b>9755.065</b>	<b>9755.015</b>	<b>9755.015</b>	
Battery plinth 350 mm	<b>9754.025</b>	<b>9754.015</b>	<b>9754.025</b>	<b>9754.025</b>	
<b>Roof-mounted climate control</b>					
Cooling unit, 1000 W	9762.212	9762.212	9762.212	9762.212	287
Heat exchanger, 30 W/K	9764.040	9764.040	9764.040	9764.040	287
Mounting frame for cooling unit	9765.051	9765.051	9765.051	9765.051	287
Climate hood	<b>9756.015</b>	<b>9756.065</b>	<b>9756.015</b>	<b>9756.015</b>	
<b>Wall-mounted climate control</b>					
Cooling unit, 1000 W	-	-	9761.212	9761.212	287
<b>Roof</b>					
Standard roof	<b>9757.015</b>	<b>9757.065</b>	<b>9757.015</b>	<b>9757.015</b>	
Roof for wall-mounted climate control	-	-	<b>9758.015</b>	<b>9758.015</b>	
<b>Side panel</b>					
Side panel for 100 mm base/plinth	<b>9753.015</b>	<b>9753.175</b>	<b>9753.035</b>	<b>9753.045</b>	
Side panel for 350 mm base/plinth	<b>9753.055</b>	<b>9753.195</b>	<b>9753.075</b>	<b>9753.085</b>	
Side panel for 100 mm base/plinth and roof-mounted climate control	<b>9753.095</b>	<b>9753.185</b>	<b>9753.115</b>	<b>9753.125</b>	
Side panel for 350 mm base/plinth and roof-mounted climate control	<b>9753.135</b>	<b>9753.205</b>	<b>9753.155</b>	<b>9753.165</b>	

Delivery times available on request.

# CS modular enclosures

Double-walled, configuration variants, width: 800 and 1200 mm

Width mm	800	800	800	800	1200	1200	Page
Height mm	1000	1200	1200	1600	1200	1200	
Depth mm	500	500	600	600	500	600	
<b>Model No. CS</b>	<b>9751.085</b>	<b>9751.045</b>	<b>9751.055</b>	<b>9751.065</b>	<b>9752.015</b>	<b>9752.025</b>	
<b>Base/plinth</b>							
Standard base/plinth 100 mm	<b>9755.025</b>	<b>9755.025</b>	<b>9755.035</b>	<b>9755.035</b>	<b>9755.045</b>	<b>9755.055</b>	
Battery plinth 350 mm	<b>9754.035</b>	<b>9754.035</b>	<b>9754.045</b>	<b>9754.045</b>	2 x <b>9754.015</b>	2 x <b>9754.025</b>	
<b>Roof-mounted climate control</b>							
Cooling unit, 1000 W	9762.212	9762.212	9762.212	9762.212	9762.212	9762.212	287
Heat exchanger, 30 W/K	9764.040	9764.040	9764.040	9764.040	9764.040	9764.040	287
Mounting frame for cooling unit	9765.051	9765.051	9765.051	9765.051	9765.051	9765.051	287
Climate hood	<b>9756.025</b>	<b>9756.025</b>	<b>9756.035</b>	<b>9756.035</b>	<b>9756.045</b>	<b>9756.055</b>	
<b>Wall-mounted climate control</b>							
Cooling unit, 1000 W	-	9761.212	9761.212	9761.212	9761.212	9761.212	287
<b>Roof</b>							
Standard roof	<b>9757.025</b>	<b>9757.025</b>	<b>9757.035</b>	<b>9757.035</b>	<b>9757.045</b>	<b>9757.055</b>	
Roof for wall-mounted climate control	-	<b>9758.025</b>	<b>9758.035</b>	<b>9758.035</b>	<b>9758.045</b>	<b>9758.055</b>	
<b>Side panel</b>							
Side panel for 100 mm base/plinth	<b>9753.175</b>	<b>9753.025</b>	<b>9753.035</b>	<b>9753.045</b>	<b>9753.025</b>	<b>9753.035</b>	
Side panel for 350 mm base/plinth	<b>9753.195</b>	<b>9753.065</b>	<b>9753.075</b>	<b>9753.085</b>	<b>9753.065</b>	<b>9753.075</b>	
Side panel for 100 mm base/plinth and roof-mounted climate control	<b>9753.185</b>	<b>9753.105</b>	<b>9753.115</b>	<b>9753.125</b>	<b>9753.105</b>	<b>9753.115</b>	
Side panel for 350 mm base/plinth and roof-mounted climate control	<b>9753.205</b>	<b>9753.145</b>	<b>9753.155</b>	<b>9753.165</b>	<b>9753.145</b>	<b>9753.155</b>	

Delivery times available on request.

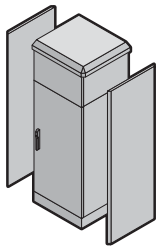

**Order example: Enclosure 800 x 1200 x 500 mm of aluminium AlMg3 with standard base/plinth and roof-mounted cooling unit.**

**You will need:**

<b>Enclosure:</b>	Basic enclosure 800 x 1200 x 500 mm	<b>CS 9751.045</b>
<b>Base/plinth:</b>	Standard base/plinth 100 mm	<b>CS 9755.025</b>
<b>Roof-mounted climate control:</b>	Roof-mounted cooling unit	<b>CS 9762.212</b>
	Mounting frame	<b>CS 9765.051</b>
	Climate hood	<b>CS 9756.025</b>
<b>Roof:</b>	Standard roof	<b>CS 9757.025</b>
<b>Side panel:</b>	Side panel for 100 mm base/plinth and roof-mounted climate control	<b>CS 9753.105</b>



## Rittal Belgium

RITTAL nv/sa  
 Industrieterrein E17/3206 · Stokkelaar 8  
 B-9160 Lokeren  
 Phone: +32 (0) 9 353 9111  
 Fax: +32 (0) 9 355 6862  
 E-mail: info@rittal.be · www.rittal.be



# Power

## UPS – Power Modular Concept

PMC 12/PMC 12 compact.....	190
PMC 40 (type 1-4).....	191
PMC 40 (type 5).....	192
PMC 120.....	193
PMC 200.....	194
PMC 800.....	195
PMC accessories.....	196

## Power Distribution Rack

Power Distribution Rack PDR.....	200
Power Distribution Module PDM.....	200

## Power System Module

PSM Plus busbar.....	201
PSM Plus plug-in modules.....	201
PSM busbars.....	202
PSM socket modules.....	203
PSM accessories.....	204

## Fuel cell system

RiCell Flex.....	205
------------------	-----



## Rittal UPS systems Power Modular Concept

Ensuring UPS protection of all processes whose availability is crucial is more than just a question of kilowatts, autonomy and UPS redundancy. The key here is to protect the critical load with a high UPS efficiency.

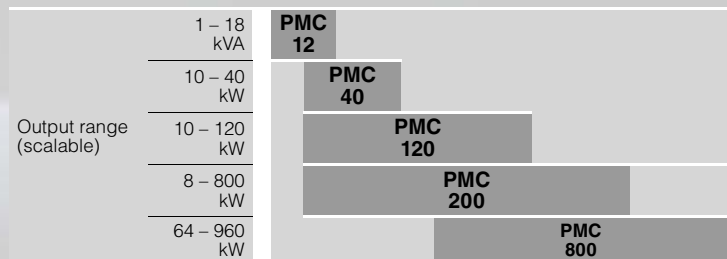

# UPS – Power Modular Concept



Shutdown software Page 347 Battery packs Page 196

Double conversion technology to the highest classification VFI-SS-111.

**Supply includes:**

- Single-phase UPS system
- Operating manual
- Software on CD-ROM
- RS232 cable
- For 1 – 3 kVA:  
UPS, earthing-pin connection cable, USB cable



**Also required:**

Country-specific connection cables and slide rails are required to operate the UPS systems, see page 585/559.

**Technical information:**

Available on the Internet.

Photo shows a configuration example with equipment not included in the scope of supply.

## PMC 12, single-phase, output range 1 – 12 kVA n+1

UPS for 482.6 mm (19") racks or as floor-standing enclosures		UPS with integral battery					UPS control unit		Page
<b>Internal hot swap-compatible batteries</b>		■	■	■	■	■	-	-	
<b>Model No. DK PMC 12</b>		<b>7857.482</b>	<b>7857.483</b>	<b>7857.430</b>	<b>7857.431</b>	<b>7857.432</b>	<b>7857.433</b>	<b>7857.434</b>	
Width x height mm		440 (19") x 176 (4 U)			440 (19") x 88 (2 U)				
Depth mm		420	420	405	650	650	680	680	
Weight kg		26	27	15,7	26	29	24	24	
<b>Power</b>	VA	2000	3000	1000	2000	3000	4500	6000	
	Watts	1600	2400	800	1600	2400	3500	4800	
	Max. heat loss (W)	105	262	105	210	252	315	420	
<b>Input</b>	Rated voltage	230 V (160 – 288 V)							
	Frequency	50/60 Hz ±5%							
	Power factor	> 0.99 with linear load							
<b>Output</b>	Voltage	230 V ±1% (200/208/220/230/240 V adjustable)							
	Frequency, synchronised	±1 Hz							
	Efficiency, AC mode	88%	90%	88%	88%	90%	90%	90%	
	Power factor	0.8							
<b>Battery</b> 5 years EUROBAT	Autonomy at 100% load	≥ 7 min.	≥ 5 min.	≥ 7 min.	≥ 7 min.	≥ 5 min.	≥ 12 min. <sup>1)</sup>	≥ 8 min. <sup>1)</sup>	
	Interface	1 x USB, 1 x RS232					1 x RS232		
<b>Communication</b>	SNMP	Optional network monitoring card DK 7857.420/relay card 7857.410							
	Operating systems supported	Windows, Unix, Linux, Novell, Apple; RCCMD shutdown licence DK 7857.421							
	Emergency Power Off (EPO)	■							
<b>Connection</b>	Input connection 230 V	10 A C14	16 A C20	10 A C14		16 A C20	Compact connector		
	Output connection 230 V	6 x 10 A, C13, 2 units switched	4 x 10 A, C13, 2 units switched, 1 x 16 A, C19	6 x 10 A, C13, 2 units switched		4 x 10 A, C13, 2 units switched, 1 x 16 A, C19	Compact connector		
<b>Standards and certifications</b>	Power	IEC/EN 62 040-3							
	EMC	EN 50 091-2/EN 62 040-2 class A, EN 61 000-4-2/-3/-4/-6-8/-11, EN 61 000-3-2/-3							
	Labelling	CE, FCC							
<b>Accessories</b>									
Battery pack PMC 12		see page 196							
Connection cable at output end, UPS, single-phase, for PSM busbar		7856.027	7856.030	7856.027	7856.027	7856.030	-	-	204

■ Included with the supply. <sup>1)</sup> With an external battery pack

# UPS – Power Modular Concept



Shutdown software Page 347

Double conversion technology to the highest classification VFI-SS-111.

**Supply includes:**

- Basic module and UPS module(s) fitted to specifications.
- Battery pack(s), separate

**Service:**

Commissioning by Rittal.

**Technical information:**

Available on the Internet.

Photo shows a configuration example with equipment not included in the scope of supply.

## PMC 40 (type 1-4), 3-phase, output range scalable 10 – 40 kW

		Type 1	Type 2	Type 3	Type 4	Page
Number of UPS modules	Qty.	1	1	2	2	
Number of battery packs	Qty.	1	2	2	4	
Maximum UPS output (with 10 kW/20 kW module)	kW	10	10/20	20	20/40	
UPS output with 1+1 redundancy (with 10 kW/20 kW module)	kW	–	–	10	10/20	
Approx. autonomies at 100% load (10 kW/20 kW modules)	min.	6/–	15/5	6/–	16/5	
Approx. autonomies at 50% load (10 kW/20 kW modules)	min.	12/–	30/10	12/–	32/10	
RS232 (D-Sub 9) and USB interface (configuration and shutdown)	Qty.	1/1	1/1	1/1	1/1	
Fault signal contacts (floating)	Qty.	5	5	5	5	
Clamping strip input/output (3L+N+PE) max. conductor cross-section	mm <sup>2</sup>	10/16	10/16	10/16	10/16	
Dimensions	Width	mm	485 (19")	485 (19")	485 (19")	485 (19")
	Height	U	11	15	18	26
	Depth	mm	735	735	735	735
Required distance between 482.6 mm (19") levels (min./max.)	mm	690 – 800	690 – 800	690 – 800	690 – 800	
Weight (approx. incl. batteries and UPS modules)	kg	162	278	310	537	
<b>Model No. DK basic unit</b>		<b>7040.010</b>	<b>7040.020</b>	<b>7040.030</b>	<b>7040.040</b>	
<b>Model No. DK PMC 40 10 kW module (order quantity acc. to type)</b>	Qty.	<b>1 x 7040.110</b>	<b>1 x 7040.110</b>	<b>2 x 7040.110</b>	<b>2 x 7040.110</b>	
<b>Model No. DK PMC 40 20 kW module (order quantity acc. to type)</b>	Qty.	–	<b>1 x 7040.120</b>	–	<b>2 x 7040.120</b>	
<b>Model No. DK PMC 40 battery pack each n x 4 x 10 batteries (12 V/7 Ah) prewired</b>	Packs of	<b>7040.211</b>	<b>7040.212</b>	<b>7040.212</b>	<b>7040.214</b>	
<b>Model No. DK PMC 40 battery preparation (for export or air freight) Drawers and battery cabling (excluding battery, quantity depending on type)</b>	Packs of	<b>7040.201</b>	<b>7040.202</b>	<b>7040.202</b>	<b>7040.204</b>	
<b>Accessories</b>						
SNMP monitoring card (budget)	Packs of			7857.420		198
RCCMD licence, bundle of 5 licences	Packs of			7857.423		347
RCCMD licence, bundle of 25 licences	Packs of			7857.424		347

**Note:** Only UPS modules with an identical output may be combined.

### PMC 40 modules, rack-independent

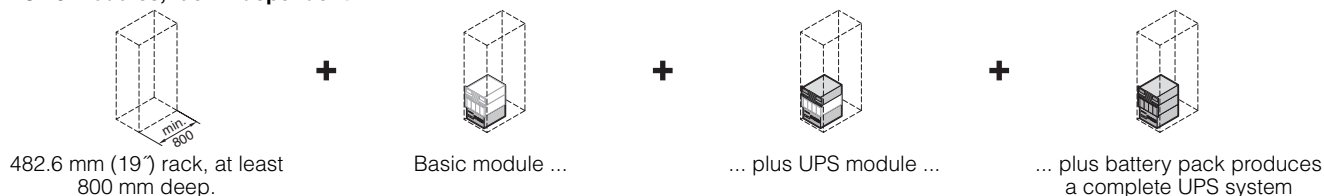

# UPS – Power Modular Concept



Shutdown software Page 347

## UPS rack with integral power modules and batteries

- Thanks to the double conversion technology (VFI-SS-111) the output voltage is independent from the input voltage and frequency
- Efficient IGBT power transistor technology achieves a high operating ratio of 95% even in part-load operation

- “Safe swap” compatibility with a redundant design, i.e. the module may be exchanged while operational
- Every UPS module includes power electronics as well as the control unit including display
- Installation, commissioning and servicing to be carried out by authorised experts only

## Supply includes:

- UPS system in the TS 8 rack
- Vented front door and rear panel
- Fitted with UPS power modules (depending on configuration) and batteries
- The batteries must only be installed at the point of assembly and are delivered separately

## Note:

Only UPS modules with an identical output may be combined.

## Technical information/ battery configurations:

Available on the Internet.

Photo shows a configuration example with equipment not included in the scope of supply.

## PMC 40 (type 5), 3-phase, output range scalable 10 – 40 kW, redundant

Dimensions (UPS rack, without base/plinth) width x height x depth mm	Packs of	600 x 2000 x 800	600 x 2000 x 1000	Page
<b>Model No. UPS basic rack</b>		<b>7040.065</b>	<b>7040.060</b>	
Maximum no. of UPS modules		3		
Maximum no. of batteries		240 (4 x 50, 6 x 40)		
Maximum UPS output (with 10 kW/20 kW modules)		30/60 kW		
UPS output with n+1 redundancy (with 10 kW/20 kW modules)		20/40 kW		
RS232 (D-Sub 9) and USB interface (configuration and shutdown)		1/1		
Fault signal contacts (floating)		5		
Clamping strip input/output (3L+N+PE) max. conductor cross-section		35/50 mm <sup>2</sup>		
Weight (approx. incl. batteries and 3 UPS modules)		740 kg		
Protection category of UPS system		IP 20		
Operating temperature range (UPS with batteries, recommended)		20 – 25°C		
Accessibility only required to front (for servicing, maintenance)		900 mm		
Distance from wall at rear (due to fan cooling)		200 mm		
<b>Model No. PMC 40 10 kW module (order quantity acc. to output)</b>	1	<b>7040.110</b>		
<b>Model No. PMC 40 20 kW module (order quantity acc. to output)</b>	1	<b>7040.120</b>		
<b>Model No. PMC 40 battery pack 1 x 4 x 10 batteries, when using 10 kW modules</b> (12 V/7 Ah) prewired (service life 5 years under EUROBAT) Order volume n = 1-6 x	40	<b>7040.311</b>		
<b>Model No. PMC 40 battery pack 1 x 5 x 10 batteries, when using 20 kW modules</b> (12 V/7 Ah) prewired (service life 5 years under EUROBAT) Order volume n = 1-4 x	50	<b>7040.315</b>		
<b>Model No. PMC 40 battery preparation n x 4 x 10 (for export or air freight)</b> Drawers and battery cabling (n = 1-6 x, <b>without batteries</b> ), cable set of 40	1 set	<b>7040.301</b>		
<b>Model No. PMC 40 battery preparation n x 5 x 10 (for export or air freight)</b> Drawers and battery cabling (n = 1-4 x, <b>without batteries</b> ), cable set of 50	1 set	<b>7040.305</b>		
<b>Accessories</b>				
UPS monitoring/SNMP monitoring card	1	7857.420		198
Base/plinth components, front and rear, RAL 7035, 100 mm high	1 set	8601.605		361
Base/plinth trim panels, side, RAL 7035, 800 mm deep/100 mm high	1 set	8601.085		362
Base/plinth trim panels, side, RAL 7035, 1000 mm deep/100 mm high	1 set	8601.015		362



# UPS – Power Modular Concept



Shutdown software Page 347

## Modular UPS system (up to 120 kW)

- UPS power modules operate according to the double conversion principle (classification to VFI-SS-111) and have a transformerless design thanks to the high intermediate circuit voltage
- Efficient IGBT power transistor technology achieves a high operating ratio of 95% even in part-load operation

- “Safe swap” compatibility with a redundant design, i.e. the module may be exchanged while operational
- Every UPS module includes power electronics as well as the control unit including display
- Installation, commissioning and servicing to be carried out by authorised experts only

## Supply includes:

- UPS system in the TS 8 rack
- Vented front door and rear panel
- Fitted with UPS power modules (depending on configuration) and batteries

## Note:

Only UPS modules with an identical output may be combined.

## Technical information/ battery configurations:

Available on the Internet.

Photo shows a configuration example with equipment not included in the scope of supply.

## PMC 120, 3-phase, output range scalable 10 – 120 kW

Dimensions (UPS rack, without base/plinth) width x height x depth mm	Packs of	600 x 2000 x 800	600 x 2000 x 1000	Page
<b>Model No. UPS basic rack</b>		<b>7040.075</b>	<b>7040.070</b>	
Maximum no. of UPS modules		6		
Maximum UPS output (with 10 kW/20 kW modules)		60/120 kW		
UPS output with n+1 redundancy (with 10 kW/20 kW modules)		50/100 kW		
No. of batteries (12 V/28 Ah) per module/battery bank (per 10 kW/20 kW)		40/50		
No. of battery banks per battery rack <sup>1)</sup> , max.		3		
No. of batteries (12 V/28 Ah) per battery rack <sup>1)</sup> , max.		150		
Operating ratio (from 50% load)		95%		
Operating ratio in eco-mode (100% load)		98%		
RS232 (D-Sub 9) and USB interface (configuration and shutdown)		1/1		
Fault signal contacts (floating)		5		
Input (3L+N+PE) conductor cross-section		70/95 mm <sup>2</sup>		
Output (3L+N+PE) conductor cross-section		70/95 mm <sup>2</sup>		
Battery connection (3 x M10, joint batteries) conductor cross-section		150 mm <sup>2</sup>		
Weight (approx., UPS rack with 6 UPS modules)		285 kg		
Protection category of UPS system		IP 20		
Operating temperature range (UPS with batteries, recommended)		20 – 25°C		
Accessibility only required to front (for servicing, maintenance)		900 mm		
Distance from wall at rear (due to fan cooling)		200 mm		
<b>Model No. PMC 40 10 kW module (order quantity acc. to output)</b>	1	<b>7040.110</b>		
<b>Model No. PMC 40 20 kW module (order quantity acc. to output)</b>	1	<b>7040.120</b>		
<b>Also required</b>				
<b>Battery rack, width 800 mm (max. 150 batteries)</b>	1	<b>7040.361<sup>1)</sup></b>	<b>7857.364<sup>1)</sup></b>	
<b>Accessories</b>				
Base/plinth components, front and rear, RAL 7035, 600 mm wide/100 mm high	1 set	8601.605		361
Base/plinth trim panels, side, RAL 7035, 800 mm deep/100 mm high	1 set	8601.085		362
Base/plinth trim panels, side, RAL 7035, 1000 mm deep/100 mm high	1 set	8601.015		362

<sup>1)</sup> Batteries not included with the supply of the battery rack, connection cable for battery racks DK 7040.371.

# UPS – Power Modular Concept



Shutdown software Page 347

Rittal PMC 200 ensures optimum availability for critical applications by combining modularity (flexible scalability and redundancy, whereby up to 20 modules may be switched in parallel) with decentralised parallel architecture or DPA (redundant protection without a "single point

of failure"). Transformerless, genuine online, double-conversion UPSs with static bypass and classification code VFI-SS-111.

This modular concept keeps the purchasing and operating costs of redundant solutions low. As your performance requirements grow, the UPS grows with you – even in the most confined spaces, and with the system operational. The benefits to you:

Less capital tie-up, inexpensive expansion, and minimal space requirements.

**Technical information:**  
Available on the Internet.

Photo shows a configuration example with equipment not included in the scope of supply.

## PMC 200, 3-phase, output range scalable 8 – 800 kW

Up to 20 PMC modules may be gradually switched in parallel e.g. in order to supply 800 kW without redundancy or 760 kW n+1 (with 40 kW modules) uninterrupted. May be upgraded with the system operational; no need to switch over to an unprotected network.



**Note:**

This table contains only sample configurations. We would be pleased to configure your individual solution with you.

Examples of 32 and 40 kW module configurations and autonomies

	without		with		without		with		without		with	
UPS rack/battery rack	1/-	-	1/-	1/-	1/-	1/-	1/2	1/2	1/2	1/2	1/2	1/2
Number of UPS modules	1	-	2	2	3	3	4	4	5	5	5	5
<b>PMC 32 module type, output in kW</b>	<b>32</b>	-	<b>64</b>	<b>32</b>	<b>96</b>	<b>64</b>	<b>128</b>	<b>96</b>	<b>160</b>	<b>128</b>	<b>160</b>	<b>128</b>
Battery autonomy <sup>1)</sup>	18	-	9	9	9	9	12	12	12	12	12	12
<b>PMC 40 module type, output in kW</b>	<b>40</b>	-	-	-	-	-	<b>160</b>	<b>120</b>	<b>200</b>	<b>160</b>	<b>160</b>	<b>160</b>
Battery autonomy <sup>1)</sup>	15	-	-	-	-	-	9	9	9	9	9	9

<sup>1)</sup> Minutes/modules with cos φ 1.0/autonomy may be extended to order. Delivery times available on request.

### PMC 200 modules



Minimum floor space is required by a rack with three modules (2+1 redundancy) and batteries with autonomy integrated into a single rack. The Rittal PMC 200 allows the integration of up to 5 modules (4+1 redundancy) in one rack. For this configuration, an additional battery rack is required. The autonomy may be flexibly adapted to suit your requirements.

# UPS – Power Modular Concept



Shutdown software Page 347

Rittal PMC 800 is the solution for data centres with a high power consumption. The modular architecture allows optimum, tailored configuration of the UPS.

The PMC 800 may be extended to accommodate up to 12 modules, facilitating a maximum output of up to 960 kW or 880 kW (n+1), redundant. If a UPS with a higher output is required, this can of course be achieved with the PMC 800.

#### UPS PMC 800 at a glance:

- Topology: On-line, double conversion, VFI-SS-111.
- Technology: Transformerless
- Architecture: Modular, may be connected in parallel
- Maximum output in standard configuration: 800 kW (higher outputs available on request)

- Operating ratio at 25/50/75/100% load (cos phi = 0.8): 92/93.5/95/95%
- Use of battery racks:

**Technical information:**  
Available on the Internet.

Photo shows a configuration example with equipment not included in the scope of supply.

## PMC 800, 3-phase, output range scalable 64 – 960 kW

The separation into one power module and one control module is exemplary for UPS systems in this output class. This ensures a high level of service-friendliness and allows precise planning of maintenance work.

#### Note:

This table contains only sample configurations. We would be pleased to configure your individual solution with you.

#### Examples of 64 and 80 kW module configurations

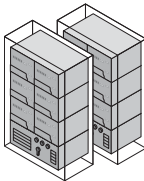
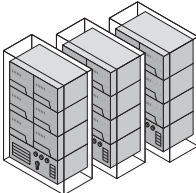
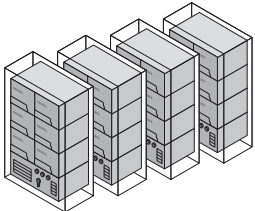
PMC 800								
	without	with	without	with	without	with	without	with
Redundancy (n+1)								
Module with 64 kW	192	128	384	320	576	512	768	704
Module with 80 kW	240	160	480	400	720	640	960	880
Batteries	Battery rack, e.g. 28 Ah batteries or battery racks, e.g. 70 Ah batteries							
UPS racks W x H x D mm	1400 x 1900 x 870							

# UPS – Power Modular Concept

## Accessories



### Battery packs

#### for PMC 12

To operate or increase the power of PMC 12 UPS systems. With overload protection. Vertical siting is also possible. Battery packs are "hot plug"-compatible (replacement of batteries while operational). Batteries can be exchanged from the front, without removing the battery pack from the 482.6 mm (19") level. Depending on the UPS version, 2 – 3 battery packs may be connected together to increase the autonomy. Cooling of the UPS and the battery packs is absolutely essential.

#### Material:

Maintenance-free lead gel accumulators, service life 5 years (to EUROBAT)

#### Supply includes:

- Fully preassembled and populated with accumulators (12 V/7 Ah)
- 0.5 m connection cable with connector
- Feet.

#### Note:

For mounting in the 482.6 mm (19") rack, a slide rail DK 7063.883 is required.

	XL version		Standard version				
UPS PMC 12 system	7857.482	7857.483	7857.430	7857.431	7857.432	7857.433	7857.434
<b>Battery packs Model No. DK</b>	<b>7857.488</b>	<b>7857.488</b>	<b>7857.435</b>	<b>7857.437</b>	<b>7857.437</b>	<b>7857.442</b>	<b>7857.442</b>
Width mm	465	465	465	465	465	465	465
Height mm	178 (4 U)	178 (4 U)	89 (2 U)	89 (2 U)	89 (2 U)	133.5 (3 U)	133.5 (3 U)
Depth mm	420	420	650	650	650	650	650
Weight kg	35	35	20	20	20	55	55
Number of batteries per battery pack	12	12	6	6	6	20	20

#### Autonomy (min.) at 100% load:

UPS PMC 12	In supplied state	Battery packs				
		1	1 (XL version)	2	2 (XL version)	3
7857.430, 1 kVA	7 min.	28 min.	–	55 min.	–	–
7857.482/7857.431, 2 kVA	7 min.	17 min.	26 min.	29 min.	54 min.	–
7857.483/7857.432, 3 kVA	5 min.	12 min.	24 min.	20 min.	46 min.	–
7857.433, 4.5 kVA	–	9 min.	–	23 min.	–	39 min.
7857.434, 6 kVA	–	8 min.	–	20 min.	–	33 min.



### Mechanical maintenance bypass

#### for PMC 12

Facilitates uninterrupted removal/maintenance of the UPS. Various designs are required depending on the UPS output category.

Connection of the bypass for 1 – 3 kVA UPS models is via a connector (plug & play), while the 4.5 and 6 kVA UPS variant must be installed by a qualified electrician. It is important to ensure the correct prefuse of the UPS bypass depending on the UPS power used.

#### Dimensions:

- W x H x D (mm):
- 465 x 88 (2 U) x 80 (DK 7857.440)
  - 465 x 88 (2 U) x 350 (DK 7857.441)

		Model No. DK
<b>1</b>	1 – 3 kVA (incl. UPS fuse 16 A)	<b>7857.440</b>
<b>2</b>	4.5 – 6 kVA (incl. UPS fuse 32 A)	<b>7857.441</b>



### Relay card

#### for PMC 12

This card allows the UPS alarm messages (5 UPS alarms) to be forwarded to external indicator devices (e.g. building services management) via floating contacts.

The card is plugged into the extension slot on the rear of the PMC 12 UPS.

Packs of	Model No. DK
1	<b>7857.410</b>

#### Note:

Cannot be used together with the SNMP card.

### Sub-distribution

#### for PMC 12

Outlets 4 x C19 and 2 x 32 A CEE-conforming, single-phase, individually fused. Allows the direct connection of up to 6 pieces of equipment. Installation must be carried out by a qualified electrician.

#### Dimensions:

W x H x D (mm): 482.6 (19") x 131 (3 U) x 300

Packs of	Model No. DK
1	7857.445

#### Technical specifications:

Ambient conditions:

- Temperature: 5 – 40°C
- Humidity: 5 – 90% rel. humidity (non-condensing)
- Input (open ends with wire end ferrules): 3 x 6 mm<sup>2</sup> (2 m)
- Output: 4 x C19 jack, 2 x CEE 32 A coupling
- Fuses: 4 x 16 AC, 2 x 32 A type C



### Plug & play sub-distribution

#### for PMC 12, 4.5 and 6 kVA

This sub-distribution facilitates simple installation and commissioning of the PMC 12 UPS, 4.5 and 6 kVA. All that is needed is a single-phase 32 A connection to DIN/EN 60 309.

#### Dimensions:

W x H x D (mm): 482.6 (19") x 88 (2 U) x 300

Packs of	Model No. DK
1	7857.448

#### Technical specifications:

Ambient conditions:

- Temperature: 5 – 40°C
- Humidity: 5 – 90% rel. humidity (non-condensing)
- UPS connection PMC 12: Via connection cables with fitted Harting connector (1.5 m)
- Input (connection cable): 3 x 4 mm<sup>2</sup> (3 m) with 32 CEE connector, single-phase
- Output: 2 x C19 jack, 4 x C13 jack
- Fuses: 2 x 16 AC, 4 x 10 A type C



### Parallel hot swap chassis

#### for PMC 12, 4.5 and 6 kVA

Facilitates parallel switching of 2 (or 3) PMC UPS systems to increase the output or redundancy of the UPS. A mechanical maintenance bypass is also integrated.

Parallel connection is only possible with the 4.5 and 6 kVA PMC 12 version. The two UPS systems to be connected in parallel must have identical battery configurations (number/type of battery packs). The autonomy of the system will not be increased as a result of parallel connection. Installation must be carried out by a qualified electrician.

#### Dimensions:

W x H x D (mm): 482.6 (19") x 88 (2 U) x 300

	for UPS systems	Packs of	Model No. DK
1	2	1	7857.443
2	3	1	7857.444

#### Technical specifications:

Ambient conditions:

- Temperature: 5 – 40°C
- Humidity: 5 – 90% rel. humidity (non-condensing)
- UPS connection PMC 12: Via connection cables with fitted Harting connector (1 m)
- Input (connection cable): 3 x 10/16 mm<sup>2</sup> (2 m) with open cable end and wire end ferrules
- Output (connection cable): 3 x 10/16 mm<sup>2</sup> (2 m) with open cable end and wire end ferrules
- Fuses (UPS input): 2 x 2 x 32 A type C (for DK 7857.442) 3 x 2 x 32 A type C (for DK 7857.443)

#### Note:

Commissioning of a PMC 12 UPS connected in parallel must only be carried out by a member of the Rittal Service team because the UPS may be destroyed if wrongly configured. Additionally, we recommend the use of the PMC 12 sub-distribution (DK 7857.445).



# UPS – Power Modular Concept

## Accessories



### Sub-distribution

#### for PMC 40 UPS

Allows the direct, fused connection of single- and 3-phase equipment. In this way, up to 4 PSM bus-bars may be connected directly to the PMC 40 UPS via the relevant connection cables.

Additionally, there are six single-phase outlets (16 A) available via C19 jacks.

Connection to the PMC 40 UPS must be carried out by a qualified electrician.

#### Dimensions:

W x H x D: 482.6 (19") x 131 mm (3 U) x 300 mm

Packs of	Model No. DK
1	<b>7040.500</b>

#### Technical specifications:

Ambient conditions:

- Temperature: 5 – 40°C
- Humidity:
  - 5 – 90% rel. humidity (non-condensing)
- Input (open ends with wire end ferrules):
  - 5 x 16 mm<sup>2</sup> (2 m)
- Output:
  - 4 x GST18 (3-phase), 6 x C19 (1-phase)
- Fuses:
  - 18 x 16 AC

#### Note:

Observe the country-specific connection data.

Plug & play connection cable for server enclosures:

Length	Packs of	Model No. DK
3 m	1	7857.130
5 m	1	7857.150
8 m	1	7857.180
9 m	1	7857.190

### Sub-distribution, modular

#### for PMC 200

The distributor may be fitted directly in the UPS PMC 200 rack. This allows the configuration of a complete, compact system with a 0.6 m<sup>2</sup> footprint containing a rack-mounted modular UPS PMC 200, batteries and distributor.

#### Application range:

UPS systems Rittal Power Modular Concept PMC 200 up to 20 kW N+1.

#### Technical specifications:

- 482.6 mm (19") , 6 U
- 12 outlets, three-phase 400 V/50 Hz with 10 A
- On-load isolator for disconnecting
- Circuit-breaker 10 A per phase

Design	Model No. DK
482.6 mm (19"), 6 U	<b>7857.372</b>

#### Supply includes:

482.6 mm (19") modules, 6 U, instructions.

#### Note:

Observe the country-specific connection data.

Plug & play connection cable for server enclosures:

Length	Packs of	Model No. DK
3 m	1	7857.130
5 m	1	7857.150
8 m	1	7857.180
9 m	1	7857.190



#### Also required:

UPV PMC 200, 60 kW, see page 194.

### UPS monitoring card (SNMP card)

This optional monitoring card facilitates monitoring of the UPS via Web browsers. In this way, various monitoring states of the UPS (e.g. input voltage, output currents/power per phase, battery charging status, autonomies etc.) may be remotely monitored. However, the main application is a controlled server shutdown via the network interface. To this end, a UPS shutdown client (RCCMD software) must be installed and configured on every server.

Design	Packs of	Model No. DK
SNMP card, budget version	1	<b>7857.420</b>
SNMP card CS121 with switching contacts	1	<b>7857.366</b>

#### Note:

Only one extension card may be installed per UPS system.

Redundant monitoring solutions for UPS systems available on request.

RCCMD software, see page 347.

### Battery Manager RiBat

#### for PMC 200/800

Management system for the batteries in a UPS. RiBat can extend the service life of a battery by up to 30%.

#### Benefits:

- Optimised charging for each individual battery.
- Temperature monitoring per battery.
- Early identification of defective batteries.
- Supports preventive maintenance of batteries.
- Defective batteries can be restored rather than replaced before reaching the end of their useful life.
- RiBat Manager replaces the internal SNMP card of the UPS.

The Rittal battery manager RiBat determines all relevant data such as battery voltage, internal resistance, discharge curve, temperature etc. throughout the service life of the monitored batteries. This data is evaluated and used to control the charging process. RiBat facilitates optimum charging of each individual battery.

The RiBat module regulates the charging process for each connected battery. This avoids overcharging of a battery which is connected to other batteries. This technology can extend the service life of a battery by up to 30%. The RiBat modules are connected using preassembled cables and connected to the RiBat Manager.

Up to 250 modules may be connected to one RiBat Manager.

Designation	Model No. DK
1 RiBat Manager	7857.800
2 RiBat module	7857.801
RiBat cable kit 120 batteries	7857.802 <sup>1)</sup>
RiBat cable kit 150 batteries	7857.803 <sup>2)</sup>

Extended delivery times.

<sup>1)</sup> In conjunction with a battery rack for 120 batteries

<sup>2)</sup> In conjunction with a battery rack for 150 batteries

#### Technical specifications

##### RiBat Manager:

- Supply voltage: 9 – 30 V DC
- Serial interface: 3 x RS232
- LAN interface: 10/100 MBit full/half
- Supported protocols: SNMP, RCCMD, SNMP, HTTP
- Alarm contact: 1 floating contact
- Display: LCD display
- Temperature range: 5°C – 45°C,
- 90% humidity, non-condensing
- Certifications: CEE, WEEE, RoHS

##### RiBat module:

- Battery voltage: 12 V DC
- Battery capacity: 7 – 300 Ah
- W x H x D: 800 x 55 x 27 mm
- Certifications: CEE, WEEE, RoHS



1



2

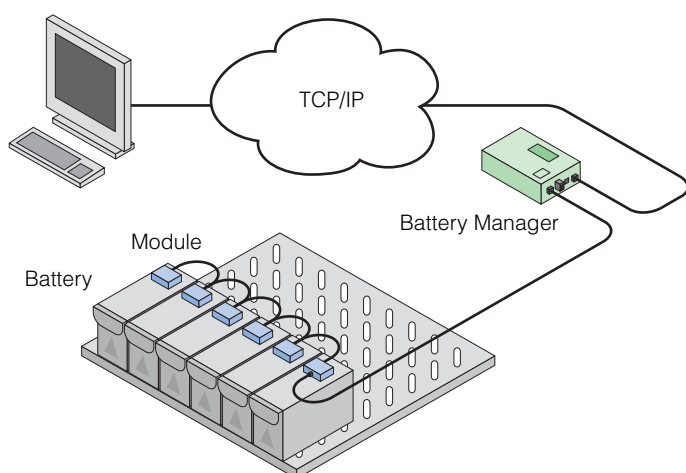

### RCCMD software

#### Client software for controlled server shutdown

see page 347.



# Power Distribution Rack



## Power Distribution Rack PDR

- To accommodate a maximum of 8 PDM
- Height 1.20 m for 4 PDMs and 2 m height for 8 PDMs
- PDM may be retrofitted whilst operational
- A maximum of 32 racks may be fitted to the sub-distributor
- Fully shock-hazard protected
- Main switch in various options:
  - Isolator switch
  - On-load isolator
  - Air circuit-breaker
  - RC circuit-breaker
- Low-voltage distribution up to 250 A

## Material:

Sheet steel

## Surface finish:

- Enclosure frame: Dipcoat-primed
- Doors, roof and base/plinth: Dipcoat-primed, powder-coated
- Gland plates, punched sections with mounting flanges and mounting angles: Zinc-plated, clear-chromated

## Colour:

RAL 7035

## Supply includes:

- Enclosure frame with door (without tubular door frame),
- Rear panel,
- Side panels and roof plate,
- Levelling feet incl. base/plinth adaptor,
- Earthing of all enclosure panels,
- Busbars shock-hazard-protected
- Main switch integral.

## Note:

**Observe the standards of the local power supply companies.**

**Approvals:**  
VDE

## Detailed drawings:

Available on the Internet.

## Power Distribution Module PDM

- Mechanically latchable in the PDR
- Scalable
- RC circuit-breaker, optional

## Supply includes:

- 482.6 mm (19") module, 3 U
- Incl. master switch
- 4 fused 3-phase outlets to the rack
- 3 x 230 V/16 A per outlet
- Connected load 400 V/3 AC, max. 63 A

Photo shows a configuration example with equipment not included in the scope of supply.

## Power Distribution Rack PDR

	Packs of	4	8	Page	
Possible number of PDM modules		4	8		
Dimensions mm	W x H x D	800 x 1200 x 500	800 x 2000 x 500		
<b>Model No. DK</b>	1	<b>7857.310<sup>1)</sup></b>	<b>7857.300<sup>1)</sup></b>		
<b>Accessories</b>					
Base/plinth components front and rear	Height 100 mm	1 set	8601.800	8601.800	361
	Height 200 mm	1 set	8602.800	8602.800	361
Base/plinth trim panels, side	Height 100 mm	1 set	8601.050	8601.050	362
	Height 200 mm	1 set	8602.050	8602.050	362

<sup>1)</sup> Extended delivery times.

## Power Distribution Module PDM

	Packs of	4 outlets per 10 kW	4 outlets project-specific	
Design		4 outlets per 10 kW	4 outlets project-specific	
Dimensions mm	W x H	19" (482.6 mm) x 3 U		
<b>Model No. DK</b>	1	<b>7857.320</b>	<b>7857.350</b>	
<b>Also required</b>				
Plug & play connection cable for PSM busbar to the server enclosures	Length 3 m	1	<b>7857.130</b>	
	Length 5 m	1	<b>7857.150</b>	
	Length 8 m	1	<b>7857.180</b>	
	Length 9 m	1	<b>7857.190</b>	
Connection cable 32 A CEE-conforming connector, for operation without PDR		1	<b>7857.321</b>	



# Power System Module Plus

## Power System Module PSM Plus

**Current carrying capacity up to 192 A per rack**  
Busbar with redundant design and 3-phase infeed.

By integrating two **further** three-phase circuits the PSM Plus now has **four** independent three-phase infeeds. Each of the feeds can be supplied with up to 3 x 16 A, producing a total of max. 192 A. With four independent infeeds, it is possible to assemble a redundant, high-MTBF power supply system for IT racks.

### The benefits at a glance:

- 2 m busbar with four independent infeeds (**A, B, C, D** each 400 V/3~, 50/60 Hz, 3 x 16 A).
- Shock-hazard-protected; may be retrofitted whilst the system is operational.
- With four integral connection cables, each 3 m long, 5 x 2.5 mm<sup>2</sup> and Wieland GST connectors.
- Directly suitable for connecting to Rittal PDM.
- Easily integrated into existing applications with standard extension cables.
- 6 slots per 2 m busbar
- Attachment with no loss of U in the rack.

### Note:

- PSM Plus bar for modules with two infeeds. This means that redundancy can now be achieved at module level.
- Only fits PSM Plus socket modules.

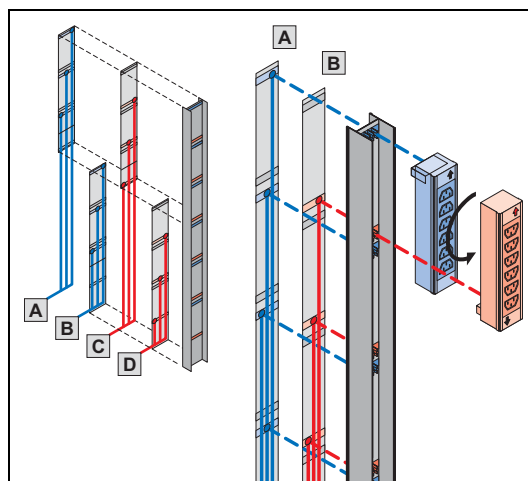

### PSM Plus busbar

For enclosure height mm	Number of modules	Model No. DK
2000	6	7856.015

### PSM Plus plug-in modules

Connector pattern	Number of sockets	
C13	6 (3 x per infeed)	7856.081
C19	4 (2 x per infeed)	7856.231
Earthing-pin	2 (1 x per infeed)	7856.101

### PSM Plus connection cable

Length	Type	Connections	
5 m	3-phase supply connection cable	Three-phase connector EN 60 309 on Wieland GST socket	7856.018
5 m	Extension cable	Wieland GST socket on Wieland GST 18 connector	7856.017



# Power System Module

## PSM busbars



### PSM busbars + PSM socket modules

#### PSM busbars

The modular system facilitates basic configuration of the racks, thanks to a vertical support rail with 1/3-phase infeed. The various socket modules to supply the active components may be snap-fitted into the support rail. This can even be done whilst the system is operational, because the support section is shock-hazard protected.

#### PSM socket modules

The various modules, earthing pins, IEC 320 etc. may be inserted into the support rail in any combination. This is easily achieved, even by non-electricians, thanks to the shock hazard protected plug & play system.

#### Approvals:

Available on the Internet.

#### Technical specifications/benefits:

- Each plug-in module picks off a phase on the support rail, either from infeed **A** or from the redundant infeed **B**, depending on the direction of connection.
- 1-/3-phase construction with a maximum current of 2 x (3 x 16 A).
- 3-phase redundant infeed supported.
- The redundant circuit is completely separate from the 3 phases of the support rail.
- Modules may be retrofitted whilst operational.
- Modules may be equipped with integral over-current protection, so that only the affected module is deactivated in the event of an excessively high current. The other modules remain operational.
- Overvoltage protection may be integrated into the supply line.
- Various modules also available with current measurement and switchable outputs.

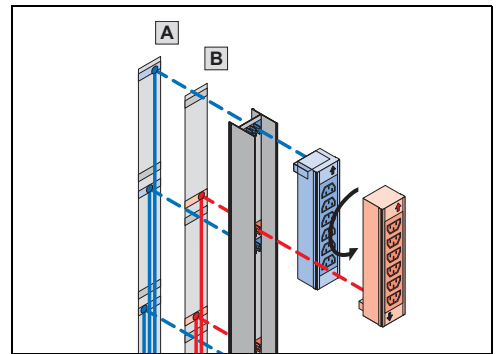

## PSM busbars

For enclosure height mm	Phases per infeed	No. of infeeds	Input current (A)	Maximum no. of module slots	Connection, connector type	Circuit-breaker 16 A	Earth-leakage circuit-breaker RCD	Packs of	Model No. DK
<b>1 With measurement of voltage, current and power (consumption), via CMC, remote-controllable</b>									
2000	3	2	16	6	Jack	–	–	1	<b>7856.016</b>
2000	1	1	32	6	CEE	2	–	1	<b>7856.003</b>
<b>2 With 2 infeeds (jack), 3-phase redundancy</b>									
1200	3	2	16	4	Jack	–	–	1	<b>7856.010</b>
2000	3	2	16	7	Jack	–	–	1	<b>7856.020</b>
2200	3	2	16	8	Jack	–	–	1	<b>7856.008</b>
<b>3 With 3 m connection cable (wire end ferrules)</b>									
2000	3	1	16	7	Wire end ferrules	–	–	1	<b>7856.005</b>
2000	3	2	16	7	Wire end ferrules	–	–	1	<b>7856.006</b>
<b>4 With 3 m connection cable (connector type CEE/EN 60 309)</b>									
2000	1	1	32	6	CEE	2	–	1	<b>7856.321</b>
2000	3	1	32	6	CEE	6	–	1	<b>7856.323</b>
2000	1	1	32	6	CEE	2	■	1	<b>7856.043</b>

#### ! Also required:

PSM socket modules, see page 203.

#### + Accessories:

- Mounting kit for PSM busbars, see page 204.
- Connection cables, see page 204.
- Cable lock, see page 204.
- Overvoltage protection, see page 204.

# Power System Module

## PSM socket modules

### PSM socket modules

Module slots required in PSM busbar	Connector pattern	Slots	Thermal overcurrent protection	Packs of	Model No.
<b>1 Standard socket modules/non-switchable</b>					
1	C13	6	–	1	7856.080
1	C13	6	■	1	7856.070
1	C13	4	■/per output	1	7856.220
1	Earthing-pin	4	–	1	7856.100
1	Earthing-pin	4	■	1	7856.090
1	C19	4	–	1	7856.230
1	C13 red	6	–	1	7856.082
1	Earthing-pin, red	4	–	1	7856.240
2	C13	8	RCD	1	7856.095
<b>2 International socket modules</b>					
1	France/Belgium	4	–	1	7856.120
1	France/Belgium	4	■	1	7856.110
1	Switzerland	5	–	1	7856.190
1	Switzerland	4	■	1	7856.180
1	UK	3	–	1	7856.160
1	UK	3	■	1	7856.150
1	USA (120 V/208 V)	5	–	1	7856.140
1	USA (120 V/208 V)	5	■	1	7856.130
<b>3 Socket modules with LED display/current measurement per module</b>					
1	C13	6	–	1	7859.120
1	C19	4	–	1	7859.130
<b>4 Socket modules with switchable slot/aggregate current measurement per module</b>					
2	C13	8	■	1	7856.201
2	Earthing-pin/C13	4/2	■	1	7856.203
2	C19/C13	4/2	■	1	7856.204
<b>5 Socket modules with switchable slot/individual current measurement per slot</b>					
2	Earthing-pin/C13	4/2	■	1	7859.212
2	C13	8	■	1	7859.222
2	C19/C13	4/2	■	1	7859.232

#### Approvals:

Available on the Internet.



# Power System Module

## Accessories



### Mounting kit for PSM busbars

#### Without cable routing

For		Model No. DK
TS	For static installation	<b>7856.011</b>
TE	For static installation	<b>7000.684</b>

#### With cable routing

For		Model No. DK
TS	For static installation	<b>7856.022</b>
	Adjustable, for freely accessible 482.6 mm (19") level	<b>7856.023</b>



### Connection cable for PSM-busbar

#### Connection cable, 3-phase

	Length	Packs of	Model No. DK
CEE-conforming 5-pole/16 A	3 m	1	<b>7856.025</b>

#### Connection cable, single-phase

CEE-conforming 3-pole/16 A	3 m	1	<b>7856.026</b>
----------------------------	-----	---	-----------------

#### Connection cable, UPS, single-phase

C14/X-Com 10 A	3 m	1	<b>7856.027</b>
C20/X-Com 16 A	3 m	1	<b>7856.030</b>

#### Connection cable C19/C20

16 A	2 m	1	<b>7200.217</b>
------	-----	---	-----------------

#### Connection cable C13/C14

16 A	0.5 m	2	<b>7856.014</b>
------	-------	---	-----------------



### Cable lock PSM

#### for all modules with EN 60 320 C13 connector configurations

All terminal connection cables are therefore protected against unintentional disconnection of the power supply. Two bars are needed for two cables.

Design	Packs of	Model No. DK
Bar	20	<b>7856.013</b>

#### Accessories:

Optimum locking function is only achieved with connection cable DK 7856.014, see page 204.



### Measurement module PSM

For power measurement of existing PSM or for new installations.

Suitable for for PSM busbar:  
DK 7856.010, DK 7856.020, DK 7856.008.

#### Note:

Detailed information, see PSM rail with measurement, page 202.

Packs of	Model No. DK
1	<b>7856.019</b>



### Overvoltage protection PSM

Is connected upstream of the busbar.

- Fine fuse
- Connection:
  - Socket Wago X-Com
  - Connector Wago X-Com

Overvoltage protection	Packs of	Model No. DK
With adaptor connector	1	<b>7856.170</b>

#### Note:

One adaptor is required for each infeed.

# RiCell Flex fuel cell system



## Application:

- Emergency power supplies, e.g. for mobile telecommunication base stations
- Indoor and outdoor use
- Temporary power supplies
- UPS applications
- High-MTBF applications
- Balancing energy supplies

## Material:

- Enclosure frame: Stainless steel 1.4301 (AISI 304)
- Door, side panels, roof: Aluminium AlMg3, powder-coated

**Colour:**  
RAL 7035

## Supply includes:

- Ready-to-connect fuel cell system including climate control. Hydrogen supply not included.
- 3 fuel cell modules fitted for 7.5 kW
- Controller

## Project planning:

- Higher level of cascading
- Different output voltages
- Housing for gas cylinders
- Primary power supply

Photo shows a configuration example with equipment not included in the scope of supply.

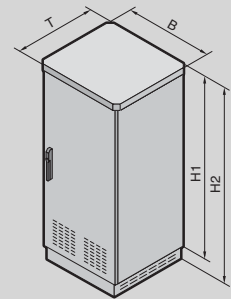

<b>Width (B) mm</b>	850
<b>Height (H1) mm</b>	2000
<b>Depth (T) mm</b>	850
Base/plinth height mm	100
Overall height (H2) mm	2100
<b>Model No. FC</b>	<b>1782.135</b>
<b>Fuel cell module</b>	
Power consumption	2000 watts
Maximum power output	2500 watts <sup>1)</sup>
Output voltage	–44.0 to –55.5 V DC
Noise generation	< 60 dB (A) at distance of 1 m
Weight	28 kg
<b>Hydrogen supply</b>	
Gas type	Hydrogen, purity 99.9%, class 3.0
Consumption	10 slpm (standard litres per minute) per kW
Typical autonomy time	Freely scalable with bottle batteries; 600 l (1 bundle), 200 bar hydrogen provides for more than 24 h autonomy at 6 kW full load
Input pressure	12.0 to 20.0 bar
<b>Ambient conditions</b>	
Temperature range	–33°C to +45°C
Relative humidity	5% to 95%, non-condensing
Height above mean sea level	–60 m to 2000 m; thereafter 5% power reduction per 1000 m
<b>Monitoring</b>	
Interfaces	Ethernet TCP/IP
Software	Web-based user interface with display for status messages, event log and parameters
Alarm outputs	4 floating contacts: "H2 low"; "Non-critical error"; "Serious error"; "FC in operation"

<sup>1)</sup> Begin of life (BOL).



# Climate control

## Cooling with ambient air

TopTherm fan-and-filter units .....	212
Rack-mounted fans/tangential fans .....	217
Fan systems .....	219
Air/air heat exchangers .....	226

## Cooling units

Thermoelectric cooler .....	232
Wall-mounted cooling units .....	233
Roof-mounted cooling units .....	244
Modular climate control concept .....	248

## Liquid cooling

Air/water heat exchangers .....	252
Cold Plate .....	262
Chillers for water .....	264

## IT cooling

Chillers for IT cooling .....	272
CRAC system .....	274
Aisle containment .....	278
Liquid Cooling Package .....	279

## CS Outdoor climate control

Air/air heat exchangers and cooling units for CS Toptec .....	286
Air/air heat exchangers and cooling units for CS modular enclosures .....	287

## Enclosure heaters

Enclosure heaters .....	289
-------------------------	-----

## Climate control accessories

Air routing .....	291
Control/regulation .....	293
Mounting accessories .....	296
Filter technology .....	299
General .....	302

## Generation “Blue e”

Save energy permanently with Rittal cooling units.

Savings of up to 45% energy consumption with the same cooling output (ideally 70% compared with a conventional Rittal TopTherm Plus cooling unit in field trials).







# Experts in climate control

As system providers, Rittal are the world's top suppliers of exceptionally effective, energy-saving and environmentally-friendly climate control solutions, precisely tailored to the customer's individual requirements.

## Your benefits

### Planning and engineering

- RiTherm climate calculation software for requirement-based dimensioning
- Rittal system consulting for optimised cost and energy efficiency

### Products

- Energy-saving enclosure climate control for all ambient conditions in the industrial sector
- Effective, application-oriented product solutions for machine and process cooling
- Efficient, cost-saving IT climate control concepts, from individual server enclosures through to high-MTBF data centres

### Service

- Contiguous global delivery and service network
- Global spare parts service
- Our own accredited laboratories for testing and simulation of climate conditions

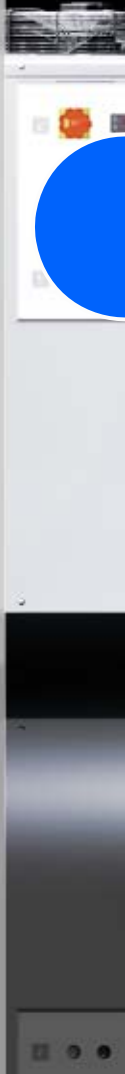



# Cooling with ambient air

## TopTherm fan-and-filter units

TopTherm fan-and-filter unit	20 – 66 m <sup>3</sup> /h	212
TopTherm fan-and-filter unit	105 – 120 m <sup>3</sup> /h	213
TopTherm fan-and-filter unit	180 – 250 m <sup>3</sup> /h	214
TopTherm fan-and-filter unit	550 – 770 m <sup>3</sup> /h	215
TopTherm fan-and-filter unit	900 m <sup>3</sup> /h	216
Conversion table old/new		216

## Rack-mounted climate control

Rack-mounted fan	320/480 m <sup>3</sup> /h	217
Vario rack-mounted fan	320/480 m <sup>3</sup> /h	218
Tangential fan	320 m <sup>3</sup> /h	218

## Fan systems

RTT roof-mounted fan	400/800 m <sup>3</sup> /h	219
Roof-mounted fan	360 m <sup>3</sup> /h	220
Roof-mounted fan for the office sector	1500 m <sup>3</sup> /h	220
Enclosure internal fan	160 m <sup>3</sup> /h	221
Fan mounting plate	180 m <sup>3</sup> /h	221
Mini-fan	21 m <sup>3</sup> /h	222
Fan expansion kit	108 – 184 m <sup>3</sup> /h	222
Fan roof, modular, two-piece	160/180 m <sup>3</sup> /h	223
Fan unit, active	160 m <sup>3</sup> /h	224
Fan mounting plate DC	1050 m <sup>3</sup> /h	224
Door-mounted fan	600 m <sup>3</sup> /h	225
Fan expansion kit		225

## Air/air heat exchangers

Wall-mounted	12/62 W/K	226
Wall-mounted with controller	17.5 – 90 W/K	227
Wall-mounted, railway-compatible version	27 – 98 W/K	228
Roof-mounted	66 W/K	229



# TopTherm fan-and-filter units



Climate control accessories Page 291 Software & services Page 333

**Colour:**  
RAL 7035

**Protection category:**  
See tables.

**Supply includes:**  
– Unit ready for installation  
– Filter mat

**Note:**  
For energy-efficient operation of the fan-and-filter units, we recommend using the enclosure internal thermostat SK 3110.000, the speed control SK 3120.200 or the digital thermostat with display SK 3114.200 (see accessories).

**Approvals:**  
Available on the Internet.

**Detailed drawing:**  
Available on the Internet.

**Performance diagrams:**  
Available on the Internet.

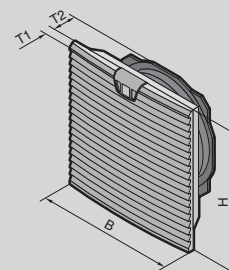

## Air throughput 20 – 66 m<sup>3</sup>/h

Model No. SK fan-and-filter unit	3237.100	3237.600	3237.110	3237.124	3238.100	3238.600	3238.110	3238.124	Page
<b>EMC version</b>	–	■	–	–	–	■	–	–	
Rated operating voltage V, Hz	230, 50/60		115, 50/60		24 (DC)		230, 50/60		
Dimensions mm	W (B) x H				148.5 x 148.5				
	D (T1)				16				
Max. installation depth mm	D (T2)				43				
	58.5								
<b>Air throughput, unimpeded air flow</b>	<b>20/25 m<sup>3</sup>/h</b>			<b>20 m<sup>3</sup>/h</b>	<b>55/66 m<sup>3</sup>/h</b>			<b>55 m<sup>3</sup>/h</b>	
Air throughput with outlet filter including standard filter mat	1 x SK 3237.200: <b>15/18 m<sup>3</sup>/h</b>				1 x SK 3238.200: <b>43/50 m<sup>3</sup>/h</b> 2 x SK 3238.200: <b>48/57 m<sup>3</sup>/h</b>				

Diagonal fan	Self-starting shaded pole motor		DC motor	Self-starting shaded pole motor		DC motor		
Rated current	0.065 A/ 0.052 A		0.12 A/ 0.10 A	0.125 A	0.12 A/ 0.11 A		0.24 A/ 0.22 A	0.23 A
Power consumption	11 W/9 W		3 W	19 W/18 W		5.5 W		
Pre-fuse	2 A							
Noise level	38/43 dB (A)			38 dB (A)	46/49 dB (A)		46 dB (A)	
Operating temperature range	–15°C to +55°C							
Storage temperature range	–30°C to +70°C							

### Protection category

Standard	IP 54	IP 54	IP 54	IP 54	IP 54	IP 54	IP 54	IP 54	
With hose-proof hood	IP 56	IP 56	IP 56	IP 56	IP 56	IP 56	IP 56	IP 56	

Accessories	Packs of	3237.200	–	3237.200	3237.200	3238.200	–	3238.200	3238.200	303
SK outlet filter	1	3237.200	–	3237.200	3237.200	3238.200	–	3238.200	3238.200	303
SK outlet filter – EMC	1	–	3237.060	–	–	–	3238.060	–	–	303
Spare filter mats	5	3321.700	3237.066	3321.700	3321.700	3238.066	3238.066	3322.700	3322.700	301
Fine filter mats	5	–	–	–	–	3238.055	3238.055	3238.055	3238.055	302
Hose-proof hood	1	3237.080	3237.080	3237.080	3237.080	3238.080	3238.080	3238.080	3238.080	303
Blanking cover	1	3237.020	3237.020	3237.020	3237.020	3238.020	3238.020	3238.020	3238.020	303
Enclosure internal thermostat	1	3110.000	3110.000	3110.000	3110.000	3110.000	3110.000	3110.000	3110.000	294
Digital temperature display/thermostat	1	3114.200	3114.200	3114.200	3114.200	3114.200	3114.200	3114.200	3114.200	293
Hygrostat	1	3118.000	3118.000	3118.000	3118.000	3118.000	3118.000	3118.000	3118.000	294
Speed control	1	3120.200	3120.200	3120.200	–	3120.200	3120.200	3120.200	–	295

Special voltages available on request. We reserve the right to make technical modifications.

# TopTherm fan-and-filter units

## Air throughput 105 – 120 m<sup>3</sup>/h

Model No. SK fan-and-filter unit	3239.100	3239.600	3239.110	3239.124	Page
<b>EMC version</b>	–	■	–	–	
Rated operating voltage V, Hz	230, 50/60		115, 50/60	24 (DC)	
Dimensions mm	W (B) x H 204 x 204				
	D (T1) 24				
Max. installation depth mm	D (T2) 90				
<b>Air throughput, unimpeded air flow</b>	<b>105/120 m<sup>3</sup>/h</b>			<b>105 m<sup>3</sup>/h</b>	
Air throughput with outlet filter including standard filter mat	1 x SK 3239.200: <b>87/100 m<sup>3</sup>/h</b> 2 x SK 3239.200: <b>93/108 m<sup>3</sup>/h</b> 1 x SK 3240.200: <b>98/111 m<sup>3</sup>/h</b>				

Diagonal fan	Self-starting shaded pole motor		DC motor	
Rated current	0.12 A/0.11 A		0.24 A/0.22 A	0.23 A
Power consumption	19 W/18 W		5.5 W	
Pre-fuse	2 A			
Noise level	46/49 dB (A)		46 dB (A)	
Operating temperature range	–15°C to +55°C			
Storage temperature range	–30°C to +70°C			

### Protection category

Standard	IP 54	IP 54	IP 54	IP 54	
With additional fine filter mat or hose-proof hood	IP 55	IP 55	IP 55	IP 55	
With hose-proof hood	IP 56	IP 56	IP 56	IP 56	

### Accessories

	Packs of					
SK outlet filter	1	3239.200	–	3239.200	3239.200	303
SK outlet filter – EMC	1	–	3239.060	–	–	303
Spare filter mats	5	3171.100	3239.066	3171.100	3171.100	301
Fine filter mats	5	3181.100	3181.100	3181.100	3181.100	302
Hose-proof hood	1	3239.080	3239.080	3239.080	3239.080	303
Blanking cover	1	3239.020	3239.020	3239.020	3239.020	303
Enclosure internal thermostat	1	3110.000	3110.000	3110.000	3110.000	294
Digital temperature display/thermostat	1	3114.200	3114.200	3114.200	3114.200	293
Hygrostat	1	3118.000	3118.000	3118.000	3118.000	294
Speed control	1	3120.200	3120.200	3120.200	3120.200	295

Special voltages available on request. We reserve the right to make technical modifications.



## Rittal Germany

RITTAL GmbH & Co. KG  
Postfach 1662 · D-35726 Herborn  
Phone: +49(0)2772 505-0  
Fax: +49(0)2772 505-2319  
E-mail: info@rittal.de · www.rittal.com

# TopTherm fan-and-filter units

## Air throughput 180 – 250 m<sup>3</sup>/h

Model No. SK fan-and-filter unit	3240.100	3240.600	3240.110	3240.124	3241.100	3241.600	3241.110	3241.124	Page
<b>EMC version</b>	–	■	–	–	–	■	–	–	
Rated operating voltage V, Hz	230, 50/60		115, 50/60	24 (DC)	230, 50/60		115, 50/60	24 (DC)	
Dimensions mm	W (B) x H		255 x 255						
	D (T1)		25						
Max. installation depth mm	D (T2)		107						
<b>Air throughput, unimpeded air flow</b>	<b>180/160 m<sup>3</sup>/h</b>			<b>180 m<sup>3</sup>/h</b>	<b>230/250 m<sup>3</sup>/h</b>			<b>230 m<sup>3</sup>/h</b>	
Air throughput with outlet filter including standard filter mat	1 x SK 3240.200: <b>138/115 m<sup>3</sup>/h</b> 2 x SK 3240.200: <b>165/140 m<sup>3</sup>/h</b> 1 x SK 3243.200: <b>165/140 m<sup>3</sup>/h</b>				1 x SK 3240.200: <b>183/195 m<sup>3</sup>/h</b> 2 x SK 3240.200: <b>203/230 m<sup>3</sup>/h</b> 1 x SK 3243.200: <b>203/230 m<sup>3</sup>/h</b>				

Diagonal fan	Self-starting shaded pole motor		DC motor	Self-starting shaded pole motor		DC motor		
Rated current	0.21 A/ 0.19 A		0.42 A/ 0.38 A	0.43 A	0.26 A/ 0.24 A		0.52 A/ 0.48 A	0.78 A
Power consumption	35 W/34 W			11 W	40 W/42 W			19 W
Pre-fuse	2 A		4 A	2 A	4 A		2 A	
Noise level	51/46 dB (A)			51 dB (A)	54/56 dB (A)			54 dB (A)
Operating temperature range	–30°C to +55°C							
Storage temperature range	–30°C to +70°C							

<b>Protection category</b>									
Standard	IP 54	IP 54	IP 54	IP 54	IP 54	IP 54	IP 54	IP 54	IP 54
With additional fine filter mat or hose-proof hood	IP 55	IP 55	IP 55	IP 55	IP 55	IP 55	IP 55	IP 55	IP 55
With hose-proof hood	IP 56	IP 56	IP 56	IP 56	IP 56	IP 56	IP 56	IP 56	IP 56

<b>Accessories</b>										
	Packs of									
SK outlet filter	1	3240.200	–	3240.200	3240.200	3240.200	–	3240.200	3240.200	303
SK outlet filter – EMC	1	–	3240.060	–	–	–	3240.060	–	–	303
Spare filter mats	5	3172.100	3240.066	3172.100	3172.100	3172.100	3240.066	3172.100	3172.100	301
Fine filter mats	5	3182.100	3182.100	3182.100	3182.100	3182.100	3182.100	3182.100	3182.100	302
Hose-proof hood	1	3240.080	3240.080	3240.080	3240.080	3240.080	3240.080	3240.080	3240.080	303
Blanking cover	1	3240.020	3240.020	3240.020	3240.020	3240.020	3240.020	3240.020	3240.020	303
Enclosure internal thermostat	1	3110.000	3110.000	3110.000	3110.000	3110.000	3110.000	3110.000	3110.000	294
Digital temperature display/thermostat	1	3114.200	3114.200	3114.200	3114.200	3114.200	3114.200	3114.200	3114.200	293
Hygrostat	1	3118.000	3118.000	3118.000	3118.000	3118.000	3118.000	3118.000	3118.000	294
Speed control	1	3120.200	3120.200	3120.200	–	3120.200	3120.200	3120.200	–	295

Special voltages available on request. We reserve the right to make technical modifications.



## Rittal Netherlands

RITTAL bv  
 Hengelder 56 · Postbus 246  
 6900 AE Zevenaar  
 Phone: +31 (0) 316 59 16 60  
 Fax: +31 (0) 316 52 51 45  
 E-mail: sales@rittal.nl · www.rittal.nl

# TopTherm fan-and-filter units

## Air throughput 550 – 770 m<sup>3</sup>/h

Model No. SK fan-and-filter unit	3243.100	3243.600	3243.110	3244.100	3244.600	3244.110	3244.140	Page
EMC version	–	■	–	–	■	–	–	
Rated operating voltage V, Hz	230, 50/60		115, 50/60	230, 50/60		115, 50/60		
Dimensions mm	W (B) x H		323 x 323					
	D (T1)		25					
Max. installation depth mm	D (T2)		118.5		130.5			
<b>Air throughput, unimpeded air flow</b>	<b>550/600 m<sup>3</sup>/h</b>			<b>700/770 m<sup>3</sup>/h</b>				
Air throughput with outlet filter including standard filter mat	1 x SK 3243.200: <b>440/490 m<sup>3</sup>/h</b> 2 x SK 3243.200: <b>510/560 m<sup>3</sup>/h</b>			1 x SK 3243.200: <b>544/610 m<sup>3</sup>/h</b> 2 x SK 3243.200: <b>630/690 m<sup>3</sup>/h</b>				

Diagonal fan	1~ capacitor motor					Rotary current motor		
Rated current	0.37 A/0.39 A		0.78 A/0.80 A	0.43 A/0.60 A		0.9 A/1.25 A	0.17 A/0.21 A	
Power consumption	70 W/87 W		75 W/90 W	95 W/135 W		100 W/145 W	93 W/140 W	
Pre-fuse	4 A		6 A	4 A		6 A	Motor circuit-breaker	
Noise level	59/61 dB (A)			65/66 dB (A)				
Operating temperature range	–30°C to +55°C							
Storage temperature range	–30°C to +70°C							

### Protection category

Standard	IP 54	IP 54	IP 54	IP 54	IP 54	IP 54	IP 54	
With additional fine filter mat or hose-proof hood	IP 55	IP 55	IP 55	IP 55	IP 55	IP 55	IP 55	
With hose-proof hood	IP 56	IP 56	IP 56	IP 56	IP 56	IP 56	IP 56	

### Accessories

	Packs of	3243.200	3243.600	3243.110	3244.100	3244.600	3244.110	3244.140	
SK outlet filter	1	3243.200	–	3243.200	3243.200	–	3243.200	3243.200	303
SK outlet filter – EMC	1	–	3243.060	–	–	3243.060	–	–	303
Spare filter mats	5	3173.100	3243.066	3173.100	3173.100	3243.066	3173.100	3173.100	301
Fine filter mats	5	3183.100	3183.100	3183.100	3183.100	3183.100	3183.100	3183.100	302
Hose-proof hood	1	3243.080	3243.080	3243.080	3243.080	3243.080	3243.080	3243.080	303
Blanking cover	1	3243.020	3243.020	3243.020	3243.020	3243.020	3243.020	3243.020	303
Enclosure internal thermostat	1	3110.000	3110.000	3110.000	3110.000	3110.000	3110.000	3110.000	294
Digital temperature display/ thermostat	1	3114.200	3114.200	3114.200	3114.200	3114.200	3114.200	3114.200	293
Hygrostat	1	3118.000	3118.000	3118.000	3118.000	3118.000	3118.000	3118.000	294
Speed control	1	3120.200	3120.200	3120.200	3120.200	3120.200	3120.200	3120.200	295

Special voltages available on request. We reserve the right to make technical modifications.



## Rittal India

RITTAL India Pvt. Ltd.  
Nos. 23 & 24, KIADB Industrial Area  
Veerapura · Doddaballapur-561 203  
Bengaluru Dist  
Phone: +91 80 2289 0700  
Fax: +91 80 2762 3343  
E-mail: [info@rittal-india.com](mailto:info@rittal-india.com)  
[www.rittal-india.com](http://www.rittal-india.com)

# TopTherm fan-and-filter units

Air throughput 900 m<sup>3</sup>/h, with EC technology

Model No. SK fan-and-filter unit	3245.500 <sup>1)</sup>	3245.600 <sup>1)</sup>	3245.510 <sup>1)</sup>	Page
<b>EMC version</b>	–	■	–	
Rated operating voltage V, Hz	230, 50/60		115, 50/60	
Dimensions mm	W (B) x H	323 x 323		
	D (T1)	25		
Max. installation depth mm	D (T2)	130,5		
<b>Air throughput, unimpeded air flow</b>	<b>900 m<sup>3</sup>/h</b>			
Air throughput with outlet filter including standard filter mat	1 x SK 3243.200: <b>680 m<sup>3</sup>/h</b> 2 x SK 3243.200: <b>820 m<sup>3</sup>/h</b>	1 x SK 3243.060: <b>680 m<sup>3</sup>/h</b> 2 x SK 3243.060: <b>820 m<sup>3</sup>/h</b>	1 x SK 3243.200: <b>680 m<sup>3</sup>/h</b> 2 x SK 3243.200: <b>820 m<sup>3</sup>/h</b>	

Diagonal fan	EC motor		
Rated current	1.25 A	2.5 A	
Power consumption	170 W		
Pre-fuse	4 A	6 A	
Noise level	72 dB (A)		
Operating temperature range	–30°C to +55°C		
Storage temperature range	–30°C to +70°C		

<b>Protection category</b>				
Standard	IP 51	IP 51	IP 51	
With additional fine filter mat	IP 52	IP 52	IP 52	
With hose-proof hood	IP 56	IP 56	IP 56	

<b>Accessories</b>		Packs of			
SK outlet filter	1	3243.200	–	3243.200	303
SK outlet filter – EMC	1	–	3243.060	–	303
Spare filter mats	5	3173.100	3243.066	3173.100	301
Fine filter mats	5	3183.100	3183.100	3183.100	302
Hose-proof hood	1	3245.080	3245.080	3245.080	303
Blanking cover	1	3243.020	3243.020	3243.020	303
Enclosure internal thermostat	1	3110.000	3110.000	3110.000	294
Digital temperature display/thermostat	1	3114.200	3114.200	3114.200	293
Hygrostat	1	3118.000	3118.000	3118.000	294
Speed control and monitoring for EC fan-and-filter units	1	3235.440 <sup>2)</sup>	3235.440 <sup>2)</sup>	3235.440 <sup>2)</sup>	294

<sup>1)</sup> 0 – 10 V input and tacho signal output

<sup>2)</sup> On request.

Special voltages available on request. We reserve the right to make technical modifications.

## Conversion table old/new

Output class	20/25 m <sup>3</sup> /h	55/66 m <sup>3</sup> /h	105/120 m <sup>3</sup> /h	180/160 m <sup>3</sup> /h	230/250 m <sup>3</sup> /h	550/600 m <sup>3</sup> /h	700/770 m <sup>3</sup> /h
Cut-out dimensions (old = new)	92 x 92	124 x 124	177 x 177	224 x 224		292 x 292	
24 V	<b>new</b>	<b>3237.124</b>	<b>3238.124</b>	<b>3239.124</b>	<b>3240.124</b>	<b>3241.124</b>	–
	old	3321.027	3322.027	3323.027	3324.027	3325.027	–
230 V	<b>new</b>	<b>3237.100</b>	<b>3238.100</b>	<b>3239.100</b>	<b>3240.100</b>	<b>3241.100</b>	<b>3243.100</b>
	old	3321.107	3322.107	3323.107	3324.107	3325.107	3326.107
115 V	<b>new</b>	<b>3237.110</b>	<b>3238.110</b>	<b>3239.110</b>	<b>3240.110</b>	<b>3241.110</b>	<b>3243.110</b>
	old	3321.117	3322.117	3323.117	3324.117	3325.117	3326.117
400 V	<b>new</b>	–	–	–	–	–	<b>3244.140</b>
	old	–	–	–	–	–	3327.147
EMC fan-and-filter unit, 230 V	<b>new</b>	<b>3237.600</b>	<b>3238.600</b>	<b>3239.600</b>	<b>3240.600</b>	<b>3241.600</b>	<b>3243.600</b>
	old	3321.607	3322.607	3323.607	3324.607	3325.607	3326.607
Outlet filter	<b>new</b>	<b>3237.200</b>	<b>3238.200</b>	<b>3239.200</b>	<b>3240.200</b>	<b>3241.200</b>	<b>3243.200</b>
	old	3321.207	3322.207	3323.207	3324.207	3325.207	3326.207
EMC outlet filter	<b>new</b>	<b>3237.060</b>	<b>3238.060</b>	<b>3239.060</b>	<b>3240.060</b>	<b>3241.060</b>	<b>3243.060</b>
	old	3321.267	3322.267	3323.267	3324.267	3325.267	3326.267
Hose-proof hood	<b>new</b>	<b>3237.080</b>	<b>3238.080</b>	<b>3239.080</b>	<b>3240.080</b>	<b>3241.080</b>	<b>3243.080</b>
	old	3321.800	3322.800	3323.800	3324.800	3325.800	3326.800
Blanking cover	<b>new</b>	<b>3237.020</b>	<b>3238.020</b>	<b>3239.020</b>	<b>3240.020</b>	<b>3241.020</b>	<b>3243.020</b>
	old	–	–	–	–	–	–
Standard filter mat (IP 54)	<b>new</b>	<b>3321.700</b>	<b>3322.700</b>	<b>3171.100</b>	<b>3172.100</b>	<b>3173.100</b>	<b>3173.100</b>
	old	3321.700	3322.700	3171.100	3172.100	3173.100	3327.700
Fine filter mat (IP 55)	<b>new</b>	–	<b>3238.055</b>	<b>3181.100</b>	<b>3182.100</b>	<b>3183.100</b>	<b>3183.100</b>
	old	–	–	3181.100	3182.100	3183.100	3183.100



# Rack-mounted fans/tangential fans for 482.6 mm (19")



Climate control accessories Page 291 Software & services Page 333

## Supply includes:

- Fully wired unit ready for connection
- Clamping strip and assembly parts (for rack-mounted fan/ Vario rack-mounted fan)
- Filter mat (for tangential fan)

## Guide frame supply includes:

- Guide frame
- Connector and fitted connection cable (3 m)
- Mounting bracket for optional attachment to the 482.6 mm (19") system
- Assembly parts



## Also required:

Order a guide frame according to the application (only for Vario rack-mounted fan)

## Approvals:

Available on the Internet.

## Detailed drawing:

Available on the Internet.

## Performance diagrams:

Available on the Internet.

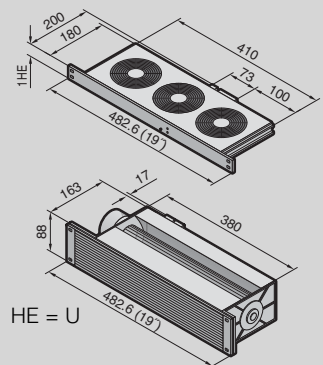

## Rack-mounted fan, air throughput 320/480 m<sup>3</sup>/h

Model No. SK	3340.024 <sup>1)</sup>	3340.115 <sup>1)</sup>	3340.230	3341.024 <sup>1)</sup>	3341.115	3341.230	Page
2 fans, distance between axes 85 mm	■						
3 fans, distance between axes 85 mm				■			
Rated operating voltage V, Hz	24 (DC)	115 (AC), 50/60	230 (AC), 50/60	24 (DC)	115 (AC), 50/60	230 (AC), 50/60	
Dimensions mm W x H x D	482.6 (19") x 44 (1 U) x 200						
<b>Air throughput, unimpeded air flow</b>	<b>320 m<sup>3</sup>/h</b>			<b>480 m<sup>3</sup>/h</b>			

Rated current max.	0.49 A	0.46 A/0.46 A	0.24 A/0.22 A	0.74 A	0.69 A/0.69 A	0.36 A/0.33 A	
Pre-fuse T	6.0 A						
Operating temperature range	-10°C to +55°C						
Noise level	51 dB (A)	52 dB (A)	51 dB (A)		52 dB (A)	51 dB (A)	

### Accessories

Digital temperature display/thermostat	3114.200	3114.200	3114.200	3114.200	3114.200	3114.200	293
Enclosure internal thermostat	3110.000	3110.000	3110.000	3110.000	3110.000	3110.000	294
Speed control	-	3120.200	3120.200	-	3120.200	3120.200	295

Model No. SK	3342.024 <sup>1)</sup>	3342.115 <sup>1)</sup>	3342.230	3342.500 <sup>2)3)</sup>	Page
3 fans, distance between axes 105 mm	■				
Rated operating voltage V, Hz	24 (DC)	115 (AC), 50/60	230 (AC), 50/60	24 (DC) 115 - 230 (AC)	
Dimensions mm W x H x D	482.6 (19") x 44 (1 U) x 200				
<b>Air throughput, unimpeded air flow</b>	<b>480 m<sup>3</sup>/h</b>				

Rated current max.	0.74 A	0.69 A/0.69 A	0.36 A/0.33 A	0.85 A	
Pre-fuse T	6.0 A				
Operating temperature range	-10°C to +55°C				
Noise level	51 dB (A)	52 dB (A)	51 dB (A)		

### Accessories

Digital temperature display/thermostat	3114.200	3114.200	3114.200	3114.200	293
Enclosure internal thermostat	3110.000	3110.000	3110.000	3110.000	294
Speed control	-	3120.200	3120.200	-	295

<sup>1)</sup> Extended delivery times. <sup>2)</sup> Rack-mounted fan for metric mounting angles available on request. <sup>3)</sup> Version with monitoring.

# Rack-mounted fans/tangential fans for 482.6 mm (19")

## Vario rack-mounted fan, air throughput 320/480 m<sup>3</sup>/h

Model No. SK	3350.024 <sup>1)</sup>	3350.115 <sup>1)</sup>	3350.230	3351.024 <sup>1)</sup>	3351.115	3351.230	Page
2 fans, distance between axes 85 mm	■			-			
3 fans, distance between axes 85 mm	-			■			
Rated operating voltage V, Hz	24 (DC)	115 (AC), 50/60	230 (AC), 50/60	24 (DC)	115 (AC), 50/60	230 (AC), 50/60	
Dimensions mm W x H x D	482.6 (19") x 44 (1 U) x 200						
<b>Air throughput, unimpeded air flow</b>	<b>320 m<sup>3</sup>/h</b>			<b>480 m<sup>3</sup>/h</b>			

Rated current max.	0.49 A	0.46 A/0.46 A	0.24 A/0.22 A	0.74 A	0.69 A/0.69 A	0.36 A/0.33 A	
Pre-fuse T	6.0 A						
Operating temperature range	-10°C to +55°C						
Noise level	51 dB (A)	52 dB (A)	51 dB (A)		52 dB (A)	51 dB (A)	

### Accessories

Guide frame	<b>3356.100</b>	<b>3355.100</b>	<b>3355.100</b>	<b>3356.100</b>	<b>3355.100</b>	<b>3355.100</b>	-
Digital temperature display/thermostat	3114.200	3114.200	3114.200	3114.200	3114.200	3114.200	293
Enclosure internal thermostat	3110.000	3110.000	3110.000	3110.000	3110.000	3110.000	294
Speed control	-	3120.200	3120.200	-	3120.200	3120.200	295

Model No. SK	3352.024 <sup>1)</sup>	3352.115 <sup>1)</sup>	3352.230	3352.500 <sup>1)2)</sup>	Page
3 fans, distance between axes 105 mm	■				
Rated operating voltage V, Hz	24 (DC)	115 (AC), 50/60	230 (AC), 50/60	24 (DC), 115 – 230 (AC)	
Dimensions mm W x H x D	482.6 (19") x 44 (1 U) x 200				
<b>Air throughput, unimpeded air flow</b>	<b>480 m<sup>3</sup>/h</b>				

Rated current max.	0.74 A	0.69 A/0.69 A	0.36 A/0.33 A	0.85 A	
Pre-fuse T	6.0 A				
Operating temperature range	-10°C to +55°C				
Noise level	51 dB (A)	52 dB (A)	51 dB (A)		

### Accessories

Guide frame	<b>3356.100</b>	<b>3355.100</b>	<b>3355.100</b>	<b>3357.100<sup>1)</sup></b>	-
Digital temperature display/thermostat	3114.200	3114.200	3114.200	3114.200	293
Enclosure internal thermostat	3110.000	3110.000	3110.000	3110.000	294
Speed control	3120.200	3120.200	3120.200	-	295

<sup>1)</sup> Extended delivery times.

<sup>2)</sup> Version with monitoring

## Tangential fans, air throughput 320 m<sup>3</sup>/h

Model No. SK	3145.000	3144.000	Page
Rated operating voltage V, Hz	115, 50/60	230, 50/60	
Dimensions mm W x H x D	482.6 (19") x 88 (2 U) x 158		
<b>Air throughput, unimpeded air flow</b>	<b>320 m<sup>3</sup>/h</b>		

Rated current max.	0.32 A	0.16 A	
Power	37 W		
Noise level	52 dB (A)		
Speed	2245 min <sup>-1</sup>		
Operating temperature range	-10°C to +55°C		
Maximum static pressure difference	65 – 70 Pa		

### Accessories

	Packs of			
Digital temperature display/thermostat	1	3114.200	3114.200	293
Enclosure internal thermostat	1	3110.000	3110.000	294
Filter mats	5	3177.000	3177.000	299
Front outlet grille 2 U	1	3176.000	3176.000	304
Roof vent	1	3148.007	3148.007	220
Speed control	1	3120.200	3120.200	295

Special voltages available on request. We reserve the right to make technical modifications.

## RTT roof-mounted fan and vent attachment

### for TS

The active roof-mounted fan and the passive vent attachment (TS 8801.380) integrate perfectly into the system-wide mounting concept of the Rittal TopTherm platform. They fit precisely onto the cut-outs of the small and medium performance category of TopTherm roof-mounted cooling units.

Of course, they may also be mounted on any sufficiently large roof surface.

TS roof plates with prepared mounting cut-outs are additionally available.

### Roof-mounted fan supply includes:

- Unit ready for connection with built-in radial fan
- Sealing and assembly parts

### Vent attachment TS:

see page 296.

### Protection category:

IP 43 to IEC 60 529

### Detailed drawings:

Available on the Internet.

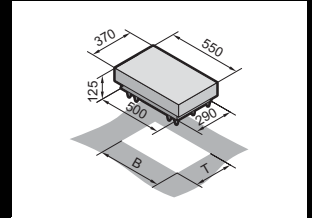

### Air throughput 400 m³/h

Model No. SK	3149.410	3149.420	3149.440	Page
Rated operating voltage V, Hz	115, 50/60	230, 50/60	400, 3~, 50/60 460, 3~, 60	
<b>Air throughput, unimpeded air flow</b>	<b>400 m³/h</b>			
Required mounting cut-out W (B) x D (T) mm	475 x 260			
Power consumption of fan	120 W/170 W		95 W/140 W	
Rated current of fan	1.1/1.6 A	0.5/0.88 A	0.35/0.35 A	
Operating temperature range	-10°C to +55°C			
Noise level	68/69 dB (A)			
Weight	10 kg			
Colour	RAL 7035			
<b>Accessories</b>				
Roof plate 800 x 600 mm for TS 8 with cut-out	8801.320	8801.320	8801.320	296
Roof plate 1200 x 600 mm for TS 8 with cut-out	–	–	–	296
Digital temperature display/thermostat	3114.200	3114.200	–	293
Speed control	3120.200	3120.200	–	295

### Air throughput 800 m³/h

Model No. SK	3149.810	3149.820	3149.840	8801.380	Page
Rated operating voltage V, Hz	115, 50/60	230, 50/60	400, 3~, 50/60 460, 3~, 60	Vent attachment	
<b>Air throughput, unimpeded air flow</b>	<b>800 m³/h</b>			<b>Without motor</b>	
Required mounting cut-out W (B) x D (T) mm	475 x 260			490 x 390	
Power consumption of fan	170 W/225 W		180 W/310 W	–	
Rated current of fan	1.5/2.2 A	0.75/1.1 A	0.35/0.55 A	–	
Operating temperature range	-10°C to +55°C			–	
Noise level	69/70 dB (A)			–	
Weight	11 kg			6 kg	
Colour	RAL 7035				
<b>Accessories</b>					
Roof plate 600 x 600 mm for TS 8 with cut-out	8801.300	8801.300	8801.300	8801.310	296
Roof plate 800 x 600 mm for TS 8 with cut-out	8801.320	8801.320	8801.320	8801.330	296
Roof plate 1200 x 600 mm for TS 8 with cut-out	–	–	–	8801.350	296
Digital temperature display/thermostat	3114.200	3114.200	–	–	293
Speed control	3120.200	3120.200	–	–	295

# Fan systems

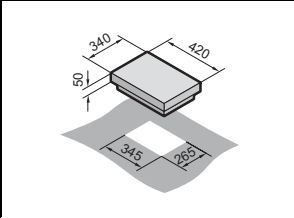

## Roof-mounted fan, roof vent

- The roof-mounted fan is easily installed using 6 screws. The sealing tape supplied can be used to seal it against the enclosure.
- The assembly screws are invisible from the outside.
- The roof-mounted fan casing has a large air outlet surface and labyrinth air ducting.

### Protection category:

IP 43 to IEC 60 529. Via additional installation of the filter holder with filter mat SK 3175.000, a protection category of IP 44 is achieved with roof vent SK 3148.007.

### Supply includes:

- Unit ready for connection with built-in radial fan
- Sealing and assembly parts
- Connection cable (3 m)
- Drilling template



### Accessories:

Filter holder, see page 304.

### Detailed drawings:

Available on the Internet.

Model No. SK	3149.007	3169.007	3148.007
Rated operating voltage V, Hz	230, 50/60	115, 50/60	Without fan motor
<b>Air throughput</b>	<b>360 m³/h</b>		
Rated current max.	0.2 A	0.55 A	
Power consumption	42 W	65 W	
Operating temperature range	-10°C to +60°C		
Noise level	53 dB (A)		
Weight	7.8 kg		
Colour	RAL 7035, textured enamel		

Special voltages available on request. We reserve the right to make technical modifications.

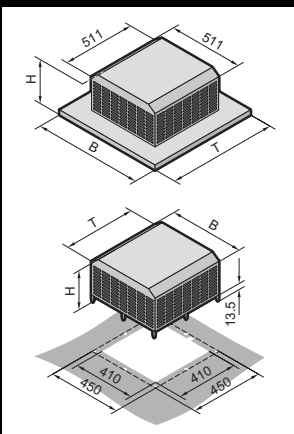

## Roof-mounted fan for TS in the office sector

This new roof ventilation concept offers a wealth of performance, assembly and cost benefits associated with the use of integrated ventilation systems. This roof-mounted fan may be ordered with and without a roof plate. Another outstanding feature is the enormous volumetric flow in proportion to exceptionally low noise levels, making it ideal for use in sensitive office areas.

### Technical specifications:

- Fitted onto a roof plate based on TS.
- Easy assembly; mounting cut-outs have been provided.
- Radial fan.

### Supply includes:

- Fully wired ready for connection
- Assembly parts.

### Detailed drawings:

Available on the Internet.

Model No. SK	3164.610	3164.620	3164.115	3164.230	Page
Rated operating voltage V, Hz	115, 50/60	230, 50/60	115, 50/60	230, 50/60	
<b>Air throughput, unimpeded air flow</b>	<b>1500 m³/h<sup>1)</sup></b>				
Design	with roof plate		without roof plate		
Dimensions mm	W (B) H D (T)	800 240 800	511 227 511		
Power consumption	68 W/81 W				
Rated current	0.6 A/0.7 A	0.3 A/0.35 A	0.6 A/0.7 A	0.3 A/0.35 A	
Noise level	40 dB (A)				
Operating temperature range	+20°C to +55°C				
Colour	RAL 7035				

### Accessories

	7109.035	7109.035	7109.035	7109.035	293
Temperature indicator in 1 U patch panel	7109.035	7109.035	7109.035	7109.035	293
Digital temperature display/thermostat	3114.200	3114.200	3114.200	3114.200	293
Enclosure internal thermostat	3110.000	3110.000	3110.000	3110.000	294

<sup>1)</sup> 800 m³/h at 40 Pa counterpressure using two integrated louvres, type DK 7825.801, in the enclosure base/plinth. Special voltages available on request. We reserve the right to make technical modifications.

## Enclosure internal fan

### for TS

To prevent hot-spots and support the air routing of active enclosure climate control components. Adjustable in two axes. Attached to the TS 8 frame section. Several fans may be cascaded using the quick-release clamping strip.

#### Supply includes:

- Complete unit with radial fan ready for connection
- Snap-on pivot device
- Assembly parts

Air throughput (unimpeded air flow)	Power consumption W	Rated current A	Rated voltage V, Hz	Model No. SK
160 m <sup>3</sup> /h	19.0/18.0	0.12/0.11	230, 50/60	<b>3108.100</b>
160 m <sup>3</sup> /h	19.0/18.0	0.24/0.23	115, 50/60	<b>3108.115</b>
160 m <sup>3</sup> /h	3.5	0.15	24 V (DC)	<b>3108.024</b>

#### Detailed drawings:

Available on the Internet.



## Fan mounting plate

### for TS

The fan mounting plate may be retro-fitted in all TS 8 network enclosures from above. The plate is mounted at the front of the enclosure, whilst the rear section is left free for cable entry. A rubber cable clamp strip is supplied loose for optional sealing at the rear.

The following combinations are also possible:

- Solid roof plate raised with 20 or 50 mm roof spacers.
- Roof plate for cable entry raised with 20 or 50 mm roof spacers.
- Vented roof plate for cable entry.

In conjunction with the large swing frame, usage is only possible from an enclosure depth of 800 mm, in conjunction with a roof plate for cable entry from 1000 mm.

#### Note:

- Not suitable for crane transportation
- Not suitable for combination with 482.6 mm (19") mounting frame

#### Technical specifications for one fan:

- Rated operating voltage: 230 V
- Power consumption: 15/14 W at 50/60 Hz
- Air throughput (unimpeded air flow): 160/180 m<sup>3</sup>/h, 50/60 Hz
- Operating temperature range: –10°C to +55°C

#### Technical specifications of thermostat:

- Rated operating voltage: 250 V
- Operating temperature range: +5°C to +55°C

#### Colour:

RAL 7035

#### Supply includes:

- 2 fans
- 2/4 cut-outs to extend to 4/6 fans
- Thermostat
- Foam rubber cable clamp strip
- Thermostat and fan fully wired to connection cable (3.5 m).

For enclosures		Number of fans	Max. number of fans	Model No. DK
Width mm	Depth mm			
600	600	2	4	<b>7966.035</b>
600	800	2	6	<b>7968.035</b>
	1000			
	1200			
800	600	2	6	<b>7986.035</b>
800	800	2	6	<b>7988.035</b>
	1000			
	1200			

The air throughput can be increased with the fan expansion kit DK 7980.000.



#### Accessories:

- Fan extension kit, see page 222.
- Self-adhesive foam cable clamp strip SZ 2573.000 for sealing at the sides and targeted air routing when bayed, see page 513.

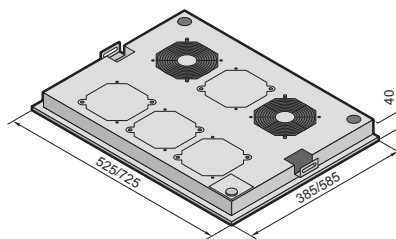

# Fan systems



## Mini-fan

Compact DC fan for enclosure and component cooling in enclosures.

### Technical specifications:

- Rated operating voltage: 24 V (DC)
- Power consumption: 1 W
- Air throughput (unimpeded air flow): 21 m<sup>3</sup>/h
- Noise level (unimpeded air flow): 20 dB (A)
- Operating temperature range: -20°C to +70°C

Dimensions W x H x D mm	Packs of	Model No. SK
60 x 60 x 25.4	1	<b>3236.124</b>

### Supply includes:

- Fans
- Assembly screws
- Contact hazard protection



## Fan expansion kit

For retro-fitting various fan units or to supplement the fan mounting plate and modular fan roof.

### Technical specifications DK 7980.000:

- Rated operating voltage: 230 V~
- Power consumption: 15/14 W at 50/60 Hz
- Air throughput (unimpeded air flow): 160/180 m<sup>3</sup>/h, 50/60 Hz
- Noise level (unimpeded air flow): 37 dB (A)
- Operating temperature range: -10°C to +55°C

### Technical specifications DK 7980.100:

- Rated operating voltage: 230 V~
- Power consumption: 14/12 W at 50/60 Hz
- Air throughput (unimpeded air flow): 108/120 m<sup>3</sup>/h, 50/60 Hz
- Noise level (unimpeded air flow): 34 dB (A)
- Operating temperature range: -20°C to +70°C

### Technical specifications DK 7980.148:

- Rated operating voltage: 48 V (DC)
- Power consumption: 7.7 W
- Air throughput (unimpeded air flow): 184 m<sup>3</sup>/h
- Noise level (unimpeded air flow): 43 dB (A)
- Operating temperature range: -20°C to +70°C

Dimensions W x H x D mm	Packs of	Model No. DK
119 x 119 x 38	1 set	<b>7980.000</b>
119 x 119 x 25	1 set	<b>7980.100</b>
119 x 119 x 38	1 set	<b>7980.148</b>

### Supply includes:

- Fans
- Assembly parts
- Connection cable (0.61 m)



## Cover plates for fan panels

### for FlatBox

To cover unused fan panels when using fans in the FlatBox.

### Material:

Sheet steel

### Surface finish:

Powder-coated

### Colour:

RAL 7035

### Supply includes:

Assembly parts.

Packs of	Model No. DK
6	<b>7507.760</b>

## Fan roof, modular, two-piece for TS

The modular roof plate consists of individual components and can be configured for enclosure ventilation in various ways.

### The modules:

#### Roof plate, two-piece with cut-out

For fan mounting and cable entry at the rear via a sliding angular bracket with rubber cable clamp strip. Replaces the existing roof plate. The two-piece design allows convenient retrofitting of cables at any time.

#### Cover plate

To cover the cut-out, optionally solid or vented options. The top-mounted cover plate may be raised for extra air throughput using the supplied spacers.

#### Fan insert

For active ventilation:

A fully pre-wired fan tray including 2.5 m connection cable, with two fan motors and additional cut-outs. The air throughput may be increased with a fan expansion kit.

### Material:

Sheet steel

### Surface finish:

Spray-finished

### Colour:

RAL 7035

### Technical specifications for one fan:

- Rated operating voltage: 230 V
- Power consumption: 15/14 W at 50/60 Hz
- Air throughput (unimpeded air flow): 160/180 m<sup>3</sup>/h at 50/60 Hz
- Temperature range: -10°C to +55°C

### Detailed drawing:

Available on the Internet.



### Accessories:

- Fan expansion kit DK 7980.000, see page 222.
- Enclosure internal thermostat SK 3110.000, see page 294.
- Speed control SK 3120.200, see page 295.

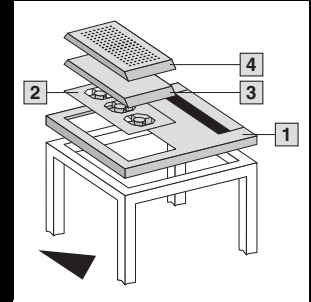

### Roof plate TS with cut-out

For enclosures		Model No. DK
Width mm	Depth mm	<b>1</b>
600	600	<b>7826.366</b>
600	800	<b>7826.368</b>
600	1000	<b>7826.360</b>
800	600	<b>7826.486</b>
800	800	<b>7826.488</b>
800	1000	<b>7826.480</b>

### Fan insert

For enclosures		Model No. DK	Fan insert	
Width mm	Depth mm	<b>2</b>	Fans pre-wired	Maximum no. of fans
600	600	<b>2102.320</b>	2	2
600	800	<b>2102.490</b>	2	6
600	1000	<b>2102.490</b>	2	6
800	600	<b>7885.000</b>	2	3
800	800	<b>7886.000</b>	2	8
800	1000	<b>7886.000</b>	2	8

### Roof plate, solid

For enclosures		Model No. DK
Width mm	Depth mm	<b>3</b>
600	600	<b>2102.180<sup>1)</sup></b>
600	800	<b>2102.190<sup>1)</sup></b>
600	1000	<b>2102.190<sup>1)</sup></b>
800	600	<b>7885.100</b>
800	800	<b>7886.100</b>
800	1000	<b>7886.100</b>

### Roof plate, vented

For enclosures		Model No. DK
Width mm	Depth mm	<b>4</b>
600	600	<b>2102.400</b>
600	800	<b>2102.410</b>
600	1000	<b>2102.410</b>
800	600	<b>7885.200</b>
800	800	<b>7886.200</b>
800	1000	<b>7886.200</b>

<sup>1)</sup> Extended delivery times.

# Fan systems

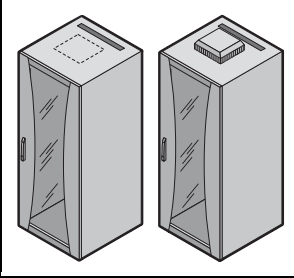

## Fan unit, active

### for TE

For active ventilation of the TE 7000. The fan unit is installed in the prepunched cut-out. An additional fan may optionally be integrated.

#### Supply includes:

- Fan unit
- Assembly parts
- 2 fans
- 1 thermostat
- Open connection cable

#### Technical specifications for one fan:

Fan extension kit, DK 7980.000, see page 222.

#### Technical specifications of thermostat:

- Rated operating voltage: 250 V
- Temperature range: +5°C to +55°C

For enclosures W x D mm	Number of pre-wired fans	Possible number of fans	Model No. TE
All sizes	2	3	<b>7000.670</b>

#### Note:

Connection via distributor box or country-specific connector.



#### Accessories:

Fan expansion kit, see page 222.

## Active kit

### for TE

consisting of fan unit including thermostat, complete, wired ready for connection, socket strip (DK 7000.630) for up to 8 earthing pin plugs, version D and connection cable (DK 7200.210).

Packs of	Model No. DK
1 set	<b>7000.680</b>



## Fan mounting plate DC

### for TS

#### Exceptionally low-noise thanks to FCS speed control, fully fitted

Suitable for TS 8 enclosures with a raised roof (> 20 mm) or TS 8 roof plate, vented. The fan mounting plate may be used as an alternative to fan mounting plate 7988.035. It is installed from above. Cable entry is prepared in the rear section of the plate. Not suitable for combination with 482.6 mm (19") mounting frame.

#### Advantages of the DC fan mounting plate with FCS technology:

- Exceptionally low-noise thanks to speed control.
- All fans are individually monitored for failure.
- High air throughput thanks to DC technology (unimpeded air flow  $6 \times 175 \text{ m}^3/\text{h} = 1050 \text{ m}^3/\text{h}$ ).
- EMC compatibility.
- Temperature monitoring and control.
- High level of safety (low safety voltage with 24 V DC power supply).
- Visual and acoustic alarm messages, plus relay alarm output.
- Freely selectable installation location for the FCS control unit (included with the supply of the fan mounting plate, in 482.6 mm (19") with 7320.440).
- Suitable for international use, thanks to wide-range power supply 100 – 240 V AC and socket to IEC 320.
- Pre-configured.
- Network-compatible via CMC-TC (all relevant data such as temperature etc. is displayed in the web browser, or alarms are sent in the form of an SNMP trap).

For enclosures width mm	For enclosures depth mm	Number of DC fans	Model No. DK
800	800 900 1000	6	<b>7858.488</b>

#### Technical specifications:

- Rated voltage of power supply: 100 – 240 V AC, 50/60 Hz
- Power pack rated current: max. 1.5 A
- Secondary range of power supply: 24 V DC, 3 A
- Temperature range: +5°C to +40°C
- Total air throughput (unimpeded air flow):  $6 \times 175 \text{ m}^3/\text{h} = 1050 \text{ m}^3/\text{h}$

#### Technical specifications for one fan:

- Rated voltage: 24 V DC
- Rated current: max. 0.3 A
- Air throughput (unimpeded air flow):  $175 \text{ m}^3/\text{h}$
- Speed: 2650 rpm
- Noise level: up to 45 dB (A) at maximum speed activation



#### Also required:

Connection cable 230/115 V. Example D version, Model No. DK 7200.210, see page 585.



#### Accessories:

1 U mounting unit, Model No. DK 7320.440, see page 586.

#### Note:

For more information on the Fan Control System (FCS) system, see page 587.



## Door-mounted fan for server enclosures TS, TE

### Specifically for installing in perforated doors.

Given the growing packaging density in data communications and network enclosures, active, direct ventilation of the enclosure is essential. The door-mounted fan, which is attached to the rear or front door, supports horizontal air routing via the servers and therefore facilitates faster heat dissipation from active components.

### Technical specifications:

- Standard assembly with two fans.
- Air throughput, unimpeded air flow 600 m<sup>3</sup>/h.
- By adding two fan expansion kits, the air throughput is increased to 1200 m<sup>3</sup>/h.
- The direction of air flow is easily reversed by rotating the fan.
- Several units may be positioned in a cascade arrangement.
- Simple mounting on the tubular door frame.

### Supply includes:

- Fully wired ready for connection
- Connection cable 2.5 m
- Assembly parts



### Accessories:

Fan expansion kit, see page 225.

### Note:

- Only for mounting on the tubular door frame!
- Door configuration for installation in 2 and 4-door ISP racks available on request.

### Detailed drawings:

Available on the Internet.

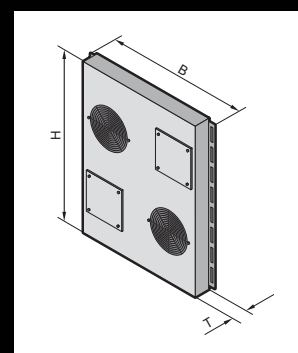

### For doors with width 600 mm

Model No. SK	3165.624 <sup>1)</sup>	3165.648 <sup>1)</sup>	3165.615 <sup>1)</sup>	3165.630 <sup>1)</sup>	Page
Rated operating voltage V, Hz	24 (DC)	48 (DC)	115, 50/60	230, 50/60	
<b>Air throughput (unimpeded air flow)</b>	<b>600 m<sup>3</sup>/h</b>				
Power consumption for two fans	40 W	48 W	70 W/64 W	70 W/70 W	
Rated current of fan	1.5 A	1.0 A	0.76 A/0.72 A	0.38 A/0.36 A	
Dimensions mm	W (B) 493 H 606 D (T) 64,5				
Noise level	55 dB (A)				
Temperature range	+20°C to +55°C				
Colour	RAL 7035				

### Accessories

Digital temperature display/thermostat	3114.200	3114.200	3114.200	3114.200	293
Enclosure internal thermostat	3110.000	3110.000	3110.000	3110.000	294

### For doors with width 800 mm

Model No. SK	3165.824 <sup>1)</sup>	3165.848 <sup>1)</sup>	3165.815 <sup>1)</sup>	3165.830 <sup>1)</sup>	Page
Rated operating voltage V, Hz	24 (DC)	48 (DC)	115, 50/60	230, 50/60	
<b>Air throughput (unimpeded air flow)</b>	<b>600 m<sup>3</sup>/h</b>				
Power consumption for two fans	40 W	48 W	70 W/64 W	70 W/70 W	
Rated current of fan	1.5 A	1.0 A	0.76 A/0.72 A	0.38 A/0.36 A	
Dimensions mm	W (B) 693 H 606 D (T) 64,5				
For doors with width (mm)	800				
Noise level	55 dB (A)				
Temperature range	+20°C to +55°C				
Colour	RAL 7035				

### Accessories

Digital temperature display/thermostat	3114.200	3114.200	3114.200	3114.200	293
Enclosure internal thermostat	3110.000	3110.000	3110.000	3110.000	294

<sup>1)</sup> Delivery times on request.

Special voltages available on request. We reserve the right to make technical modifications.

## Fan expansion kit

### for door-mounted fan

To increase the air throughput of the door-mounted fan.

To fit door-mounted fan	Model No. SK
SK 3165.624, SK 3165.824	<b>3165.024</b>
SK 3165.648, SK 3165.848	<b>3165.048</b>
SK 3165.615, SK 3165.815	<b>3165.115</b>
SK 3165.630, SK 3165.830	<b>3165.230</b>



# Air/air heat exchangers



Climate control accessories Page 291 Software & services Page 333

**Colour:**  
RAL 7035

**Protection category:**  
Internal circuit IP 54  
to IEC 60 529

**Supply includes:**  
Complete unit ready for connection.

**Note:**  
For precise temperature control inside the enclosure, we recommend the digital temperature indicator/thermostat SK 3114.200, the enclosure internal thermostat SK 3110.000 or the speed control SK 3120.200.

**Approvals:**  
Available on the Internet.

**Detailed drawing:**  
Available on the Internet.

**Performance diagrams:**  
Available on the Internet.

## Wall-mounted

Model No. SK	3125.800	3129.800	Page
Rated operating voltage V, Hz	230, 1~, 50/60		
Dimensions mm	W 200 H 400 D 146	400 1360 110	
<b>Specific thermal output</b>	<b>12 W/K</b>	<b>62 W/K</b>	
Max. rated current per fan	0.11 A/0.13 A	0.45 A/0.55 A	
Pre-fuse T	2.0 A		
Output per fan	25 W/30 W	100 W/130 W	
Operating temperature range	-5°C to +55°C		
Air throughput of fans (unimpeded air flow)	External circuit 265 m³/h / 315 m³/h Internal circuit 265 m³/h / 315 m³/h	860 m³/h / 900 m³/h 860 m³/h / 900 m³/h	
Type of connection	Connection cable		
Weight	8 kg	30 kg	
<b>Accessories</b>	Packs of		
Enclosure internal thermostat	1 3110.000	3110.000	294
Digital temperature display/thermostat	1 3114.200	3114.200	293
Speed control	1 3120.200	3120.200	295

Special voltages available on request. We reserve the right to make technical modifications.

# Air/air heat exchangers



Climate control accessories Page 291 Software & services Page 333

**Colour:**  
RAL 7035

**Protection category:**  
Internal circuit IP 54  
to IEC 60 529

**Supply includes:**  
– Complete unit ready for connection  
– Plug-in terminal strip

– With controller and digital temperature display  
– Floating fault signal contact in case of overtemperature

**Approvals:**  
Available on the Internet.

**Detailed drawing:**  
Available on the Internet.

**Performance diagrams:**  
Available on the Internet.

## Wall-mounted with controller, 17.5 – 45 W/K

Model No. SK	3126.100	3126.115	3127.100	3127.115	3128.100	3128.115	Page
Rated operating voltage V, Hz	230, 1~, 50/60	115, 1~, 50/60	230, 1~, 50/60	115, 1~, 50/60	230, 1~, 50/60	115, 1~, 50/60	
Dimensions mm	W x H x D 280 x 550 x 150		400 x 950 x 205				
<b>Specific thermal output</b>	<b>17.5 W/K</b>		<b>30 W/K</b>		<b>45 W/K</b>		
Max. rated current per fan	0.11 A/0.13 A	0.23 A/0.25 A	0.28 A/0.34 A	0.55 A/0.7 A	0.3 A/0.4 A	0.6 A/0.8 A	
Pre-fuse T	2.0 A						
Output per fan	23 W/27 W		60 W/75 W		70 W/90 W		
Operating temperature range	-5°C to +55°C						
Air throughput of fans (unimpeded air flow)	External circuit	265 m³/h / 315 m³/h		480 m³/h / 525 m³/h		600 m³/h / 625 m³/h	
	Internal circuit	265 m³/h / 315 m³/h		480 m³/h / 525 m³/h		600 m³/h / 625 m³/h	
Weight	10 kg		18 kg		19 kg		
<b>Accessories</b>	Packs of						
Filter mats	3	3286.300	3286.300	3286.400	3286.400	3286.400	299
Metal filters	1	3286.310	3286.310	3286.410	3286.410	3286.410	300

Special voltages available on request. We reserve the right to make technical modifications.

## Wall-mounted with controller, 60 – 90 W/K

Model No. SK	3129.100	3129.115	3130.100	3130.115	Page
Rated operating voltage V, Hz	230, 1~, 50/60	115, 1~, 50/60	230, 1~, 50/60	115, 1~, 50/60	
Dimensions mm	W x H x D 400 x 950 x 225		400 x 1580 x 215		
<b>Specific thermal output</b>	<b>60 W/K</b>		<b>90 W/K</b>		
Max. rated current per fan	0.38 A/0.4 A		0.65 A/0.8 A		1.3 A/1.8 A
Pre-fuse T	2.0 A				
Output per fan	85 W/90 W		150 W/200 W		
Operating temperature range	-5°C to +55°C				
Air throughput of fans (unimpeded air flow)	External circuit	860 m³/h / 900 m³/h		850 m³/h / 945 m³/h	
	Internal circuit	860 m³/h / 900 m³/h		850 m³/h / 945 m³/h	
Weight	21 kg		34 kg		
<b>Accessories</b>	Packs of				
Filter mats	3	3286.400	3286.400	3286.400	299
Metal filters	1	3286.410	3286.410	3286.410	300

Special voltages available on request. We reserve the right to make technical modifications.

# Air/air heat exchangers



Climate control accessories Page 291 Software & services Page 333

Rittal air/air heat exchangers in a railway-compatible version are used specifically in the mobile railway engineering sector, e.g. for local trains, locomotives and high-speed trains. Products are available both in 24 V DC and in 110 V DC.

Railway-compatible design of the units means construction to EN 50 155, halogen-free connection cables, screw protection, shock and vibration testing to EN 61 373, preparation for EN 45 545, and spray-finishing in RAL 7035 S to DB TL 918340, among other things.

#### Benefits:

- External and internal fans may be controlled separately
- Simple maintenance

**Colour:**  
RAL 7035

**Protection category:**  
Internal circuit IP 54 to IEC 60 529

#### Supply includes:

Complete unit ready for connection.

#### Detailed drawings:

Available on the Internet.

## Wall-mounted, railway-compatible version

Model No. SK		3126.424	3128.424	3129.424	3130.424	3126.410	3128.410	3129.410	3130.410	Page
Rated operating voltage		24 V (DC)	24 V (DC)	24 V (DC)	24 V (DC)	110 V (DC)	110 V (DC)	110 V (DC)	110 V (DC)	
Dimensions mm	W	280	400	400	400	280	400	400	400	
	H	650	950	950	1580	650	950	950	1580	
	D	127	140	150	150	127	140	150	150	
<b>Specific thermal output</b>		<b>27 W/K</b>	<b>47 W/K</b>	<b>66 W/K</b>	<b>98 W/K</b>	<b>27 W/K</b>	<b>47 W/K</b>	<b>66 W/K</b>	<b>98 W/K</b>	
Max. rated current per fan		2.7 A	7.5 A	10.5 A	9.2 A	2.7 A	1.9 A	2.47 A	2.3 A	
Output per fan		65 W	180 W	240 W	220 W	65 W	203 W	256 W	230 W	
Air throughput of fans (unimpeded air flow)	External circuit	360 m <sup>3</sup> /h	560 m <sup>3</sup> /h	1055 m <sup>3</sup> /h	1125 m <sup>3</sup> /h	360 m <sup>3</sup> /h	560 m <sup>3</sup> /h	1055 m <sup>3</sup> /h	1125 m <sup>3</sup> /h	
	Internal circuit	360 m <sup>3</sup> /h	560 m <sup>3</sup> /h	1055 m <sup>3</sup> /h	1125 m <sup>3</sup> /h	360 m <sup>3</sup> /h	560 m <sup>3</sup> /h	1055 m <sup>3</sup> /h	1125 m <sup>3</sup> /h	
Operating temperature range		-30°C to +60°C								
Weight		10 kg	16 kg	18 kg	25 kg	12.5 kg	18.5 kg	205 kg	27.5 kg	
<b>Accessories</b>	Packs of									
Adjustable frame	1	3286.260	3286.270	3286.270	3286.280	3286.260	3286.270	3286.270	3286.280	297
Metal filters	1	3286.230	3286.240	3286.240	3286.250	3286.230	3286.240	3286.240	3286.250	300

Extended delivery times. We reserve the right to make technical modifications.



## Rittal Israel

RITTAL Enclosure Systems Ltd.  
13, Hatarshish St. Zone 29 · P.O. Box 3597  
Industrial Park, Caesarea 38900  
Phone: +972 (0) 4 6275 505  
Fax: +972 (0) 4 6275 535  
E-mail: moshe@rittal.co.il  
www.rittal.co.il



Climate control accessories Page 291 Software & services Page 333

**Colour:**

RAL 7035/9005

**Protection category:**

Internal circuit IP 54 to IEC 60 529

**Supply includes:**

- Complete unit ready for connection
- The fans are connected via two 3-wire connection cables, with wire end ferrules.

**Note:**

For precise temperature control inside the enclosure, we recommend the digital temperature indicator/thermostat SK 3114.200, the enclosure internal thermostat SK 3110.000 or the speed control SK 3120.200.

**Detailed drawings:**

Available on the Internet.

## Roof-mounted

<b>Model No. SK</b>	<b>3248.000</b>		Page
Rated operating voltage V, Hz	230, 1~, 50/60		
Dimensions mm	W	595	
	H	362	
	D	440	
<b>Specific thermal output</b>	<b>66 W/K</b>		
Fans	2 per heat exchanger		
Max. rated current per fan	0.45 A/0.55 A		
Pre-fuse T	4.0 A		
Output per fan	75 W		
Air throughput of fans (unimpeded air flow)	External circuit	965 m <sup>3</sup> /h	
	Internal circuit	965 m <sup>3</sup> /h	
Operating temperature range	-5°C to +55°C		
Type of connection	Connection cable		
Weight	168 kg		
<b>Accessories</b>	Packs of		
Digital temperature display/thermostat	1	3114.200	293
Enclosure internal thermostat	1	3110.000	294
Hygrostat	1	3118.000	294
Speed control	1	3120.200	295

Special voltages available on request. We reserve the right to make technical modifications.



# Cooling units

## Thermoelectric coolers

Thermoelectric coolers.....	100 W.....	232
-----------------------------	------------	-----

## Wall-mounted cooling units

TopTherm, horizontal format .....	300 W.....	233
TopTherm .....	300 W.....	234
TopTherm "Blue e" .....	500 W.....	235
TopTherm "Blue e" .....	750 W.....	236
TopTherm "Blue e" .....	1000 W.....	237
TopTherm "Blue e" .....	1500 W.....	238
TopTherm "Blue e" .....	2000 W.....	239
TopTherm "Blue e" .....	2500 W.....	240
TopTherm "Blue e" .....	4000 W.....	240
TopTherm "Blue e", slimline .....	1500 W.....	241
TopTherm "Blue e", design NEMA 4X.....	500/1000/1500 W.....	242
TopTherm "Blue e", design NEMA 4X.....	2000/2500 W.....	243
TopTherm "Blue e", Ex cooling units for zone 22 (dust) .....	500/1000/1500 W.....	243

## Roof-mounted cooling units

TopTherm "Blue e" .....	500 W.....	244
TopTherm "Blue e" .....	750 W.....	245
TopTherm "Blue e" .....	1000 W.....	245
TopTherm "Blue e" .....	1100/3000 W.....	246
TopTherm "Blue e" .....	1500 W.....	246
TopTherm "Blue e" .....	2000 W.....	247
TopTherm "Blue e" .....	3000/4000 W.....	247

## Modular climate control concept

Cooling modules "Blue e" .....	1500/2500 W.....	248
Section doors for installing cooling modules .....		249



## TopTherm cooling units – generation "Blue e"

- Energy-saving range of cooling units in the output range from 500 to 4000 W.
- Savings of up to 45% energy consumption with the same cooling output (ideally 70% compared with a conventional Rittal TopTherm Plus cooling unit in field trials).
- Further information can be found on the Internet at [www.rittal.com](http://www.rittal.com) under "System climate control".



## Eco-Mode control

Intelligent, targeted use of energy thanks to the new eco-mode control from Rittal.

# Thermoelectric coolers



Climate control accessories Page 291 Therm software Page 341

### Protection category:

- External circuit IP 34 to IEC 60 529
- Internal circuit IP 54 to IEC 60 529

### Supply includes:

- Thermoelectric climate control unit
- Fully wired ready for connection
- Mounting accessories
- Parameterization software.

### Detailed drawing:

Available on the Internet.

### Performance diagrams:

Available on the Internet.

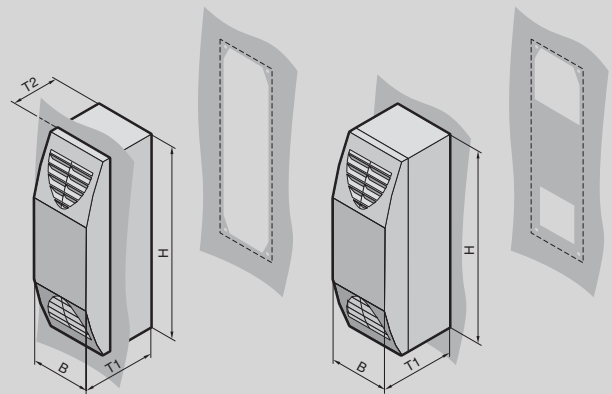

## Useful cooling output 100 W/thermal output 100 W

Model No. SK	3201.200	3201.300	Page	
Dimensions mm	W (B)	125		
	H	400		
	D (T1)	155		
Installation depth mm	D (T2)	100		
Rated operating voltage V, Hz	100 – 230 V, 50/60	24 V DC		
Start-up current	4.6 A	4.5 A		
Rated current	0.7 A	4.5 A		
Refrigeration factor/COP	L 35 L 35	1.0	1.2	
<b>Useful cooling output <math>\dot{Q}_k</math> to DIN 3168</b>	<b>L 35 L 35</b>	<b>100 W</b>	<b>100 W</b>	
<b>Thermal output</b>	<b>100 W</b>	<b>100 W</b>		
Power pack integrated	■	–		
Colour of cover/unit	RAL 7024/anodised aluminium			
Weight	3.0 kg	2.4 kg		
Operating temperature range	–30°C to +55°C	–30°C to +60°C		
Air throughput, unimpeded air flow	50 m³/h			
Type of connection	Plug-in spring connection terminal			
Pre-fuse T	4 A	10 A		
<b>Accessories</b>	Packs of			
Auto Range power pack 240 W	1	–	3201.040	302
Spare filter mat	1	3201.050	3201.050	301
Digital temperature display/thermostat	1	3114.200	3114.200	293
Master/slave adaptor	1	3201.070	3201.070	295
Condensate hose, 5 m length	1	3301.606	3301.606	303

We reserve the right to make technical modifications. Special voltages available on request.



# Wall-mounted cooling units



Climate control accessories Page 291 Software & services Page 333

### Protection category:

- External circuit IP 34 to IEC 60 529
- Internal circuit IP 54 to IEC 60 529

### Supply includes:

- Nano-coated condenser
- Wired ready for connection (plug-in terminal strip)
- Drilling template
- Assembly parts

### Approvals:

Available on the Internet.

### Detailed drawing:

Available on the Internet.

### Performance diagrams:

Available on the Internet.

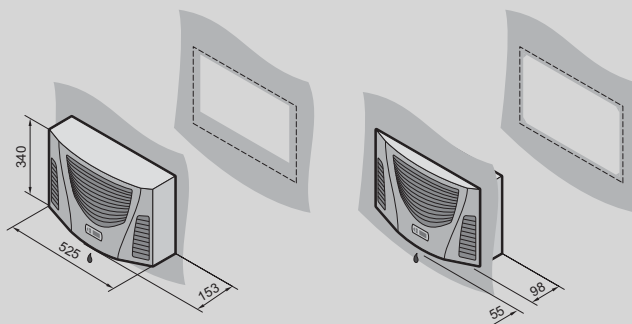

## TopTherm, horizontal format, useful cooling output 300 W

Model No. SK		3302.300	3302.310	Page
Material		Sheet steel		
Colour		RAL 7035		
Rated operating voltage V, Hz		230, 1~, 50/60	115, 1~, 60	
Dimensions mm	W x H x D	525 x 340 x 153		
<b>Useful cooling output <math>\dot{Q}_K</math> to DIN 3168</b>	<b>L 35 L 35 L 35 L 50</b>	<b>300 W/320 W 150 W/160 W</b>	<b>300 W 150 W</b>	
Rated current max.		1.6 A/1.7 A	4.0 A	
Start-up current		4.3 A/5.3 A	12.0 A	
Pre-fuse T		10.0 A	10.0 A	
Power consumption $P_{el}$ to DIN 3168	L 35 L 35 L 35 L 50	285 W/300 W 320 W/340 W	290 W 340 W	
Refrigeration factor $\epsilon = \dot{Q}_K/P_{el}$	L 35 L 35	1.1		
Refrigerant		R134a, 100 g	R134a, 95 g	
Permissible operating pressure p. max.		25 bar		
Operating temperature range		+20°C to +55°C		
Setting range		+30°C to +55°C		
Weight		13 kg		
Air throughput of fans	External circuit	345 m <sup>3</sup> /h		
	Internal circuit	310 m <sup>3</sup> /h		
Temperature control		Basic controller		
<b>Accessories</b>	<b>Packs of</b>			
Digital temperature display/thermostat	1	3114.200	3114.200	293
Condensate hose	1	3301.608	3301.608	303
Filter mats	3	3286.110	3286.110	299
Metal filters	1	3286.120	3286.120	300
Door-operated switch	1	4127.010	4127.010	496

Special voltages available on request. We reserve the right to make technical modifications.

# Wall-mounted cooling units



Climate control accessories Page 291 Software & services Page 333

## Protection category:

- External circuit IP 34 to IEC 60 529
- Internal circuit IP 54 to IEC 60 529

## Supply includes:

- Nano-coated condenser
- Wired ready for connection (plug-in terminal strip)
- Drilling template
- Assembly parts

## Approvals:

Available on the Internet.

## Detailed drawing:

Available on the Internet.

## Performance diagrams:

Available on the Internet.

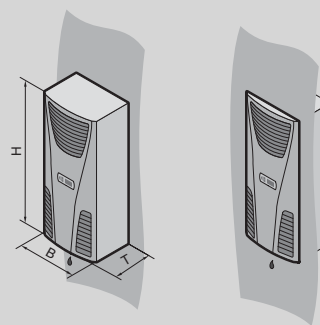

## TopTherm, useful cooling output 300 W

Model No. SK	3302.100	3302.110	3302.200 <sup>1)</sup>	3302.210 <sup>1)</sup>	Page
Material	Sheet steel		Stainless steel		
Colour	RAL 7035		-		
Rated operating voltage V, Hz	230, 1~, 50/60	115, 1~, 60	230, 1~, 50/60	115, 1~, 60	
Dimensions mm	W (B) x H x D (T) 280 x 550 x 140				
<b>Useful cooling output <math>\dot{Q}_K</math> to DIN 3168</b>	<b>L 35 L 35 L 35 L 50</b>	<b>300 W/320 W 150 W/170 W</b>	<b>300 W 150 W</b>	<b>300 W/320 W 150 W/170 W</b>	<b>300 W 150 W</b>
Rated current max.	1.6 A/1.7 A	3.3 A	1.6 A/1.7 A	3.3 A	
Start-up current	3.0 A/3.4 A	8.0 A	3.0 A/3.4 A	8.0 A	
Pre-fuse T	10.0 A	10.0 A	10.0 A	10.0 A	
Power consumption $P_{el}$ to DIN 3168	L 35 L 35 L 35 L 50	245 W/255 W 255 W/275 W	290 W 340 W	245 W/255 W 255 W/275 W	290 W 340 W
Refrigeration factor $\epsilon = \dot{Q}_K/P_{el}$	L 35 L 35	1.2			
Refrigerant	R134a, 100 g				
Permissible operating pressure p. max.	25 bar				
Operating temperature range	+20°C to +55°C				
Setting range	+30°C to +55°C				
Weight	13 kg				
Air throughput of fans	External circuit	310 m <sup>3</sup> /h			
	Internal circuit	345 m <sup>3</sup> /h			
Temperature control	Basic controller (factory setting +35°C)				
<b>Accessories</b>	Packs of				
Filter mats	3	3286.300	3286.300	3286.300	299
Metal filters	1	3286.310	3286.310	3286.310	300
Door-operated switch	1	4127.010	4127.010	4127.010	496
Digital temperature display/thermostat	1	3114.200	3114.200	3114.200	293
Condensate hose	1	3301.608	3301.608	3301.608	303

<sup>1)</sup> Extended delivery times.

Special voltages available on request. We reserve the right to make technical modifications.

# Wall-mounted cooling units



Climate control accessories Page 291 Software & services Page 333

### Protection category:

- External circuit IP 34 to IEC 60 529
- Internal circuit IP 54 to IEC 60 529

### Supply includes:

- Nano-coated condenser
- Wired ready for connection (plug-in terminal strip)
- Drilling template
- Assembly parts

### Approvals:

Available on the Internet.

### Detailed drawing:

Available on the Internet.

### Performance diagrams:

Available on the Internet.

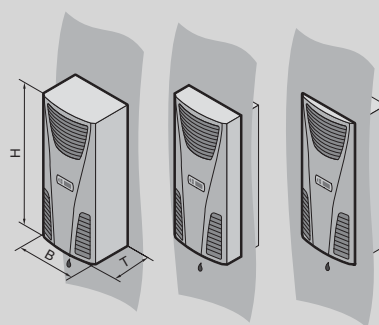

## TopTherm "Blue e", useful cooling output 500 W



Model No. SK	3303.500	3303.510	3303.600 <sup>1)</sup>	3303.610 <sup>1)</sup>	Page
Material	Sheet steel		Stainless steel		
Colour	RAL 7035		-		
Rated operating voltage V, Hz	230, 1~, 50/60	115, 1~, 60	230, 1~, 50/60	115, 1~, 60	
Dimensions mm	W (B) x H x D (T)		280 x 550 x 210		
<b>Useful cooling output <math>\dot{Q}_K</math> to DIN 3168</b>	<b>L 35 L 35 L 35 L 50</b>	<b>500 W/610 W 280 W/350 W</b>	<b>500 W 280 W</b>	<b>500 W/610 W 280 W/350 W</b>	<b>500 W 280 W</b>
Rated current max.	2.6 A/2.6 A	5.7 A	2.6 A/2.6 A	5.7 A	
Start-up current	5.1 A/6.4 A	11.5 A	5.1 A/6.4 A	11.5 A	
Pre-fuse T	10.0 A	10.0 A	10.0 A	10.0 A	
Power consumption $P_{el}$ to DIN 3168	L 35 L 35 L 35 L 50	360 W/380 W 420 W/390 W	470 W 500 W	360 W/380 W 420 W/390 W	470 W 500 W
Refrigeration factor $\epsilon = \dot{Q}_K/P_{el}$	L 35 L 35	1.4			
Refrigerant	R134a, 170 g				
Permissible operating pressure p. max.	28 bar				
Operating temperature and setting range	+20°C to +55°C				
Weight	17 kg				
Air throughput of fans	External circuit	345 m <sup>3</sup> /h			
	Internal circuit	310 m <sup>3</sup> /h			
Temperature control	e-Comfort controller (factory setting +35°C)				
<b>Accessories</b>	Packs of				
Filter mats	3	3286.300	3286.300	3286.300	299
Metal filters	1	3286.310	3286.310	3286.310	300
Door-operated switch	1	4127.010	4127.010	4127.010	496
SK BUS system	1	3124.100	3124.100	3124.100	295
RiDiag II	1	3159.100	3159.100	3159.100	347
Interface board	1	3124.200	3124.200	3124.200	295
Condensate hose	1	3301.610	3301.610	3301.610	303

<sup>1)</sup> Extended delivery times.

Special voltages available on request. We reserve the right to make technical modifications.

# Wall-mounted cooling units

## TopTherm "Blue e", useful cooling output 750 W



Model No. SK		3361.500	3361.510	3361.540	3361.600 <sup>1)</sup>	3361.610 <sup>1)</sup>	3361.640 <sup>1)</sup>	Page
Material		Sheet steel			Stainless steel			
Colour		RAL 7035			-			
Rated operating voltage V, Hz		230, 1~, 50/60 <sup>3)</sup>	115, 1~, 60 <sup>3)</sup>	400 <sup>2)</sup> , 2~, 50/60 <sup>3)</sup>	230, 1~, 50/60 <sup>3)</sup>	115, 1~, 60 <sup>2)</sup>	400 <sup>2)</sup> , 2~, 50/60 <sup>3)</sup>	
Dimensions mm	W x H x D	280 x 550 x 206						
<b>Useful cooling output <math>\dot{Q}_K</math> to DIN 3168</b>	<b>L 35 L 35 L 35 L 50</b>	<b>750 W/790 W 570 W/570 W</b>	<b>750 W 500 W</b>	<b>750 W/790 W 570 W/570 W</b>	<b>750 W/790 W 570 W/570 W</b>	<b>750 W 500 W</b>	<b>750 W/790 W 570 W/570 W</b>	
Rated current max.		2.7 A/2.7 A	5.3 A	1.2 A/1.4 A	2.7 A/2.7 A	5.3 A	1.2 A/1.4 A	
Start-up current		6.0 A/9.6 A	12.0 A	3.1 A/3.3 A	6.0 A/9.6 A	12.0 A	3.1 A/3.3 A	
Pre-fuse T		10.0 A	10.0 A	6.3 A – 10.0 A <sup>4)</sup>	10.0 A	10.0 A	6.3 A – 10.0 A <sup>4)</sup>	
Power consumption $P_{el}$ to DIN 3168	L 35 L 35 L 35 L 50	420 W/450 W 480 W/510 W	570 W 670 W	450 W/470 W 520 W/550 W	420 W/450 W 480 W/510 W	570 W 670 W	450 W/470 W 520 W/550 W	
Refrigeration factor $\varepsilon = \dot{Q}_K/P_{el}$	L 35 L 35	1.8	1.3	1.7	1.8	1.3	1.7	
Refrigerant		R134a, 280 g	R134a, 260 g	R134a, 280 g	R134a, 280 g	R134a, 260 g	R134a, 280 g	
Permissible operating pressure p. max.		28 bar						
Operating temperature and setting range		+20°C to +55°C						
Weight		22 kg						
Air throughput of fans	External circuit Internal circuit	480 m <sup>3</sup> /h 600 m <sup>3</sup> /h						
Temperature control		e-Comfort controller (factory setting +35°C)						
<b>Accessories</b>	Packs of							
Filter mats	3	3286.300	3286.300	3286.300	3286.300	3286.300	3286.300	299
Metal filters	1	3286.310	3286.310	3286.310	3286.310	3286.310	3286.310	300
Door-operated switch	1	4127.010	4127.010	4127.010	4127.010	4127.010	4127.010	496
SK BUS system	1	3124.100	3124.100	3124.100	3124.100	3124.100	3124.100	295
RiDiag II	1	3159.100	3159.100	3159.100	3159.100	3159.100	3159.100	347
Interface board	1	3124.200	3124.200	3124.200	3124.200	3124.200	3124.200	295
Condensate hose	1	3301.610	3301.610	3301.610	3301.610	3301.610	3301.610	303

<sup>1)</sup> Extended delivery times. <sup>2)</sup> External toroidal core transformer Ø 126 x 65 mm deep for mounting in the enclosure.

<sup>3)</sup> T<sub>u</sub> max. = 53°C/60 Hz. <sup>4)</sup> Transformer protection switch.

Special voltages available on request. We reserve the right to make technical modifications.



## Rittal Canada

RITTAL Systems Ltd.  
6485 Ordan Drive • Mississauga ON L5T 1X2  
Canada  
Phone: +1 (905) 795-0777  
Fax: +1 (905) 795-9548  
Toll-free: 1-800-399-0748  
E-mail: [marketing@rittal.ca](mailto:marketing@rittal.ca) • [www.rittal.ca](http://www.rittal.ca)

# Wall-mounted cooling units



Climate control accessories Page 291 Software & services Page 333

### Protection category:

- External circuit IP 34 to IEC 60 529
- Internal circuit IP 54 to IEC 60 529

### Supply includes:

- Nano-coated condenser
- Integral electric condensate evaporation
- Wired ready for connection (plug-in terminal strip)
- Drilling template
- Assembly parts

### Approvals:

Available on the Internet.

### Detailed drawing:

Available on the Internet.

### Performance diagrams:

Available on the Internet.

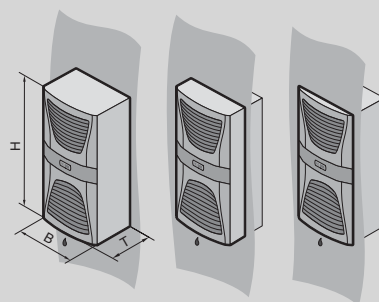

## TopTherm "Blue e", useful cooling output 1000 W



Model No. SK	3304.500	3304.510	3304.540	3304.600 <sup>1)</sup>	3304.610 <sup>1)</sup>	3304.640 <sup>1)</sup>	Page
Material	Sheet steel			Stainless steel			
Colour	RAL 7035						
Rated operating voltage V, Hz	230, 1~, 50/60	115, 1~, 50/60	400, 3~, 50/460, 3~, 60	230, 1~, 50/60	115, 1~, 50/60	400, 3~, 50/460, 3~, 60	
Dimensions mm	W (B) x H x D (T) 400 x 950 x 260						
<b>Useful cooling output <math>\dot{Q}_K</math> to DIN 3168</b>	<b>L 35 L 35 L 35 L 50</b>	<b>1000 W/1450 W 1050 W/1100 W</b>	<b>1000 W/1450 W 980 W/1050 W</b>	<b>1000 W/1460 W 880 W/890 W</b>	<b>1000 W/1450 W 1050 W/1100 W</b>	<b>1000 W/1450 W 1050 W/1100 W</b>	<b>1000 W/1460 W 880 W/990 W</b>
Rated current max.	3.9 A/4.3 A	8.0 A/8.8 A	2.2 A/2.1 A	3.9 A/4.3 A	8.0 A/8.8 A	2.2 A/2.1 A	
Start-up current	12.0 A/14.0 A	26.0 A/28.0 A	11.5 A/12.7 A	12.0 A/14.0 A	26.0 A/28.0 A	11.5 A/12.7 A	
Pre-fuse T	10.0 A	11.0 A – 16.0 A	6.3 A – 10.0 A <sup>2)</sup>	10.0 A	11.0 A – 16.0 A	6.3 A – 10.0 A <sup>2)</sup>	
Power consumption $P_{el}$ to DIN 3168	L 35 L 35 L 35 L 50	640 W/720 W 750 W/850 W	670 W/750 W 780 W/880 W	670 W/820 W 760 W/930 W	640 W/720 W 750 W/850 W	670 W/750 W 780 W/880 W	670 W/820 W 760 W/930 W
Refrigeration factor $\epsilon = \dot{Q}_K/P_{el}$	L 35 L 35	1.6	1.7	1.6	1.7	1.7	
Refrigerant	R134a, 325 g						
Permissible operating pressure p. max.	25 bar						
Operating temperature and setting range	+20°C to +55°C						
Weight	39 kg	44 kg	40 kg	39 kg	44 kg	40 kg	
Air throughput of fans	External circuit	900 m <sup>3</sup> /h					
	Internal circuit	600 m <sup>3</sup> /h					
Temperature control	e-Comfort controller (factory setting +35°C)						
<b>Accessories</b>	Packs of						
Filter mats	3	3286.400	3286.400	3286.400	3286.400	3286.400	299
Metal filters	1	3286.410	3286.410	3286.410	3286.410	3286.410	300
Door-operated switch	1	4127.010	4127.010	4127.010	4127.010	4127.010	496
SK BUS system	1	3124.100	3124.100	3124.100	3124.100	3124.100	295
RiDiag II	1	3159.100	3159.100	3159.100	3159.100	3159.100	347
Interface board	1	3124.200	3124.200	3124.200	3124.200	3124.200	295
Condensate hose	1	3301.612	3301.612	3301.612	3301.612	3301.612	303

<sup>1)</sup> Extended delivery times. <sup>2)</sup> Motor circuit-breaker.

Special voltages and other output categories available on request. We reserve the right to make technical modifications.

# Wall-mounted cooling units

## TopTherm "Blue e", useful cooling output 1500 W



Model No. SK		3305.500	3305.510 <sup>1)</sup>	3305.540	3305.600 <sup>1)</sup>	3305.610 <sup>1)</sup>	3305.640 <sup>1)</sup>	Page
Material		Sheet steel			Stainless steel			
Colour		RAL 7035			-			
Rated operating voltage V, Hz		230, 1~, 50/60	115, 1~, 50/60	400, 3~, 50/ 460, 3~, 60	230, 1~, 50/60	115, 1~, 50/60	400, 3~, 50/ 460, 3~, 60	
Dimensions mm	W x H x D	400 x 950 x 260						
<b>Useful cooling output <math>\dot{Q}_K</math> to DIN 3168</b>	<b>L 35 L 35 L 35 L 50</b>	<b>1500 W/1510 W 1150 W/1200 W</b>	<b>1500 W/1660 W 1150 W/1270 W</b>	<b>1500 W/1510 W 1230 W/1250 W</b>	<b>1500 W/1510 W 1150 W/1200 W</b>	<b>1500 W/1660 W 1150 W/1270 W</b>	<b>1500 W/1510 W 1230 W/1250 W</b>	
Rated current max.		5.5 A/5.8 A	11.5 A/12.5 A	2.5 A/2.8 A	5.5 A/5.8 A	11.5 A/12.5 A	2.5 A/2.8 A	
Start-up current		12.0 A/14.0 A	26.0 A/28.0 A	12.2 A/11.3 A	12.0 A/14.0 A	26.0 A/28.0 A	12.2 A/11.3 A	
Pre-fuse T		16.0 A/16.0 A	14.0 A – 20.0 A <sup>3)</sup>	6.3 A – 10.0 A <sup>2)</sup>	16.0 A/16.0 A	14.0 A – 20.0 A <sup>3)</sup>	6.3 A – 10.0 A <sup>2)</sup>	
Power consumption $P_{el}$ to DIN 3168	L 35 L 35 L 35 L 50	870 W/890 W 1030 W/1150 W	1010 W/900 W 1180 W/1060 W	820 W/1000 W 980 W/1170 W	870 W/890 W 1030 W/1150 W	1010 W/900 W 1180 W/1060 W	820 W/1000 W 980 W/1170 W	
Refrigeration factor $\varepsilon = \dot{Q}_K/P_{el}$	L 35 L 35	1.7	1.5	1.8	1.7	1.5	1.8	
Refrigerant		R134a, 600 g						
Permissible operating pressure p. max.		25 bar						
Operating temperature and setting range		+20°C to +55°C						
Weight		41 kg	46 kg	42 kg	41 kg	46 kg	42 kg	
Air throughput of fans	External circuit Internal circuit	900 m <sup>3</sup> /h 800 m <sup>3</sup> /h						
Temperature control		e-Comfort controller (factory setting +35°C)						
<b>Accessories</b>	Packs of							
Filter mats	3	3286.400	3286.400	3286.400	3286.400	3286.400	3286.400	299
Metal filters	1	3286.410	3286.410	3286.410	3286.410	3286.410	3286.410	300
Door-operated switch	1	4127.010	4127.010	4127.010	4127.010	4127.010	4127.010	496
SK BUS system	1	3124.100	3124.100	3124.100	3124.100	3124.100	3124.100	295
RiDiag II	1	3159.100	3159.100	3159.100	3159.100	3159.100	3159.100	347
Interface board	1	3124.200	3124.200	3124.200	3124.200	3124.200	3124.200	295
Condensate hose	1	3301.612	3301.612	3301.612	3301.612	3301.612	3301.612	303

<sup>1)</sup> Extended delivery times. <sup>2)</sup> Motor circuit breaker. <sup>3)</sup> Transformer protection switch.  
Special voltages available on request. We reserve the right to make technical modifications.



## Rittal Malaysia

RITTAL Systems Sdn Bhd  
7, Jalan TPP 1/1A Taman Industri Puchong  
Batu 12 · Jalan Puchong 47100 Puchong  
Solangor, Malaysia  
Phone: +603-8060 6688  
Fax: +603-8060 8866  
E-mail: sales@rittal.com.my · www.rittal.com.my

# Wall-mounted cooling units



Climate control accessories Page 291 Software & services Page 333

### Protection category:

- External circuit IP 34 to IEC 60 529
- Internal circuit IP 54 to IEC 60 529

### Supply includes:

- Nano-coated condenser
- Integral electric condensate evaporation
- Wired ready for connection (plug-in terminal strip)
- Drilling template
- Assembly parts

### Approvals:

Available on the Internet.

### Detailed drawing:

Available on the Internet.

### Performance diagrams:

Available on the Internet.

1 Cannot be installed with SK 3332.XXX.

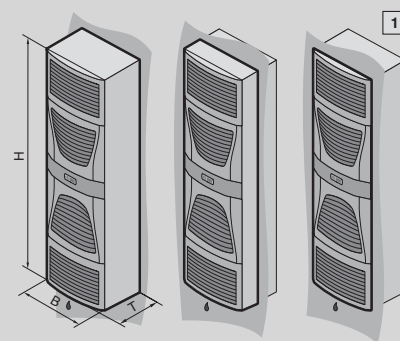

## TopTherm "Blue e", useful cooling output 2000 W



Model No. SK	3328.500	3328.510	3328.540	3328.600 <sup>1)</sup>	3328.610 <sup>1)</sup>	3328.640 <sup>1)</sup>	Page
Material	Sheet steel			Stainless steel			
Colour	RAL 7035			-			
Rated operating voltage V, Hz	230, 1~, 50/60	115, 1~, 50/60	400, 3~, 50/ 460, 3~, 60	230, 1~, 50/60	115, 1~, 50/60	400, 3~, 50/ 460, 3~, 60	
Dimensions mm W (B) x H x D (T)	400 x 1580 x 295						
<b>Useful cooling output <math>\dot{Q}_K</math> to DIN 3168</b>	<b>L 35 L 35 L 35 L 50</b>	<b>2000 W/2360 W 1620 W/1745 W</b>	<b>2000 W/2360 W 1620 W/1745 W</b>	<b>2000 W/2350 W 1450 W/1690 W</b>	<b>2000 W/2360 W 1620 W/1745 W</b>	<b>2000 W/2350 W 1450 W/1690 W</b>	
Rated current max.	6.1 A/6.6 A	13.4 A/14.8 A	2.8 A/3.3 A	6.1 A/6.6 A	13.4 A/14.8 A	2.8 A/3.3 A	
Start-up current	20.0 A/22.0 A	40.0 A/38.0 A	6.8 A/7.8 A	20.0 A/22.0 A	40.0 A/38.0 A	6.8 A/7.8 A	
Pre-fuse T	16.0 A	18.0 A – 25.0 A <sup>3)</sup>	6.3 A – 10.0 A <sup>2)</sup>	16.0 A	18.0 A – 25.0 A <sup>3)</sup>	6.3 A – 10.0 A <sup>2)</sup>	
Power consumption $P_{el}$ to DIN 3168	L 35 L 35 L 35 L 50	935 W/1055 W 1080 W/1250 W	965 W/1085 W 1110 W/1280 W	920 W/1145 W 1145 W/1395 W	935 W/1055 W 1080 W/1250 W	965 W/1085 W 1110 W/1280 W	920 W/1145 W 1145 W/1395 W
Refrigeration factor $\epsilon = \dot{Q}_K/P_{el}$	L 35 L 35	2.1	2.1	2.2	2.1	2.1	2.2
Refrigerant	R134a, 950 g						
Permissible operating pressure p. max.	28 bar						
Operating temperature and setting range	+20°C to +55°C						
Weight	66 kg	73 kg	67 kg	66 kg	73 kg	67 kg	
Air throughput of fans	External circuit	640 m <sup>3</sup> /h		Internal circuit	550 m <sup>3</sup> /h		
Temperature control	e-Comfort controller (factory setting +35°C)						
<b>Accessories</b>	Packs of						
Filter mats	3	3286.400	3286.400	3286.400	3286.400	3286.400	299
Metal filters	1	3286.410	3286.410	3286.410	3286.410	3286.410	300
Door-operated switch	1	4127.010	4127.010	4127.010	4127.010	4127.010	496
SK BUS system	1	3124.100	3124.100	3124.100	3124.100	3124.100	295
RiDiag II	1	3159.100	3159.100	3159.100	3159.100	3159.100	347
Interface board	1	3124.200	3124.200	3124.200	3124.200	3124.200	295
Condensate hose	1	3301.612	3301.612	3301.612	3301.612	3301.612	303

<sup>1)</sup> Extended delivery times. <sup>2)</sup> Motor circuit breaker. <sup>3)</sup> Transformer protection switch.  
Special voltages available on request. We reserve the right to make technical modifications.

# Wall-mounted cooling units

## TopTherm "Blue e", useful cooling output 2500 W



Model No. SK		3329.500	3329.510	3329.540	3329.600 <sup>1)</sup>	3329.610 <sup>1)</sup>	3329.640 <sup>1)</sup>	Page
Material		Sheet steel			Stainless steel			
Colour		RAL 7035			-			
Rated operating voltage V, Hz		230, 1~, 50/60	115, 1~, 50/60	400, 3~, 50/460, 3~, 60	230, 1~, 50/60	115, 1~, 50/60	400, 3~, 50/460, 3~, 60	
Dimensions mm	W (B) x H x D (T)	400 x 1580 x 295			400 x 1580 x 295			
<b>Useful cooling output <math>\dot{Q}_K</math> to DIN 3168</b>	<b>L 35 L 35 L 35 L 50</b>	<b>2500 W/2660 W 1840 W/1920 W</b>		<b>2500 W/2700 W 1900 W/1950 W</b>	<b>2500 W/2660 W 1840 W/1920 W</b>		<b>2500 W/2700 W 1900 W/1950 W</b>	
Rated current max.		8.2 A/9.3 A	17.0 A/20.0 A	3.7 A/3.8 A	8.2 A/9.3 A	17.0 A/20.0 A	3.7 A/3.8 A	
Start-up current		20.0 A/24.0 A	44.0 A/42.0 A	6.8 A/7.6 A	20.0 A/24.0 A	44.0 A/42.0 A	6.8 A/7.6 A	
Pre-fuse T		16.0 A	18.0 A – 25.0 A <sup>3)</sup>	6.3 A – 10.0 A <sup>2)</sup>	16.0 A	18.0 A – 25.0 A <sup>3)</sup>	6.3 A – 10.0 A <sup>2)</sup>	
Power consumption $P_{el}$ to DIN 3168	L 35 L 35 L 35 L 50	1270 W/1410 W 1470 W/1700 W	1300 W/1440 W 1500 W/1730 W	1295 W/1495 W 1545 W/1845 W	1270 W/1410 W 1470 W/1700 W	1300 W/1440 W 1500 W/1730 W	1295 W/1495 W 1545 W/1845 W	
Refrigeration factor $\epsilon = \dot{Q}_K/P_{el}$	L 35 L 35	2.0	1.9	1.9	2.0	1.9	1.9	
Refrigerant		R134a, 950 g						
Permissible operating pressure p. max.		28 bar						
Operating temperature and setting range		+20°C to +55°C						
Weight		69 kg	76 kg	70 kg	69 kg	76 kg	70 kg	
Air throughput of fans	External circuit Internal circuit	710 m <sup>3</sup> /h 640 m <sup>3</sup> /h						
Temperature control		e-Comfort controller (factory setting +35°C)						
<b>Accessories</b>	Packs of							
Filter mats	3	3286.400	3286.400	3286.400	3286.400	3286.400	3286.400	299
Metal filters	1	3286.410	3286.410	3286.410	3286.410	3286.410	3286.410	300
Door-operated switch	1	4127.010	4127.010	4127.010	4127.010	4127.010	4127.010	496
SK BUS system	1	3124.100	3124.100	3124.100	3124.100	3124.100	3124.100	295
RiDiag II	1	3159.100	3159.100	3159.100	3159.100	3159.100	3159.100	347
Interface board	1	3124.200	3124.200	3124.200	3124.200	3124.200	3124.200	295
Condensate hose	1	3301.612	3301.612	3301.612	3301.612	3301.612	3301.612	303

<sup>1)</sup> Extended delivery times. <sup>2)</sup> Motor circuit breaker. <sup>3)</sup> Transformer protection switch.  
Special voltages available on request. We reserve the right to make technical modifications.

## TopTherm "Blue e", useful cooling output 4000 W



Model No. SK		3332.540		3332.640 <sup>1)</sup>	Page
Material		Sheet steel		Stainless steel	
Colour		RAL 7035		-	
Rated operating voltage V, Hz		400, 3~, 50/460, 3~, 60			
Dimensions mm	W (B) x H x D (T)	500 x 1580 x 340			
<b>Useful cooling output <math>\dot{Q}_K</math> to DIN 3168</b>	<b>L 35 L 35 L 35 L 50</b>	<b>4000 W/4400 W 3070 W/3570 W</b>			
Rated current max.		4.2 A/4.2 A			
Start-up current		9.2 A/11.0 A			
Pre-fuse T		6.3 A – 10.0 A <sup>2)</sup>			
Power consumption $P_{el}$ to DIN 3168	L 35 L 35 L 35 L 50	1720 W/2120 W 1990 W/2460 W			
Refrigeration factor $\epsilon = \dot{Q}_K/P_{el}$	L 35 L 35	2.3			
Refrigerant		R134a, 3000 g			
Permissible operating pressure p. max.		28 bar			
Operating temperature and setting range		+20°C to +55°C			
Weight		91 kg			
Air throughput of fans	External circuit Internal circuit	2000 m <sup>3</sup> /h 1500 m <sup>3</sup> /h			
Temperature control		e-Comfort controller (factory setting +35°C)			
<b>Accessories</b>	Packs of				
Filter mats	3	3286.400		3286.400	299
Metal filters	1	3286.410		3286.410	300
Door-operated switch	1	4127.010		4127.010	496
SK BUS system	1	3124.100		3124.100	295
RiDiag II	1	3159.100		3159.100	347
Interface board	1	3124.200		3124.200	295
Condensate hose	1	3301.612		3301.612	303

<sup>1)</sup> Extended delivery times. <sup>2)</sup> Motor circuit breaker.  
Special voltages available on request. We reserve the right to make technical modifications.



# Wall-mounted cooling units



Climate control accessories Page 291 Software & services Page 333

### Protection category:

- External circuit IP 34 to IEC 60 529
- Internal circuit IP 54 to IEC 60 529

### Supply includes:

- Nano-coated condenser
- Integral electric condensate evaporation
- Wired ready for connection (plug-in terminal strip)
- Drilling template
- Assembly parts

### Approvals:

Available on the Internet.

### Detailed drawing:

Available on the Internet.

### Performance diagrams:

Available on the Internet.

## TopTherm "Blue e", slimline, useful cooling output 1500 W



Model No. SK	3366.500	3366.510	3366.540	3366.600 <sup>1)</sup>	3366.610 <sup>1)</sup>	3366.640 <sup>1)</sup>	Page
Material	Sheet steel			Stainless steel			
Colour	RAL 7035			-			
Rated operating voltage V, Hz	230, 1~, 50/60	115, 1~, 50/60	400, 3~, 50/460, 3~, 60	230, 1~, 50/60	115, 1~, 50/60	400, 3~, 50/460, 3~, 60	
Dimensions mm	W x H x D 435 x 1590 x 205						
<b>Useful cooling output <math>\dot{Q}_k</math> to DIN 3168</b>	<b>L 35 L 35 L 35 L 50</b>	<b>1500 W/1500 W 1050 W/1100 W</b>	<b>1500 W/1500 W 980 W/1080 W</b>	<b>1500 W/1500 W 1050 W/1100 W</b>		<b>1500 W/1500 W 980 W/1080 W</b>	
Rated current max.	6.7 A/6.9 A	13.6 A/13.8 A	2.7 A/2.9 A	6.7 A/6.9 A	13.6 A/13.8 A	2.7 A/2.9 A	
Start-up current	22.0 A/24.0 A	43.0 A/47.0 A	8.0 A/8.8 A	22.0 A/24.0 A	43.0 A/47.0 A	8.0 A/8.8 A	
Pre-fuse T	10.0 A	14.0 A – 20.0 A <sup>3)</sup>	6.3 A – 10.0 A <sup>2)</sup>	10.0 A	14.0 A – 20.0 A <sup>3)</sup>	6.3 A – 10.0 A <sup>2)</sup>	
Power consumption $P_{ei}$ to DIN 3168	L 35 L 35 L 35 L 50	940 W/1070 W 1115 W/1230 W	940 W/1070 W 1115 W/1230 W	970 W/1120 W 1140 W/1310 W	940 W/1070 W 1115 W/1230 W	940 W/1070 W 1115 W/1230 W	970 W/1120 W 1140 W/1310 W
Refrigeration factor $\epsilon = \dot{Q}_k/P_{ei}$	L 35 L 35	1.6	1.5	1.6		1.5	
Refrigerant	R134a, 700 g						
Permissible operating pressure p. max.	28 bar						
Operating temperature and setting range	+20°C to +55°C						
Weight	45 kg	49 kg	46 kg	45 kg	49 kg	46 kg	
Air throughput of fans (unimpeded air flow)	External circuit	910 m <sup>3</sup> /h		Internal circuit	860 m <sup>3</sup> /h		
Temperature control	e-Comfort controller (factory setting +35°C)						
<b>Accessories</b>	Packs of						
Filter mats	3	3286.400	3286.400	3286.400	3286.400	3286.400	299
Metal filters	1	3286.410	3286.410	3286.410	3286.410	3286.410	300
Trim frame	1	3377.000	3377.000	3377.000	3377.000	3377.000	297
Door-operated switch	1	4127.010	4127.010	4127.010	4127.010	4127.010	496
SK BUS system	1	3124.100	3124.100	3124.100	3124.100	3124.100	295
RiDiag II	1	3159.100	3159.100	3159.100	3159.100	3159.100	347
Interface board	1	3124.200	3124.200	3124.200	3124.200	3124.200	295
Condensate hose	1	3301.612	3301.612	3301.612	3301.612	3301.612	303

<sup>1)</sup> Extended delivery times. <sup>2)</sup> Motor circuit breaker. <sup>3)</sup> Transformer protection switch.  
Special voltages available on request. We reserve the right to make technical modifications.

# Wall-mounted cooling units



Climate control accessories Page 291 Software & services Page 333

**Protection category:**  
See tables.

**Supply includes:**  
– Nano-coated condenser  
– Integral electric condensate evaporation  
– Wired ready for connection (plug-in terminal strip)

– Drilling template  
– Assembly parts

**Approvals:**  
Available on the Internet.

**Detailed drawing:**  
Available on the Internet.

**Performance diagrams:**  
Available on the Internet.

## TopTherm “Blue e”, design NEMA 4X, useful cooling output 500/1000/1500 W



Model No. SK	3303.504 <sup>2)</sup>	3303.514 <sup>2)</sup>	3304.504	3304.514	3304.544	3305.504	3305.514	3305.544	Page
Material	Stainless steel								
Rated operating voltage V, Hz	230, 1~, 50/60	115, 1~, 60	230, 1~, 50/60	115, 1~, 50/60	400, 3~, 50/460, 3~, 60	230, 1~, 50/60	115, 1~, 50/60	400, 3~, 50/460, 3~, 60	
Dimensions mm W x H x D	285 x 620 x 298		405 x 1020 x 358			405 x 1020 x 358			
Useful cooling output $\dot{Q}_K$ to DIN 3168	L 35 L 35	500 W/ 610 W	500 W	1000 W/ 1450 W	1000 W/ 1450 W	1000 W/ 1460 W	1500 W/ 1510 W	1500 W/ 1660 W	1500 W/ 1510 W
	L 35 L 50	280 W/ 350 W	280 W	1050 W/ 1100 W	980 W/ 1050 W	880 W/ 990 W	1150 W/ 1200 W	1150 W/ 1270 W	1230 W/ 1250 W
Rated current max.	2.6 A/ 2.6 A	5.7 A	3.9 A/ 4.3 A	8.0 A – 8.8 A	2.2 A – 2.1 A	5.5 A – 5.8 A	11.5 A – 12.5 A	2.6 A – 2.8 A	
Start-up current	5.1 A/ 6.4 A	11.5 A	12.0 A/ 14.0 A	26.0 A/ 28.0 A	11.5 A/ 12.7 A	12.0 A/ 14.0 A	26.0 A/ 28.0 A	12.2 A/ 11.3 A	
Pre-fuse T	10.0 A	10.0 A	10.0 A	11.0 A – 16.0 A	6.3 A – 10.0 A <sup>1)</sup>	16.0 A	14.0 A – 20.0 A <sup>3)</sup>	6.3 A – 10.0 A <sup>1)</sup>	
Power consumption $P_{el}$ to DIN 3168	L 35 L 35 L 35 L 50	360 W/ 380 W 420 W/ 390 W	470 W 500 W	640 W/ 720 W 750 W/ 850 W	670 W/ 750 W 780 W/ 880 W	670 W/ 820 W 760 W/ 930 W	870 W/ 890 W 1030 W/ 1150 W	1010 W/ 900 W 1180 W/ 1060 W	820 W/ 1000 W 980 W/ 1170 W
Refrigeration factor $\varepsilon = \dot{Q}_K/P_{el}$	L 35 L 35	1.4	1.6	1.6	1.7	1.7	1.5	1.8	
Refrigerant	R134a, 170 g		R134a, 325 g		R134a, 325 g	R134a, 600 g			
Permissible operating pressure p. max.	28 bar		25 bar						
Operating temperature and setting range	+20°C to +55°C								
Protection category	NEMA 4X								
Weight	25 kg		49 kg	54 kg	50 kg	51 kg	56 kg	52 kg	
Air throughput of fans	External circuit	345 m <sup>3</sup> /h		900 m <sup>3</sup> /h			900 m <sup>3</sup> /h		
	Internal circuit	310 m <sup>3</sup> /h		600 m <sup>3</sup> /h			800 m <sup>3</sup> /h		
Temperature control	e-Comfort controller (factory setting +35°C)								
<b>Accessories</b>	Packs of								
Door-operated switch	1	4127.010	4127.010	4127.010	4127.010	4127.010	4127.010	4127.010	496
SK BUS system	1	3124.100	3124.100	–	–	–	3124.100	3124.100	295
RiDiag II	1	3159.100	3159.100	3159.100	3159.100	3159.100	3159.100	3159.100	347
Interface board	1	3124.200	3124.200	3124.200	3124.200	3124.200	3124.200	3124.200	295
Condensate hose	1	3301.610	3301.610	3301.612	3301.612	3301.612	3301.612	3301.612	303

<sup>1)</sup> Motor circuit breaker. <sup>2)</sup> Without integral condensate evaporation. <sup>3)</sup> Transformer protection switch.  
Extended delivery times. Special voltages available on request. We reserve the right to make technical modifications.

# Wall-mounted cooling units



## TopTherm "Blue e", design NEMA 4X, useful cooling output 2000/2500 W

Model No. SK		3328.504	3328.514	3328.544	3329.504	3329.514	3329.544	Page	
Material		Stainless steel							
Rated operating voltage V, Hz		230, 1~, 50/60	115, 1~, 50/60	400, 3~, 50/460, 3~, 60	230, 1~, 50/60	115, 1~, 50/60	400, 3~, 50/460, 3~, 60		
Dimensions mm	W x H x D	405 x 1650 x 388							
<b>Useful cooling output <math>\dot{Q}_K</math> to DIN 3168</b>	<b>L 35 L 35 L 35 L 50</b>	<b>2000 W/2360 W 1620 W/1745 W</b>	<b>2000 W/2360 W 1620 W/1745 W</b>	<b>2000 W/2350 W 1450 W/1690 W</b>	<b>2500 W/2660 W 1840 W/1920 W</b>	<b>2500 W/2660 W 1840 W/1920 W</b>	<b>2500 W/2700 W 1900 W/1950 W</b>		
Rated current max.		6.1 A/6.6 A	13.4 A – 14.8 A	2.8 A/3.3 A	8.2 A/9.3 A	17.0 A/20.0 A	3.7 A/3.8 A		
Start-up current		20.0 A/22.0 A	40.0 A/38.0 A	6.8 A/7.8 A	20.0 A/24.0 A	44.0 A/42.0 A	6.8 A/7.6 A		
Pre-fuse T		16.0 A	18.0 A – 25.0 A <sup>2)</sup>	6.3 A – 10.0 A <sup>1)</sup>	16.0 A	18.0 A – 25.0 A <sup>2)</sup>	6.3 A – 10.0 A <sup>1)</sup>		
Power consumption $P_{el}$ to DIN 3168	L 35 L 35 L 35 L 50	935 W/1055 W 1080 W/1250 W	965 W/1085 W 1110 W/1280 W	920 W/1145 W 1145 W/1395 W	1270 W/1410 W 1470 W/1700 W	1300 W/1440 W 1500 W/1730 W	1295 W/1495 W 1545 W/1845 W		
Refrigeration factor $\varepsilon = \dot{Q}_K/P_{el}$	L 35 L 35	2.1	2.1	2.2	2.0	1.9	1.9		
Refrigerant		R134a, 900 g							
Permissible operating pressure p. max.		28 bar							
Operating temperature and setting range		+20°C to +50°C							
Protection category		NEMA 4X							
Weight		80 kg	87 kg	80 kg	83 kg	90 kg	83 kg		
Air throughput of fans	External circuit	640 m <sup>3</sup> /h			710 m <sup>3</sup> /h				
	Internal circuit	550 m <sup>3</sup> /h			640 m <sup>3</sup> /h				
Temperature control		e-Comfort controller (factory setting +35°C)							
<b>Accessories</b>	<b>Packs of</b>								
Door-operated switch	1	4127.010	4127.010	4127.010	4127.010	4127.010	4127.010	496	
SK BUS system	1	3124.100	3124.100	3124.100	3124.100	3124.100	3124.100	295	
RiDiag II	1	3159.100	3159.100	3159.100	3159.100	3159.100	3159.100	347	
Interface board	1	3124.200	3124.200	3124.200	3124.200	3124.200	3124.200	295	
Condensate hose	1	3301.612	3301.612	3301.612	3301.612	3301.612	3301.612	303	

<sup>1)</sup> Motor circuit breaker. <sup>2)</sup> Transformer protection switch.

Delivery times available on request. Special voltages available on request. We reserve the right to make technical modifications.

## TopTherm "Blue e", Ex cooling units for zone 22 (dust); useful cooling output 500/1000/1500 W



Model No. SK		3303.530	3304.530	3304.560	3305.530	3305.560	Page	
Material		Sheet steel						
Colour		RAL 7035						
Rated operating voltage V, Hz		230, 1~, 50/60	230, 50/60	400, 3~, 50/460, 3~, 60	230, 50/60	400, 3~, 50/460, 3~, 60		
Dimensions mm	W x H x D	280 x 550 x 210	400 x 950 x 260			400 x 950 x 260		
<b>Useful cooling output <math>\dot{Q}_K</math> to DIN 3168</b>	<b>L 35 L 35 L 35 L 50</b>	<b>500 W/610 W 280 W/350 W</b>	<b>1000 W/1450 W 1050 W/1100 W</b>	<b>1000 W/1460 W 880 W/990 W</b>	<b>1500 W/1510 W 1150 W/1200 W</b>	<b>1500 W/1510 W 1230 W/1250 W</b>		
Rated current max.		2.6 A/2.6 A	3.9 A/4.3 A	2.1 A/2.2 A	5.4 A/6.0 A	2.3 A/2.6 A		
Start-up current		5.1 A/6.4 A	12.0 A/14.0 A	11.5 A/12.7 A	22.0 A/24.0 A	12.2 A/11.3 A		
Pre-fuse T		10.0 A	10.0 A/10.0 A	6.3 A – 10.0 A <sup>1)</sup>	16.0 A/16.0 A	6.3 A – 10.0 A <sup>1)</sup>		
Power consumption $P_{el}$ to DIN 3168	L 35 L 35 L 35 L 50	360 W/380 W 420 W/390 W	640 W/720 W 750 W/850 W	670 W/820 W 760 W/930 W	870 W/980 W 1030 W/1150 W	820 W/1000 W 980 W/1170 W		
Refrigeration factor $\varepsilon = \dot{Q}_K/P_{el}$	L 35 L 35	1.4	1.4	1.7	1.7	1.8		
Refrigerant		R134a, 170 g	R134a, 325 g	R134a, 325 g	R134a, 600 g			
Permissible operating pressure p. max.		28 bar	25 bar					
Operating temperature and setting range		+20°C to +50°C						
Protection category	External circuit	IP 54						
	Internal circuit	IP 54						
Weight		17 kg	39 kg	41 kg				
Air throughput of fans	External circuit	345 m <sup>3</sup> /h	900 m <sup>3</sup> /h			800 m <sup>3</sup> /h		
	Internal circuit	310 m <sup>3</sup> /h	600 m <sup>3</sup> /h					
Temperature control		e-Comfort controller (factory setting +35°C)						
<b>Accessories</b>	<b>Packs of</b>							
Filter mats	3	3286.300	3286.400	3286.400	3286.400	3286.400	299	
Door-operated switch	1	4127.010	4127.010	4127.010	4127.010	4127.010	496	
Digital temperature display/thermostat	1	3114.200	3114.200	3114.200	3114.200	3114.200	293	
Condensate hose	1	3301.612	3301.612	3301.612	3301.612	3301.612	303	

<sup>1)</sup> Motor circuit breaker.  
Without electric condensate evaporation.

Delivery times available on request. We reserve the right to make technical modifications.

# Roof-mounted cooling units



Climate control accessories Page 291 Software & services Page 333 RiDiag II Page 347

## Technical specifications:

- Permissible operating pressure p. max.: 25 bar
- Duty cycle: 100%
- Type of connection: Plug-in terminal strip

## Protection category:

- External circuit IP 34 to IEC 60 529
- Internal circuit IP 54 to IEC 60 529

## Supply includes:

- Nano-coated condenser
- Integral electric condensate evaporation
- Fully wired ready for connection
- Drilling template
- Assembly parts



## Accessories:

Roof plate for TS 8 with mounting cut-out, see page 296.

**New: TopTherm roof-mounted cooling unit,** useful cooling output 1100/3000 W, for office and IT applications with targeted air routing, see page 246. Detailed drawing and technical information can be found on the Internet.

## Approvals:

Available on the Internet.

## Detailed drawing:

Available on the Internet.

## Performance diagrams:

Available on the Internet.

## TopTherm “Blue e”, useful cooling output 500 W



Model No. SK	3382.500	3382.600 <sup>1)</sup>	3382.510	3382.610 <sup>1)</sup>	Page
Material	Sheet steel	Stainless steel	Sheet steel	Stainless steel	
Colour	RAL 7035	–	RAL 7035	–	
Rated operating voltage V, Hz	230, 1~, 50/60		115, 1~, 50/60		
Dimensions mm	W x H x D 597 x 417 x 380				
<b>Useful cooling output <math>\dot{Q}_k</math> to DIN 3168</b>	<b>L 35 L 35</b>	<b>500 W/586 W</b>	<b>L 35 L 50</b>	<b>273 W/429 W</b>	
Rated current max.	2.3 A/2.6 A		4.1 A/5.4 A		
Start-up current	9.1 A/8.8 A		18.2 A/15.9 A		
Pre-fuse T	10.0 A		6.3 A – 10.0 A <sup>2)</sup>		
Power consumption $P_{el}$ to DIN 3168	L 35 L 35	302 W/347 W	L 35 L 50	312 W/357 W	
Refrigeration factor $\epsilon = \dot{Q}_k/P_{el}$	L 35 L 35	1.6		352 W/422 W	
Refrigerant	R134a, 300 g				
Operating temperature and setting range	+20°C to +55°C				
Weight	30 kg		35 kg		
Air throughput of fans (unimpeded air flow)	External circuit	800 m <sup>3</sup> /h	Internal circuit	170 m <sup>3</sup> /h	
Temperature control	e-Comfort controller (factory setting +35°C)				
<b>Accessories</b>	<b>Packs of</b>				
Filter mats	3	3286.500	3286.500	3286.500	299
Metal filters	1	3286.510	3286.510	3286.510	300
Quick-change frame	1	3286.700	3286.700	3286.700	297
Door-operated switch	1	4127.010	4127.010	4127.010	496
SK BUS system	1	3124.100	3124.100	3124.100	295
Interface board	1	3124.200	3124.200	3124.200	295
Air duct system	1	3286.870	3286.870	3286.870	291
Stoppers	2	3286.780	3286.780	3286.780	292
Condensate hose	1	3301.612	3301.612	3301.612	303

<sup>1)</sup> Extended delivery times. <sup>2)</sup> Transformer protection switch.  
Special voltages available on request. We reserve the right to make technical modifications.

# Roof-mounted cooling units



## TopTherm "Blue e", useful cooling output 750 W

Model No. SK		3359.500	3359.600 <sup>1)</sup>	3359.510	3359.610 <sup>1)</sup>	3359.540	3359.640 <sup>1)</sup>	Page
Material		Sheet steel	Stainless steel	Sheet steel	Stainless steel	Sheet steel	Stainless steel	
Colour		RAL 7035	–	RAL 7035	–	RAL 7035	–	
Rated operating voltage V, Hz		230, 1~, 50/60		115, 1~, 50/60		400, 2~, 50/60		
Dimensions mm	W x H x D	597 x 417 x 380						
<b>Useful cooling output <math>\dot{Q}_K</math> to DIN 3168</b>	<b>L 35 L 35 L 35 L 50</b>	<b>750 W/625 W 304 W/368 W</b>						
Rated current max.		2.8 A/3.7 A		5.6 A/7.4 A		1.6 A/2.1 A		
Start-up current		9.2 A/9.0 A		18.4 A/18.0 A		5.4 A/5.2 A		
Pre-fuse T		10.0 A		11.0 A – 16.0 A <sup>2)</sup>		6.3 A – 10.0 A <sup>2)</sup>		
Power consumption $P_{el}$ to DIN 3168	L 35 L 35 L 35 L 50	401 W/494 W 444 W/536 W		411 W/509 W 454 W/526 W				
Refrigeration factor $\varepsilon = \dot{Q}_K/P_{el}$	L 35 L 35	1.8						
Refrigerant		R134a, 300 g						
Operating temperature and setting range		+20°C to +55°C						
Weight		32 kg		37 kg				
Air throughput of fans (unimpeded air flow)	External circuit Internal circuit	800 m <sup>3</sup> /h 585 m <sup>3</sup> /h						
Temperature control		e-Comfort controller (factory setting +35°C)						
<b>Accessories</b>	Packs of							
Filter mats	3	3286.500	3286.500	3286.500	3286.500	3286.500	3286.500	299
Metal filters	1	3286.510	3286.510	3286.510	3286.510	3286.510	3286.510	300
Quick-change frame	1	3286.700	3286.700	3286.700	3286.700	3286.700	3286.700	297
Door-operated switch	1	4127.010	4127.010	4127.010	4127.010	4127.010	4127.010	496
SK BUS system	1	3124.100	3124.100	3124.100	3124.100	3124.100	3124.100	295
Interface board	1	3124.200	3124.200	3124.200	3124.200	3124.200	3124.200	295
Air duct system	1	3286.870	3286.870	3286.870	3286.870	3286.870	3286.870	291
Stoppers	2	3286.780	3286.780	3286.780	3286.780	3286.780	3286.780	292
Condensate hose	1	3301.612	3301.612	3301.612	3301.612	3301.612	3301.612	303

<sup>1)</sup> Extended delivery times. <sup>2)</sup> Transformer protection switch.  
Special voltages available on request. We reserve the right to make technical modifications.

## TopTherm "Blue e", useful cooling output 1000 W



Model No. SK		3383.500	3383.600 <sup>1)</sup>	3383.510	3383.610 <sup>1)</sup>	3383.540 <sup>1)</sup>	3383.640	Page
Material		Sheet steel	Stainless steel	Sheet steel	Stainless steel	Sheet steel	Stainless steel	
Colour		RAL 7035	–	RAL 7035	–	RAL 7035	–	
Rated operating voltage V, Hz		230, 1~, 50/60 <sup>3)</sup>		115, 1~, 50/60 <sup>3)</sup>		400, 2~, 50/60 <sup>3)</sup>		
Dimensions mm	W x H x D	597 x 417 x 475						
<b>Useful cooling output <math>\dot{Q}_K</math> to DIN 3168</b>	<b>L 35 L 35 L 35 L 50</b>	<b>1000 W/1088 W 709 W/807 W</b>						
Rated current max.		2.9 A/3.9 A		5.6 A/7.7 A		2.9 A/3.9 A		
Start-up current		8.8 A/10.1 A		14.4 A/15.8 A		4.6 A/5.7 A		
Pre-fuse T		10.0 A		11.0 A – 16.0 A <sup>2)</sup>		6.3 A – 10.0 A <sup>2)</sup>		
Power consumption $P_{el}$ to DIN 3168	L 35 L 35 L 35 L 50	426 W/514 W 485 W/606 W		456 W/524 W 495 W/616 W				
Refrigeration factor $\varepsilon = \dot{Q}_K/P_{el}$	L 35 L 35	2.3		2.2				
Refrigerant		R134a, 650 g						
Operating temperature and setting range		+20°C to +55°C						
Weight		40 kg		46 kg				
Air throughput of fans (unimpeded air flow)	External circuit Internal circuit	1600 m <sup>3</sup> /h 491 m <sup>3</sup> /h						
Temperature control		e-Comfort controller (factory setting +35°C)						
<b>Accessories</b>	Packs of							
Filter mats	3	3286.500	3286.500	3286.500	3286.500	3286.500	3286.500	299
Metal filters	1	3286.510	3286.510	3286.510	3286.510	3286.510	3286.510	300
Quick-change frame	1	3286.800	3286.800	3286.800	3286.800	3286.800	3286.800	297
Door-operated switch	1	4127.010	4127.010	4127.010	4127.010	4127.010	4127.010	496
SK BUS system	1	3124.100	3124.100	3124.100	3124.100	3124.100	3124.100	295
Interface board	1	3124.200	3124.200	3124.200	3124.200	3124.200	3124.200	295
Air duct system	1	3286.870	3286.870	3286.870	3286.870	3286.870	3286.870	291
Stoppers	2	3286.880	3286.880	3286.880	3286.880	3286.880	3286.880	292
Condensate hose	1	3301.612	3301.612	3301.612	3301.612	3301.612	3301.612	303

<sup>1)</sup> Extended delivery times. <sup>2)</sup> Transformer protection switch. <sup>3)</sup>  $T_u$  max = 53°C/60 Hz.  
Special voltages available on request. We reserve the right to make technical modifications.

# Roof-mounted cooling units

TopTherm "Blue e", useful cooling output 1100/3000 W, especially for office and IT applications



Model No. SK	3273.500		3273.515 <sup>1)</sup>	3301.800		Page
Application areas	Office application			IT application		
Material	Sheet steel					
Colour	RAL 7035					
Rated operating voltage V, Hz	230, 1~, 50/60		115, 1~, 50/60	230, 1~, 50		
Dimensions mm	W x H x D		597 x 417 x 475		597 x 417 x 895	
Useful cooling output $\dot{Q}_K$ to DIN 3168	L 35 L 35 L 35 L 50	1100 W/1200 W 850 W/870 W		3000 W 3200 W	L 25 L 35 L 35 L 45	
Rated current max.	5.2 A/5.4 A		11.0 A/11.5 A	10.4 A		
Start-up current	15.5 A/16.5 A		32.0 A/35.0 A	36.0 A		
Pre-fuse T	10.0 A		11.0 A – 16.0 A <sup>2)</sup>	Air circuit-breaker 16.0 A		
Power consumption $P_{el}$ to DIN 3168	L 35 L 35 L 35 L 50	760 W/780 W 830 W/970 W		790 W/810 W 860 W/1010 W	1820 W 2325 W	L 25 L 35 L 35 L 45
Refrigeration factor $\varepsilon = \dot{Q}_K/P_{el}$	L 35 L 35		1.4		1.6	
Refrigerant	R134a, 700 g					
Operating temperature and setting range	+20°C to +50°C			+20°C to +45°C		
Weight	42 kg		47 kg	72 kg		
Air throughput of fans (unimpeded air flow)	External circuit		1760 m <sup>3</sup> /h		2000 m <sup>3</sup> /h	
	Internal circuit		440 m <sup>3</sup> /h		1450 m <sup>3</sup> /h	
Temperature control	e-Comfort controller (factory setting +35°C)					
<b>Accessories</b>	Packs of					
Filter mats	3	3286.500	3286.500	3286.500	3286.600	299
Metal filters	1	3286.510	3286.510	3286.510	3286.610	300
Quick-change frame	1	3286.700	3286.700	3286.700	3286.800	297
Door-operated switch	1	4127.010	4127.010	4127.010	4127.010	496
SK BUS system	1	3124.100	3124.100	3124.100	3124.100	295
Interface board	1	3124.200	3124.200	3124.200	3124.200	295
Air duct system	1	3286.870	3286.870	3286.870	3286.970	291
Stoppers	2	3286.880	3286.880	3286.880	3286.980	292
Condensate hose	1	3301.612	3301.612	3301.612	3301.612	303

<sup>1)</sup> Extended delivery times. <sup>2)</sup> Transformer protection switch.

In order to avoid increased condensation, we recommend enclosures with a protection category of at least IP 54. Special voltages available on request. We reserve the right to make technical modifications.

## TopTherm "Blue e", useful cooling output 1500 W



Model No. SK	3384.500		3384.600 <sup>1)</sup>	3384.510	3384.610 <sup>1)</sup>	3384.540	3384.640 <sup>1)</sup>	Page
Material	Sheet steel		Stainless steel	Sheet steel	Stainless steel	Sheet steel	Stainless steel	
Colour	RAL 7035		–	RAL 7035	–	RAL 7035	–	
Rated operating voltage V, Hz	230, 1~, 50/60 <sup>3)</sup>			115, 1~, 50/60 <sup>3)</sup>		400, 2~, 50/60 <sup>3)</sup>		
Dimensions mm	W x H x D		597 x 417 x 475					
Useful cooling output $\dot{Q}_K$ to DIN 3168	L 35 L 35 L 35 L 50	1500 W/1637 W 1207 W/1308 W						
Rated current max.	4.2 A/4.9 A		8.7 A/10.1 A		2.5 A/2.9 A			
Start-up current	14.7 A/13.6 A		27.2 A/23.2 A		8.7 A/7.6 A			
Pre-fuse T	10.0 A		14.0 A – 20.0 A <sup>2)</sup>		6.3 A – 10.0 A <sup>2)</sup>			
Power consumption $P_{el}$ to DIN 3168	L 35 L 35 L 35 L 50	641 W/743 W 741 W/857 W		666 W/757 W 775 W/899 W				
Refrigeration factor $\varepsilon = \dot{Q}_K/P_{el}$	L 35 L 35		2.4		2.3			
Refrigerant	R134a, 500 g							
Operating temperature and setting range	+20°C to +55°C							
Weight	41 kg		47 kg					
Air throughput of fans (unimpeded air flow)	External circuit		1600 m <sup>3</sup> /h					
	Internal circuit		491 m <sup>3</sup> /h					
Temperature control	e-Comfort controller (factory setting +35°C)							
<b>Accessories</b>	Packs of							
Filter mats	3	3286.500	3286.500	3286.500	3286.500	3286.500	3286.500	299
Metal filters	1	3286.510	3286.510	3286.510	3286.510	3286.510	3286.510	300
Quick-change frame	1	3286.800	3286.800	3286.800	3286.800	3286.800	3286.800	297
Door-operated switch	1	4127.010	4127.010	4127.010	4127.010	4127.010	4127.010	496
SK BUS system	1	3124.100	3124.100	3124.100	3124.100	3124.100	3124.100	295
Interface board	1	3124.200	3124.200	3124.200	3124.200	3124.200	3124.200	295
Air duct system	1	3286.870	3286.870	3286.870	3286.870	3286.870	3286.870	291
Stoppers	2	3286.880	3286.880	3286.880	3286.880	3286.880	3286.880	292
Condensate hose	1	3301.612	3301.612	3301.612	3301.612	3301.612	3301.612	303

<sup>1)</sup> Extended delivery times. <sup>2)</sup> Transformer protection switch. <sup>3)</sup>  $T_u$  max = 53°C/60 Hz.

Special voltages available on request. We reserve the right to make technical modifications.

# Roof-mounted cooling units



## TopTherm "Blue e", useful cooling output 2000 W

Model No. SK		3385.500	3385.600 <sup>1)</sup>	3385.510	3385.610 <sup>1)</sup>	3385.540	3385.640 <sup>1)</sup>	Page
Material		Sheet steel	Stainless steel	Sheet steel	Stainless steel	Sheet steel	Stainless steel	
Colour		RAL 7035	–	RAL 7035	–	RAL 7035	–	
Rated operating voltage V, Hz		230, 1~, 50/60 <sup>3)</sup>		115, 1~, 50/60 <sup>3)</sup>		400, 2~, 50/60 <sup>3)</sup>		
Dimensions mm	W x H x D	597 x 417 x 475						
<b>Useful cooling output <math>\dot{Q}_K</math> to DIN 3168</b>	<b>L 35 L 35 L 35 L 50</b>	<b>2000 W/2030 W 1454 W/1547 W</b>		<b>2000 W/2140 W 1409 W/1511 W</b>				
Rated current max.		5.9 A/6.3 A		13.3 A/13.5 A		3.5 A/3.7 A		
Start-up current		19.7 A/17.9 A		42.2 A/31.1 A		11.7 A/11.7 A		
Pre-fuse T		10.0 A		14.0 A – 20.0 A <sup>2)</sup>		6.3 A – 10.0 A <sup>2)</sup>		
Power consumption $P_{el}$ to DIN 3168	L 35 L 35 L 35 L 50	970 W/1155 W 1081 W/1511 W		1020 W/1235 W 1441 W/1310 W				
Refrigeration factor $\varepsilon = \dot{Q}_K/P_{el}$	L 35 L 35	2.1		2.0				
Refrigerant		R134a, 900 g						
Operating temperature and setting range		+20°C to +55°C						
Weight		42 kg		48 kg				
Air throughput of fans (unimpeded air flow)	External circuit Internal circuit	2100 m <sup>3</sup> /h 657 m <sup>3</sup> /h						
Temperature control		e-Comfort controller (factory setting +35°C)						
<b>Accessories</b>	<b>Packs of</b>							
Filter mats	3	3286.500	3286.500	3286.500	3286.500	3286.500	3286.500	299
Metal filters	1	3286.510	3286.510	3286.510	3286.510	3286.510	3286.510	300
Quick-change frame	1	3286.800	3286.800	3286.800	3286.800	3286.800	3286.800	297
Door-operated switch	1	4127.010	4127.010	4127.010	4127.010	4127.010	4127.010	496
SK BUS system	1	3124.100	3124.100	3124.100	3124.100	3124.100	3124.100	295
Interface board	1	3124.200	3124.200	3124.200	3124.200	3124.200	3124.200	295
Air duct system	1	3286.870	3286.870	3286.870	3286.870	3286.870	3286.870	291
Stoppers	2	3286.880	3286.880	3286.880	3286.880	3286.880	3286.880	292
Condensate hose	1	3301.612	3301.612	3301.612	3301.612	3301.612	3301.612	303

<sup>1)</sup> Extended delivery times. <sup>2)</sup> Transformer protection switch. <sup>3)</sup>  $T_u$  max = 53°C/60 Hz.  
Special voltages available on request. We reserve the right to make technical modifications.

## TopTherm "Blue e", useful cooling output 3000 W/4000 W



Model No. SK		3386.540	3386.640 <sup>1)</sup>	3387.540	3387.640 <sup>1)</sup>	Page
Material		Sheet steel	Stainless steel	Sheet steel	Stainless steel	
Colour		RAL 7035	–	RAL 7035	–	
Rated operating voltage V, Hz		400, 3~, 50/460, 3~, 60				
Dimensions mm	W x H x D	796 x 470 x 580				
<b>Useful cooling output <math>\dot{Q}_K</math> to DIN 3168</b>	<b>L 35 L 35 L 35 L 50</b>	<b>3000 W/3300 W 2200 W/2500 W</b>		<b>4000 W/4200 W 3250 W/3490 W</b>		
Rated current max.		3.4 A/3.4 A		3.9 A/3.9 A		
Start-up current		8.0 A/9.0 A		17.0 A/19.0 A		
Pre-fuse T		Motor circuit breaker 6.3 A – 10.0 A				
Power consumption $P_{el}$ to DIN 3168	L 35 L 35 L 35 L 50	1190 W/1500 W 1440 W/1780 W		1630 W/2070 W 1880 W/2350 W		
Refrigeration factor $\varepsilon = \dot{Q}_K/P_{el}$	L 35 L 35	2.3				
Refrigerant		R134a, 1600 g				
Operating temperature and setting range		+20°C to +55°C				
Weight		70 kg		77 kg		
Air throughput of fans (unimpeded air flow)	External circuit Internal circuit	3450 m <sup>3</sup> /h 1280 m <sup>3</sup> /h		3870 m <sup>3</sup> /h 1420 m <sup>3</sup> /h		
Temperature control		e-Comfort controller (factory setting +35°C)				
<b>Accessories</b>	<b>Packs of</b>					
Filter mats	3	3286.600	3286.600	3286.600	3286.600	299
Metal filters	1	3286.610	3286.610	3286.610	3286.610	300
Quick-change frame	1	3286.900	3286.900	3286.900	3286.900	297
Door-operated switch	1	4127.010	4127.010	4127.010	4127.010	496
SK BUS system	1	3124.100	3124.100	3124.100	3124.100	295
Interface board	1	3124.200	3124.200	3124.200	3124.200	295
Air duct system	1	3286.970	3286.970	3286.970	3286.970	291
Stoppers	2	3286.980	3286.980	3286.980	3286.980	292
Condensate hose	1	3301.612	3301.612	3301.612	3301.612	303

<sup>1)</sup> Extended delivery times.  
Special voltages available on request. We reserve the right to make technical modifications.

# Modular climate control concept



Climate control accessories Page 291 TS 8 enclosures Page 69 Software & services Page 333

**Colour:**  
RAL 7035

**Protection category:**  
– External circuit IP 34 to IEC 60 529  
– Internal circuit IP 54 to IEC 60 529

**Supply includes:**  
– Cooling module prepared for installation in section door  
– Nano-coated condenser  
– Integral electric condensate evaporation

**! Also required:**

- Section door, fits TS 8 enclosures, 600, 800, 1200 mm widths and 1800, 2000 mm heights, see page 249.
- Base/plinth, 100 or 200 mm high, see page 361.

**Approvals:**  
Available on the Internet.

**Detailed drawing:**  
Available on the Internet.

**Performance diagrams:**  
Available on the Internet.

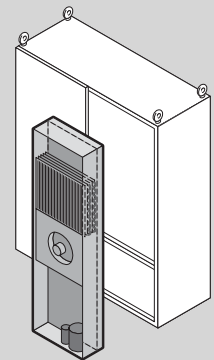

## Cooling modules “Blue e”, 1500/2500 W useful cooling output



Model No. SK with Comfort controller	3307.700	3307.710	3307.740	3310.700	3310.710	3310.740	Page
Rated operating voltage V, Hz	230, 1~, 50/60	115, 1~, 50/60	400, 3~, 50/460, 3~, 60	230, 1~, 50/60	115, 1~, 50/60	400, 3~, 50/460, 3~, 60	
<b>Useful cooling output <math>\dot{Q}_k</math> to DIN 3168</b>	<b>L 35 L 35 L 35 L 50</b>	<b>1500 W/1550 W 850 W/900 W</b>	<b>1500 W/1550 W 930 W/950 W</b>	<b>2500 W/2520 W 1620 W/1730 W</b>		<b>2500 W/2500 W 1760 W/1800 W</b>	
Rated current max.	6.0 A/6.1 A	11.2 A/11.8 A	2.5 A/2.7 A	7.6 A/9.4 A	17.3 A/19.0 A	3.5 A/3.7 A	
Start-up current	22.0 A/24.0 A	36.0 A/39.0 A	8.5 A/9.2 A	22.0 A/24.0 A	36.0 A/39.0 A	13.0 A/14.0 A	
Pre-fuse T	16.0 A/16.0 A	11.0 A – 16.0 A <sup>3)</sup>	6.3 A – 10.0 A <sup>1)</sup>	16.0 A/16.0 A	18.0 A – 25.0 A <sup>3)</sup>	6.3 A – 10.0 A <sup>1)</sup>	
Power consumption $P_{el}$ to DIN 3168	L 35 L 35 L 35 L 50	850 W/1050 W 1000 W/1150 W	870 W/1080 W 1070 W/1180 W	790 W/1000 W 900 W/1100 W	1310 W/1520 W 1480 W/1850 W	1360 W/1570 W 1530 W/1900 W	1130 W/1480 W 1400 W/1750 W
Refrigeration factor $\varepsilon = \dot{Q}_k/P_{el}$	L 35 L 35	1.8	1.7	1.9	1.9	1.8	2.2
Refrigerant	R134a, 700 g			R134a, 1175 g			
Operating temperature and setting range	+20°C to +55°C						
Weight <sup>2)</sup>	68 kg	72 kg	68 kg	73 kg	78 kg	72 kg	
Air throughput of fans (unimpeded air flow)	External circuit	1100 m <sup>3</sup> /h		1100 m <sup>3</sup> /h			
	Internal circuit	600 m <sup>3</sup> /h		1100 m <sup>3</sup> /h			
Temperature control	Comfort controller (factory setting +35°C)						
<b>Accessories</b>	Packs of						
Door-operated switch	1	4127.010	4127.010	4127.010	4127.010	4127.010	496
SK BUS system	1	3124.100	3124.100	3124.100	3124.100	3124.100	295
RiDiag II	1	3159.100	3159.100	3159.100	3159.100	3159.100	347
Interface board	1	3124.200	3124.200	3124.200	3124.200	3124.200	295

Special voltages available on request. We reserve the right to make technical modifications.

<sup>1)</sup> Motor circuit breaker

<sup>2)</sup> Includes section door weight

<sup>3)</sup> Transformer protection switch



# Modular climate control concept

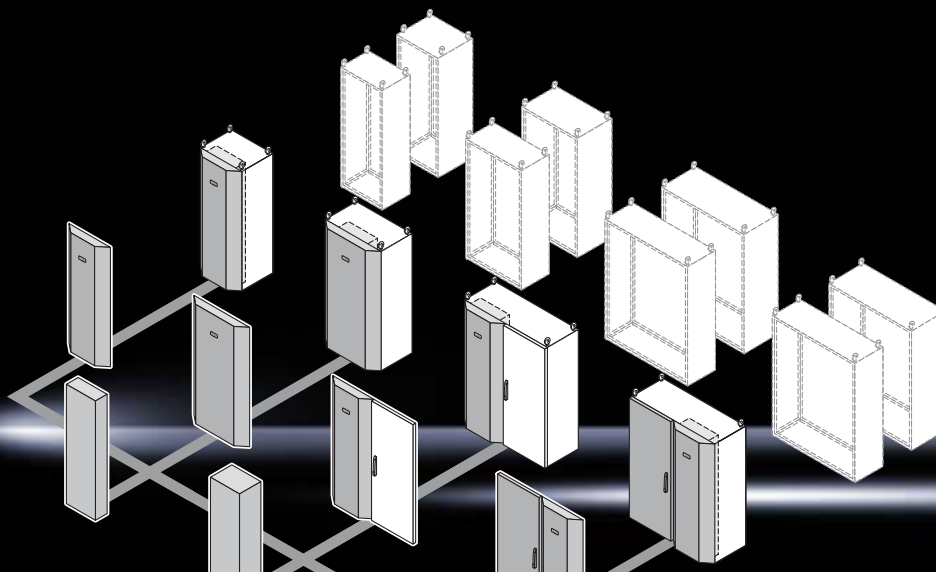

Climate control accessories Page 291 TS 8 enclosures Page 69 Software & services Page 333

**Colour:**  
RAL 7035

**Supply includes:**

- Section door without pre-configured cooling module
- TS 8 hinges, door opening angle approx. 110°

**Note for 1200 mm wide TS 8 enclosures:**

- With the unit positioned on the right, one pack consists of a section door for installing in the right-hand half of the enclosure plus a special lockable door for the left-hand half.
- With the device positioned on the "left", one pack consists of a section door for installing in the left-hand half of the enclosure. The existing lockable door on the right may be used.



**Also required:**

- Cooling module, see page 248.
- Base/plinth, 100 or 200 mm high, see page 361.

**Approvals:**

Available on the Internet.

**Detailed drawing:**

Available on the Internet.

**Performance diagrams:**

Available on the Internet.

## Section doors for installing cooling modules

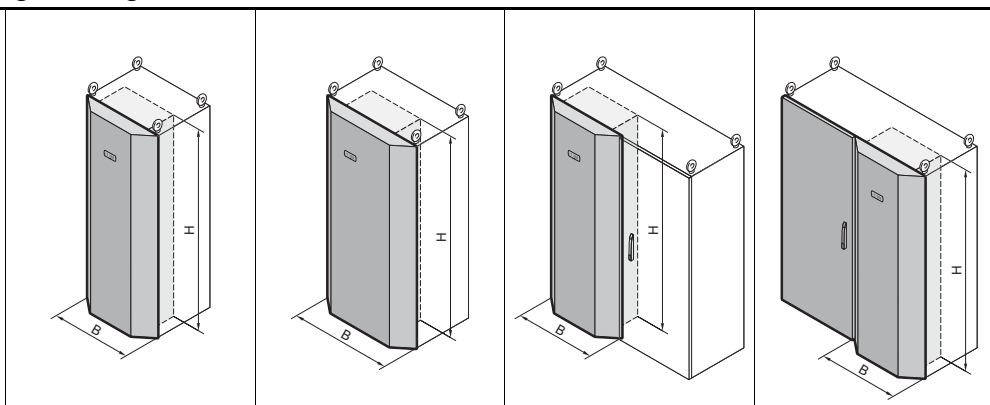

Model No. SK		3300.040	3300.050	3300.060	3300.070	3300.080	3300.090	3300.110	3300.120
Dimensions to fit TS enclosures	Height mm	1800	2000	1800	2000	1800	2000	1800	2000
Dimensions to fit TS enclosures	Width (B) mm	600		800		1200 (unit positioned on the left)		1200 (unit positioned on the right)	
<b>Accessories</b>		Packs of							
Metal filters		1	3284.210	3284.210		3284.210		3284.210	

All SK 3307.700/.710/.740 or 3310.700/.710/.740 cooling module models, see page 248, can be integrated into one of the section doors mentioned above.



# Liquid cooling

## Air/water heat exchangers

Roof-mounted, water-carrying parts CuAl .....	2500 W .....	252
Roof-mounted, water-carrying parts CuAl .....	4000 W .....	253
Roof-mounted, water-carrying parts V4A (1.4571) .....	1875 W .....	253
Roof-mounted, water-carrying parts V4A (1.4571) .....	3000 W .....	254
Wall-mounted .....	300/600/1250 W .....	255
Wall-mounted, water-carrying parts CuAl .....	500 W .....	256
Wall-mounted, water-carrying parts CuAl .....	1000 W .....	256
Wall-mounted, water-carrying parts CuAl .....	2000 W .....	257
Wall-mounted, water-carrying parts CuAl .....	3000 W .....	257
Wall-mounted, water-carrying parts CuAl .....	5000 W .....	258
Wall-mounted .....	7000 W .....	258
Wall-mounted, water-carrying parts V4A (1.4571) .....	500 W .....	259
Wall-mounted, water-carrying parts V4A (1.4571) .....	750 W .....	259
Wall-mounted, water-carrying parts V4A (1.4571) .....	1750 W .....	260
Wall-mounted, water-carrying parts V4A (1.4571) .....	2500 W .....	260
Wall-mounted, water-carrying parts V4A (1.4571) .....	4000 W .....	261

## Cold Plate

Cold Plate incl. T channel for frequency converters ..	2500/3000 W .....	262
Accessories for Cold Plate .....		263

## Chillers for water

TopTherm .....	1/1.5 kW .....	264
TopTherm .....	3/4.5/6 kW .....	265
TopTherm, for wall mounting .....	1/2.5/4 kW .....	266
TopTherm .....	8 – 40 kW .....	267
In a floor-standing enclosure .....	2.1 – 7.7 kW .....	268
In a floor-standing enclosure .....	10 – 25 kW .....	269
In a floor-standing enclosure .....	32 – 59 kW .....	269



# Air/water heat exchangers



Climate control accessories Page 291 Recooling systems Page 264 Software & Services Page 333

**Colour:**  
RAL 7035

**Supply includes:**

- Fully wired ready for connection, with connector
- Drilling template, sealing mat and assembly parts



**Also required:**

Cooling water system such as recooling systems, from page 264.

**Approvals:**

Available on the Internet.

**Detailed drawing:**

Available on the Internet.

**Performance diagrams:**

Available on the Internet.

## Roof-mounted, useful cooling output 2500 W, water-carrying parts CuAl

Model No. SK	3209.500	3209.100	Page
Thermostat (factory setting +35°C)	e-Comfort controller	■	–
	Basic controller	–	■
<b>Useful cooling output</b>	<b>L 35 W 10, 400 l/h</b>	<b>2500 W</b>	
Rated operating voltage V, Hz	230, 50/60		
Dimensions mm	W x H x D 597 x 417 x 475		
Rated current max.	0.40 A/0.48 A		
Pre-fuse T	4.0 A		
Cooling medium	Water (for specifications see Internet; user manual)		
Water inlet temperature	> +1°C to +30°C		
Permissible operating pressure p. max.	1 to 10 bar		
Operating temperature and setting range	+1°C to +70°C		
Protection category to IEC 60 529	IP 55 <sup>1)</sup>		
Duty cycle	100%		
Type of connection	Plug-in terminal strip		
Weight	23.5 kg		
Air throughput of the fans (unimpeded air flow)	1030 m <sup>3</sup> /h		
<b>Accessories</b>	Packs of		
Door-operated switch	1	4127.010	4127.010 496
SK BUS system	1	3124.100	– 295
Interface board	1	3124.200	– 295
Air duct system	1	3286.870	3286.870 291
Stoppers	1	3286.880	3286.880 292
Condensate hose	1	3301.612	3301.612 303
Flow regulator valve	1		see page 304

<sup>1)</sup> IP 65 available on request.

Special voltages available on request. We reserve the right to make technical modifications.

# Air/water heat exchangers

## Roof-mounted, useful cooling output 4000 W, water-carrying parts CuAl

Model No. SK		3210.500	3210.100	3210.540 <sup>1)</sup>	3210.140 <sup>1)</sup>	Page
Thermostat (factory setting +35°C)	e-Comfort controller	■	–	■	–	
	Basic controller	–	■	–	■	
<b>Useful cooling output</b>	<b>L 35 W 10, 400 l/h</b>	<b>4000 W</b>				
Rated operating voltage V, Hz		230, 50/60		400, 2~, 50/60		
Dimensions mm	W x H x D	597 x 417 x 475				
Rated current max.		0.44 A/0.5 A		0.25 A/0.3 A		
Pre-fuse T		4.0 A				
Cooling medium		Water (for specifications see Internet; user manual)				
Water inlet temperature		> +1°C to +30°C				
Permissible operating pressure p. max.		1 to 10 bar				
Operating temperature and setting range		+1°C to +70°C				
Protection category to IEC 60 529		IP 55 <sup>2)</sup>				
Duty cycle		100%				
Type of connection		Plug-in terminal strip				
Weight		25.5 kg		29.5 kg		
Air throughput of the fans (unimpeded air flow)		925 m <sup>3</sup> /h				
<b>Accessories</b>		Packs of				
Door-operated switch	1	4127.010	4127.010	4127.010	4127.010	496
SK BUS system	1	3124.100	–	3124.100	–	295
Interface board	1	3124.200	–	3124.200	–	295
Air duct system	1	3286.870	3286.870	3286.870	3286.870	291
Stoppers	1	3286.880	3286.880	3286.880	3286.880	292
Condensate hose	1	3301.612	3301.612	3301.612	3301.612	303
Flow regulator valve	1	see page 304				

<sup>1)</sup> Extended delivery times.

<sup>2)</sup> IP 65 available on request.

Special voltages available on request. We reserve the right to make technical modifications.

## Roof-mounted, useful cooling output 1875 W, water-carrying parts V4A (1.4571)

Model No. SK		3209.504 <sup>1)</sup>	3209.104 <sup>1)</sup>	Page
Thermostat (factory setting +35°C)	e-Comfort controller	■	–	
	Basic controller	–	■	
<b>Useful cooling output</b>	<b>L 35 W 10, 400 l/h</b>	<b>1875 W</b>		
Rated operating voltage V, Hz		230, 50/60		
Dimensions mm	W x H x D	597 x 417 x 475		
Rated current max.		0.40 A/0.48 A		
Pre-fuse T		4.0 A		
Cooling medium		Water (for specifications see Internet; user manual)		
Water inlet temperature		> +1°C to +30°C		
Permissible operating pressure p. max.		1 to 10 bar		
Operating temperature and setting range		+1°C to +70°C		
Protection category to IEC 60 529		IP 55 <sup>2)</sup>		
Duty cycle		100%		
Type of connection		Plug-in terminal strip		
Weight		23.5 kg		
Air throughput of the fans (unimpeded air flow)		1030 m <sup>3</sup> /h		
<b>Accessories</b>		Packs of		
Door-operated switch	1	4127.010	4127.010	496
SK BUS system	1	3124.100	–	295
Interface board	1	3124.200	–	295
Air duct system	1	3286.870	3286.870	291
Stoppers	1	3286.880	3286.880	292
Condensate hose	1	3301.612	3301.612	303
Flow regulator valve	1	see page 304		

<sup>1)</sup> Extended delivery times.

<sup>2)</sup> IP 65 available on request.

Special voltages available on request. We reserve the right to make technical modifications.

# Air/water heat exchangers

Roof-mounted, useful cooling output 3000 W, water-carrying parts V4A (1.4571)

Model No. SK	3210.504 <sup>1)</sup>		3210.104 <sup>1)</sup>		Page
Thermostat (factory setting +35°C)	e-Comfort controller	■	-		
	Basic controller	-	■		
<b>Useful cooling output</b>	<b>L 35 W 10, 400 l/h</b>	<b>3000 W</b>			
Rated operating voltage V, Hz	230, 50/60				
Dimensions mm	W x H x D		597 x 417 x 475		
<hr/>					
Rated current max.	0.44 A/0.5 A				
Pre-fuse T	4.0 A				
Cooling medium	Water (for specifications see Internet; user manual)				
Water inlet temperature	> +1°C to +30°C				
Permissible operating pressure p. max.	1 to 10 bar				
Operating temperature and setting range	+1°C to +70°C				
Protection category to IEC 60 529	IP 55 <sup>2)</sup>				
Duty cycle	100%				
Type of connection	Plug-in terminal strip				
Weight	25.5 kg				
Air throughput of the fans (unimpeded air flow)	925 m <sup>3</sup> /h				
<hr/>					
<b>Accessories</b>	Packs of				
Door-operated switch	1	4127.010	4127.010		496
SK BUS system	1	3124.100	-		295
Interface board	1	3124.200	-		295
Air duct system	1	3286.870	3286.870		291
Stoppers	1	3286.880	3286.880		292
Condensate hose	1	3301.612	3301.612		303
Flow regulator valve	1			see page 304	

<sup>1)</sup> Extended delivery times.

<sup>2)</sup> IP 65 available on request.

Special voltages available on request. We reserve the right to make technical modifications.



## Rittal Norway

RITTAL AS  
 Postboks 258 · N-1401 Ski  
 Phone: +47 64 85 13 00 · Fax: +47 64 85 13 01  
 Besøksadresse: Regnbueveien 10  
 N-1405 Langhus  
 E-mail: rittal@rittal.no · www.rittal.no

# Air/water heat exchangers



Climate control accessories Page 291 Recooling systems Page 264 Software & Services Page 333

**Colour:**  
RAL 7035

**Supply includes:**  
– Fully wired ready for connection  
– Drilling template and assembly parts



**Also required:**

Cooling water system such as recooling systems, see from page 264.

**Approvals:**  
Available on the Internet.

**Detailed drawing:**  
Available on the Internet.

**Performance diagrams:**  
Available on the Internet.

## Wall-mounted, useful cooling output 300/600/1250 W

Model No. SK	3212.230	3212.115 <sup>1)</sup>	3212.024	3214.100	3215.100	Page
Temperature control	–			Thermostat-controlled magnetic valve		
<b>Useful cooling output</b>	<b>L 35 W 10, 200 l/h</b> <b>L 35 W 10, 400 l/h</b>	<b>300 W</b>		<b>600 W</b> <b>650 W</b>	<b>1250 W</b> <b>1300 W</b>	
Rated operating voltage V, Hz	230, 50/60	115, 50/60	24 V (DC)	230, 50/60		
Dimensions mm	W x H x D 150 x 300 x 85			200 x 500 x 100	200 x 950 x 100	
Rated current max.	0.11 A/0.13 A	0.23 A/0.24 A	1.20 A	0.17 A/0.18 A	0.38 A/0.4 A	
Pre-fuse T	2.0 A				4.0 A	
Cooling medium	Water (for specifications see Internet; user manual)					
Water inlet temperature	> +1°C to +30°C					
Permissible operating pressure p. max.	1 to 10 bar					
Operating temperature and setting range	+1°C to +70°C					
Protection category to IEC 60 529	IP 55 <sup>2)</sup>					
Duty cycle	100%					
Type of connection	Connection clamp			Terminal strip		
Weight	3 kg			7 kg	13 kg	
Air throughput of the fans (unimpeded air flow)	280 m <sup>3</sup> /h		250 m <sup>3</sup> /h	120 m <sup>3</sup> /h	200 m <sup>3</sup> /h	
Temperature monitoring	–			Internal thermostat, with change-over contact, switching load 16 A, setting range +20°C to +60°C (factory setting +35°C)		
<b>Accessories</b>	Packs of					
Digital temperature display/thermostat	1	3114.200	3114.200	3114.200	3114.200	293
Door-operated switch	1	4127.010	4127.010	4127.010	4127.010	496
Condensate hose	1	3301.610	3301.610	3301.610	3301.612	303
Flow regulator valve	1					see page 304

<sup>1)</sup> Extended delivery times.

<sup>2)</sup> IP 65 available on request.

Special voltages available on request. We reserve the right to make technical modifications.

# Air/water heat exchangers

## Wall-mounted, useful cooling output 500 W, water-carrying parts CuAl

Model No. SK	3363.500	3363.100	Page
Thermostat (factory setting +35°C)	e-Comfort controller ■ Basic controller –	– ■	
<b>Useful cooling output</b>	<b>L 35 W 10, 400 l/h</b>	<b>500 W</b>	
Rated operating voltage V, Hz	230, 1~, 50/60	230, 1~, 50/60	
Dimensions mm	W x H x D 280 x 550 x 120		

Rated current max.	0.17 A/0.18 A
Pre-fuse T	4.0 A
Cooling medium	Water (for specifications see Internet; user manual)
Water inlet temperature	+1°C to +30°C
Water connection	Quick-release fastener system
Permissible operating pressure p. max.	1 to 10 bar
Operating temperature and setting range	+1°C to +70°C
Protection category to IEC 60 529	IP 55 <sup>1)</sup>
Duty cycle	100%
Type of connection	Plug-in terminal strip
Weight	12 kg
Air throughput of the fans (unimpeded air flow)	270/320 m <sup>3</sup> /h

Accessories	Packs of			
Door-operated switch	1	4127.010	4127.010	496
SK BUS system	1	3124.100	–	295
Interface board	1	3124.200	–	295
Condensate hose	1	3301.612	3301.612	303
Threaded adaptor for quick-release fastener with G3/8" internal thread	2	3201.900	3201.900	304
Threaded adaptor for quick-release fastener with G3/8" external thread	2	3201.910	3201.910	304
Flow regulator valve	1		see page 304	

<sup>1)</sup> IP 65 available on request.

Special voltages available on request. We reserve the right to make technical modifications.

## Wall-mounted, useful cooling output 1000 W, water-carrying parts CuAl

Model No. SK	3364.500	3364.100	Page
Thermostat (factory setting +35°C)	e-Comfort controller ■ Basic controller –	– ■	
<b>Useful cooling output</b>	<b>L 35 W 10, 400 l/h</b>	<b>1000 W</b>	
Rated operating voltage V, Hz	230, 1~, 50/60		
Dimensions mm	W x H x D 280 x 550 x 120		

Rated current max.	0.2 A/0.19 A
Pre-fuse T	4.0 A
Cooling medium	Water (for specifications see Internet; user manual)
Water inlet temperature	+1°C to +30°C
Water connection	Quick-release fastener system
Permissible operating pressure p. max.	1 to 10 bar
Operating temperature and setting range	+1°C to +70°C
Protection category to IEC 60 529	IP 55 <sup>1)</sup>
Duty cycle	100%
Type of connection	Plug-in terminal strip
Weight	15 kg
Air throughput of the fans (unimpeded air flow)	270/320 m <sup>3</sup> /h

Accessories	Packs of			
Door-operated switch	1	4127.010	4127.010	496
SK BUS system	1	3124.100	–	295
Interface board	1	3124.200	–	295
Condensate hose	1	3301.612	3301.612	303
Threaded adaptor for quick-release fastener with G3/8" internal thread	2	3201.900	3201.900	304
Threaded adaptor for quick-release fastener with G3/8" external thread	2	3201.910	3201.910	304
Flow regulator valve	1		see page 304	

<sup>1)</sup> IP 65 available on request.

Special voltages available on request. We reserve the right to make technical modifications.



# Air/water heat exchangers

## Wall-mounted, useful cooling output 2000 W, water-carrying parts CuAl

Model No. SK	3373.500	3373.100	Page
Thermostat (factory setting +35°C)	e-Comfort controller ■	–	
	Basic controller –	■	
<b>Useful cooling output</b>	<b>L 35 W 10, 400 l/h</b>	<b>2000 W</b>	
Rated operating voltage V, Hz	230, 1~, 50/60		
Dimensions mm	W x H x D 400 x 950 x 140		
Rated current max.	0.38 A/0.43 A		
Pre-fuse T	4.0 A		
Cooling medium	Water (for specifications see Internet; user manual)		
Water inlet temperature	+1°C to +30°C		
Water connection	Quick-release fastener system		
Permissible operating pressure p. max.	1 to 10 bar		
Operating temperature and setting range	+1°C to +70°C		
Protection category to IEC 60 529	IP 55 <sup>1)</sup>		
Duty cycle	100%		
Type of connection	Plug-in terminal strip		
Weight	20 kg		
Air throughput of the fans (unimpeded air flow)	600/625 m <sup>3</sup> /h		
<b>Accessories</b>	Packs of		
Door-operated switch	1	4127.010	4127.010 496
SK BUS system	1	3124.100	– 295
Interface board	1	3124.200	– 295
Condensate hose	1	3301.612	3301.612 303
Threaded adaptor for quick-release fastener with G3/8" internal thread	2	3201.900	3201.900 304
Threaded adaptor for quick-release fastener with G3/8" external thread	2	3201.910	3201.910 304
Flow regulator valve	1		see page 304

<sup>1)</sup> IP 65 available on request.

Special voltages available on request. We reserve the right to make technical modifications.

## Wall-mounted, useful cooling output 3000 W, water-carrying parts CuAl

Model No. SK	3374.500	3374.100	Page
Thermostat (factory setting +35°C)	e-Comfort controller ■	–	
	Basic controller –	■	
<b>Useful cooling output</b>	<b>L 35 W 10, 400 l/h</b>	<b>3000 W</b>	
Rated operating voltage V, Hz	230, 1~, 50/60		
Dimensions mm	W x H x D 400 x 950 x 140		
Rated current max.	0.57 A/0.78 A		
Pre-fuse T	4.0 A		
Cooling medium	Water (for specifications see Internet; user manual)		
Water inlet temperature	+1°C to +30°C		
Water connection	Quick-release fastener system		
Permissible operating pressure p. max.	1 to 10 bar		
Operating temperature and setting range	+1°C to +70°C		
Protection category to IEC 60 529	IP 55 <sup>1)</sup>		
Duty cycle	100%		
Type of connection	Plug-in terminal strip		
Weight	20 kg		
Air throughput of the fans (unimpeded air flow)	700/730 m <sup>3</sup> /h		
<b>Accessories</b>	Packs of		
Door-operated switch	1	4127.010	4127.010 496
SK BUS system	1	3124.100	– 295
Interface board	1	3124.200	– 295
Condensate hose	1	3301.612	3301.612 303
Threaded adaptor for quick-release fastener with G3/8" internal thread	2	3201.900	3201.900 304
Threaded adaptor for quick-release fastener with G3/8" external thread	2	3201.910	3201.910 304
Flow regulator valve	1		see page 304

<sup>1)</sup> IP 65 available on request.

Special voltages available on request. We reserve the right to make technical modifications.

# Air/water heat exchangers

## Wall-mounted, useful cooling output 5000 W, water-carrying parts CuAl

Model No. SK	3375.500	3375.100	Page
Thermostat (factory setting +35°C)	e-Comfort controller ■	–	
	Basic controller –	■	
<b>Useful cooling output</b>	<b>L 35 W 10, 400 l/h</b>	<b>5000 W</b>	
Rated operating voltage V, Hz	230, 1~, 50/60		
Dimensions mm	W x H x D 450 x 1400 x 220		

Rated current max.	1.0 A/1.35 A	
Pre-fuse T	4.0 A	
Cooling medium	Water (for specifications see Internet; user manual)	
Water inlet temperature	+1°C to +30°C	
Water connection	Quick-release fastener system	
Permissible operating pressure p. max.	1 to 10 bar	
Operating temperature and setting range	+1°C to +70°C	
Protection category to IEC 60 529	IP 55 <sup>1)</sup>	
Duty cycle	100%	
Type of connection	Plug-in terminal strip	
Weight	56 kg	
Air throughput of the fans (unimpeded air flow)	2365/2,750 m <sup>3</sup> /h	

Accessories	Packs of			
Door-operated switch	1	4127.010	4127.010	496
SK BUS system	1	3124.100	–	295
Interface board	1	3124.200	–	295
Condensate hose	1	3301.612	3301.612	303
Threaded adaptor for quick-release fastener with G3/8" internal thread	2	3201.900	3201.900	304
Threaded adaptor for quick-release fastener with G3/8" external thread	2	3201.910	3201.910	304
Flow regulator valve	1		see page 304	

<sup>1)</sup> IP 65 available on request.

Special voltages available on request. We reserve the right to make technical modifications.

## Wall-mounted, useful cooling output 7000 W

Model No. SK	3216.480 <sup>1)</sup>	Page
Temperature control	Thermostat-controlled magnetic valve	
<b>Useful cooling output</b>	<b>L 35 W 10, 500 l/h</b> <b>L 35 W 20, 500 l/h</b>	<b>7000 W</b> <b>4500 W</b>
Rated operating voltage V, Hz	400, 3~, 50/60	460, 3~, 60
Dimensions mm	W x H x D 450 x 1800 x 300	

Rated current max.	1.4 A/1.6 A	1.2 A
Pre-fuse T	4.0 A, 3-pole	
Power consumption P <sub>el</sub>	450 W/700 W	630 W
Cooling medium	Water (for specifications see Internet; user manual)	
Water inlet temperature	+1°C to +30°C	
Permissible operating pressure p. max.	1 to 10 bar	
Operating temperature and setting range	+1°C to +70°C	
Protection category to IEC 60 529	IP 55 <sup>2)</sup>	
Duty cycle	100%	
Type of connection	Terminal strip	
Weight	79 kg	
Air throughput of the fans (unimpeded air flow)	2400 m <sup>3</sup> /h	

Accessories	Packs of			
Digital temperature display/thermostat	1	3114.200		293
Door-operated switch	1	4127.010		496
Condensate hose	1	3301.612		303
Flow regulator valve	1		see page 304	

<sup>1)</sup> Extended delivery times.

<sup>2)</sup> IP 65 available on request.

Special voltages available on request. We reserve the right to make technical modifications.

# Air/water heat exchangers

## Wall-mounted, useful cooling output 500 W, water-carrying parts V4A (1.4571)

Model No. SK	3363.504 <sup>1)</sup>	3363.104 <sup>1)</sup>	Page
Thermostat (factory setting +35°C)	e-Comfort controller	■	–
	Basic controller	–	■
<b>Useful cooling output</b>	<b>L 35 W 10, 400 l/h</b>	<b>500 W</b>	
Rated operating voltage V, Hz	230, 1~, 50/60		
External transformer	–		
Dimensions mm	W x H x D 280 x 550 x 120		

Rated current max.	0.17 A/0.18 A
Pre-fuse T	4.0 A
Cooling medium	Water (for specifications see Internet; user manual)
Water inlet temperature	+1°C to +30°C
Permissible operating pressure p. max.	1 to 10 bar
Operating temperature and setting range	+1°C to +70°C
Protection category to IEC 60 529	IP 55 <sup>2)</sup>
Duty cycle	100%
Type of connection	Plug-in terminal strip
Water connection	Quick-release fastener system <sup>3)</sup>
Weight	12 kg
Air throughput of the fans (unimpeded air flow)	270/320 m <sup>3</sup> /h

Accessories	Packs of			
Door-operated switch	1	4127.010	4127.010	496
SK BUS system	1	3124.100	–	295
Interface board	1	3124.200	–	295
Condensate hose	1	3301.612	3301.612	303
Flow regulator valve	1		see page 304	

<sup>1)</sup> Extended delivery times.

<sup>2)</sup> IP 65 available on request.

<sup>3)</sup> Threaded adaptor for quick-release fastener available on request.

Special voltages available on request. We reserve the right to make technical modifications.

## Wall-mounted, useful cooling output 750 W, water-carrying parts V4A (1.4571)

Model No. SK	3364.504 <sup>1)</sup>	3364.104 <sup>1)</sup>	Page
Thermostat (factory setting +35°C)	e-Comfort controller	■	–
	Basic controller	–	■
<b>Useful cooling output</b>	<b>L 35 W 10, 400 l/h</b>	<b>750 W</b>	
Rated operating voltage V, Hz	230, 1~, 50/60		
External transformer	–		
Dimensions mm	W x H x D 280 x 550 x 120		

Rated current max.	0.2 A/0.19 A
Pre-fuse T	4.0 A
Cooling medium	Water (for specifications see Internet; user manual)
Water inlet temperature	+1°C to +30°C
Permissible operating pressure p. max.	1 to 10 bar
Operating temperature and setting range	+1°C to +70°C
Protection category to IEC 60 529	IP 55 <sup>2)</sup>
Duty cycle	100%
Type of connection	Plug-in terminal strip
Water connection	Quick-release fastener system <sup>3)</sup>
Weight	15 kg
Air throughput of the fans (unimpeded air flow)	270/320 m <sup>3</sup> /h

Accessories	Packs of			
Door-operated switch	1	4127.010	4127.010	496
SK BUS system	1	3124.100	–	295
Interface board	1	3124.200	–	295
Condensate hose	1	3301.612	3301.612	303
Flow regulator valve	1		see page 304	

<sup>1)</sup> Extended delivery times.

<sup>2)</sup> IP 65 available on request.

<sup>3)</sup> Threaded adaptor for quick-release fastener available on request.

Special voltages available on request. We reserve the right to make technical modifications.

# Air/water heat exchangers

## Wall-mounted, useful cooling output 1750 W, water-carrying parts V4A (1.4571)

Model No. SK	3373.504 <sup>1)</sup>	3373.104 <sup>1)</sup>	Page
Thermostat (factory setting +35°C)	e-Comfort controller ■	–	
	Basic controller –	■	
<b>Useful cooling output</b>	<b>L 35 W 10, 400 l/h</b>	<b>1750 W</b>	
Rated operating voltage V, Hz	230, 1~, 50/60		
Dimensions mm	W x H x D 400 x 950 x 140		

Rated current max.	0.38 A/0.43 A
Pre-fuse T	4.0 A
Cooling medium	Water (for specifications see Internet; user manual)
Water inlet temperature	+1°C to +30°C
Permissible operating pressure p. max.	1 to 10 bar
Operating temperature and setting range	+1°C to +70°C
Protection category to IEC 60 529	IP 55 <sup>2)</sup>
Duty cycle	100%
Type of connection	Plug-in terminal strip
Water connection	Quick-release fastener system <sup>3)</sup>
Weight	20 kg
Air throughput of the fans (unimpeded air flow)	600/625 m <sup>3</sup> /h

Accessories	Packs of			
Door-operated switch	1	4127.010	4127.010	496
SK BUS system	1	3124.100	–	295
Interface board	1	3124.200	–	295
Condensate hose	1	3301.612	3301.612	303
Flow regulator valve	1		see page 304	

<sup>1)</sup> Extended delivery times.

<sup>2)</sup> IP 65 available on request.

<sup>3)</sup> Threaded adaptor for quick-release fastener available on request.

Special voltages available on request. We reserve the right to make technical modifications.

## Wall-mounted, useful cooling output 2500 W, water-carrying parts V4A (1.4571)

Model No. SK	3374.504 <sup>1)</sup>	3374.104 <sup>1)</sup>	Page
Thermostat (factory setting +35°C)	e-Comfort controller ■	–	
	Basic controller –	■	
<b>Useful cooling output</b>	<b>L 35 W 10, 400 l/h</b>	<b>2500 W</b>	
Rated operating voltage V, Hz	230, 1~, 50/60		
Dimensions mm	W x H x D 400 x 950 x 140		

Rated current max.	0.57 A/0.78 A
Pre-fuse T	4.0 A
Cooling medium	Water (for specifications see Internet; user manual)
Water inlet temperature	+1°C to +30°C
Permissible operating pressure p. max.	1 to 10 bar
Operating temperature and setting range	+1°C to +70°C
Protection category to IEC 60 529	IP 55 <sup>2)</sup>
Duty cycle	100%
Type of connection	Plug-in terminal strip
Water connection	Quick-release fastener system <sup>3)</sup>
Weight	20 kg
Air throughput of the fans (unimpeded air flow)	700/730 m <sup>3</sup> /h

Accessories	Packs of			
Door-operated switch	1	4127.010	4127.010	496
SK BUS system	1	3124.100	–	295
Interface board	1	3124.200	–	295
Condensate hose	1	3301.612	3301.612	303
Flow regulator valve	1		see page 304	

<sup>1)</sup> Extended delivery times.

<sup>2)</sup> IP 65 available on request.

<sup>3)</sup> Threaded adaptor for quick-release fastener available on request.

Special voltages available on request. We reserve the right to make technical modifications.

# Air/water heat exchangers

## Wall-mounted, useful cooling output 4000 W, water-carrying parts V4A (1.4571)

Model No. SK	3375.504 <sup>1)</sup>		3375.104 <sup>1)</sup>	Page
Thermostat (factory setting +35°C)	e-Comfort controller	■	–	
	Basic controller	–	■	
<b>Useful cooling output</b>	<b>L 35 W 10, 400 l/h</b>	<b>4000 W</b>		
Rated operating voltage V, Hz	230, 1~, 50/60			
Dimensions mm	W x H x D 450 x 1400 x 220			
Rated current max.	1.0 A/1.35 A			
Pre-fuse T	4.0 A			
Cooling medium	Water (for specifications see Internet; user manual)			
Water inlet temperature	+1°C to +30°C			
Permissible operating pressure p. max.	1 to 10 bar			
Operating temperature and setting range	+1°C to +70°C			
Protection category to IEC 60 529	IP 55 <sup>2)</sup>			
Duty cycle	100%			
Type of connection	Plug-in terminal strip			
Water connection	Quick-release fastener system <sup>3)</sup>			
Weight	56 kg			
Air throughput of the fans (unimpeded air flow)	2365/2750 m <sup>3</sup> /h			
<b>Accessories</b>	Packs of			
Door-operated switch	1	4127.010	4127.010	496
SK BUS system	1	3124.100	–	295
Interface board	1	3124.200	–	295
Condensate hose	1	3301.612	3301.612	303
Flow regulator valve	1		see page 304	

<sup>1)</sup> Extended delivery times.

<sup>2)</sup> IP 65 available on request.

<sup>3)</sup> Threaded adaptor for quick-release fastener available on request.

Special voltages available on request. We reserve the right to make technical modifications.



## Rittal Sweden

RITTAL Scandinavian ab  
Rittalgatan 1 · SE-262 73 Ängelholm  
Phone: +46 (431) 44 26 00  
Fax: +46 (431) 44 26 44  
E-mail: info@rittal.se · www.rittal.se

# Cold Plate



Recooling systems page 264 Accessories for climate control page 291

## Liquid-cooled partial mounting plate with drilling surface and T channel

Whole surface can be used by the customer for own tapped holes (blind holes) to a maximum drilling depth of 12 mm. Alternatively, drive units may be secured to the T channel depending on the version.

### Design:

- Press-fitted copper or stainless steel tubes, dependent on the application, in closed recooling systems or existing (open) water infrastructure.
- Cooling water connection: G<sup>1</sup>/<sub>4</sub>" anti-twist

### Supply includes:

Mounting accessories for system integration into TS 8.



### Accessories:

- Quick-action vent valve, see page 263.
- Accessories for fluid distributor connection, see page 263.
- TS punched section with mounting flange 17 x 73 mm for the outer mounting level, see page 459.
- Recooling systems for closed cooling circuits, see from page 264.
- System attachment SK 8616.700, see page 263.

Further technical information is available at [www.rittal.com](http://www.rittal.com)

### Detailed drawing:

Available on the Internet.

## Cold Plate incl. T channel for frequency converters

Model No. SK		8616.602	8616.622	8616.802	8616.822
For installation in	Enclosure width mm	600	600	800	800
	Enclosure depth (side) mm	600	600	800	800
Dimensions mm	W	499	499	699	699
	H	399	399	399	399
	D	20	20	20	20
<b>Output<sup>1)</sup></b>		<b>2500 W</b>	<b>2500 W</b>	<b>3000 W</b>	<b>3000 W</b>
Material		CU	VA	CU	VA
Packs of		1	1	1	1

<sup>1)</sup> At 25°C medium inlet temperature, Cold Plate surface temperature ≈ 50°C, medium flowrate  $\dot{Q} = 200$  l/h, surface roughness: 1.2 µm. Special sizes available on request.



## Rittal Spain

RITTAL Disprel S.A.  
 Mas Baiona, 40  
 Polígono Industrial Can Roqueta  
 08202 Sabadell (Barcelona)  
 Phone: +34 937 001 300  
 Fax: +34 937 001 301  
 E-mail: [info@rittal.es](mailto:info@rittal.es) · [www.rittal.es](http://www.rittal.es)

# Cold Plate

## Accessories

### Fluid distribution manifold

For the connection of up to 4 Cold Plate units.

**Supply includes:**

- 2 fluid distribution manifold blocks (inlet and return)
- Screw plugs G1/4", G3/8"
- Connector sleeves G1/2"
- Seals

Packs of	Model No. SK
1 set	<b>8616.750</b>



**Accessories:**

Flexible hose, see page 263.



**Also required:**

Quick-action vent valve, see page 263.



### Flexible hose

For connection of the Cold Plate to a fluid distribution manifold or direct fluid connection.

**Supply includes:**

- 2 flexible hoses G1/4"
- Seals

Packs of	Length mm	Material	Model No. SK
1 set	500	CU	<b>8616.772</b>
1 set	1000	CU	<b>8616.773</b>
1 set	500	VA	<b>8616.760<sup>1)</sup></b>
1 set	1000	VA	<b>8616.761<sup>1)</sup></b>

<sup>1)</sup> Extended delivery times.



### Quick-action vent valve

To vent the complete Cold Plate system.  
Easily mounted on the fluid distribution manifold.

**Supply includes:**

- Quick-action vent valve G3/8"
- Seal

Packs of	Model No. SK
1	<b>8616.762</b>



### System attachment

**for frequency converters**

For mounting frequency converters on the Cold Plate.

**Supply includes:**

- Wire clamp system
- T-slot blocks

For the attachment of frequency converters	Packs of	Model No. SK
with all-round clamping surface	1	<b>8616.700</b>
with side clamping surfaces	1	<b>8616.710</b>
with clamping surfaces top and bottom	1	<b>8616.720</b>



# Chillers for water



**Air/water heat exchangers** From page 252 **Overflow valve** Page 304 **Cooling medium** Page 305

## Technical design:

- Compact, modular layout of the refrigeration components
- With RiNano coating
- Pump to convey the medium
- Precise temperature control, based on microprocessor technology
- Collective fault signal with floating contact

## Colour:

RAL 7035

## Protection category:

IP 44 (electrics)

## Supply includes:

- Recooling system wired ready for connection
- Multi-lingual documentation
- Functional diagram and wiring plans

## Approvals:

Available on the Internet.

## Layout diagram:

Available on the Internet.

## Characteristic curves of pump:

Available on the Internet.

## Other options:

Available on the Internet.

## TopTherm, cooling output 1/1.5 kW

Model No. SK	3318.600	3318.610	3319.600	3319.610	Page
Rated operating voltage V, Hz	230, 50/60				
Dimensions mm	W 600	H 400	D 430		
<b>Cooling output at</b> <b>T<sub>w</sub> = 10°C/T<sub>u</sub> = 32°C</b> <b>T<sub>w</sub> = 18°C/T<sub>u</sub> = 32°C</b>	<b>0.8 kW/0.9 kW</b> <b>1.0 kW/1.1 kW</b>		<b>1.2 kW/1.3 kW</b> <b>1.5 kW/1.7 kW</b>		
Power consumption	0.63 kW/0.78 kW		0.85 kW/1.05 kW		
Rated current max.	4.2 A/4.1 A		5.4 A/5.3 A		
Pre-fuse T	10 A				
Refrigerant	R134a				
Number of cooling circuits	1				
Temperature range	Environment	+15°C to +43°C			
	Liquid media	+10°C to +30°C			
Pump capacity	See characteristic curve of pump				
Design	Pressure-sealed	Open	Pressure-sealed	Open	
Tank	–	Made from PP plastic	–	Made from PP plastic	
Tank capacity	–	2.5 l	–	2.5 l	
Water connections	1/2" internal thread				
Weight	48 kg		51 kg		
Air throughput of fans	900 m <sup>3</sup> /h				
Temperature control	Microcontroller control (factory setting +20°C)				
<b>Accessories</b>	Packs of				
Metal filters	1	3286.510	3286.510	3286.510	3286.510
					300

Customised solutions and technical modifications available on request.  
We reserve the right to make technical modifications.



# Chillers for water

## TopTherm, cooling output 3/4.5/6 kW

Model No. SK	3320.600	3334.600	3334.660 <sup>2)</sup>	Page
Rated operating voltage V, Hz	400, 3~, 50/60/460, 3~, 60 <sup>1)</sup>			
Dimensions mm	W H D	602 676 645	602 1050 645	
<b>Cooling output at</b> $T_w = 10^\circ\text{C}/T_u = 32^\circ\text{C}$ $T_w = 18^\circ\text{C}/T_u = 32^\circ\text{C}$		<b>2.7 kW/3.0 kW</b> <b>3.0 kW/3.4 kW</b>	<b>3.9 kW/4.7 kW</b> <b>4.5 kW/5.4 kW</b>	<b>4.8 kW/5.2 kW/5.2 kW</b> <b>6.0 kW/6.6 kW/6.6 kW</b>
Power consumption	1.72 kW/1.95 kW		2.00 kW/2.51 kW	4.3 kW/5.1 kW/5.1 kW
Rated current max.	3.8 A/4.6 A/3.9 A		4.9 A/5.9 A/5.0 A	8 A/9.7 A/8 A
Pre-fuse T	10 A			16 A
Refrigerant	R134a			
Number of cooling circuits	1			
Temperature range	Environment	+15°C to +43°C		
	Liquid media	+10°C to +30°C		
Pump capacity	See characteristic curve of pump			
Tank	Made from PP plastic			
Tank capacity	30 l			
Water connections	1/2" internal thread		3/4" internal thread	
Weight (empty)	88 kg	94 kg	125 kg	
Air throughput of fans	1785 m <sup>3</sup> /h		2200/2500 m <sup>3</sup> /h	
Temperature control	Microcontroller control (factory setting +20°C)			
<b>Accessories</b>				
Metal filters		3286.520	3286.520	3286.510
	Packs of	1	1	2
				300

<sup>1)</sup> Supports multiple voltages without rewiring.

<sup>2)</sup> Integral fill level display.

Special voltages and technical modifications available on request.

We reserve the right to make technical modifications.



## Rittal South Korea

RITTAL Co., Ltd.  
Seoul Head Office  
3rd Floor Asaan Venture Tower B/D  
315-6 Yangjae-Dong  
Seocho-Gu · Seoul 137-896 · Korea  
Phone: +82 (0)2-577-6525  
Fax: +82 (0)2-577-6526  
E-mail: rittal@rittal.co.kr · www.rittal.co.kr

# Chillers for water



**Air/water heat exchangers** From page 252 **Overflow valve** Page 304 **Cooling medium** Page 305

## Technical design:

- Compact, modular configuration of the cooling components with integral water tank
- With RiNano coating
- Pump to convey the medium
- Precise temperature control, based on microprocessor technology
- Open system with tank
- Collective fault signal with floating contact

## Colour:

RAL 7035

## Protection category:

IP 44 (electrics)

## Supply includes:

- Recooling system wired ready for connection
- Multi-lingual documentation
- Functional diagram and wiring plans

## Approvals:

Available on the Internet.

## Layout diagram:

Available on the Internet.

## Characteristic curves of pump:

Available on the Internet.

## Other options:

Available on the Internet.

## TopTherm, for wall mounting, cooling output 1/2.5/4 kW

Model No. SK	3360.100	3360.250	3360.470	Page	
Rated operating voltage V, Hz	400, 3~, 50/60/460, 3~, 60 <sup>1)</sup>				
Dimensions mm	W	400	400	500	
	H	950	1580	1580	
	D	310	290	390	
<b>Cooling output at</b> <b>T<sub>w</sub> = 10°C/T<sub>u</sub> = 32°C</b> <b>T<sub>w</sub> = 18°C/T<sub>u</sub> = 32°C</b>	<b>0.8 kW/0.9 kW</b> <b>1.0 kW/1.1 kW</b>	<b>2.1 kW/2.3 kW</b> <b>2.5 kW/2.8 kW</b>	<b>3.3 kW/3.7 kW</b> <b>4.0 kW/4.5 kW</b>		
Power consumption	0.7 kW/0.76 kW	1.55 kW/2.0 kW	1.85 kW/2.74 kW		
Rated current max.	2.7 A/3.0 A	3.7 A/3.8 A	4.6 A/5.2 A		
Pre-fuse T	10 A				
Refrigerant	R134a				
Number of cooling circuits	1				
Temperature range	Environment	+15°C to +43°C			
	Liquid media	+10°C to +30°C			
Pump capacity	See characteristic curve of pump				
Tank	Plastic				
Tank capacity	5 l	10 l	15 l		
Water connections	Quick-release coupling (counterpart included in accessory bag)		3/4" internal thread		
Weight	47 kg	78 kg	103 kg		
Air throughput of fans	500 m <sup>3</sup> /h	710 m <sup>3</sup> /h	2000 m <sup>3</sup> /h		
Temperature control	Microcontroller control (factory setting +20°C)				
<b>Accessories</b>	Packs of				
Filter mat	1	3286.400	3286.400	3286.400	299
Metal filters	1	3286.410	3286.410	3286.410	300

<sup>1)</sup> Supports multiple voltages without rewiring.  
Special voltages and technical modifications available on request.  
We reserve the right to make technical modifications.



## Climate control accessories Page 291

### Benefits:

- Modular design
- Small footprint
- Convenient servicing
- High reliability thanks to standard water bypass

- One version for two frequencies = international compatibility
- Series product available from stock
- Fast delivery, as pre-assembled modules can simply be combined into a recooling system

### Colour:

RAL 7035

### Protection category:

IP 44

### Supply includes:

Fully wired unit ready for connection with side panels and door.

### Layout diagram:

Available on the Internet.

### Characteristic curves of pump:

Available on the Internet.

### Other options:

Available on the Internet.

## TopTherm, cooling output 8 – 40 kW

Model No. SK	3335.590	3335.600	3335.610	3335.620	3335.630	3335.640	3335.650	3335.660	Page		
Rated operating voltage V, Hz	400, 3~, 50 Hz/460, 3~, 60 Hz										
Dimensions mm	W	805	805		1205		1605	2405			
	H	1600	2000		2000		2000	2000			
	D	805	805		805		805	805			
Cooling output <sup>1)</sup> at T <sub>w</sub> = 10°C/T <sub>u</sub> = 32°C	6.5/7.6 kW	6.5/7.6 kW	10.3/11.3 kW	13.8/15.2 kW	16.6/18.7 kW	21.6/23.8 kW	27.6/30.4 kW	33.5/37.5 kW			
Cooling output <sup>1)</sup> at T <sub>w</sub> = 18°C/T <sub>u</sub> = 32°C	8/8.6 kW	8/8.6 kW	12/13.1 kW	16/17.6 kW	20/21.8 kW	25/27.6 kW	32/35.2 kW	40/44 kW			
Power consumption max. kW	3.4/4.0	3.4/4.0	5.9/6.4	6.7/8.0	8.0/9.9	10.5/12.9	13.5/15.9	16.0/19.8			
Rated current max. A	6.4/6.0	6.4/6.0	8.2/9.5	11.1/11.3	15.9/13.9	20.3/20.7	22.2/22.6	31.7/31.5			
Refrigerant	R410A										
Number of cooling circuits	1						2				
Temperature range – environment	+10°C to +43°C										
Temperature range – water	+7°C to +25°C										
Pump capacity at 2.5 bar (l/min.) 50/60 Hz	35/70		30/85		50/140		60/40 (at 60 Hz 3.7 bar)				
Tank capacity l	80				170						
Water connections	1"						1 1/4"				
Weight (empty) kg	245	250	270	325	425	425	580	940			
Temperature control	Microcontroller control (factory setting +18°C, differential value control also possible)										
<b>Accessories</b>	Packs of										
Metal filters	1	3286.550	3286.550	3286.530	3286.530	3286.540	3286.540	3286.530 <sup>2)</sup>	3286.540 <sup>2)</sup>	300	
Levelling feet	4	7493.100	7493.100	7493.100	7493.100	7493.100	7493.100	7493.100	7493.100	371	
Levelling feet with vibration dampening	4	7493.230	7493.230	7493.230	7493.230	7493.230	7493.230	7493.230	7493.230	373	
Base/plinth components front and rear	100 mm	8601.805	8601.805	8601.805	8601.805	8601.200	8601.200	8601.805 <sup>2)</sup>	8601.200 <sup>2)</sup>	361	
	200 mm	8602.805	8602.805	8602.805	8602.805	8602.200	8602.200	8602.805 <sup>2)</sup>	8602.200 <sup>2)</sup>	361	
Base/plinth trim panels, side	100 mm	8601.085	8601.085	8601.085	8601.085	8601.085	8601.085	8601.085	8601.085	362	
	200 mm	8602.085	8602.085	8602.085	8602.085	8602.085	8602.085	8602.085	8602.085	362	
Cooling medium	Canister	10 l	3301.960	3301.960	3301.960	3301.960	3301.960	3301.960	3301.960	3301.960	305
		25 l	3301.965	3301.965	3301.965	3301.965	3301.965	3301.965	3301.965	3301.965	305
		200 l	3301.967	3301.967	3301.967	3301.967	3301.967	3301.967	3301.967	3301.967	305

<sup>1)</sup> Without pump heat losses. <sup>2)</sup> 2 packs. We reserve the right to make technical modifications.

# Chillers for water



**Air/water heat exchangers** from page 252 **Climate control accessories** Page 291 **Cooling medium** Page 305

## Technical design:

- Robust industrial standard
- Variable air routing is possible via the l/h or r/h side panel
- Floating contact for collective fault signal

## Colour:

RAL 7035

## Protection category:

IP 44 (electrics)

## Supply includes:

- Recooling system wired ready for connection
- Multi-lingual documentation
- Functional diagram and wiring plans



## Accessories:

- Metal filter mats
- Castors
- Bypass valve on request

## Approvals:

Available on the Internet.

## Layout diagram:

Available on the Internet.

## Characteristic curves of pump:

Available on the Internet.

## Other options:

Available on the Internet.

## In floor-standing enclosure, cooling output 2.1 to 7.7 kW

Model No. SK	3336.100	3336.200	3336.300	3336.500	3336.600	3336.650
Rated operating voltage V, Hz	400, 3~, 50					
Dimensions mm	W	470	485	595		
	H	725	965	1180		
	D	540	650	800		
Cooling output at $T_w = 10^\circ\text{C}/T_u = 32^\circ\text{C}$ $T_w = 18^\circ\text{C}/T_u = 32^\circ\text{C}$	1.7 kW	2.1 kW	2.3 kW	3.6 kW	4.8 kW	5.2 kW
	2.1 kW	2.6 kW	3.4 kW	5.0 kW	6.2 kW	7.7 kW
Power consumption	1.5 kW	1.7 kW	2.3 kW	2.9 kW	3.7 kW	3.9 kW
Rated current max.	3.4 A	3.0 A	4.2 A	5.5 A	6.2 A	7.3 A
Refrigerant	R134a					
Number of cooling circuits	1					
Temperature range	Environment	+15°C to +43°C				
	Liquid media	+10°C to +25°C				
Pump capacity	See characteristic curve of pump					
Tank	Made from stainless steel 1.4301 (AISI 304)					
Tank capacity	17 l	33 l		57 l		
Water connections	$\frac{3}{4}$ " internal thread			1" internal thread		
Weight	75 kg	97 kg	99 kg	141 kg	143 kg	147 kg
Air throughput of fans	700 m <sup>3</sup> /h	1250 m <sup>3</sup> /h	1785 m <sup>3</sup> /h	3140 m <sup>3</sup> /h		
Temperature control	Electronic control with digital display (factory setting +18°C)					

Extended delivery times.

Special voltages, other frequencies, and technical modifications available on request.

We reserve the right to make technical modifications.

## In floor-standing enclosure, cooling output 10 to 25 kW

Model No. SK	3336.700	3336.710	3336.720	3336.730	3336.740	3336.750
Rated operating voltage V, Hz	400, 3~, 50/460, 3~, 60					
Dimensions mm	W	615			715	
	H	1178			1178	
	D	1160			1360	
<b>Cooling output at</b> $T_w = 10^\circ\text{C}/T_u = 32^\circ\text{C}$ $T_w = 18^\circ\text{C}/T_u = 32^\circ\text{C}$	<b>8.3/10.4 kW</b> <b>10.0/12.6 kW</b>	<b>11.9/15.5 kW</b> <b>14.4/18.7 kW</b>	<b>13.5/16.6 kW</b> <b>16.3/20.1 kW</b>	<b>15.0/18.1 kW</b> <b>18.5/22.4 kW</b>	<b>17.0/20.7 kW</b> <b>20.9/25.4 kW</b>	<b>20.6/26.4 kW</b> <b>25.2/32.3 kW</b>
Power consumption	3.8 kW	4.8 kW	5.3 kW	6.4 kW	7.1 kW	13.1 kW
Rated current max.	10.6 A	13.1 A	14.1 A	16.2 A	18.2 A	23.7 A
Refrigerant	R407C					
Number of cooling circuits	1					
Temperature range	Environment	+15°C to +43°C <sup>1)</sup>				
	Liquid media	+10°C to +25°C				
Pump capacity	See characteristic curve					
Tank	Made from stainless steel 1.4301 (AISI 304)					
Tank capacity	60 l			100 l		
Water connections	1" internal thread					
Weight	215 kg	225 kg	235 kg	240 kg	250 kg	260 kg
Air throughput of fans	6280 m <sup>3</sup> /h			10880 m <sup>3</sup> /h		
Temperature control	Electronic control with digital display (factory setting +18°C)					

<sup>1)</sup> SK 3336.720 and SK 3336.750 +15°C to +40°C at 60 Hz.

Delivery times available on request.

Special voltages and technical modifications available on request.

We reserve the right to make technical modifications.

## In floor-standing enclosure, cooling output 32 to 59 kW

Model No. SK	3339.100	3339.200	3339.250	3339.280
Rated operating voltage V, Hz	400, 3~, 50/460, 3~, 60		400, 3~, 50	
Dimensions mm	W	815		1000
	H	1400		1800
	D	1560		2000
<b>Cooling output at</b> $T_w = 10^\circ\text{C}/T_u = 32^\circ\text{C}$ $T_w = 18^\circ\text{C}/T_u = 32^\circ\text{C}$	<b>26.2/31.4 kW</b> <b>32.0/38.4 kW</b>	<b>29.6/35.5 kW</b> <b>36.2/43.5 kW</b>	<b>40.0 kW</b> <b>46.7 kW</b>	<b>52.0 kW</b> <b>59.0 kW</b>
Power consumption	18.3 kW	18.6 kW	20.6 kW	36.8 kW
Rated current max.	29.2 A	30.7 A	36.8 A	41.1 A
Refrigerant	R407C			
Number of cooling circuits	1			
Temperature range	Environment	+15°C to +43°C		+15°C to +40°C
	Liquid media	+15°C to +25°C		
Pump capacity	See characteristic curve			
Tank	Made from stainless steel 1.4301 (AISI 304)			
Tank capacity	150 l		220 l	
Water connections	1 1/4" internal thread		1 1/2" internal thread	
Weight	260 kg	300 kg	680 kg	740 kg
Air throughput of fans	16000 m <sup>3</sup> /h		32000 m <sup>3</sup> /h	
Temperature control	Electronic control with digital display (factory setting +18°C)			

Extended delivery times.

Special voltages and technical modifications available on request.

We reserve the right to make technical modifications.



# IT cooling

## Roof-mounted cooling units

TopTherm for office and IT applications ..... 1100/3000 W .....246

## Chillers for IT cooling

Chillers for IT cooling..... 15 – 123 kW .....272

Chillers for IT cooling..... 155 – 481 kW .....273

## CRAC system

CRAC system CW ..... 27.8 – 137.4 kW .....274

CRAC system DX ..... 19.2 – 56.2 kW .....276

## Aisle containment

Aisle containment .....278

## Liquid Cooling Package

TopTherm LCP Rack CW and DX ..... up to 60 kW .....279

TopTherm LCP Inline CW and DX ..... up to 60 kW .....280

TopTherm LCP T3+ CW ..... up to 25 kW .....281

TopTherm LCP Passive CW ..... 20 kW .....282

Accessories .....283



# Chillers for IT cooling



Climate control accessories Page 291

## Application:

Especially for cooling IT applications, such as LCP or air/water heat exchangers. Safety-relevant features such as redundant speed-controlled pumps, compressors or buffer stores are the distinguishing features of these atmospherically sealed systems.

## Technical design:

- Compact design with control components in the front and air intake via both side panels, air outlet upwards.
- Pressure-sealed system
- Digital thermostat for temperature control with setpoint and actual value display
- Monitoring interface with Rittal CMC II supported.
- Flow monitor

## Protection category:

IP 54

## Supply includes:

- Chiller wired ready for connection
- Multi-lingual documentation
- Functional diagram and wiring plans

## Options:

- Free cooling may be integrated from 67 kW. Please follow the instructions!
- Buffer store for separate siting
- Emergency cooling with mains water infeed
- Integral bypass
- Special voltages

## Note:

Technical deviations in terms of cooling output, dimensions or weight are possible for unit types with free cooling.

## Layout diagram:

Available on the Internet.

## Cooling output 15 to 124 kW

Model No. SK	3232.700	3232.710	3232.720	3232.730	3232.740	3232.750	3232.760	3232.770	3232.780	3232.790
Rated operating voltage V, Hz	400, 3~, 50									
Dimensions mm	W	810	810	810	1000	1100	1100	1100	1100	1100
	H	1542	1542	1542	1780	1606	1606	1606	1606	1875
	D	1560	1560	1560	2000	2450	2950	2950	2950	2950
<b>Cooling output<sup>1)</sup></b>	<b>15 kW</b>	<b>24 kW</b>	<b>36 kW</b>	<b>48 kW</b>	<b>67 kW</b>	<b>77 kW</b>	<b>88 kW</b>	<b>99 kW</b>	<b>117 kW</b>	<b>124 kW</b>
Power consumption	6.9 kW	9.7 kW	14.6 kW	21 kW	21 kW	24 kW	26 kW	29 kW	36 kW	41 kW
Rated current max.	23.0 A	25.0 A	37.0 A	46.5 A	52.2 A	59.2 A	64.2 A	69.2 A	84.1 A	89.1 A
Refrigerant	R407C				R410A					
P <sub>max.</sub> cooling circuit	28 bar				45 bar					
Temperature range	Environment	–20°C to +43°C								
	Liquid media	+5°C to +15°C								
Pump capacity	60 l/min.		120 l/min.		240 l/min.			500 l/min.		
Pump pressure	2.5 bar									
Number of cooling circuits	1				2					
Tank with 10 mm condensate insulation	Steel									
Tank capacity	48 l			100 l	300 l			500 l		
Water connections	1"		1 1/4"	2"		2 1/2"				
Operating weight	375 kg	390 kg	480 kg	710 kg	831 kg	896 kg	906 kg	912 kg	1119 kg	1123 kg
Colour	RAL 7035				RAL 9002					
Air throughput of fans	m <sup>3</sup> /h		10880	14000	18000	22000		27000	34100	
Temperature control	Electronic control with digital display (factory setting +15°C)									

<sup>1)</sup> The performance data varies according to the option package chosen, and should be taken from the IT chiller configurator (see Internet). Extended delivery times. We reserve the right to make technical modifications.



# Chillers for IT cooling

## Cooling output 155 to 481 kW

Model No. SK	3232.800	3232.810	3232.820	3232.890	3232.830	3232.840	3232.850	3232.860	3232.870	3232.880	
Rated operating voltage V, Hz	400, 3~, 50										
Dimensions mm	W	1100	1100	1100	1500	2200	2200	2200	2200	2200	
	H	1875	1875	1875	1975	2450	2450	2450	2450	2450	
	D	2950	2950	3950	4350	3400	3400	3400	4250	4250	
<b>Cooling output<sup>1)</sup></b>	<b>155 kW</b>	<b>172 kW</b>	<b>196 kW</b>	<b>235 kW</b>	<b>262 kW</b>	<b>291 kW</b>	<b>326 kW</b>	<b>387 kW</b>	<b>430 kW</b>	<b>481 kW</b>	
Power consumption	47 kW	52 kW	60 kW	70 kW	80 kW	93 kW	106 kW	121 kW	141 kW	159 kW	
Rated current max.	108 A	120 A	127 A	149 A	181 A	203 A	225 A	293 A	307 A	336 A	
Refrigerant	R410A										
P <sub>max.</sub> cooling circuit	45 bar										
Temperature range	Environment	-20°C to +43°C									
	Liquid media	+5°C to +15°C									
Pump capacity	500 l/min.			500 l/min.	810 l/min.			1200 l/min.			
Pump pressure	2.5 bar										
Number of cooling circuits	2										
Tank with 10 mm condensate insulation	Steel										
Tank capacity	500 l			700 l				1000 l			
Water connections	2 1/2"			3"				4"			
Operating weight	1308 kg	1321 kg	1489 kg	1933 kg	2546 kg	2693 kg	2843 kg	3148 kg	3354 kg	3576 kg	
Colour	RAL 9002										
Air throughput of fans	m <sup>3</sup> /h		32600	50000	49000	72800	71500	70200	106200	104100	102000
Temperature control	Electronic control with digital display (factory setting +15°C)										

<sup>1)</sup> The performance data varies according to the option package chosen, and should be taken from the IT chiller configurator (see Internet).  
Extended delivery times. We reserve the right to make technical modifications.



## Rittal Austria

RITTAL Schaltschränke Gesellschaft m.b.H.  
Laxenburger Straße 246a · A-1239 Wien  
Phone: +43 (0) 5 99 40-0  
Fax: +43 (0) 5 99 40-99 0  
E-mail: info@rittal.at · www.rittal.at

# CRAC system CW



Chillers for IT cooling Page 272 Liquid Cooling Package Page 279

## Application and mode of operation:

The CRAC system draws warm waste air from the top of your data centre, cools it using water in a closed heat exchanger, and blows the cooled, filtered supply air into the raised floor with overpressure.

The heated cooling water is cooled in an external recooling system outside of the building.

## Benefits:

- Broad output range, suitable for use with a wide range of cooling media.
- The unit supports optimum integration of both hardware and software.
- Optimum energy and space efficiency thanks to intelligent design features, such as the slanted heat exchanger and base-integrated fan.
- Frame based on the popular TS 8 system.

## Equipment:

- User-friendly, high-quality controller with an extensive range of functions and connectivity.
- Space-saving, readily accessible, high-efficiency fan.
- Flow and energy-optimised special heat exchanger with a generous safety factor.

**Colour:**  
RAL 7035

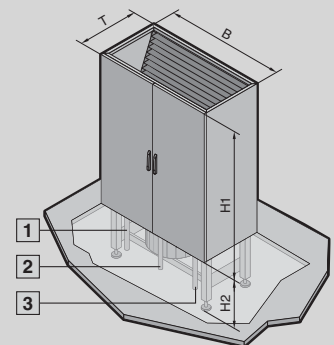

**1** Water inlet, condensate discharge, humidifier inlet

**2** Electrical connection

**3** Water return

## Base unit

Top piece		Model No. SK			
		3301.620	3301.660	3301.830	3301.870
Dimensions mm	W (B)	1100	1100	1800	2600
	H1	1950	1950	1950	1950
	D (T)	650	850	850	850
Connection voltage	V/Ph/Hz	400/3/50	400/3/50	400/3/50	400/3/50

## Fan unit in base

Supporting structure with fan		Model No. SK			
		3300.310	3300.320	3300.330	3300.340
No. of fans	Quantity	1	1	2	3
Height of supporting structure mm <sup>1)</sup>	H2	500	550	550	550
Min. raised floor height mm		350	350	350	350

<sup>1)</sup> Other supporting structure heights available on request.

# CRAC system CW

## Base unit

Model No. SK		3301.620	3301.660	3301.830	3301.870
<b>Rated volumetric flow</b>					
Air volume	m <sup>3</sup> /h	6000	11000	22000	33000
External compression	Pa	20	20	20	20
Support area	m <sup>2</sup>	0.72	0.94	1.53	2.21
Weight	kg	340	385	585	843
<b>Cooling – cold water 7°C/12°C and air inlet 24°C/50% relative humidity</b>					
Cooling output, total	kW	27.8	45.7	90.2	137.4
Cooling output, sensitive	kW	23.4	39.8	79.4	119.5
SHR <sup>1)</sup>		0.84	0.87	0.88	0.87
Volumetric flow of medium	m <sup>3</sup> /h	4.78	7.85	15.49	23.6
Cooler pressure loss	kPa	33.4	39	37.6	37.5
Valve pressure loss	kPa	22.8	24.1	38.4	34.8
Connection		Rp 1	Rp 1 1/4	Rp 1 1/2	Rp 2
<b>Cooling – cold water 10°C/15°C and air inlet 26°C/45% relative humidity</b>					
Cooling output, total	kW	22.9	39.1	77.4	117.2
Cooling output, sensitive	kW	22.9	39.1	77.4	117.2
SHR <sup>1)</sup>		1	1	1	1
Volumetric flow of medium	m <sup>3</sup> /h	3.94	6.72	13.3	20.2
Cooler pressure loss	kPa	23.4	29.1	28.2	27.8
Valve pressure loss	kPa	15.5	17.6	28.3	25.5
Connection		Rp 1	Rp 1 1/4	Rp 1 1/2	Rp 2
<b>Filter in intake</b>					
Design		Cassette filter			
Filter class to DIN EN 779		G4	G4	G4	G4
<b>Noise data</b>					
Sound power level, intake end	dB (A)	69	74	77	79
Sound power level, discharging end	dB (A)	79	82	85	87
Enclosure radiation	dB (A)	55	60	63	65
Sound pressure level in empty space (2 m distance)	dB (A)	57	62	65	67

<sup>1)</sup> SHR = Sensible Heat Ratio. We reserve the right to make technical modifications in line with progress.

## Fan unit

Design		EC motor, directly driven, free-running			
Qty.	Quantity	1	1	2	3
Power consumption, total	kW	0.6	1.4	3.1	4.6
Max. current rating	A	1.5	4.6	9.2	13.8

## Options

<b>Steam humidification</b>					
Design		Electrode steam humidifier			
Max. steam output	kg/h	8	8	15	15
Max. power consumption	kW	6	6	11.3	11.3
Max. current rating	A	8.7	8.7	16.3	16.3
Water inlet connection	Inches	G 1/2	G 1/2	G 1/2	G 1/2
Water discharge connection	mm	40	40	40	40

<b>Electric heater</b>					
Design		Bare-tube heater, permanently controlled			
Max. thermal output	kW	4.5	7.5	15	22.5
Max. current rating	A	6.5	10.8	21.7	32.5

<b>Energy-saving extractor plenum</b>					
For top-mounting on CRAC systems		3300.290	3300.291	3300.292	3300.293

# CRAC system DX



Chillers for IT cooling Page 272 Liquid Cooling Package Page 279

## Application and mode of operation:

The air-cooled DX units with direct evaporation discharge the heat to the external air via an air-cooled condenser installed outside of the building. The climate control enclosure has one, two or three compressors, depending on size, which are combined into **one** cooling circuit. For this reason, connection to the air-cooled condenser is via just **one** refrigerant line.

## Benefits:

- Broad output range, suitable for use with a wide range of cooling media.
- The unit supports optimum integration of both hardware and software.
- Optimum energy and space efficiency thanks to intelligent design features, such as the slanted heat exchanger and base-integrated fan.
- Frame based on the popular TS 8 system.

## Equipment:

- User-friendly, high-quality controller with an extensive range of functions and connectivity.
- Space-saving, readily accessible, high-efficiency fan.
- Flow and energy-optimised special heat exchanger with a generous safety factor.

**Colour:**  
RAL 7035

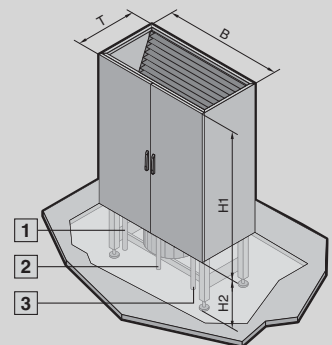

**1** Refrigerant pressure line, condensate discharge, humidifier inlet

**2** Electrical connection

**3** Refrigerant fluid line

## Base unit

Top piece		Model No. SK			
		3300.510	3300.560	3300.710	3300.760
Dimensions mm	W (B)	1100	1100	1400	1800
	H1	1950	1950	1950	1950
	D (T)	850	850	850	850
Connection voltage	V/Ph/Hz	400/3/50	400/3/50	400/3/50	400/3/50

## Fan unit in base

Supporting structure with fan		Model No. SK			
		3300.360	3300.320	3300.370	3300.330
Height of supporting structure mm <sup>1)</sup>	H2	500	550	550	550
Min. raised floor height mm		350	350	350	350

<sup>1)</sup> Other supporting structure heights available on request.

## Condenser unit

		Model No. SK			
		3300.353	3300.354	3300.355	3300.356
No. of fans	Quantity	1	2	2	2
Max. volumetric flow	m <sup>3</sup> /h	8500	12400	18000	18400
Connection voltage	V/Ph/Hz	230/1/50	230/1/50	230/1/50	230/1/50

# CRAC system DX

## Base unit

Model No. SK		3300.510	3300.560	3300.710	3300.760
<b>Rated volumetric flow</b>					
Air volume	m <sup>3</sup> /h	6000	8500	12500	16000
External compression	Pa	20	20	20	20
Support area	m <sup>2</sup>	0.94	0.94	1.19	1.53
Weight	kg	455	505	585	871
<b>Cooling – condensation temperature 45°C and air inlet 24°C/50% relative humidity</b>					
Design		Scroll compressor			
No. of compressors	Quantity	1	2	3	3
Cooling output, total	kW	19.2	31.4	46.4	56.2
Cooling output, sensitive	kW	18.3	28.3	41.5	51.9
SHR <sup>1)</sup>		0.95	0.90	0.89	0.92
Power consumption, total	kW	4.4	7.7	11.5	13.3
Max. operating temperature	A	13.1	25.6	38.4	39.3
<b>Filter in intake</b>					
Design		Cassette filter			
Filter class to DIN EN 779		G4	G4	G4	G4
<b>Noise data</b>					
Sound power level, intake end	dB (A)	69	69	77	72
Sound power level, discharging end	dB (A)	79	76	84	79
Enclosure radiation	dB (A)	54	56	62	59
Sound pressure level in empty space (2 m distance)	dB (A)	57	57	64	59

<sup>1)</sup> SHR = Sensible Heat Ratio. We reserve the right to make technical modifications in line with progress.

## Fan unit

Design		EC motor, directly driven, free-running			
Qty.	Quantity	1	1	1	2
Power consumption, total	kW	0.5	0.8	1.8	1.6
Max. current rating	A	1.8	4.6	4.6	9.2

## Condenser unit

Design		Axial fan condenser			
Condenser output	kW	27	38	49	71
Max. power consumption	kW	0.67	1.28	1.34	1.34
Max. current rating	A	3.3	6	6.0	6.6
Max. noise level in empty space (5 m distance)	dB (A)	56	60	59	59
Dimensions mm	Width (B1 + B2)	1415	1420	2130	2680
Weight	kg	109	132	160	217

Design  
Vertically blowing

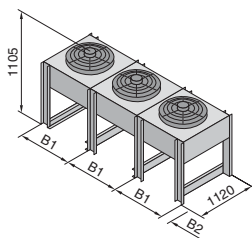

Design  
Horizontally blowing

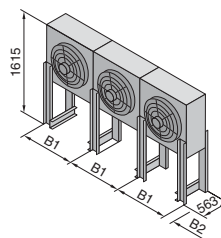

## Options

<b>Steam humidification</b>					
Design		Electrode steam humidifier			
Max. steam output	kg/h	8	8	8	15
Max. power consumption	kW	6	6	6	11.3
Max. current rating	A	8.7	8.7	8.7	16.3
Water inlet connection	Inches	G 1/2	G 1/2	G 1/2	G 1/2
Water discharge connection	mm	40	40	40	40

<b>Electric heater</b>					
Design		Bare-tube heater, permanently controlled			
Max. thermal output	kW	4.5	7.5	7.5	15
Max. current rating	A	6.5	10.8	10.8	21.7

<b>Energy-saving extractor plenum</b>					
For top-mounting on CRAC systems		3300.294	3300.295	3300.296	3300.297

# Aisle containment



TopTherm LCP Passive CW From page 282

## Application and mode of operation:

Aisle containment is a combination of door and roof components which facilitate consistent separation of the hot and cold air in the data centre. Such separation is pivotal to saving energy and increasing the efficiency of the available climate control technology. Depending on the application, aisle containment may be used with CRAC systems or TopTherm LCP Inline CW and DX as hot or cold aisle containment.

## Benefits:

- Increased energy efficiency and performance capability of climate control.
- Superior output density is facilitated, thanks to guaranteed cold air supply.
- Easily installed and retrofitted, as it is fully compatible with the TS 8 enclosure system.
- An inexpensive way to boost the performance of your existing plant, lengthening the investment cycle until a replacement needs to be purchased.

## Equipment:

- Slimline door element with viewing window, sliding door
- Stable roof elements in a composite metal with a high level of light permeability
- Where required, safety glass may also be used

## Note:

Other size variants and individually modified systems available on request.

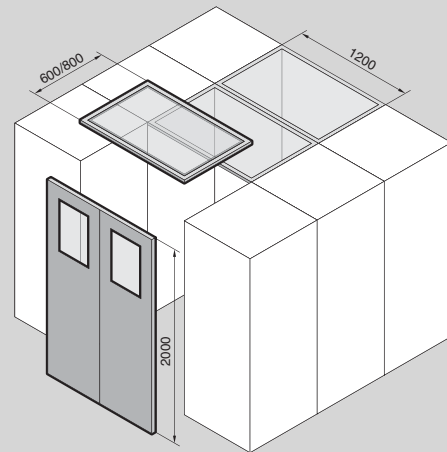

Element	Roof element				Door element
	Start/end		Centre		
<b>Model No. SK</b>	<b>3300.270</b>	<b>3300.280</b>	<b>3300.170</b>	<b>3300.180</b>	<b>3300.160</b>
Width of element (identical to enclosure width) mm	600	800	600	800	–
Width of cold aisle mm	1200	1200	1200	1200	1200
Height of cold aisle mm	–	–	–	–	2000

# Liquid Cooling Package



Accessories for climate control Page 291 Chillers for IT cooling Page 272 Server enclosures Page 92

## Benefits:

- Maximum energy efficiency thanks to EC fan technology and IT-based control
- Minimal pressure loss at the air end, which in turn minimises the power consumption of the fans
- Optimum adaptability thanks to dynamic, continuous control of the cold water volume flow
- By using high water inlet temperatures, the proportion of indirect free cooling is increased, which in turn reduces operating costs
- Thanks to six modular, box-type plug-in fan units, the cooling output can be adapted to actual requirements

- The box-type plug-in fan units are configurable as n+1 redundancy
- Standard 3-phase connection for electrical redundancy
- With redundant temperature sensor integrated at the air end as standard
- The separation of cooling and rack prevents water from penetrating the server enclosure
- Up to 60 kW cooling output on a footprint of just 0.36 m<sup>2</sup>
- The low weight means a minimal load area
- Touchscreen display may be retrofitted

## Monitoring:

Monitoring of all system-relevant parameters such as:

- Server air intake temperature
- Server waste air temperature
- Water inlet/return temperature
- Water flow
- Cooling output
- Fan speed
- Leakage
- Optional sensors
- Direct connection of the unit via SNMP/Ethernet
- Integration into RiZone

## Application and mode of operation:

The LCP draws in the air at the sides at the rear of the server enclosures, cools it using high-performance compact impellers, and blows the cooled air back into the front part of the server enclosure at the sides.

## Colour:

RAL 7035

## Protection category:

IP 40 to IEC 60 529

## TopTherm LCP rack CW and DX

Design	CW	CW	CW	DX	Page
<b>Cooling medium</b>	Water (for specifications see Internet)			Refrigerant R410a	
<b>Model No. SK</b>	<b>3311.130</b>	<b>3311.230</b>	<b>3311.260</b>	<b>3311.110</b>	
Rated operating voltage V, Hz	230, 1~, 50/60 400, 3~, 50/60	230, 1~, 50/60 400, 3~, 50/60	230, 1~, 50/60 400, 3~, 50/60	230, 1~, 50/60 400, 3~, 50/60	
Dimensions mm	W x H x D 300 x 2000 x 1000		300 x 2000 x 1200	300 x 2000 x 1000	
Usable U	42		42	42	
<b>Useful cooling output</b>	<b>Up to 30 kW</b>	<b>Up to 30 kW</b>	<b>Up to 60 kW</b>	<b>Up to 10 kW</b>	
Duty cycle	100%				
Electrical connection	Connection cable				
Temperature control	Linear fan control				
	Two-way control valve			–	
Fans may be exchanged with the system operational	■	■	■	■	
EC fan	■	■	■	■	
<b>Also required</b>	Packs of				
Condenser unit	1	–	–	3311.310	283
<b>Accessories</b>					
Fan module	1	<b>3311.010</b>	<b>3311.010</b>	<b>3311.010</b>	<b>3311.010</b>
Touchscreen display, colour	1	3311.030	3311.030	3311.030	283
Connection hose, top	1	3311.040	3311.040	3311.040	283
Connection hose, bottom	1	3311.050	3311.050	3311.050	283

# Liquid Cooling Package



Accessories for climate control Page 291 Chillers for IT cooling Page 272 Server enclosures Page 92 Aisle containment Page 278

## Benefits:

- Maximum energy efficiency thanks to EC fan technology and IT-based control
- Minimal pressure loss at the air end, which in turn minimises the power consumption of the fans
- Optimum adaptability thanks to dynamic, continuous control of the cold water volume flow
- By using high water inlet temperatures, the proportion of indirect free cooling is increased, which in turn reduces operating costs
- Thanks to six modular, box-type plug-in fan units, the cooling output can be adapted to actual requirements

- The box-type plug-in fan units are configurable as n+1 redundancy
- Standard 3-phase connection for electrical redundancy
- With redundant temperature sensor integrated at the air end as standard
- The separation of cooling and rack prevents water from penetrating the server enclosure
- Up to 60 kW cooling output on a footprint of just 0.36 m<sup>2</sup>
- The low weight means a minimal load area
- Touchscreen display may be retrofitted

## Monitoring:

Monitoring of all system-relevant parameters such as:

- Server air intake temperature
- Server waste air temperature
- Water inlet/return temperature
- Water flow
- Cooling output
- Fan speed
- Leakage
- Optional sensors
- Direct connection of the unit via SNMP/Ethernet
- Integration into RiZone

## Application and mode of operation:

The LCP is designed for siting within a bayed enclosure suite. The hot air is drawn in from the room or hot aisle at the rear of the device and expelled at the front into the cold aisle after cooling. The LCP achieves maximum performance and efficiency in conjunction with Rittal cold aisle containment. With this product, a raised floor is not necessary.

**Colour:**  
RAL 7035

**Protection category:**  
IP 40 to IEC 60 529

## TopTherm LCP Inline CW and DX

Design	CW	CW	DX	Page
<b>Cooling medium</b>	Water (for specifications see Internet)		Refrigerant R410a	
<b>Model No. SK</b>	<b>3311.530</b>	<b>3311.560</b>	<b>3311.210</b>	
Rated operating voltage V, Hz	230, 1~, 50/60 400, 3~, 50/60	230, 1~, 50/60 400, 3~, 50/60	230, 1~, 50/60 400, 3~, 50/60	
Dimensions mm	W x H x D	300 x 2000 x 1200	300 x 2000 x 1200	300 x 2000 x 1200
Usable U	42	42	42	
<b>Useful cooling output</b>	<b>Up to 30 kW</b>	<b>Up to 60 kW</b>	<b>Up to 10 kW</b>	
Duty cycle	100%			
Electrical connection	Connection cable			
Temperature control	Linear fan control			
	Two-way control valve		–	
Fans may be exchanged with the system operational	■	■	■	
EC fan	■	■	■	
<b>Also required</b>	Packs of			
Condenser unit	1	–	3311.310	283
<b>Accessories</b>				
Front cover	1	3311.060	3311.060	3311.060
Fan module	1	<b>3311.020</b>	<b>3311.020</b>	<b>3311.020</b>
Touchscreen display, colour	1	3311.030	3311.030	3311.030
Connection hose, top	1	3311.040	3311.040	3311.040
Connection hose, bottom	1	3311.050	3311.050	3311.050



# Liquid Cooling Package



Accessories for climate control Page 291 Chillers for IT cooling Page 272 Server enclosures Page 92

## Benefits:

- Error-tolerant, efficient cooling of server racks with high thermal loads
- Fully redundant – Two active cooling circuits and two switchable power circuits ensure optimum fail-safeness
- The built-in controllers are capable of adapting all device parameters automatically to preserve the required climate conditions

- A separate decentralised intelligence which automatically recognises emergency situations and responds appropriately with the “auto load balancing” and “auto recovery” functions
- Interfaces which facilitate user-friendly operation and monitoring via the network or BSM systems

## Optional:

- Fully integrated fire detection and extinguisher system
- Automatic server enclosure door opening
- Various sensors

## Colour:

RAL 7035

## Protection category:

IP 40 to IEC 60 529

## Application and mode of operation:

The LCP draws in the air at the sides at the rear of the server enclosures, cools it using high-performance compact impellers, and blows the cooled air back into the front part of the server enclosures at the sides.

## TopTherm LCP T3+ CW

<b>Cooling medium</b>	Water (for specifications see Internet)		Page
<b>Model No. SK</b>	<b>3311.400</b>		
Rated operating voltage V, Hz	230, 1~, 50/60 400, 3~, 50/60		
Dimensions mm	W x H x D	300 x 2000 x 1200	
Usable U	42		
<b>Useful cooling output, redundant</b>	<b>Up to 25 kW</b>		
Duty cycle	100%		
Electrical connection	C19/C20		
Temperature control	Linear fan control Two-way control valve		
Fans may be exchanged with the system operational	■		
EC fan	■		
Auto-load balancing	■		
Auto-recovery	■		
<b>Accessories</b>			
Fan module	1	<b>3311.010</b>	–
Touchscreen display, colour	1	3311.030	283
Connection hose, top	1	3311.040	283
Connection hose, bottom	1	3311.050	283

# Liquid Cooling Package



Accessories for climate control Page 291 Chillers for IT cooling Page 272 Server enclosures Page 92

#### Benefits:

- High cooling output of 20 kW in a minimal space
- Easily exchanged for the standard rear door of the server enclosure
- Retrofitting is not a problem
- A door opening angle of 120° allows rear access to the server enclosure and makes assembly and configuration inside the enclosure easier

- The LCP does not require its own fan, and therefore does not need an integrated control
- Maximum energy efficiency, as there is no electrical power consumption whatsoever

#### Application and mode of operation:

Air/water heat exchanger mechanically integrated into a rear door for server enclosures. The 482.6 mm (19") equipment built into the server enclosure must have suitable airflow capabilities in order to route the heated waste air through the heat exchanger rear door. The waste air is cooled down to room temperature. The heat energy absorbed by the water is transported to the external cold water supply, where it is cooled back down to the required inlet temperature.

#### Colour:

RAL 7035

#### Approvals:

Available on the Internet.

## TopTherm LCP Passive CW

<b>Model No. SK</b>	<b>3311.600</b>
Dimensions mm	W x H x D 600 x 2000 x 170
Usable U	42
<b>Useful cooling output</b>	<b>Up to 20 kW</b>



## Rittal China

RITTAL Electro-Mechanical Technology (Shanghai) Co. Ltd.  
 No. 1658 Minyi Road · Songjiang District  
 Shanghai, 201612  
 Phone: +86 (0) 21 5115 7799  
 Fax: +86 (0) 21 5115 7788  
 E-mail: marketing@rittal.cn · www.rittal.cn

# Liquid Cooling Package

## Accessories

### Touchscreen display, colour

for LCP rack, inline, T3+

The display offers the opportunity of directly monitoring key LCP functions and implementing settings.

Packs of	Model No. SK
1	3311.030



### Front cover

for LCP Inline CW and DX

The optional front cover ensures an even air exhaust and reduces the air outlet speed, thereby preventing draught effects.

Packs of	Model No. SK
1	3311.060



### Condenser unit

The condenser unit is needed to operate the refrigerant-based LCPs, and comprises the external condenser, fan and inverter-controlled compressor.

**Refrigerant:**

R410a

For LCP	Packs of	Model No. SK
SK 3311.110, SK 3311.210	1	3311.310



### Vertical shielding

To block the airflow on the left and right of the 482.6 mm (19") level, for enclosure height 2000 mm.

**Material:**

- Cellular PU foam
- Flame-inhibiting to UL 94 (HF1)
- Length: 1900 mm
- Self-adhesive on one side

For sealing between	For enclosure width mm	Packs of	Model No. SK
Side panel and 482.6 mm (19") level	600	1	3301.380
	800	1	3301.390
LCP and 482.6 mm (19") level	600	1	3301.370
	800	1	3301.320



### Connection hose, bottom and top

Flexible connection hose, may be shortened, including union nuts on both sides for connecting the LCP to existing pipework.

For LCP	Thread	Water connection from	Packs of	Model No. SK
SK 3311.130, SK 3311.230, SK 3311.260, SK 3311.530, SK 3311.560, SK 3311.400, SK 3311.110, SK 3311.210	1 1/4"	Bottom	2	3311.050
		Top	2	3311.040



### Add-on cover

For height compensation with 2200 mm high racks in conjunction with the LCP (H = 2000 mm).

**Material:**

Sheet steel

**Surface finish:**

Spray-finished

**Colour:**

RAL 7035

For LCP	Packs of	Model No. SK
SK 3311.130, ....110	1	3301.221
SK 3311.230, ....260, SK 3311.530, ....560, SK 3311.400, ....210	1	3301.421

Extended delivery times.





# CS Outdoor climate control

---

## Air/air heat exchangers

For CS Toptec .....	.85/105 W/K .....	286
For CS modular enclosures .....	.30 W/K .....	287

## Cooling units

For CS Toptec .....	1000/1600 W .....	286
For CS modular enclosures .....	900/1500 W .....	287



# CS Outdoor climate control



CS Toptec Page 185 Enclosure heaters Page 289

With sealing frame for universal mounting on the CS Toptec in 3 positions: Internal, partial internal and external.

**Surface finish:**  
Powder-coated, pure polyester

**Colour:**  
RAL 7035

**Protection category:**  
IP 55 to IEC 60 529 (internal circuit to external circuit)

**Material:**  
Enclosure: Aluminium

## Air/air heat exchangers and cooling units for CS Toptec

Model No. CS	Air/air heat exchangers		Cooling units		
	9776.102	9776.152	9776.500	9776.550	
Installation	Universal				
Rated operating voltage	DC	48 V		–	
	AC	–		230 V, 50/60 Hz	
Enclosure dimensions mm (including sealing frame and designer cover)	W	500 (550)	500 (550)	500 (550)	500 (550)
	H	1000 (1050)	1000 (1050)	1000 (1050)	1000 (1050)
	D	150 (175)	200 (225)	150 (175)	260 (285)
Minimum enclosure dimensions (mm)	W x H	800 x 1200			
<b>Specific thermal output</b>		<b>85 W/K</b>	<b>105 W/K</b>	–	–
<b>Useful cooling output <math>\dot{Q}_K</math> to DIN 3168</b>	<b>L 35 L 35 L 35 L 50</b>	–	–	<b>1000 W/1150 W 650 W/700 W</b>	<b>1600 W/1750 W 1200 W/1250 W</b>
Heater		–	–	400 W	
Rated current max.	DC	4.2 A	4.5 A	–	–
	AC	–		5.0 A/5.0 A	6.0 A/6.8 A
Start-up current max.		–		24.0 A/22.0 A	34.0 A/32.0 A
Power consumption $P_{ei}$ to DIN 3168	L 35 L 35	–		640 W/760 W	960 W/1170 W
	L 35 L 50	–		780 W/920 W	1125 W/1310 W
Coolant		–		R134a	
Permissible operating pressure p. max.		–		28 bar	28 bar
Temperature range		–33°C to +65°C		–33°C to +55°C	
Air throughput of fans – unimpeded air flow	Internal/external circuit fan	570 m <sup>3</sup> /h	1200 m <sup>3</sup> /h	600/625 m <sup>3</sup> /h	880/950 m <sup>3</sup> /h
				600/625 m <sup>3</sup> /h	1000/1090 m <sup>3</sup> /h
Temperature control		Comfort controller <sup>1)</sup>	Comfort controller <sup>1)</sup>	Comfort controller	Comfort controller
Type of connection		Plug-in terminal strip			
Weight		22 kg	30 kg	35 kg	45 kg

Extended delivery times. Products are manufactured to order. The units are assembled and supplied connected to the Toptec enclosure.

<sup>1)</sup> Setpoint settings may be altered via software.

# CS Outdoor climate control



CS modular enclosures Page 186 Enclosure heaters Page 289

### For roof mounting

With Comfort controller as standard<sup>1)</sup> and 400 W heater or control via thermostat.  
Heat exchanger CS 9764.040 without Comfort controller.

### Mounting frame:

Required for CS 9762.212.

### For wall mounting

With Comfort controller<sup>1)</sup> and 400 W heater as standard.

### For partial installation

With Comfort controller<sup>1)</sup> and 800 W heater as standard.

### Installation options:

- in the door or rear panel
- in the side panel

### Surface finish:

Powder-coated, pure polyester

### Colour:

RAL 7035

### Protection category:

IP 55 to IEC 60 529 (internal circuit to external circuit)

<sup>1)</sup> Units with Comfort controller. The Comfort controller is installed on the inside of the cooling units, and is not accessible from the outside.

## Air/air heat exchangers and cooling units for CS modular enclosures

Model No. CS	Air/air heat exchangers		Cooling units		
	9764.040	9762.212	9761.212	9768.152	
Installation	Roof-mounted	Roof-mounted	Wall-mounted	Partial internal mounting	
Rated operating voltage	DC	48 V	–		
	AC	–	230 V, 50/60 Hz		
Unit dimensions (mm)	W x H x D	470 x 158 x 380	535 x 390 x 400	515 x 1170 x 152	400 x 1050 x 310
Minimum enclosure dimensions (mm)	W x D	600 x 500	600 x 500	W x H 600 x 1200	W/D x H 600 x 1200
Specific thermal output		30 W/K	–	–	–
Useful cooling output $\dot{Q}_k$ to DIN 3168	L 35 L 35	–	900 W/1020 W	900 W/1050 W	1500 W/1600 W
	L 35 L 50	–	720 W/780 W	750 W/820 W	1250 W/1250 W
Heater		–	400 W	400 W	800 W
Rated current max.	DC	1.3 A	–	–	–
	AC	–	3.1 A/4 A	3.2 A/4.2 A	5.8 A/6.7 A
Start-up current max.		–	10.6 A	10.8 A	19.0 A
Power consumption $P_{ei}$ to DIN 3168	L 35 L 35	–	460 W/570 W	605 W/790 W	940 W/1145 W
	L 35 L 50	–	520 W/655 W	690 W/880 W	1045 W/1270 W
Temperature control		Without <sup>2)</sup>	Comfort controller	Comfort controller	Comfort controller
Coolant	R134a	–	550 g	600 g	650 g
Permissible operating pressure p. max.		–	27 bar	24 bar	28 bar
Temperature range		–33°C to +65°C	–33°C to +55°C		
Air throughput of fans – unimpeded air flow	Internal/ external circuit fan	345 m <sup>3</sup> /h	570 m <sup>3</sup> /h 570 m <sup>3</sup> /h	880 m <sup>3</sup> /h 880 m <sup>3</sup> /h	850 m <sup>3</sup> /h 680 m <sup>3</sup> /h
	Type of connection	Plug panel	Plug-in terminal strip		
Weight		7 kg	29 kg	45 kg	40 kg
Material (enclosure)	Aluminium/sheet steel	■/–	■/–	–/■	■/–
<b>Accessories</b>					
Mounting frame		–	9765.051	–	–
Enclosure internal thermostat		3110.000	–	–	–

Extended delivery times. The partially internally mounted CS 9768.152 may be inserted directly. Cooling units are manufactured to order. The units are assembled and supplied connected to the modular enclosure. Adaptations to other enclosure platforms are available on request.

<sup>2)</sup> Customers may fit their own thermostat (SK 3110.000).







Climate control accessories Page 291 Software & services Page 333

**Supply includes:**

- PTC heater
- Quick-connection terminal
- Assembly parts

**Note:**

- For precise temperature control inside the enclosure, we recommend the enclosure internal thermostat SK 3110.000 or the digital thermostat SK 3114.200 with display (see accessories).

- In order to prevent condensation on assemblies, hygrostat SK 3118.000 (see accessories) is recommended to regulate heating.
- In larger enclosures, even heat distribution is best achieved by installing several low-output heaters.
- The installation of heaters is generally advisable, in order to prevent condensation.

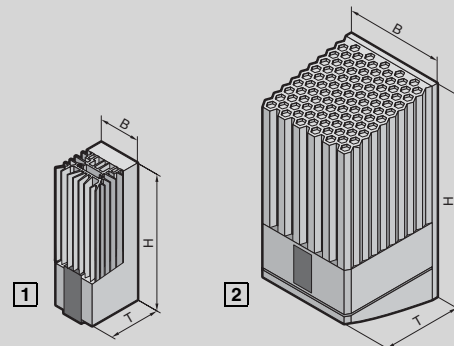

**1 Without fan, continuous thermal output 10 – 150 W**

Model No. SK		3105.310	3105.320	3105.330	3105.340	3105.350	3105.360	3105.370	Page
Dimensions mm	W (B)	45	45	64	64	64	90	90	
	H	120	120	155	155	230	165	180	
	D (T)	46	46	56	56	56	75	75	
Rated operating voltage V, Hz		110 – 240 V, 50/60 Hz							
<b>Continuous thermal output at T<sub>u</sub> = 10°C</b>		<b>8 – 10 W</b>	<b>18 – 20 W</b>	<b>23 – 30 W</b>	<b>49 – 50 W</b>	<b>63 – 75 W</b>	<b>86 – 100 W</b>	<b>130 – 150 W</b>	
Pre-fuse T		2 A	2 A	4 A	4 A	4 A	4 A	4 A	
<b>Accessories</b>	Packs of								
Enclosure internal thermostat	1	3110.000	3110.000	3110.000	3110.000	3110.000	3110.000	3110.000	294
Hygrostat	1	3118.000	3118.000	3118.000	3118.000	3118.000	3118.000	3118.000	294
Digital temperature display/thermostat	1	3114.200	3114.200	3114.200	3114.200	3114.200	3114.200	3114.200	293

Special voltages available on request. We reserve the right to make technical modifications.

**2 With fan, continuous thermal output 250 – 800 W**

Model No. SK		3105.410	3105.380	3105.420	3105.390	3105.430	3105.400	Page	
Dimensions mm	W (B)	103		103		103			
	H	200		200		200			
	D (T)	103		103		103			
Rated operating voltage V, Hz		110 V, 50/60 Hz	230 V, 50/60 Hz	110 V, 50/60 Hz	230 V, 50/60 Hz	110 V, 50/60 Hz	230 V, 50/60 Hz		
<b>Continuous thermal output at T<sub>u</sub> = 10°C</b>		<b>250 W<sup>1)</sup></b>		<b>400 W<sup>1)</sup></b>		<b>800 W<sup>1)</sup></b>			
Pre-fuse T		4 A	4 A	6 A	6 A	10 A	6 A		
<b>Accessories</b>	Packs of								
Enclosure internal thermostat	1	3110.000	3110.000	3110.000	3110.000	3110.000	3110.000	294	
Hygrostat	1	3118.000	3118.000	3118.000	3118.000	3118.000	3118.000	294	
Digital temperature display/thermostat	1	3114.200	3114.200	3114.200	3114.200	3114.200	3114.200	293	

<sup>1)</sup> Thermal output with fan.

Special voltages available on request. We reserve the right to make technical modifications.



# Climate control accessories

## Air routing

### Air duct system

#### for roof-mounted variants: cooling units and air/water heat exchangers

It is possible to route the cold air directly to specific areas of the enclosure using the air duct system. The risk of "short circuits" in the air circulation due to self-ventilated installed devices is therefore eliminated.

The dimensions of the shallow duct are W x H x D 229 x 1500 x 29 mm, and can be shortened to the required length.

#### Material:

Flame-resistant plastic to DIN 4102/B1

#### Supply includes:

Shallow duct, compensating hose.

#### Note:

Do not direct cold air straight at active components. When using the ducting system, the performance of the cooling unit may be reduced, depending on the application in question.



#### Also required:

TS support strips, see page 462.



#### Accessories:

- Deflector 90°, see page 291.
- Stopper, see page 292.

For unit	Packs of	Model No. SK
SK 3209... /SK 3210... /SK 3273... /SK 3359... /SK 3382... /SK 3383... /SK 3384... /SK 3385...	1	<b>3286.870</b>
SK 3386... /SK 3387...	1	<b>3286.970</b>

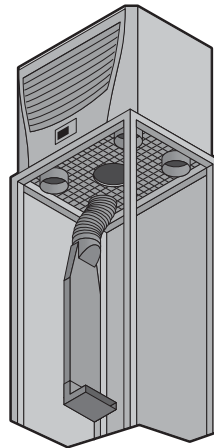

### Deflector, 90°

#### for air duct system

For targeted air deflection at the end of the shallow channel.

#### Material:

Flame-resistant plastic to DIN 4102/B1

Packs of	Model No. SK
1	<b>3286.990</b>



# Climate control accessories

## Air routing



### Shallow air duct system

**for roof-mounted variants:  
cooling units and air/water heat exchangers,  
to fit TS 8 enclosures from a width of 800 mm  
and a depth of 600 mm.**

It is possible to route the cold air directly to specific areas of the enclosure using the air duct system. The risk of "short circuits" in the air circulation due to self-ventilated installed devices is therefore eliminated.

The dimensions of the shallow duct are W x H x D 229 x 1500 x 29 mm, and can be shortened to the required length.

**Material:**

Flame-resistant plastic to DIN 4102/B1

**Supply includes:**

- Shallow duct
- Adaptor
- Compensating piece
- Deflector, 90°

**Note:**

Do not direct cold air straight at active components. When using the ducting system, the performance of the cooling unit may be reduced, depending on the application in question.



**Also required:**

- Shallow duct extension SK 3286.860 to compensate for the enclosure width and height.
- TS support strips, see page 462.



**Accessories:**

- Deflector 90°, see page 291.
- Stopper, see page 292.

For unit	Packs of	Model No. SK
SK 3209. ... /SK 3210. ... /SK 3273. ... /SK 3383. ... /SK 3384. ... /SK 3385. ...	1	<b>3286.850</b>

### Shallow duct extension

Extension kit for shallow air duct system SK 3286.850 for width, depth or height length extensions in TS 8 enclosures.

**Material:**

Flame-resistant plastic to DIN 4102/B1

Packs of	Model No. SK
1	<b>3286.860</b>

**Supply includes:**

- Shallow duct 1500 mm
- Connecting piece

### Stoppers

**for roof-mounted cooling units**

To cover unneeded cold air outlets in roof-mounted cooling units.

**Material:**

Polyurethane foam

For units	Max. no. of stoppers per unit	Packs of	Model No. SK
SK 3359. ... /SK 3382. ...	1	2	<b>3286.780</b>
SK 3209. ... /SK 3210. ... /SK 3273. ... /SK 3383. ... /SK 3384. ... /SK 3385. ...	2	2	<b>3286.880</b>
SK 3386. ... /SK 3387. ...	1	2	<b>3286.980</b>

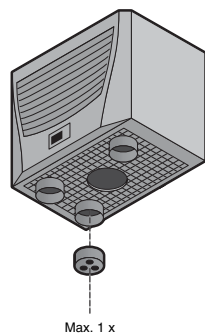

SK 3359. ... /SK 3382. ...  
SK 3386. ... /SK 3387. ...

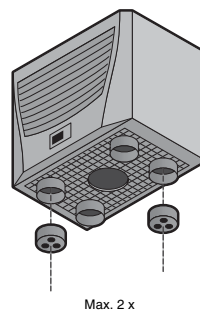

SK 3209. ... /SK 3210. ...  
SK 3383. ... /SK 3384. ...  
SK 3385. ... /SK 3273. ...

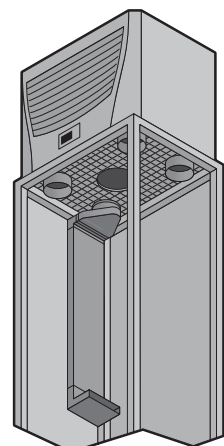

# Climate control accessories

## Air routing/control/regulation

### Air diverter

For use with wall-mounted cooling units.  
For targeted air routing of the cold air in a downward direction.  
Particularly well-suited for densely-packed electrical components in the lower section of the enclosure.

**Material:**  
Sheet steel

For units	Model No. SK
SK 3304.../SK 3305...	<b>3213.310</b>
SK 3328.../SK 3329...	<b>3213.320</b>
SK 3332...	<b>3213.330<sup>1)</sup></b>

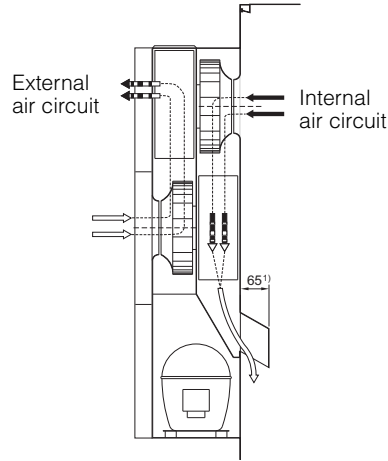

<sup>1)</sup> 115 mm for SK 3213.330



### Digital enclosure internal temperature display and thermostat

For installation in the enclosure door or wall.

#### Technical specifications:

- 2 voltage ranges for 100 – 230 V, 50/60 Hz and 24 – 60 V (DC)
- Depth: 100 mm
- Three-digit, 7-segment display
- Option of switching between °C/°F
- Temperature range: +5°C to +55°C
- Includes 1800 mm long NTC sensor
- Two relay outputs as change-over contact and normally open contact (max. contact load 230 V, 6 A)

Packs of	Model No. SK
1	<b>3114.200</b>

Special requirements can be accommodated on request.

- Freely selectable switching difference
- The freely adjustable setpoint values can be set using the membrane keyboard at the front  
Setting range: +5°C to +55°C
- Display and switching accuracy +/- 2 K
- The minimum and maximum recorded temperatures are stored until it is next reset



### Digital enclosure internal temperature display and thermostat

#### Integrated into a panel 1 U.

Including cable attachment for connection cable and label holder.

#### Technical specifications:

- 2 voltage ranges for 100 – 230 V, 50/60 Hz and 24 – 60 V (DC)
- Depth: 100 mm
- Three-digit, 7-segment display
- Option of switching between °C/°F
- Temperature range: +5°C to +55°C
- Includes 1800 mm long NTC sensor
- Two relay outputs as change-over contact and normally open contact (max. contact load 230 V, 6 A)

Packs of	Model No. DK
1	<b>7109.035</b>

Special requirements can be accommodated on request.

- Freely selectable switching difference
- The freely adjustable setpoint values can be set using the membrane keyboard at the front  
Setting range: +5°C to +55°C
- Display and switching accuracy +/- 2 K
- The minimum and maximum recorded temperatures are stored until it is next reset

**Colour:**  
RAL 7035



# Climate control accessories

## Control/regulation



### Enclosure internal thermostat

Especially suitable for controlling fan-and-filter units, heaters and heat exchangers, this thermostat can also be used as a signal generator for monitoring the enclosure internal temperature.

#### Technical specifications:

- Bi-metal controller as a temperature-sensitive element with thermal feedback.
- Contact population: Single-pole change-over contact as a quick-break contact.
- Permissible contact load:
  - Cat. 5 – 3 (heating)
  - AC 10 (4)<sup>1)</sup> A,
  - DC = max. 30 W
  - Cat. 5 – 4 (cooling)
  - AC 5 (4)<sup>1)</sup> A,
  - DC = max. 30 W
- <sup>1)</sup> = inductive load at  $\cos \varphi = 0.6$
- Setting range: +5°C to +60°C

Rated operating voltage	Model No. SK
230/115/60/48/24 V (AC)	3110.000
60/48/24 V (DC)	

- Weight: approx. 105 g
- Dimensions: 71 x 71 x 33.5 mm
- Switching difference: approx. 1 K ± 0.8 K.
- Flexible mounting on a vertical or horizontal 35 mm support rail to EN 50 022, and snap fastening in the TS/SE enclosure section or on the mounting plate using the supplied adaptor.

#### + Accessories:

Mounting plate TS with integral top-hat rail, see page 470.

### Hygrostat

The hygrostat switches on the heater and/or fan when a preset relative humidity in the enclosure is exceeded.

In this way, the relative humidity is raised above the dew point, and condensation on assemblies or electronic components is avoided.

#### Technical specifications:

- Contact population: Single-pole change-over contact as a quick-break contact.
- Permissible contact load:
  - AC ~ 5 (0.2)<sup>1)</sup> A
  - DC = max. 20 W
- <sup>1)</sup> = inductive load at  $\cos \varphi = 0.6$
- Setting range: 50 – 100 % relative humidity
- Weight: approx. 100 g
- Dimensions: 71 x 71 x 33.5 mm
- Switching difference: approx. 4%

Rated operating voltage	Model No. SK
24 – 230 V (AC), 24 – 75 V (DC)	3118.000

- Flexible mounting on a vertical or horizontal 35 mm support rail to EN 50 022, and snap fastening in the TS/SE enclosure section or on the mounting plate using the supplied adaptor.

#### + Accessories:

Mounting plate TS with integral top-hat rail, see page 470.

### Bottom-mounted adaptor

for enclosure internal thermostat SK 3110.000 and hygrostat SK 3118.000

Bottom-mounted adaptor with mounting option for screwed cable glands, for targeted cable infeed from appropriate equipment such as SK fan-and-filter units and enclosure heaters. In conjunction with screwed cable glands, it is also suitable for use as strain relief.

Packs of	Model No. SK
1	3110.200

### Control unit for EC fan-and-filter units

Temperature-dependent speed control for EC fan-and-filter units to reduce noise and save energy. The function of the fan can also be monitored.

- Activation and monitoring of up to 4 EC fan-and-filter units (caution: EC fan-and-filter units cannot be controlled with speed control 3120.200!)
- Rated operating voltage: 24 V (DC)
- Top-hat rail assembly
- Temperature setting range: +5°C to +55°C/41°F to 131°F
- External temperature sensor to record the ACTUAL temperature
- Status LED to display the operating status
- Alarm relay for reporting overtemperature, fan defect, cable interruption and sensor failure

For fan-and-filter units	Model No. SK
SK 3245.XXX	3235.440

**Supply includes:**  
NTC sensor, length 1.80 m.

# Climate control accessories

## Control/regulation

### Speed control

Temperature-dependent speed control for TopTherm fan-and-filter units and air/air heat exchangers for noise reduction and to save energy in part-load operation.

#### Technical specifications:

- For mounting on a 35 mm support rail DIN EN 50 022
- Dimensions (W x H x D): 105 x 90.5 x 60.2 mm
- Rated operating voltage: 100 – 230 V (AC)
- Setting range: +20°C to +55°C
- Phase cross-over with microcontroller
- Maximum fan output 300 W or 2 A

Packs of	Model No. SK
1	3120.200

#### Supply includes:

- Speed control
- NTC sensor, length 1.80 m.

#### Note:

Only suitable for use with 1-phase AC motors and equipment.



#### Accessories:

Mounting plate TS with integral top-hat rail, see page 470.



### Interface board

#### for equipment with e-Comfort controller

The interface board is an extension for equipment with e-Comfort controller. In this way it is possible, e.g. to monitor a master/slave combination of up to 10 cooling units in conjunction with a Rittal CMC III. Control is achieved via standardised interfaces: RS232 (DB9) or RS485, one PLC interface (DB9). RS422 (RJ 45 jack) is the connection to the Rittal CMC III. In this way, remote monitoring via TCP-IP, graphical interfaces for operation, evaluation and control, documentation, and connection to additional sensors for access control are possible. The extension board is built into a 1 U plastic housing.

A voltage supply of 24 V (DC) is required.

This may be supplied from the CMC III via a wide-range power pack DK 7320.425 (100 to 240 V (AC), 50/60 Hz) or externally via a Kycon connector.

Packs of	Model No. SK
1	3124.200

#### Supply includes:

- Interface board integrated into a plastic box W x H x D (mm): 136 x 44 (1 U) x 129
- Serial SUB-D cable, 1.5 m.

#### Note:

Networking and monitoring plan may be found on the relevant product page on the Internet, under "Download".



### SK BUS system

The SK bus system facilitates communications between several enclosure cooling units and air/water heat exchangers .500/.510/.540/.600/.610/.640. via a master/slave construction such as that required e.g. in complex bayed enclosure systems for optimum operating conditions.

#### Technical specifications:

The master/slave construction facilitates common activation and deactivation via door limit switches, parallel activation and deactivation via a temperature setpoint, and common collective fault signals and temperature logging, thereby eliminating the need for intricate wiring.

Packs of	Model No. SK
1	3124.100

#### Supply includes:

- 3 m shielded interface cable
- Operating instructions on programming the cooling units

#### Note:

- $n_B = n_K - 1$
- $n_B$ : Number of order units (SK bus system)
- $n_K$ : Number of cooling units to be linked

Networking and monitoring plan may be found on the relevant product page on the Internet, under "Download".

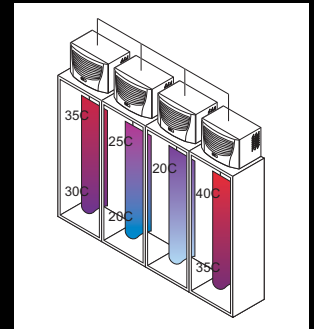

### Master/slave adaptor

#### for Thermoelectric Cooler

Parallel operation of up to 5 thermoelectric coolers to increase cooling output or for redundant use.

For units	Model No. SK
SK 3201.200, SK 3201.300	3201.070



#### Also required:

Per slave 1 x RJ 45 network cable DK 7320.470 or DK 7320.472, see page 596.



# Climate control accessories

## Mounting accessories

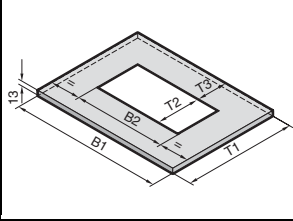

### Roof plates TS

For mounting:

- Roof-mounted units
- Air/water heat exchangers
- Roof-mounted fan
- Vent attachment TS

The cut-outs in the roof plate are arranged in such a way that the roof-mounted cooling units are positioned centrally on the enclosure.

**Material:**

Sheet steel

**Colour:**

RAL 7035

**Supply includes:**

Assembly parts.

For enclosures W (B) x D (T) mm	For mounting	B1 mm	B2 mm	T1 mm	T2 mm	T3 mm	Model No. TS
800 x 600	SK 3382. . . /SK 3359. . . / SK 3149.4 . . /SK 3149.8. . .	767.5	475	567.5	260	129.3	<b>8801.320</b>
600 x 600	SK 3209. . . /SK 3383. . . / SK 3210. . . /SK 3384. . . /	567.5	490	567.5	390	61.3	<b>8801.310<sup>1)</sup></b>
800 x 600	SK 3273. . . /SK 3385. . . / TS 8801.380	767.5	490	567.5	390	61.3	<b>8801.330</b>
1200 x 600		1167.5	490	567.5	390	61.3	<b>8801.350</b>
800 x 600	SK 3386. . . /SK 3387. . . .	767.5	692	567.5	392	57.8	<b>8801.340<sup>2)</sup></b>

<sup>1)</sup> When mounting the cooling units, there may be a collision with the eyebolts of the enclosure; for this reason, roof fastening screws are supplied loose with the roof plates.

<sup>2)</sup> Attachment is from the inside using metal brackets and retaining clamps.

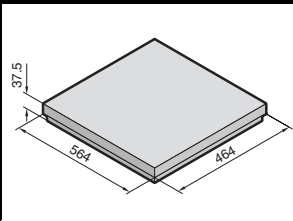

### Vent attachment TS

For passive ventilation with labyrinthine air flow routing, to match the roofs for roof-mounted cooling units.

**Colour:**

RAL 7035

**Protection category:**

IP 43

**Supply includes:**

Assembly parts.

For roof plates with cut-out	Model No. TS
490 x 390 mm	<b>8801.380</b>

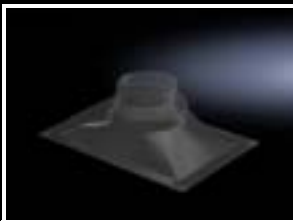

### Vent cover

The ideal addition for incorporating sealed racks into an existing central climate control system.

The stepped connection is suitable for standard pipe diameters 150 mm and 200 mm, thereby ensuring effective cooling thanks to targeted air exchange inside the rack.

**Design:**

Diameter of hose connection:

150 mm/200 mm

Maximum cut-out on roof plate:

380 mm x 230 mm

**Material:**

PET-G, transparent

**Supply includes:**

Assembly parts.

Width mm	Height mm	Depth mm	Packs of	Model No. DK
450	144	300	1	<b>7826.750</b>

Extended delivery times.



**Rittal service:**

Mounting on the enclosure on request.



# Climate control accessories

## Mounting accessories

### Trim frame

#### for slimline cooling units

Slimline cooling units can be internally or externally mounted on an enclosure door or wall. The trim frame presents a closed front for the cooling unit.

**Material:**

Sheet steel

**Colour:**

RAL 7035

For cooling unit	Model No. SK
SK 3366. . . .	<b>3377.000</b>

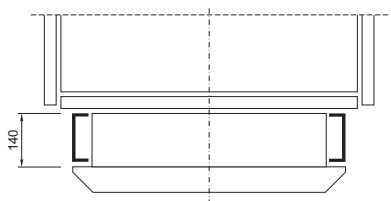

### Quick-change frame

#### for roof-mounted cooling units

The quick-change frame is more than just an alternate frame. Together with the seal, the lower part of the frame is screw-fastened to the enclosure. In this way, it is possible to install and remove the connector-ready cooling unit with the upper part of the quick-change frame previously mounted on the cooling unit with quick-release fasteners. During servicing work, this means shorter assembly times and hence minimised downtime. What is more, the quick-change frame offers effective protection against the ingress of oil into the enclosure in oily atmospheres, thanks to its integral drainage trough.

**Material:**

Sheet steel

**Colour:**

RAL 7035

**Supply includes:**

- Quick-change frame
- Seal
- Quick-release fasteners

For roof-mounted cooling units	Model No. SK
SK 3359. . . /SK 3382. . . .	<b>3286.700</b>
SK 3209. . . /SK 3210. . . / SK 3383. . . /SK 3384. . . / SK 3385. . . .	<b>3286.800</b>
SK 3301.800/SK 3386. . . / SK 3387. . . .	<b>3286.900</b>

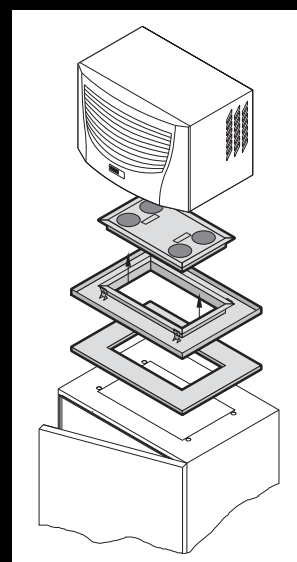

### Adjustable frame

#### for air/air heat exchangers, railway-compatible version

The adjustable frame allows variable partial installation of air/air heat exchangers on enclosures, to facilitate optimum space utilisation.

**Material:**

Sheet steel

**Colour:**

RAL 7035

For heat exchangers	Model No. SK
SK 3126.4. .	<b>3286.260</b>
SK 3128.4. . /SK 3129.4. .	<b>3286.270</b>
SK 3130.4. .	<b>3286.280</b>



# Climate control accessories

## Mounting accessories



### Adaptor frame for wall-mounted cooling units

To compensate for the rear tilt of the TP consoles.

**Material:**  
Sheet steel

**Surface finish:**  
– Powder-coated  
– Textured paint

**Colour:**  
RAL 7035

**Supply includes:**  
Assembly parts.

For cooling units 300 W	Packs of	Model No. TP
SK 3302.300/.310	1	<b>6730.600</b>

Extended delivery times.

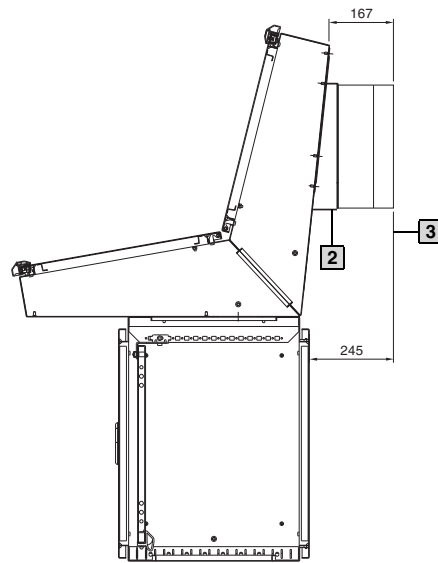

Mounting cut-out

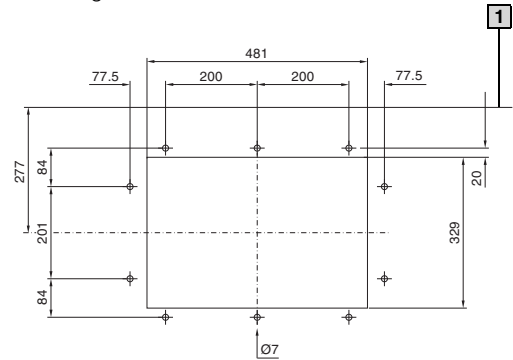

- 1** Top edge of console
- 2** Adaptor frame
- 3** Cooling units SK 3302.3X0



### Integrated louvres

For ventilation by convection; easily retro-fitted using 4 screws.

**Material:**  
Sheet steel

**Colour:**  
RAL 7035

W (B) x H x D (T) mm	Packs of	Model No. SK
160 x 110 x 8	4	<b>2541.235</b>
210 x 100 x 8	4	<b>2542.235</b>
330 x 110 x 8	4	<b>2543.235</b>

**Detailed drawing:**  
Available on the Internet.

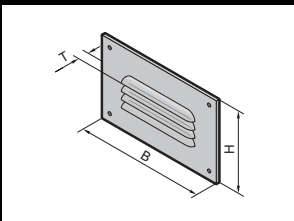

# Climate control accessories

## Filter technology

### Filter mats

#### for tangential fans

Made of chopped-fibre mat with a progressive structure. Temperature-resistant to 100°C, self-extinguishing category F1 to DIN 53 438. Dust-laden air side: Open structure. Clean air side: Closed structure. Reliable filtering of virtually all types of dust from a particle size of 10 µm.

#### Material:

Chemical fibre



For tangential fans/front outlet grilles 2 U	W x H x D mm	Packs of	Model No. SK
SK 3144.000/SK 3145.000/SK 3176.000	425 x 85 x 8	5	<b>3177.000</b>

### Filter mats

#### For

- Cooling units
- Air/air heat exchangers

Rittal cooling units are low-maintenance and are supplied without filter mats. Filter mats may be used for extreme conditions.

#### Material:

- Open-celled polyurethane foamed plastic
- Outstanding physical and mechanical properties
- Temperature-resistant from –40°C to +80°C
- Thickness: 10 mm



For cooling units	W x H x D mm	Packs of	Model No. SK
SK 3302.300/SK 3302.310	190 x 95 x 10	3	<b>3286.110</b>
SK 3302... /SK 3303... /SK 3361...	265 x 200 x 10	3	<b>3286.300</b>
SK 3304... /SK 3305... /SK 3328... /SK 3329... /SK 3332... /SK 3366...	344 x 268 x 10	3	<b>3286.400</b>
SK 3273... /SK 3382... /SK 3383... /SK 3384... /SK 3385... /SK 3359...	530 x 255 x 10	3	<b>3286.500</b>
SK 3386... /SK 3387...	720 x 300 x 10	3	<b>3286.600</b>
SK 3377...	205 x 210 x 10	3	<b>3253.010</b>

For discontinued cooling units	W x H x D mm	Packs of	Model No. SK
SK 3296... /SK 3272.100/SK 3290... /SK 3280.100/SK 3299... /SK 3261...	539 x 332 x 10	3	<b>3286.100</b>
SK 3265.100/SK 3266.100	270 x 332 x 10	3	<b>3267.100</b>
SK 3256...	395 x 300 x 10	3	<b>3254.000</b>
SK 3293... /SK 3281.100/SK 3298... /SK 3279.100/SK 3260... /SK 3269... /SK 3262.100/SK 3393... /SK 3381.100/SK 3391...	334 x 313 x 10	3	<b>3294.100</b>
SK 3255... /SK 3395...	350 x 245 x 10	3	<b>3253.000</b>
SK 3394...	315 x 200 x 10	3	<b>3285.000</b>
SK 3292.134/SK 3278.134	325 x 250 x 10	3	<b>3286.000</b>

For air/air heat exchangers	W x H x D mm	Packs of	Model No. SK
SK 3126.100/SK 3126.115	265 x 200 x 10	3	<b>3286.300</b>
SK 3127.100/SK 3127.115/SK 3128.100/SK 3128.115/SK 3129.100/SK 3129.115/SK 3130.100/SK 3130.115	344 x 268 x 10	3	<b>3286.400</b>

# Climate control accessories

## Filter technology



### Metal filters

Particularly when cooling units are used in dusty and damp environments, it is advisable to use washable metal filters.

If air or steam condenses on the metal surfaces, any particles that may be present will adhere to the metal and are easily washed out with water or grease-dissolving detergents.

#### Material:

- Aluminium
- Thickness: 10 mm

For cooling units	W x H x D mm	Packs of	Model No. SK
SK 3302.300/SK 3302.310	190 x 95 x 10	1	<b>3286.120</b>
SK 3302.100/SK 3302.110/SK 3303. . . /SK 3361. . . .	265 x 200 x 10	1	<b>3286.310</b>
SK 3304. . . /SK 3305. . . /SK 3328. . . /SK 3329. . . /SK 3332. . . /SK 3366. . . .	344 x 268 x 10	1	<b>3286.410</b>
SK 3273. . . /SK 3382. . . /SK 3383. . . /SK 3384. . . /SK 3385. . . /SK 3359. . . .	530 x 255 x 10	1	<b>3286.510</b>
SK 3386. . . /SK 3387. . . .	720 x 300 x 10	1	<b>3286.610</b>
SK 3377. . . .	225 x 200 x 10	1	<b>3253.220</b>
For discontinued cooling units	W x H x D mm	Packs of	Model No. SK
SK 3296. . . /SK 3272.100/SK 3290. . . /SK 3280.100	520 x 290 x 10	1	<b>3286.210</b>
SK 3299. . . /SK 3261. . . .	520 x 315 x 10	1	<b>3286.200</b>
SK 3265.100/SK 3266.100	265 x 320 x 10	1	<b>3267.200</b>
SK 3256. . . .	315 x 365 x 10	1	<b>3254.200</b>
SK 3293. . . /SK 3281.100/SK 3298. . . /SK 3279.100/SK 3260. . . /SK 3269. . . /SK 3262.100/SK 3393. . . /SK 3381.100/SK 3391. . . .	300 x 328 x 10	1	<b>3294.200</b>
SK 3255. . . /SK 3395. . . .	348 x 210 x 10	1	<b>3253.200</b>
SK 3394. . . .	375 x 415 x 10	1	<b>3285.200</b>
For climate control door/section door	W x H x D mm	Packs of	Model No. SK
SK 3300.040/SK 3300.050/SK 3300.060/SK 3300.070/SK 3300.080/SK 3300.090/SK 3300.110/SK 3300.120	425 x 78 x 10	1	<b>3284.210</b>
For discontinued climate control doors	W x H x D mm	Packs of	Model No. SK
SK 3306. . . /SK 3307. . . /SK 3309. . . /SK 3310. . . .	424 x 100 x 10	1	<b>3284.200</b>
SK 3308. . . .	624 x 100 x 10	1	<b>3288.200</b>
For discontinued climate control side panel	W x H x D mm	Packs of	Model No. SK
SK 3331. . . .	380 x 150 x 10	1	<b>3289.200</b>
For air/air heat exchangers	W x H x D mm	Packs of	Model No. SK
SK 3126.100/SK 3126.115	265 x 200 x 10	1	<b>3286.310</b>
SK 3127.100/SK 3127.115/SK 3128.100/SK 3128.115/SK 3129.100/SK 3129.115/SK 3130.100/SK 3130.115	344 x 268 x 10	1	<b>3286.410</b>
For air/air heat exchangers, wall-mounted, railway-compatible version	W x H x D mm	Packs of	Model No. SK
SK 3126.4XX	130 x 130 x 10	1	<b>3286.230</b>
SK 3128.4XX/SK 3129.4XX	208 x 208 x 10	1	<b>3286.240</b>
SK 3130.4XX	225 x 225 x 10	1	<b>3286.250</b>
For recooling systems	W x H x D mm	Packs of	Model No. SK
SK 3318.600/SK 3318.610/SK 3319.600/SK 3319.610	530 x 255 x 10	1	<b>3286.510</b>
SK 3320.600/SK 3334.600	500 x 558 x 8	1	<b>3286.520</b>
SK 3360. . . .	344 x 268 x 10	1	<b>3286.410</b>
For chillers	W x H x D mm	Packs of	Model No. SK
SK 3335.590/SK 3335.600	600 x 800 x 20	1	<b>3286.550</b>
SK 3335.610/SK 3335.620/SK 3335.650	600 x 1050 x 20	1	<b>3286.530</b>
SK 3335.630/SK 3335.640/SK 3335.660	1000 x 1035 x 20	1	<b>3286.540</b>

# Climate control accessories

## Filter technology

### Lint screen

Especially for the use of cooling units and air/air heat exchangers where there is a high proportion of lint in the ambient air.

**Material:**

Stainless steel mesh

For units	Packs of	Model No. SK
SK 3304.../SK 3305.../ SK 3328.../SK 3329.../ SK 3332.../SK 3360.../ SK 3126.../SK 3127.../ SK 3128.../SK 3129.../ SK 3130...	1	<b>3329.904</b>

Extended delivery times.



**Also required:**

Louvred grille for lint screen.



### Louvred grille for lint screen

**Material:**

ABS

For lint screen	Packs of	Model No. SK
SK 3329.904	1	<b>3329.903</b>

Extended delivery times.



### Spare filter mats

Made of chopped-fibre mat with a progressive structure. Temperature-resistant to +100°C, self-extinguishing category F1 to DIN 53 438.

Dust-laden air side: Open structure.

Clean air side: Closed structure.

Reliable filtering of virtually all types of dust from a particle size of 10 µm.

For thermoelectric cooler	Material	Filter class to DIN EN 779	Packs of	Model No. SK
SK 3201.200/SK 3201.300	Chemical fibres	G2	5	<b>3201.050</b>

For fan-and-filter units	Material	Filter class to DIN EN 779	Packs of	Model No. SK
SK 3237...	Chemical fibres	G2	5	<b>3321.700</b>
SK 3238...		G2	5	<b>3322.700</b>
SK 3239...		G3	5	<b>3171.100</b>
SK 3240.../SK 3241...		G3	5	<b>3172.100</b>
SK 3243.../SK 3244...		G3	5	<b>3173.100</b>

For discontinued fan-and-filter units/ outlet filters	Material	Filter class to DIN EN 779	Packs of	Model No. SK
SK 3321...	Chemical fibres	G2	5	<b>3321.700</b>
SK 3322...		G2	5	<b>3322.700</b>
SK 3323...		G3	5	<b>3171.100</b>
SK 3324.../SK 3325...		G3	5	<b>3172.100</b>
SK 3326...		G3	5	<b>3173.100</b>
SK 3327...	G3	5	<b>3327.700</b>	

For filter holders	Material	Filter class to DIN EN 779	Packs of	Model No. SK
SK 3175.000	Chemical fibres	G2	3	<b>3174.000</b>

For EMC fan-and-filter units	Material	Filter class to DIN EN 779	Packs of	Model No. SK
SK 3237...	Copper-nickel coated chemical fibres	G2	5	<b>3237.066<sup>1)</sup></b>
SK 3238...		G2	5	<b>3238.066<sup>1)</sup></b>
SK 3239...		G3	5	<b>3239.066<sup>1)</sup></b>
SK 3240.../SK 3241...		G3	5	<b>3240.066<sup>1)</sup></b>
SK 3243.../SK 3244.../SK 3245...		G3	5	<b>3243.066<sup>1)</sup></b>

<sup>1)</sup> To achieve the shielding/dampening properties of EMC fan-and-filter units.



# Climate control accessories

## Filter technology/general



### Fine filter mats

#### for fan-and-filter units

Made of chopped-fibre mat with a progressive structure. Temperature-resistant to +100°C, self-extinguishing category F1 to DIN 53 438. Dust-laden air side: Open structure. Clean air side: Closed structure. Reliable filtering of virtually all types of dust from a particle size of 10 µm.

#### Material:

Chemical fibre

For fan-and-filter units	Filter class to DIN EN 779	Packs of	Model No. SK
SK 3238. . . .	F5	5	<b>3238.055</b>
SK 3239. . . .	F5	5	<b>3181.100</b>
SK 3240. . . ./SK 3241. . . .	F5	5	<b>3182.100</b>
SK 3243. . . ./SK 3244. . . ./SK 3245. . . .	F5	5	<b>3183.100</b>

For discontinued fan-and-filter units/outlet filters	Filter class to DIN EN 779	Packs of	Model No. SK
SK 3323. . . .	F5	5	<b>3181.100</b>
SK 3324. . . ./SK 3325. . . .	F5	5	<b>3182.100</b>
SK 3326. . . ./SK 3327. . . .	F5	5	<b>3183.100</b>



### Auto Range power pack 240 W

#### for 24 V (DC) components

For power supply e.g. to DC fan-and-filter units or the Thermoelectric Cooler SK 3201.300 with primary 115/230 V (AC) voltage supply input.

#### Technical specifications:

- Approvals: CE, UL-listed
- Dimensions W x H x D: 83 x 125 x 116 mm
- Operating temperature range: -10°C to +71°C
- Snaps onto a 35 mm top-hat rail

Packs of	Model No. SK
1	<b>3201.040</b>



### Electric condensate evaporator

For external mounting on enclosures. For use with all enclosure cooling units and air/water heat exchangers.

Evaporation performance:

- 1) 2.4 l/d
- 2) 4.2 l/d

#### Colour:

RAL 7035

#### Supply includes:

Electric condensate evaporator, ready to connect.

For cooling units	Rated operating voltage	Model No. SK
SK 3302. . . ./SK 3303. . . .	230 V, 50/60 Hz	<b>3301.560<sup>1)</sup></b>
	115 V, 50/60 Hz	<b>3301.580<sup>1)</sup></b>
400 mm wide	230 V, 50/60 Hz	<b>3301.570<sup>2)</sup></b>
	115 V, 50/60 Hz	<b>3301.590<sup>2)</sup></b>

#### Detailed drawings:

Available on the Internet.

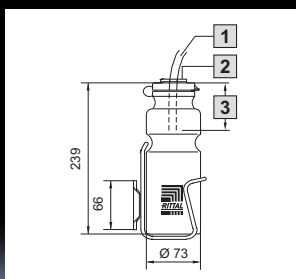

### Condensate collecting bottle

For mounting on the enclosure. For use with all enclosure cooling units and air/water heat exchangers. Safety overflow at the side. Capacity approximately 0.75 l.

- 1** Condensate discharge tube
- 2** Membrane grommet
- 3** Max. 70 mm

Packs of	Model No. SK
1	<b>3301.600</b>

#### Supply includes:

- Condensate collecting bottle
- Bottle holder
- Assembly parts

### Condensate hose

For removing and directing condensate.  
For connecting to enclosure cooling units.

**Material:**

PVC, transparent

For units	Hose length	Material thickness Ø	Model No. SK
SK 3201. . . .	5 m	6 x 1 mm	<b>3301.606</b>
SK 3302. . . /SK 320. . . .	10 m	8 x 1.5 mm	<b>3301.608</b>
SK 3303. . . /SK 3361. . . .	10 m	10 x 1.5 mm	<b>3301.610</b>
SK 3273. . . /SK 3304. . . /SK 3305. . . /SK 3328. . . / SK 3329. . . /SK 3332. . . /SK 3359. . . /SK 3366. . . / SK 3377. . . /SK 3382. . . /SK 3383. . . /SK 3384. . . / SK 3385. . . /SK 3386. . . /SK 3387. . . .	10 m	12 x 2 mm	<b>3301.612</b>



### Outlet filters

For ventilation by convection, an outlet filter can be installed in the upper and lower sections of the enclosure.

**Material:**

ABS,  
material resistance to UL 94-5VA.

**Colour:**

RAL 7035

**Supply includes:**

- Outlet filter
- Filter mat

Dimensions W x H x D in mm	Model No. SK	
	Standard	EMC
116.5 x 116.5 x 16	<b>3237.200</b>	<b>3237.060</b>
148.5 x 148.5 x 24	<b>3238.200</b>	<b>3238.060</b>
204 x 204 x 24	<b>3239.200</b>	<b>3239.060</b>
255 x 255 x 25	<b>3240.200</b>	<b>3240.060</b>
323 x 323 x 25	<b>3243.200</b>	<b>3243.060</b>



**Accessories:**

- Spare filter mats, see page 301.
- Fine filter mats, see page 302.

### Hose-proof hood

For fan-and-filter units/outlet filters. Easy cleaning thanks to exterior silicon coating approved for use with foodstuffs. When mounted over the fan-and-filter unit and outlet filter, a protection category of IP 56 to IEC 60 529 is achieved.

**Material:**

- Stainless steel
- Silicone

**Protection category:**

- In conjunction with the fan-and-filter units/ outlet filters, NEMA 3R + 12 is met.
- Protection category is met by type 1, 12, 3, 3R, 4, 4X.
- With SK 3237.080 and SK 3245.080, the protection category is only met by type 1, 12, 3R.

For fan-and-filter units	Dimensions mm	Model No. SK
SK 3237. . . .	150 x 230 x 40	<b>3237.080</b>
SK 3238. . . .	176 x 245 x 55	<b>3238.080</b>
SK 3239. . . .	233 x 330 x 55	<b>3239.080</b>
SK 3240. . . /SK 3241. . . .	282 x 390 x 85	<b>3240.080</b>
SK 3243. . . /SK 3244. . . .	350 x 480 x 110	<b>3243.080</b>
SK 3245. . . .	350 x 480 x 160	<b>3245.080</b>



### Blanking cover

If existing mounting cut-outs for fan-and-filter units/outlet filters need to be closed to achieve a higher protection category, the filter mat of the fan-and-filter unit/outlet filter can simply be replaced with a blanking cover; welding or other mechanical modification of the enclosure is not necessary.

**Material:**

Plastic

**Protection category:**

IP 54

For fan-and-filter units/ outlet filters	Packs of	Model No. SK
SK 3237. . . .	2	<b>3237.020</b>
SK 3238. . . .	2	<b>3238.020</b>
SK 3239. . . .	2	<b>3239.020</b>
SK 3240. . . /SK 3241. . . .	2	<b>3240.020</b>
SK 3243. . . /SK 3244. . . .	2	<b>3243.020</b>



# Climate control accessories

## General



### Front outlet grille 2 U

#### for tangential fans

This front outlet grille is required if a 482.6 mm (19") cross-flow blower (SK 3144.000/SK 3145.000) is used in the lower section of the electronic enclosure and the hot air is to be expelled to the outside from the upper section of the enclosure. The design of the grille matches that of the intake grille in the cross-flow blower. These grilles can also be used as simple inflow and outflow grilles with natural convection.

Packs of	Model No. SK
1	3176.000

#### + Accessories:

Filter mat, see page 299.



### Filter holder

#### for roof ventilation

The use of a filter mat is required in order to increase the protection category of the roof vent (SK 3148.007). Protection category IP 44 to IEC 60 529 is achieved.

**Material:**  
Sheet steel

**Supply includes:**  
Filter holder including filter mat.

W x H x D mm	Model No. SK
340 x 244 x 15	3175.000

#### + Accessories:

Spare filter mat, see page 301.



### Overflow valve

Pressostat for use in the water cycle between the recooling system and the air/water heat exchanger. It prevents an increase in pump pressure in the recooling system against the closed magnetic valve of the air/water heat exchanger outside of the cooling cycle.

**Setting range:**  
2 – 12 bar

**Presetting:**  
3 bar

**Material:**  
Brass

Design	Packs of	Model No. SK
1/2" bypass valve	1	3301.900
3/4" bypass valve	1	3301.910
1" bypass valve	1	3301.920



### Flow regulator valve

For use with air/water heat exchangers, especially if more than one heat exchanger ( $n > 1$ ) is used in the water cooling circuit. The correctly set valve then ensures the same quantity of cooling medium for all equipment. The valve is used for hydraulic balancing.

**Setting range:**  
3 – 12 l/min

**Material:**  
Brass

Design	Packs of	Model No. SK
3/4" x 1/2" for volumetric flow control	1	3301.930
3/4" x 3/4" for volumetric flow control	1	3301.940



### Threaded adaptor for quick-release fastener

For use with air/water heat exchangers with quick-release fastener. This threaded adaptor enables simple adaptation to fixed and flexible pipework.

**Material:**  
Brass

For units	Design	Packs of	Model No. SK
SK 3363.../ SK 3364.../ SK 3373.../ SK 3374.../ SK 3375...	G3/8" internal thread	2	3201.900
	G3/8" external thread	2	3201.910

Stainless steel V4A version available on request.



### Cooling medium for recooling systems

#### Ready mix

Apart from the recooling systems for oil and emulsion, all other recooling systems are only suitable for the cooling of water or a water/glycol mixture.

As well as protecting against frost, this cooling medium also serves to inhibit bacterial growth and provide optimum corrosion protection.

#### Supply includes:

- 10 l canister
- 25 l canister
- 200 l barrel

Cooling medium	Antifreeze/ water mixture	Container	Model No. SK
Outdoor	1 : 2	10 l	<b>3301.950</b>
		25 l	<b>3301.955</b>
		200 l	<b>3301.957<sup>1)</sup></b>
Standard	1 : 4	10 l	<b>3301.960</b>
		25 l	<b>3301.965</b>
		200 l	<b>3301.967<sup>1)</sup></b>

<sup>1)</sup> Extended delivery times.



### Connection kit

for connecting the CRAC system CW to the customer's pipework when using water as a cooling medium.

The connection kit is preassembled and is connected to an outgoing pipe with stop valve (to be provided by the customer) in both the inlet and outlet.

#### Supply includes:

##### Inlet side in direction of flow

High-pressure hose for flexible connection to the CRAC system CW.

##### Return side in direction of flow

High-pressure hose for flexible connection to the CRAC system CW.

For CRAC system CW	Nominal width	Model No. SK
SK 3301.620 to 3301.650	1"	<b>3300.260</b>
SK 3301.660 to 3301.690	1 1/4"	<b>3300.261</b>
SK 3301.830 to 3301.860	1 1/2"	<b>3300.262</b>
SK 3301.870 to 3301.990	2"	<b>3300.263</b>



### Energy-saving extractor plenum

for top-mounting on CRAC systems CW/DX.

The extractor plenum is used to raise the extraction height of the return air and return it to the CRAC system CW/DX at the highest possible temperature level. In this way, the energy efficiency of the unit can be increased significantly. The extractor plenum is comprised of an empty enclosure tailored to the width and depth of the CRAC system CW/DX. The equipment enclosure and extractor plenum are screw-fastened together using the assembly kit supplied loose.

#### Supply includes:

Empty enclosure including assembly kit.

For CRAC system CW/DX	Height mm	Model No. SK
SK 3301.620 to 3301.650	550	<b>3300.290</b>
SK 3301.660 to 3301.690	550	<b>3300.291</b>
SK 3301.830 to 3301.860	550	<b>3300.292</b>
SK 3301.870 to 3301.990	550	<b>3300.293</b>
SK 3300.510 to 3300.540	550	<b>3300.294</b>
SK 3300.560 to 3300.590	550	<b>3300.295</b>
SK 3300.710 to 3300.740	550	<b>3300.296</b>
SK 3300.760 to 3300.790	550	<b>3300.297</b>

#### Note:

Special heights to adapt to the available room height are available on request.

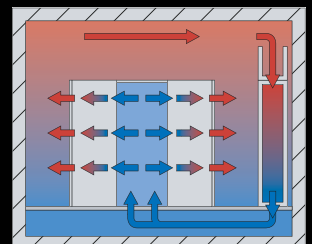



# IT infrastructure

## IT competence

System overview – Wall-mounted/floor-standing network enclosures .....	311
System overview – Server enclosures .....	313
System overview – Power .....	315
System overview – Cooling .....	317
System overview – Monitoring .....	319
System overview – Security solutions .....	321





1

8

2

9

3

10

7

# IT competence

## Wall-mounted/floor-standing network enclosures

Wall-mounted enclosures .....	53
Network enclosures .....	79

## Server enclosures

Server enclosures .....	91
-------------------------	----

## Power

UPS systems .....	189
Power Distribution Rack .....	200
Power System Module Plus .....	201
Power System Module .....	202
RiCell Flex fuel cell system .....	205

## Cooling

Chillers for IT cooling .....	272
CRAC system .....	274
Aisle containment .....	278
Liquid Cooling Package .....	279

## Monitoring

Monitoring system CMC III .....	578
Door control system .....	589
Monitor/keyboard unit .....	590
KVM switches .....	591
Dynamic Rack Control .....	597

## Security solutions

Compact data centre .....	321
Data Centre Container .....	327
Fire alarm and extinguisher system .....	328
Security rooms .....	331

## Software

RiZone .....	345
--------------	-----

## Your benefits

- Standardised server racks and network enclosures
- Modular power distribution and back-up
- Scalable IT cooling concepts
- High-MTBF IT security rooms, including certificates
- Complete system accessories for IT environments and data centres
- Software-based IT and infrastructure management system

## Sample applications

- 1 Wall-mounted enclosures, see page 53
- 2 Network enclosures, see page 79
- 3 Server enclosures, bayed in combination with LCP, see page 94/279
- 4 Power distribution
- 5 UPS systems, see page 189
- 6 Power Distribution Rack, see page 200
- 7 Chillers for IT cooling, see page 272
- 8 Monitoring system CMC III, see page 578
- 9 Compact data centre, see page 321
- 10 Data Center Container, see page 327





1

2

3

4

6

5

5

# Wall-mounted/floor-standing network enclosures



## Wall-mounted network enclosures

VerticalBox .....	54
FlatBox with 482.6 mm (19") mounting angles .....	55
FlatBox with 482.6 mm (19") mounting frame .....	56
QuickBox with glazed door .....	57
QuickBox with sheet steel door .....	58
QuickBox with vertical 482.6 mm (19") level .....	59
Wall-mounted enclosures EL, 3-part, depth 573/673 mm, pre-configured .....	60
Wall-mounted enclosures EL, 3-part, depth 473 mm, with punched rails .....	61
Wall-mounted enclosures EL, 3-part, depth 373 mm, with mounting plate .....	62
Wall-mounted enclosures EL, 3-part, depth 473 mm, with mounting plate .....	63
Wall-mounted enclosures EL, 2-part, depth 369 mm, with swing frame .....	64
Wall-mounted enclosures AE with 482.6 mm (19") mounting angles .....	65
Wall-mounted enclosures AE with 482.6 mm (19") pull-out frame .....	66
Small fibre-optic distributors .....	67

## Floor-standing network enclosures

### Network enclosures TS 8

Pre-configured, doors unvented .....	80
Pre-configured, doors vented .....	81
Pre-configured, doors/rear wall unvented .....	82
Pre-configured, doors unvented, divided .....	82
Network enclosures TS 8 .....	83

### Network enclosures TE 7000

Pre-configured .....	85
600 mm width .....	86
800 mm width .....	87

### Distributor racks

TE 7000 open .....	88
Data Rack .....	89

## Your benefits

### Network enclosures

- Network enclosures for stand-alone installation and data centres
- Complete system solutions for small to large networks
- Maximum configuration diversity and protection for installed equipment
- Investment protection and flexibility thanks to simple conversions and use of the comprehensive modular system

### Wall-mounted enclosures

- The right enclosure to suit all applications – up to protection category IP 55
- Sizes available from 3 U to 21 U
- Wide choice of accessories with "Rittal – The System."
- Fast assembly, conversion and simple installation based on the modular principle

## Sample applications

- 1 Wall-mounted enclosures EL, see page 60
- 2 FlatBox, see page 55
- 3 QuickBox wall-mounted enclosure with vertical 482.6 mm (19") level, see page 59
- 4 QuickBox wall-mounted enclosure with glazed door, see page 57
- 5 TE 7000 network enclosure with base/plinth and installation accessories, see page 85
- 6 TS 8 network enclosures, bayed with base/plinth, roof-mounted fan and installation accessories, see page 80





# Server enclosures

## Server enclosures

Server enclosures TS 8 .....	92
TS 8 server enclosures, colocation .....	93
TS 8 server enclosures for High Performance Cooling systems HPC .....	94
Server enclosures TE 7000 .....	95

## Your benefits

- Broad spectrum of sizes
- Integrated system, from small server racks to bayed rack suites in the data centre
- First-class finish for maximum protection
- High-quality lock systems for optimum access protection
- Comprehensive, system-compatible complete range for cooling, power distribution/power backup and monitoring



## Sample applications

- 1** TS 8 server enclosures in combination with aisle containment and LCP, see page 278
- 2** TS 8 server enclosures, colocation, see page 93
- 3** TS 8 server enclosures in combination with LCP, see page 94

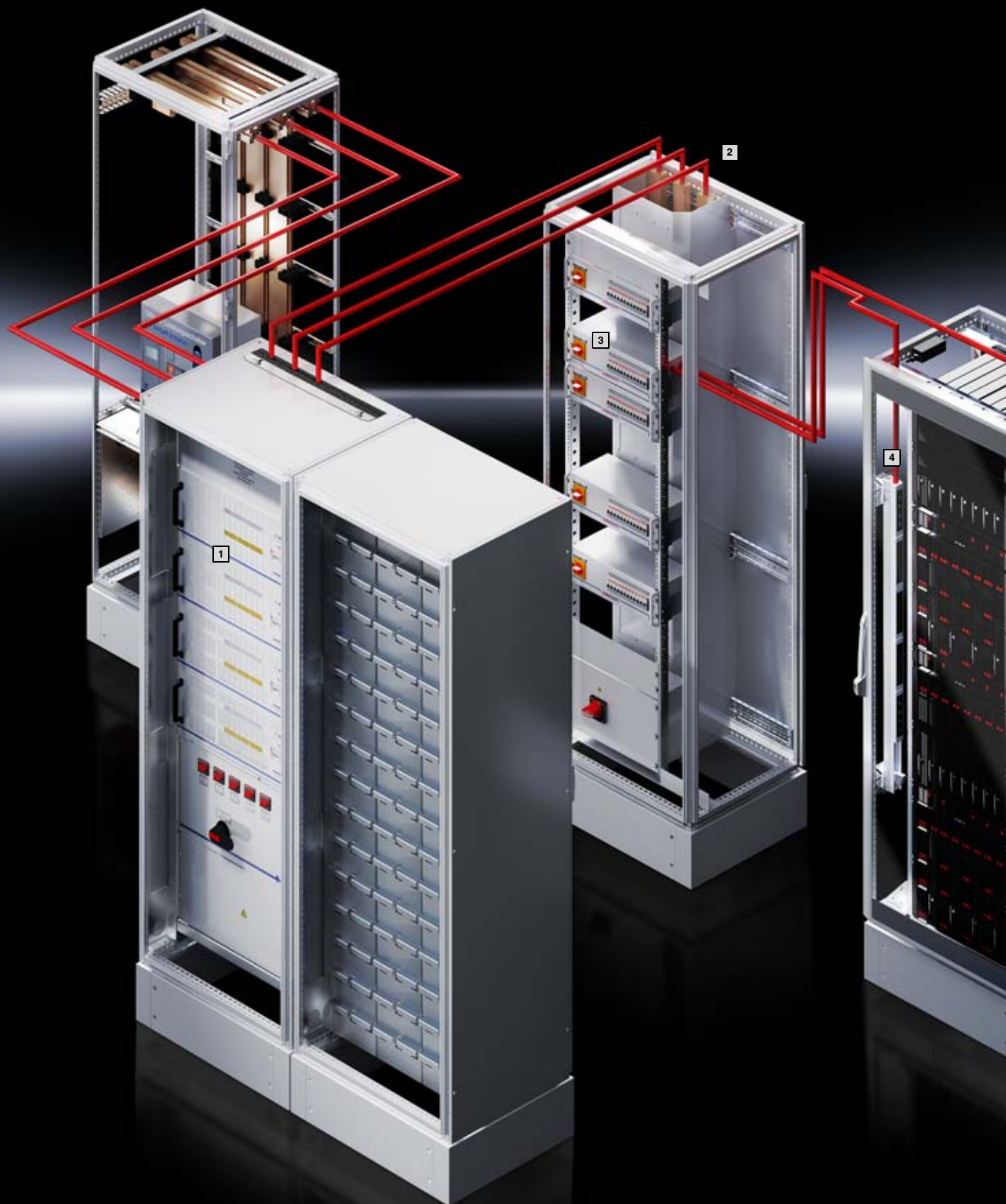

# Power

## UPS systems

UPS PMC 12 .....	190
UPS PMC 40 (type 1-4) .....	191
UPS PMC 40 (type 5) .....	192
UPS PMC 120 .....	193
UPS PMC 200 .....	194
UPS PMC 800 .....	195
UPS PMC accessories .....	196

## Power Distribution Rack

Power Distribution Rack .....	200
Power Distribution Module .....	200

## Power System Module

PSM Plus busbar .....	201
PSM Plus plug-in modules .....	201
PSM busbars .....	202
PSM socket modules .....	203
PSM accessories .....	204

## Fuel cell system

RiCell Flex fuel cell system .....	205
------------------------------------	-----

## Your benefits

- Holistic, systematic energy management concepts
- Comprehensive, complete solutions for power distribution and back-up, consistently modular, and flexibly extendible at any time
- Optimum energy and cost efficiency with maximum availability of the entire system
- Reduced costs for installation, administration and manpower
- High level of investment certainty
- All from a single source!

## Sample applications

- 1 Power Modular Concept PMC 200, see page 194
- 2 Power Distribution Rack PDR, see page 200
- 3 Power Distribution Module PDM, see page 200
- 4 Power System Module PSM, see page 201



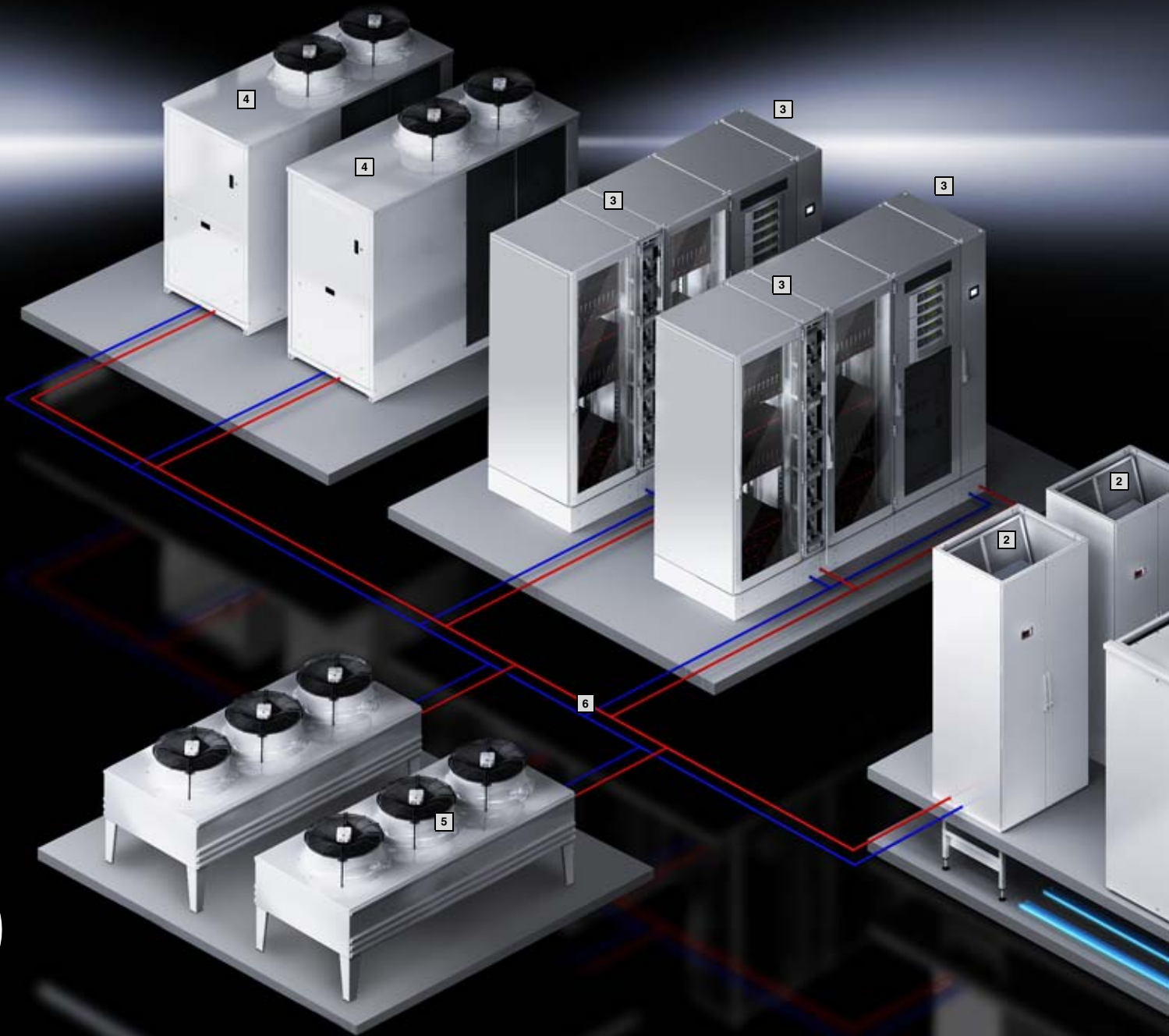

# Cooling

## Chillers for IT cooling

Chillers for IT cooling.....	15 – 123 kW.....	272
Chillers for IT cooling.....	155 – 481 kW.....	273

## CRAC system

CRAC system CW.....	27.8 – 137.4 kW.....	274
CRAC system DX.....	19.2 – 56.2 kW.....	276

## Aisle containment

Aisle containment.....		278
------------------------	--	-----

## Liquid Cooling Package

TopTherm LCP Rack CW and DX.....	up to 60 kW.....	279
TopTherm LCP Inline CW and DX.....	up to 60 kW.....	280
TopTherm LCP T3+ CW.....	up to 25 kW.....	281
TopTherm LCP Passive CW.....	20 kW.....	282
Accessories.....		283

## Your benefits

- State-of-the-art climate control technology, from cooling a single rack through to entire data centres
- Individual climate control concepts for rack, suite and room cooling
- Enhanced security plus superior energy and cost efficiency
- Optimisation with aisle containment and cross-system control concepts
- Energy-efficient cooling with IT chillers
- Minimises operating costs with free cooling
- Environmentally friendly thanks to resource and CO<sub>2</sub> savings
- Planning, assembly, commissioning and servicing – all from a single supplier!



## Sample applications

- 1 Rittal aisle containment, see page 278
- 2 CRAC systems, see page 274
- 3 Liquid Cooling Package LCP, see page 279
- 4 IT chiller, see page 272
- 5 Free cooling
- 6 Pipework
- 7 Raised floor for cold air supply



4

2

1

1

8

3

5

6

7

# Monitoring

## Monitoring system CMC III

CMC III system representation .....	578
CMC III system overview .....	580
CMC III Processing Unit/Compact .....	582
CMC III sensors .....	583
CMC III accessories .....	584

## Door Control System

Door Control System .....	588
---------------------------	-----

## Monitor/keyboard unit

Monitor/keyboard unit .....	590
-----------------------------	-----

## KVM switches

SSC view 8 USB, SSC view 32 Cat, SSC compact 32 Cat .....	591
SSC premium 2/16, 4/32, 8/32 .....	592
SSC Duo 16 .....	593

## Dynamic Rack Control

RFID mounting frame, tags, controller .....	597
---	-----

## Software

RiZone .....	345
--------------	-----

## Your benefits

- Overview of your IT infrastructure
- Enhanced security
- Automated processes
- High cost efficiency
- Enormous energy savings
- Simple project management
- Fast installation
- Flexible, individual solutions with standard products from Rittal
- High standard of quality with coordinated standard products

## Sample applications:

- 1** CMC III, see page 581
- 2** Power System Module PSM, Power Control Unit PCU  
incl. current measurement see page 201
- 3** Liquid Cooling Package LCP, see page 279
- 4** Connection of up to 10 cooling units with Comfort control via one unit
- 5** Sensors/actuators, see page 583
  - Temperature sensor
  - Humidity sensor
  - Access and vandalism sensors
  - Motion detectors
  - Airflow monitors
  - Smoke detectors
  - Voltage monitor
  - Power supply
  - Leaks
- 6** Monitor/keyboard unit, see page 590
- 7** Electric comfort handle TS 8, see page 415
- 8** Fire alarm and extinguisher system DET-AC XL, see page 329





1

2



# Security solutions

## Compact data centre

Basic Safe .....	322
Modular Safe .....	323
Modular Safe Extend .....	324
Climate control for Modular Safe/Modular Safe Extend .....	325

## Data Centre Container DCC

Data Centre Container DCC .....	327
---------------------------------	-----

## Fire alarm and extinguisher system

DET-AC Plus .....	328
DET-AC XL .....	329

## Security rooms

Data centres .....	331
--------------------	-----



## Sample applications

- 1** Modular Safe with climate control, see page 323, 325
- 2** Basic Safe with CMC and extinguisher system, see page 322
- 3** Modular Safe Extend as compact data centre, see page 324

# Basic Safe



System accessories Page 355

### Applications:

- Micro data centre for small businesses
- Protection for servers and storage applications
- Protection for business-critical data
- Storage of personal data, e.g. doctors' surgeries or tax advisors

### Benefits:

- Complete system with built-in climate control
- High level of operational and service-friendliness thanks to the two-door system
- Compatibility with other infrastructure elements

### Protection standards:

- Fire protection F90 based on DIN 4102
  - Compliance with limit values  $\Delta T < 50$  K, relative humidity  $< 85\%$  for 10 minutes
  - Tested burglary protection WK 2 EN 1627
  - Protection against dust and water jets IP 55 to IEC 60 529
- The tests were performed as system tests and confirmed by way of test reports.

### Material:

Pladur plate

### Colour:

Enclosure: RAL 7035

### Supply includes:

- Security enclosure with operating and service doors (three-point locking)
- Cable entry in both side elements
- Climate control 2.4 kW

### Detailed drawings:

Available on the Internet.

Photo shows a configuration example with equipment not included in the scope of supply.

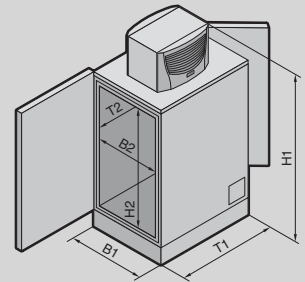

<b>U</b>	15
Cooling capacity kW	2.4
<b>Width (B1) mm</b>	806
<b>Height (H1) mm</b>	1699
<b>Depth (T1) mm</b>	1270
Clearance width (B2) mm	620
Clearance height (H2) mm	827
Clearance depth (T2) mm	1024
Weight excluding internal installation approx. kg	360
<b>Model No. LS Basic Safe with built-in 482.6 mm (19") rack</b>	<b>7999.999</b>
<b>Model No. LS Basic Safe without built-in 482.6 mm (19") rack</b>	<b>7999.898</b>
<b>Accessories</b>	
482.6 mm (19") rack, 15 U, depth 1000 mm	<b>7995.992</b>
Early fire detection system EFD Plus	see page 328
Fire alarm and extinguisher system DET-AC Plus	see page 328
CMC monitoring system	see page 577

### Standard protection from:



Fire



Extinguishing water



Vandalism



Unauthorised access



Dust



Theft/burglary



## System accessories Page 355

### Applications:

- Solid protection against potential physical threats for IT components
- Targeted configuration components transform the safe into a complete, compact data centre.

### Benefits:

- Modular assembly
- Prepared for the installation of various IT climate control solutions
- Low weight
- User-friendly, thanks to operator and service door

### Protection standards:

- Fire protection F90 based on DIN 4102
- Burglary protection WK 2 to EN 1627
- Protection against dust and water jets IP 56 to IEC 60 529
- Protection from acrid gases to DIN 18 095

### Material:

Pladur plate

### Colour:

Enclosure: RAL 7035

### Supply includes:

- Security safe as a two-door system
- Cable duct in both side elements
- Both doors with semi-cylinder and two locks
- Optional cable routing in the top element, selectable positioning

### Detailed drawings:

Available on the Internet.

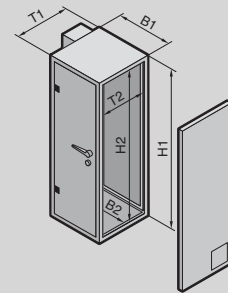

		Two-door-system	
<b>U</b>		33	47
<b>External dimensions mm</b>	Width (B1)	1500	1500
	Height (H1)	1942	2321
	Depth (T1)	1238	1238
<b>Internal dimensions mm</b>	Width (B2)	979 <sup>1)</sup>	979 <sup>1)</sup>
	Height (H2)	1840	2219
	Depth (T2)	1010	1010
<b>Clearance height of door opening mm</b>		1678	2057
<b>Model No. LS</b>		<b>7999.892</b>	<b>7999.893</b>
<b>Accessories</b>			
482.6 mm (19") rack, based on TS 8, 482.6 mm (19") level front and rear, 6 support strips for mounting on the 482.6 mm (19") level, 2 punched sections with mounting flanges	W 800 x H 1600 x D 1000	<b>7831.429</b>	–
	W 800 x H 2000 x D 1000	–	<b>7995.969</b>
	W 800 x H 2200 x D 1000	–	<b>7999.970</b>
Early fire detection system EFD Plus		see page 328	
Fire alarm and extinguisher system DET-AC Plus		see page 328	
CMC monitoring system		see page 577	
Climate control for Modular Safe		see page 325/326	

<sup>1)</sup> With built-in heat exchanger.

### Standard protection from:



Fire



Extinguishing water



Vandalism



Unauthorised access



Dust



Theft/ burglary

# Modular Safe Extend



System accessories Page 355

## Applications:

- A high level of protection against potential physical threats for IT
- Targeted configuration components transform the safe into a complete, compact data centre.

## Benefits:

- Modular assembly
- Expandability for graduated investment in line with IT growth
- Prepared for the installation of various IT climate control solutions
- Systems may be dismantled and reassembled, for maximum investment security

## Protection standards:

- Fire protection F90 based on DIN 4102
- Compliance with limit values  $\Delta T < 50$  K, relative humidity  $< 85\%$  for 30 minutes
- Burglary protection optionally WK 2, 3 or 4 EN 1627
- Protection against dust and water jets IP 56 to IEC 60 529
- Protection from acrid gases to DIN 18 095

The tests were performed as system tests and confirmed by way of test reports.

## Material:

Pladur plate

## Colour:

Enclosure: RAL 7035

## Supply includes:

- Security safe with operator door and servicing door
- Cable entry in both side elements
- Both doors with key lock

## Optional:

- Electronic combination lock
- Electronic lock pre-equipped for activation by an external access control system
- Cable entry in the top and base unit
- Twin-walled doors
- Choice of door hinges

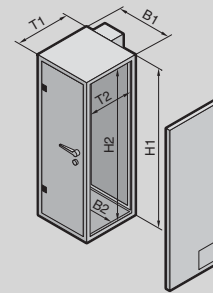

## Detailed drawings:

Available on the Internet.

U		42	47	42	47	
External dimensions mm	Width (B1)	1100	1100	1100	1100	
	Height (H1)	2210	2410	2210	2410	
	Depth (T1)	1200	1200	1400	1400	
Internal dimensions mm	Width (B2)	920	920	920	920	
	Height (H2)	2030	2230	2030	2230	
	Depth (T2)	1000	1000	1200	1200	
Model No. LS	Individual solution	<b>7999.896</b>	<b>7999.897</b>	<b>7999.983</b>	<b>7999.987</b>	
	Left	<b>7999.977</b>	<b>7999.980</b>	<b>7999.984</b>	<b>7999.988</b>	
	Suite creation Centre	<b>7999.978</b>	<b>7999.981</b>	<b>7999.985</b>	<b>7999.989</b>	
	Right	<b>7999.979</b>	<b>7999.982</b>	<b>7999.986</b>	<b>7999.990</b>	
<b>Accessories</b>						
482.6 mm (19") rack, based on TS 8, 482.6 mm (19") level front and rear, 6 support strips for mounting on the 482.6 mm (19") level, 2 punched sections with mounting flanges		W 800 x H 2000 x D 1000	<b>7995.969</b>	<b>7995.969</b>	<b>7995.969</b>	<b>7995.969</b>
		W 800 x H 2200 x D 1000	<b>7999.970</b>	<b>7999.970</b>	<b>7999.970</b>	<b>7999.970</b>
Early fire detection system EFD Plus				see page 328		
Fire alarm and extinguisher system DET-AC Plus				see page 328		
CMC monitoring system				see page 577		
PSM busbar				see page 202		
Climate control for Modular Safe				see page 325/326		

## Standard protection from:



Fire



Extinguishing water



Corrosive gases



Vandalism



Unauthorised access



Dust



Theft/burglary

# Climate control for Modular Safe/Modular Safe Extend



System accessories Page 355 Modular Safe/Modular Safe Extend Page 323/324

- All climate control units are designed as split units to ensure hermetic separation between the cooling circuits inside and outside of the safe. This prevents the ingress of dust and corrosive gases.
- Air routing inside the safe is horizontal. The hot air is drawn in at the rear, and the cooled air is expelled in front of the 482.6 mm (19") level.

## Compact climate control

Suitable for use in rooms with climate control in the building or adequate ventilation, and low or no noise level requirements. The climate control unit is available in the output categories 2.5 kW and 4 kW.

The evaporator coil is fastened to the side panel on the inside of the modular safe, and the external device on the service door (Modular Safe Extend) or side panel (Modular Safe).

## Outdoor climate control

When using the outdoor variant, the internal circuit of the climate control unit is secured to the side panel on the inside of the safe.

The external unit is positioned outside of the building. The internal and external units are connected to one another via coolant lines and control cables. The hot air from the servers is drawn in at the rear of the safe, and the cooled air is expelled in front of the 482.6 mm (19") level. Benefits of the outdoor model: The waste heat is routed directly to the outside. As a result, room ventilation or air-conditioning is not necessary.

## Outdoor climate control with inverter technology

The external unit with inverter technology allows targeted speed control of the compressor. The volume of refrigerant is regulated via the electronic expansion valve. Adaptation to cooling requirements facilitates energy savings of up to 40%. The cold air is expelled in front of the 482.6 mm (19") level by the internal unit (evaporator coil), while the hot air is drawn in at the rear. Modified air baffle plates achieve additional efficiency gains and help to avoid hot spots.

## Compact climate control

Model No. SK		3126.230	3126.240
Rated operating voltage V, Hz		400/460, 3~, 50/60	
Dimensions mm	W x H x D external unit	500 x 1580 x 231	
	W x H x D internal unit	804 x 1544 x 100	
Useful cooling output $\dot{Q}_K$ to DIN 3168	L 35 L 35	2500 W/3090 W	4000 W/4010 W
	L 35 L 50	2070 W/2300 W	3020 W/3250 W
Rated current max.		3.3 A/3.5 A	4.1 A/4.8 A
Start-up current		14.2 A/14.7 A	15.2 A/15.8 A
Pre-fuse T		6,3 – 10.0 A	
Motor circuit-breaker		■	■
Power consumption $P_{el}$ to DIN 3168	L 35 L 35	1275 W/1615 W	1620 W/2125 W
	L 35 L 50	1525 W/1920 W	1825 W/2835 W
Refrigeration factor $\epsilon = \dot{Q}_K/P_{el}$	L 35 L 35	2.0	
Refrigerant		R134a, 1500 g	R134a, 2900 g
Permissible operating pressure p. max.		28 bar	
Temperature and setting range		+20°C to +55°C	
Noise level dB (A)		< 70	< 72
Protection category to IEC 60 529	Internal circuit	IP 54	
	External circuit	IP 24	
Weight	External unit	65 kg	
	Internal unit	70 kg	
Colour		RAL 7035	
Temperature control		Comfort controller (factory setting +25°C)	

# Climate control for Modular Safe/Modular Safe Extend

## Outdoor climate control

Model No. SK	7999.963	7999.965	7999.964	7999.966
Redundancy	–	–	■	■
Rated operating voltage V, Hz	230 V, 50 Hz, 1~	400 V, 50 Hz, 3~	230 V, 50 Hz, 1~ (2 x)	400 V, 50 Hz, 3~ (2 x)
Dimensions mm	W x H x D 795 x 610 x 290	900 x 680 x 340 (2 x)	795 x 610 x 290	900 x 680 x 340 (2 x)
<b>Useful cooling output <math>\dot{Q}_K</math> to DIN 3168</b>	<b>L 25 L 35</b> <b>2400 W</b>	<b>5000 W</b>	<b>2400 W</b>	<b>5000 W</b>
Rated current per unit, max.	3.8 A	4.1 A	3.8 A	4.1 A
Start-up current per unit	19.5 A	35 A	19.5 A	35 A
Pre-fuse T	16 A	3 x 16 A	16 A (2 x)	3 x 16 A (2 x)
Refrigerant	R410 a			
Temperature and setting range	–15°C to +35°C			
Weight	External unit	38 kg	74 kg	2 x 38 kg
	Internal unit	59 kg	59 kg	63 kg
Colour	RAL 7035			
<b>Accessories</b>				
Refrigerant line incl. electric control cable for 2400 W, length 20 m	<b>7999.961</b>	<b>7999.961</b>	<b>7999.961</b>	<b>7999.961</b>
Refrigerant line incl. electric control cable for 5000 W, length 20 m	<b>7999.962</b>	<b>7999.962</b>	<b>7999.962</b>	<b>7999.962</b>

## Outdoor climate control with inverter technology

Model No. SK	7999.991	7999.992
Redundancy	–	■
Rated operating voltage V, Hz	230 V, 50 Hz, 1~	230 V, 50 Hz, 1~ (2 x)
Dimensions mm	W x H x D 900 x 795 x 320	900 x 795 x 320 (2 x)
<b>Useful cooling output <math>\dot{Q}_K</math> to DIN 3168</b>	<b>L 18<sup>1)</sup>/L 35</b> <b>L 18/L 43</b> <b>7850 W</b> <b>7030 W</b>	
Rated current max.	13.9 A	
Start-up current	36 A	
Pre-fuse T	25 A	25 A (2 x)
Refrigerant	R410a	
Temperature and setting range	–15°C to +43°C	
Noise level	48 – 49 dB (A)	
Weight	External unit	63 kg
	Internal unit	70 kg
Colour	RAL 7035	
<b>Also required</b>		
Heat exchanger (evaporator coil)	<b>3126.270</b>	<b>3126.270<sup>2)</sup></b>

<sup>1)</sup> Server inlet temperature

<sup>2)</sup> 2 heat exchangers are required.



## Rittal Czech Republic

RITTAL Czech, s.r.o.  
Ke Zdibsku 182 · 250 66 Zdiby u Prahy  
Phone: +420 234 099 000  
Fax: +420 234 099 099  
E-mail: info@rittal.cz · www.rittal.cz

# Data Centre Container DCC



## Technical specifications:

### Fire protection:

- Fire protection, internal panels: F30, optionally F90 based on DIN 4102/EN 1363, component-tested

### Duct system:

- Type: Hard duct DN200
- Dimensions of packing space: 120 x 120 mm

### Raised floor:

- Substructure type: Control room
- Number of slotted plates dependent on number of racks
- Total raised height: 300 mm

### Climate control –

#### Direct Free Cooling:

- Available with 7 and 10 kW units. Up to 3 units can be integrated.
- Targeted cooling via aisle containment

#### Power distribution:

- Infeed: Wall-mounted CEE connector, 125 A, 3-phase/N/PE, 400 V/50 Hz
- Enclosure dimensions (W x H x D): 600 x 2000 x 400 mm

### Note on standard and customised solutions:

There is a standard range of models available with 12 pre-configured data centre types. Ask for the Rittal Data Centre Container project planning form. Within just a few days, you will receive an initial quote.

#### Customised solutions:

Bayed containers, higher cooling outputs e.g. using LCP technology or more than seven racks – we would be happy to design your own individual data centre container.

### Optional:

- Up to seven 482.6 mm (19") IT racks with power supply
- UPS, with up to 15 minutes autonomy
- Fire alarm/gas extinguisher system (Novec 1230)
- Access systems, access door (keyboard, code card)
- Monitoring and management (CMC, RiZone)

#### Detailed drawings:

Available on the Internet.

Photo shows a configuration example with equipment not included in the scope of supply.

Version	R7A	R7B	R7C	R7D	R14A	R14B	R14C	R14D	R20A	R20B	R20C	R20D
Width mm	3000											
Height mm	3250											
Depth mm	6055											
Useful area	15.2 m <sup>2</sup>											
Model No.	Project planning on request											

Cooling capacity kW	7	7	7	7	14	14	14	14	20	20	20	20
Redundancy cooling	1+1	1+1	1+1	1+1	2+1	2+1	2+1	2+1	2+1	2+1	2+1	2+1
Available area mm (racks, UPS, DET-AC)	4500	4500	4500	4500	4000	4000	4000	4000	4000	4000	4000	4000
Heavy-duty raised floor	■	■	■	■	■	■	■	■	■	■	■	■
Plug-and-play power distribution	■	■	■	■	■	■	■	■	■	■	■	■
Hard ducts 2 x DN200	■	■	■	■	■	■	■	■	■	■	■	■
Security door WK 2	■	■	■	■	■	■	■	■	■	■	■	■

### Optional fittings

UPS (uninterruptible power supply)	□	■	□	■	□	■	□	■	□	■	□	■
DET-AC XL fire alarm/extinguisher system	□	□	■	■	□	□	■	■	□	□	■	■
Max. no. of racks 42 U (600 mm wide)	7	6	7	6	7	6	6	5	7	6	6	5
Max. no. of racks 42 U (800 mm wide)	5	4	5	4	5	4	4	4	5	4	4	4
Higher racks (47 U)	□	□	□	□	□	□	□	□	□	□	□	□
Rack power supply (PSM, PDM)	□	□	□	□	□	□	□	□	□	□	□	□
Monitoring package (CMC)	□	□	□	□	□	□	□	□	□	□	□	□
Security door WK 3	□	□	□	□	□	□	□	□	□	□	□	□
Additional hard ducts	□	□	□	□	□	□	□	□	□	□	□	□
Metal sun shade	□	□	□	□	□	□	□	□	□	□	□	□

■ Standard □ Option

# Fire alarm and extinguisher system DET-AC/EFD Plus



System accessories Page 355 Server enclosures Page 91

## EFD Plus

The EFD Plus system is a compact early fire detection system with active smoke extraction system.

The integral fan system continuously extracts the air from the enclosure, and passes it over two smoke detectors. The first smoke detector is extremely sensitive and triggers a pre-alarm. The second smoke detector triggers the main alarm.

## DET-AC Plus

The DET-AC Plus is a compact fire alarm and active extinguisher system with smoke extraction system, built into one height unit. The detection system is identical to that used in the EFD Plus system. Fire extinguishing with the extinguisher gas NOVEC 1230 is automatically activated when a main alarm is triggered. With the extinguisher gas supply provided, a volume of up to 3 m<sup>3</sup> can be extinguished.

## DET-AC Plus Slave

In conjunction with the DET-AC Plus slave system, up to five bayed enclosures may be extinguished. In addition to the DET-AC Plus unit, a DET-AC Plus Save unit is used for each additional enclosure and contains the extinguisher gas for one enclosure. For detection purposes, the pipework from the DET-AC Plus system is laid in all enclosures.

## Benefits:

- Early fire detection
- Automatic extinguishing
- Innovative extinguisher gas NOVEC 1230
  - Eco-friendly
  - Uncritical for IT components
- 482.6 mm (19") rack mount with just 1 U

	Fire alarm and extinguisher system DET-AC Plus	Add-on unit DET-AC Plus Slave	Early fire detection system EFD Plus
Width mm	482,6 (19") rack mount		
Height mm	44 (1 U)		
Depth mm	640	570	500
Weight kg	Approx. 15	Approx. 12	Approx. 8
Model No. DK	<b>7338.120</b>	<b>7338.320</b>	<b>7338.220</b>

Protection category	IP 20		
Ambient temperature (operation)	+10°C to +35°C		
Battery storage	-10°C to +50°C		
Operating voltage	100/240 V AC 50/60 Hz	24 V DC	100/240 V AC 50/60 Hz
Uninterruptible mains electricity operation	2 x 12 V; 2.2 A/approx. 4 h		
Connections	3 RJ 12 connectors for connecting to the CMC, alternatively 3 relay outputs, max. contact load 24 V DC/0.5 A		
Sensors	2 different scattered-light sensors	–	2 different scattered-light sensors
Display	LCD display with plain text information	–	LCD display with plain text information
No. of slave modules	Max. 4	–	Max. 5
No. of monitored enclosures	Max. 5	–	Max. 5
Extinguisher gas	NOVEC 1230	NOVEC 1230	–
Fill volume of extinguisher gas	3.2 kg	3.2 kg	–
Admissible max. protection volume	3 m <sup>3</sup>	3 m <sup>3</sup>	–

## Also required

	7338.130	7338.130	7338.130	Page
Pipe kit	<b>7338.130</b>	<b>7338.130</b>	<b>7338.130</b>	
RJ 12 cable for alarm relaying to CMC, packs of 2	7320.814 <sup>1)</sup>	7320.814 <sup>1)</sup>	7320.814 <sup>1)</sup>	585
Access sensors	7320.530	7320.530	–	583
Depth-variable slide rails	–	–	7063.883	559

<sup>1)</sup> 2 packs are required.



# Fire alarm and extinguisher system DET-AC XL



System accessories Page 355 Server enclosures Page 91

Standardised solution for extinguishing individual bayed enclosure suites with up to 24 enclosures or entire rooms. All components of the system are built into a 300 mm wide TS 8 enclosure, facilitating optimum baying to a suite of server enclosures. The integral early-warning fire detection system with active smoke extraction detects fire from a very early stage. The fire is extinguished automatically. NOVEC 1230 is used as the extinguisher gas.

#### Benefits:

- Extinguisher system for room volumes up to 84 m<sup>3</sup>
- Rack extinguisher system for up to 24 racks
- Suitable for incorporation into TS 8 server rack suites
- Simple project planning on the basis of standard packages
- Innovative extinguisher gas NOVEC 1230
  - Eco-friendly
  - Uncritical for IT components

#### Three solutions are available in the standard version:

##### For extinguishing up to:

- 8 racks
- 16 racks
- 24 racks

In addition, Rittal is able to configure both room and rack extinguisher systems to your individual specifications.

#### Function principle:

The detection system of the DET-AC XL draws room or rack air in continuously and detects even the tiniest smoke particles during the initial phase of a fire, the pyrolysis phase.

After a defined delay time, the extinguisher gas bottle is opened electrically and the gas flows out into the room or racks via the extinguisher nozzles.

Photo shows a configuration example with equipment not included in the scope of supply.



Fire alarm and extinguisher system DET-AC XL	S-08-40-10	S-16-40-10	S-24-40-10	S-08-40-12	S-16-40-12	S-24-40-12
Width mm		300			300	
Height mm		2000			2000	
Depth mm		1000			1200	
Model No. DK	7338.160	7338.161	7338.162	7338.163	7338.164	7338.165
<b>Accessories</b>						
Nozzle piping kit for extinguisher system	7338.166	7338.166	7338.166	7338.166	7338.166	7338.166
Piping kit for smoke extraction system	7338.167	7338.167	7338.167	7338.167	7338.167	7338.167
Nozzle piping kit for extinguisher system between enclosure suites	7338.168	7338.168	7338.168	7338.168	7338.168	7338.168
Piping kit for smoke extraction system between enclosure suites	7338.170	7338.170	7338.170	7338.170	7338.170	7338.170
Pressure relief valve for enclosures	7338.171	7338.171	7338.171	7338.171	7338.171	7338.171



## We plan and implement data centres

Whether you are planning a new building, an extension or an optimisation to your data centre, we are at your side as a trustworthy partner and leading provider with decades of experience.

- Basic protection or high-MBTB protection for data centres
- Extendible
- Dismantling and reassembly = investment protection
- Dust- and noise-reduced installation
- System-tested
- Multi-functional risk coverage

Criterion	Standards	Conventional design <sup>2)</sup>	Basic protection		High-MBTB
			LER Extend	LER Basic	LSR 18.6 E
<b>System testing</b>	 Testing of the following standards as complete system or structure <sup>1)</sup>	–	■	■	■
<b>Fire protection</b> Testing at temperatures of up to 1000°C and above	 ECB-S certifications to EN 1047-2, 50 K temperature increase and 85% rel. humidity up to 24 hours (reheating period), 60 minutes flame impingement time	–	–	–	■
	50 K temperature rise and 85% rel. humidity over 30 minutes, without reheat period	–	■	–	■
	F120 as system test, according to the limits of EN 1363 (DIN 4102), for the cellular structure and its built-in modules	–	–	–	■
	F90 as system test, according to the limits of EN 1363 (DIN 4102), for the cellular structure and its built-in modules	–	■	■	■
	F180 only as component testing to EN 1363 (DIN 4102), wall system only	–	–	–	■
	F120 only as component testing to EN 1363 (DIN 4102), wall system only	■	■	■	■
<b>Explosion</b>	Detonation test as system testing of 200 kg TNT from 40 m	–	–	–	■
	Standing water, 72 hours, 40 cm, maximum 20 drops	–	–	–	■
	Extinguisher water, IP x6 as system testing to IEC 60 529, for the cellular structure and its built-in modules	–	■	■	■
	Relative humidity, 85%, over 24 hours (reheat period), 60 minutes flame impingement time, to EN 1047-2	–	–	–	■
<b>Water</b>	Relative humidity, 85%, over 30 minutes	–	■	–	■
	IP 5x as system testing to IEC 60 529, for the cellular structure and its built-in modules	–	■	■	■
<b>Dust-tightness</b>	Acrid gas-tightness, based on EN 1634-3 (DIN 18 095)	–	■	■	■
<b>Corrosive fire gases</b>	WK 3 as system test to EN 1627/1630, for the cellular structure and its built-in modules, such as doors	–	■	■	■
	WK 2 as system test to EN 1627/1630, for the cellular structure and its built-in modules, such as doors	–	■	■	■
	WK 4 only as component testing to EN 1627/1630, door system only	–	–	–	■
<b>Unauthorised access</b>	Shock test as system test, 3 shocks of 200 kg from 1.5 m after 45 minutes flame impingement time	–	–	–	■
	Shock test as system test, 1 shock of 200 kg from 1.5 m after 30 minutes flame impingement time	–	■	■	■
<b>Falling debris</b>	Protection against high-frequency irradiation and radiation, verified by tests on comparable components by TU Aachen	–	■	■	■
<b>EMC protection</b>	Extended high-frequency shielding in accordance with BSI TL-03304	–	–	–	■
<b>EMC optional package</b>		–	–	–	■

<sup>1)</sup> System-tested products are tested as a complete construction. This comprises the cellular structure and installation modules such as doors, cable shields or ventilation units. By contrast, component testing only refers to individual parts.

<sup>2)</sup> The conventional design refers to room structures of plasterboard, concrete and other standard construction materials which do not offer sufficient protection for data centre applications. Conventional designs are generally tested for use as fire walls.



## Software & services

---

Expertise .....	335
Planning .....	337
Project management .....	341
Configuration .....	343
Monitoring .....	345
Service .....	349
Quality management .....	353

### Training courses, seminars and workshops

See our website [www.rittal.com](http://www.rittal.com)

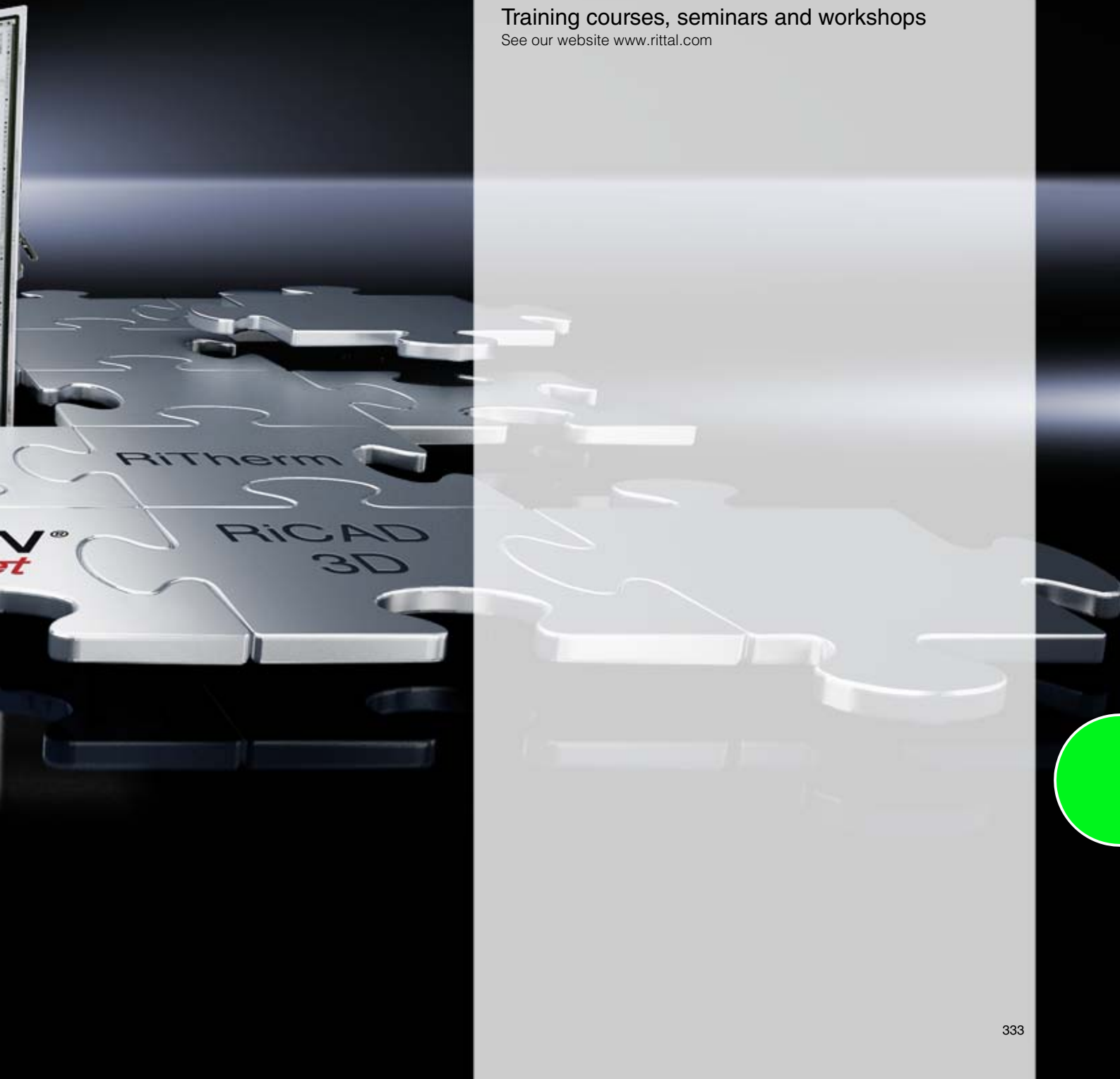

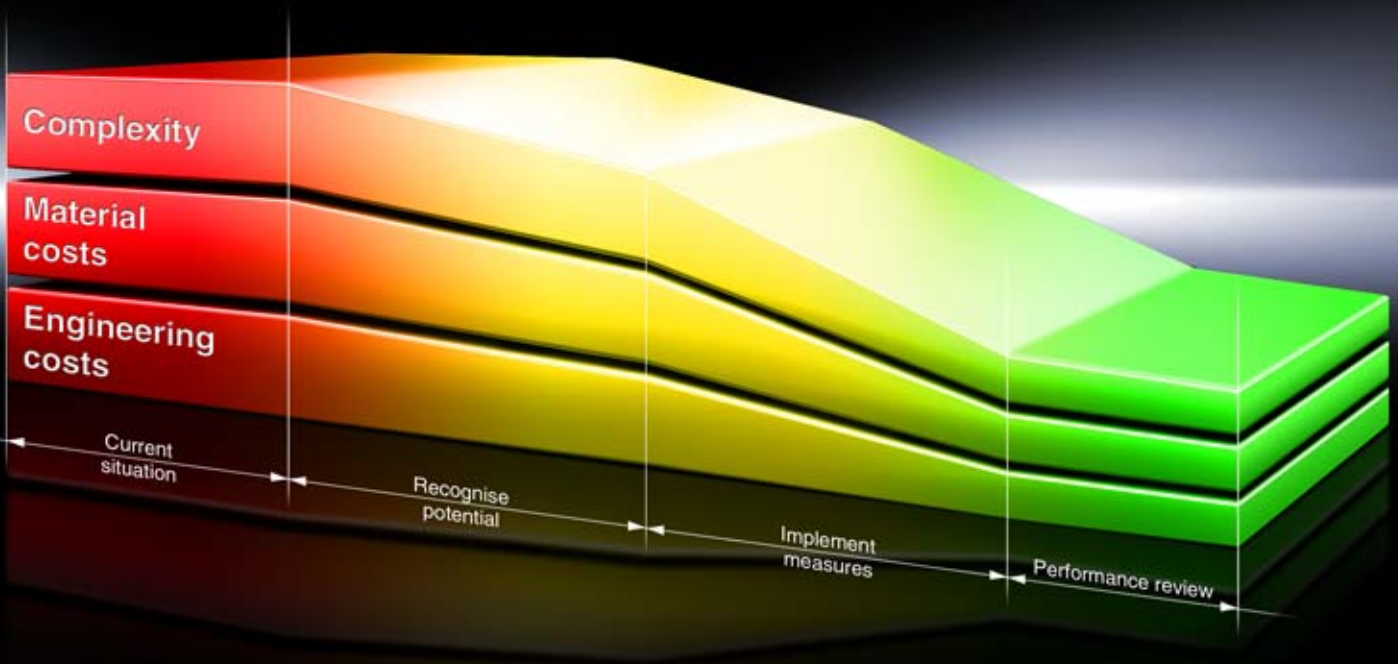

## Rittal system consulting

Rittal offers you more than just efficient products. Rittal can help you to save costs throughout the entire value creation chain. It is a question of uncovering and tapping into hidden potential. A whole team of Rittal experts – who know exactly what they are talking about – are waiting to give you their support. Together with your own specialists, they investigate the full process chain, from initial development and engineering, through to the actual manufacturing. Always on the lookout for optimisation potential.

Rittal offers you an ingenious and integrated concept combining consulting, software, products, services and support. A conclusive approach, but nevertheless open to all your individual contributions. Benefit from our proven expertise and long-standing experience. Put our promise to the test.

**Rittal has both the consultants and the requisite know-how.**



## Step 1: Analysis of current situation

Rittal follows a systematic approach to solution-finding. The starting point is a customer-specific analysis of the current situation at all levels:

- Products, tools and software used
- Defined processes and procedures
- Efficiency of the solution

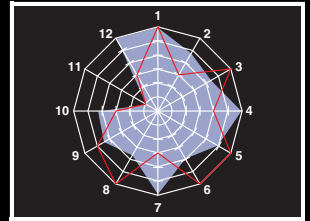

## Step 2: Identify potential

The second step is to uncover the potential for time and cost savings. An individual evaluation scrutinises data consistency, technology efficiency and the options for process optimisation. In many cases, the first savings are already apparent here.



## Step 3: Implement measures

With corresponding support from Rittal, the customer can now translate the theoretical results into concrete efficiency-boosting measures. Rittal possesses all the necessary intelligent tools, solutions and systems. Each component is perfectly integrated – without compromise, without the need for improvisation.



## Step 4: Performance review

A systematic approach is the key to significantly enhanced efficiency. To this end, Rittal offers a complete package (products, planning and software, service and support). After a defined period, we join you to review the success of the implemented measures.







## RiCAD 3D

### The download platform for seamless integration of Rittal CAD data into your plant designs – 3D data for efficient planning

Regardless of which CAD system you use, RiCAD 3D effectively supports the efficiency and productivity of your plant design work.

It includes both 2D and 3D drawings for virtually all Rittal products, together with an extensive range of system accessories.

#### Benefits:

- Precisely detailed CAD product data
- Export in all standard CAD formats
- Simple integration into the most varied CAD systems
- Considerable reduction of engineering and design work
- Error-free, detailed Rittal data
- Generic original data in 3D and 2D format
- No conversion of neutral formats

CAD data in the following formats:

- DWG.3D
- ProE 2001
- ProE Wildfire
- SolidWorks 3D
- Neutral Step format

Fast online access to original data in many other CAD formats with direct downloading facility available at: [www.rittal.com](http://www.rittal.com)

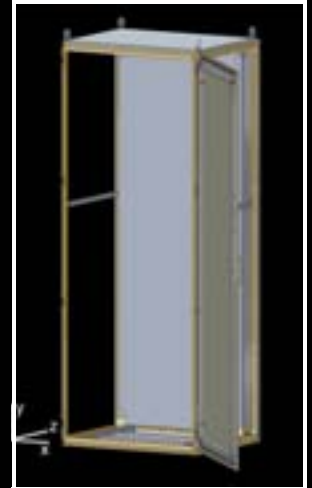
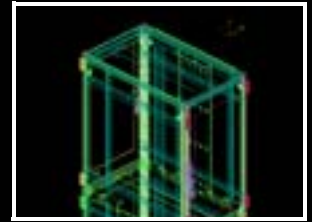

## AE Laser Express

Rittal provides a very special service: You will receive an enclosure that has been assembled as defined in your specifications, finished with cut-outs and drilled holes and painted in the special colour that you stipulated within just 7 days!

#### Benefits:

- Send us your drawing via our Internet portal. You will receive your quote within the next 24 hours.
- Production will start as soon as we receive your order.
- Within 7 days, customers in Germany will receive their own compact enclosure, custom-manufactured for their particular application.

[www.rittal.com](http://www.rittal.com)



# Planning



## EPLAN platform

- EPLAN electric P8
- EPLAN pro panel
- EPLAN fluid
- EPLAN ppe
- EPLAN cabinet
- EPLAN data portal
- EPLAN engineering center

## All applications on the same, consistent platform technology

- Uniform project planning environment for electrical, fluid, E&C engineering and 3D assembly design
- Consistent project data and component management
- Modularisation for individual system configuration
- Open system architecture for seamless system integration
- Cross-platform basic functions

[www.eplan.com](http://www.eplan.com)

The logo for ePLAN electric P8, featuring the word "ePLAN" in a stylized red and black font, with "electric P8" in a smaller red font below it.

## EPLAN electric P8

### The new dimension in engineering.

- Professional project planning, documentation and administration of electrical engineering automation projects
- Optimisation of the engineering process through standardisation, reuse and automated circuit diagram generation
- Variant technology – unique, powerful, convincing
- High-end electrical project planning – process-oriented and automated
- Transfer and processing of data from upstream processes
- Qualified master data ready to use “out-of-the-box”
- Consistent support in circuit diagram generation

The logo for ePLAN pro panel, featuring the word "ePLAN" in a stylized red and black font, with "pro panel" in a smaller red font below it.

## EPLAN pro panel

- High-end 3D assembly layouts for electrical and fluid design
- Description of the assembly layout with virtual 3D prototypes
- EPLAN eTouch technology for the simplest handling
- Positioning aids for optimum dimensioning and utilisation of the available space
- Planning confidence by taking manufacturer data into account
- 50% or more time savings with layout
- Early availability of precise production documents
- Precise-fit components for greater assembly efficiency
- Complete consistency with participating engineering disciplines
- Improved communications thanks to high-quality documentation

The logo for ePLAN fluid, featuring the word "ePLAN" in a stylized red and black font, with "fluid" in a smaller red font below it.

## EPLAN fluid

### From drawing to engineering.

- Clear project structures instead of a single drawing
- The latest symbol data based on the current standard ISO 1219
- Consistency in electro-hydraulic system documentation
- Direct connection of parts lists and hydraulic diagrams
- Automatic documentation of revisions

## EPLAN ppe

### For consistent engineering with process technology in mechanical and plant engineering

- Professional planning and project management of EI&C technology in process-related machinery and plant
- Generation of plant overviews, P&I diagrams, administration of PIC points, and documentation
- Smooth-running interdisciplinary cooperation thanks to deep platform integration
- Optimum support for both preplanning and detailed planning



**ePLAN**<sup>®</sup>  
*ppe*

## EPLAN cabinet

### Efficient enclosure production in the product development process

- Transfer of equipment and wiring information from the upstream electrical design
- 3D configuration of mounting plates and enclosures
- Automatic calculation of optimum wiring routes and wire lengths
- Transfer of production data to NC machines
- Transfer of assembly data to wire assembly machines
- High-quality product data thanks to links with RiCAD 3D



**ePLAN**<sup>®</sup>  
*cabinet*

## EPLAN data portal

### Web-based supply of high-quality equipment data.

- Seamless integration into the EPLAN platform
- Fast project planning with no media interruptions
- Minimal effort required for master data maintenance
- Enhanced quality, thanks to high-quality templates
- Extensive additional information
- Multi-lingualism at no extra cost
- Uniform layout and complete documentation



**ePLAN**<sup>®</sup>  
*data portal*

## EPLAN engineering center

### Functional engineering for unimaginable productivity benefits.

- Functional engineering is the crucial link between sales, design and service
- Existing projects indicate potential savings of up to 80%
- EPLAN EC guarantees rapid commissioning on the basis of tested, standardised machine functions
- Cross-disciplinary engineering minimises the need for coordination and speeds up the time to market
- EPLAN EC proves that: module-based engineering cuts costs and permanently improves quality
- The EPLAN EC automatism prevents the usual last minute changes from becoming a project cost trap
- A central database ensures engineering expertise and allows rapid induction during peak project times



**ePLAN**<sup>®</sup>  
*engineering center*



## Therm 6.1 software

The Therm 6.1 software package takes care of the complex calculation of climate control requirements. A user-friendly interface guides the operator to the most suitable, correctly dimensioned climate control component.

All evaluations are closely based on the requirements of IEC/TR 60 890 AMD 1/02.95 and DIN 3168 for enclosure cooling units.

### Rittal Therm 6.1 is a calculation program for enclosure climate control.

- Improved user guidance via tabs and simple selection menus
- Express and expert versions
- Configurator for recooling systems
- Heat loss calculator for busbars
- Key calculation data is visible at all times
- Internet updates
- Fast and thorough determination of the required climate control measures
- Determining the correct climate control measures leads to cost savings
- Easy calculation of the required actual cooling output, as well as any upgrades or enhancements to the switchgear
- Detailed documentation is supplied with the calculation

Packs of	Model No. SK
1	3121.000

### Supply includes:

CD-ROM, with 19 languages

### Note:

Your free 30-day trial version may be downloaded at [www.rittal.com](http://www.rittal.com)



## Rittal Power Engineering

### Planning software for RiLine60 busbar systems and Ri4Power low-voltage switchgear with design certificate

The multi-lingual software package includes the following functions:

- Project handling, from the initial enquiry through to ordering
- Configuration of RiLine60 busbar systems in the Top enclosure system TS 8. Compact enclosures AE, CM, KS and free-standing enclosure ES 5000.
- Configuration of low-voltage switchgear with Ri4Power systems Form 1-4 and ISV
- Complete, automatic function for the generation of bills of materials and a calculation program for quote preparation
- Input and evaluation of assembly times to calculate man hours
- Access to the entire range of Rittal products
- Output of automatically generated plant documentation with rated current and heat loss calculation

Packs of	Model No. SV
1	3020.500

- Generation of special fields configured by the customer with graphical processing in the CAD view
- Import/export interfaces for product and CAD data
- Export function for order lists and bills of materials in Excel format
- Interface to EPLAN Electric P8, for the export of CAD data and bills of materials
- The extra benefit for engineering and planning offices: Output of detailed tender texts based on plants that have been project-planned in Power Engineering in MS Word format.
- Output of project-specific assembly plans together with field and plant definitions
- Integral configurator for the generation of drawings and bills of materials to create connector kits for connecting open air circuit-breakers (ACB).

### Supply includes:

CD-ROM

Languages: German/English/French/Dutch/Danish/Swedish/Czech/Italian/Spanish/Polish/Russian



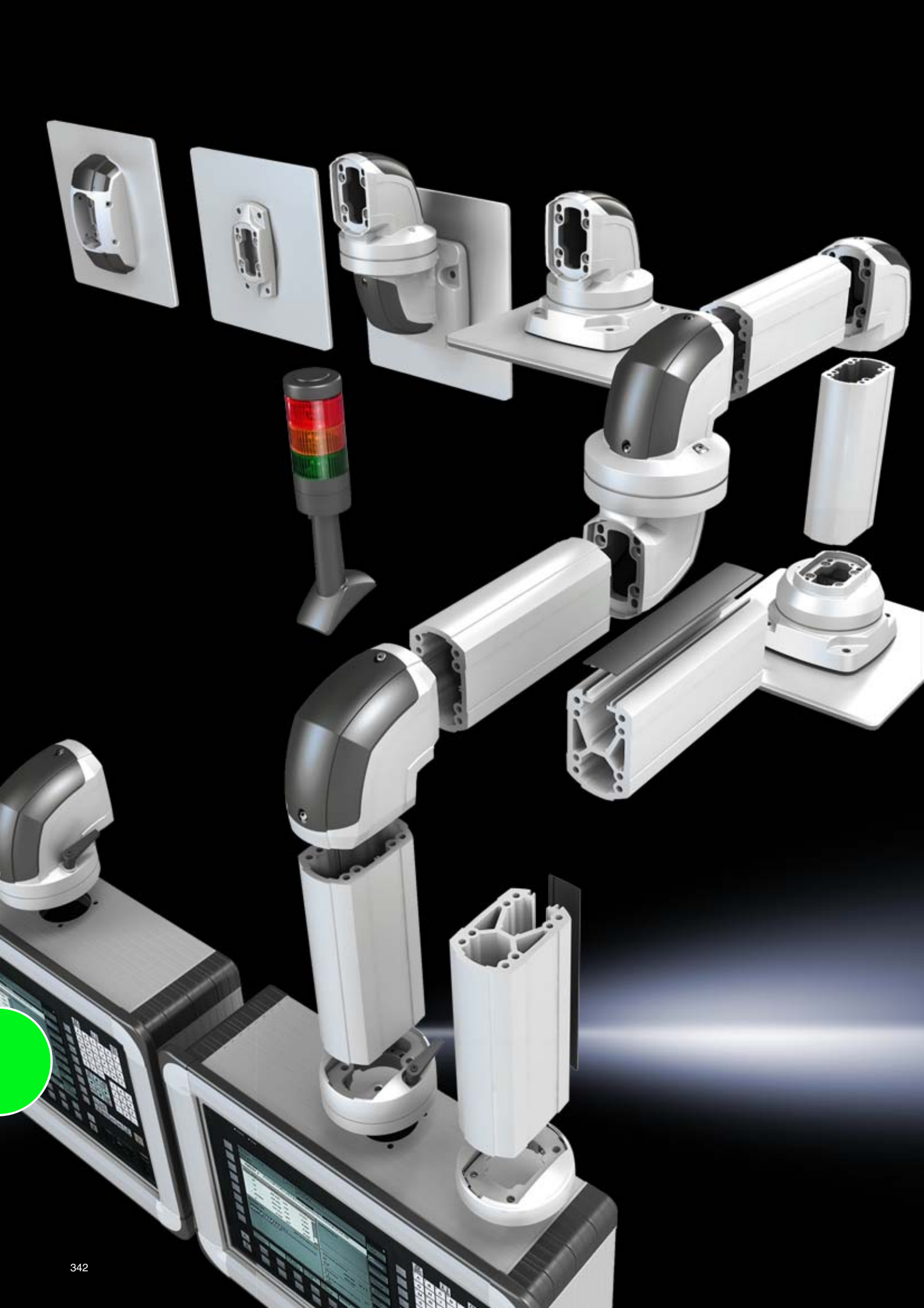

## TS 8 configurator

A complete enclosure configured in just eight clicks, including parts list and 3D model.

### Benefits:

- Easy menu-assisted configuration of a bayed TS 8 enclosure with base/plinth, side panels and the handle system required
- Mounting rails and punched sections with mounting flanges can be pre-assembled for interior installation
- This will produce a 3D drawing that can be incorporated directly into the system design or integrated into EPLAN Cabinet

[www.rittal.com](http://www.rittal.com)



## Command panel configurator

Optimised, coordinated solutions for the human/machine interface based on Rittal Comfort Panel and Optipanel.

### Benefits:

- Select the enclosure that holds the panels to be used (the integrated database contains a variety of commercial panels from various manufacturers)
- Easy navigation thanks to the list of related questions
- Quick compilation of the features required
- Request a quote based on the selected data
- Request the 3D data for integration in the system design

[www.rittal.com](http://www.rittal.com)



## Support arm configurator

The system is able to precisely define the correct support arm system using important user-specific parameters such as the jib length, enclosure weight or required cable cross-section.

### Benefits:

- Individual assembly tailored to the user's specific requirements
- Integrated consistency checking
- Configured system parts list

[www.rittal.com](http://www.rittal.com)



## CM configurator

Rittal CM compact system enclosures combine the advantages of the AE compact system enclosure with the configuration diversity of the TS 8 top enclosure system.

### Benefits:

- Simple menu-assisted selection of a CM enclosure together with a base/plinth and gland plates that meet the requirements
- The relevant interior installation accessories can also be selected to match the chosen enclosure
- The end result will enable you to request a quote that reflects the actual configuration selected

[www.rittal.com](http://www.rittal.com)



## Subrack configurator

Generate a component-based order list for a subrack in just a few clicks.

### Benefits:

- Fast, reliable selection of individually coordinated systems in the Ripac Easy and Ripac Vario series
- Simple prompt masks reliably create technically feasible solutions with error-free order lists
- Intelligent plausibility checking of admissible component combinations
- Request a quote based on the order list generated
- Parts list for the configured subrack

[www.rittal.com](http://www.rittal.com)



## IT configurator

Rittal offers the ideal system solution for every networking task, matched to the user's individual demands.

### Benefits:

- A specific enclosure can be selected
- Accessories can be configured
- Plausibility checking
- The end result will enable you to request a quote that reflects the actual configuration selected

[www.rittal.com](http://www.rittal.com)







## RiZone Appliance Standard

RiZone is supplied as an appliance or a software appliance.

As an appliance, RiZone is supplied with global support, installed on a powerful server. The software appliance is available as a virtual server which can easily be used on existing hardware in the data centre.



### Also required:

RiZone Appliance IP node licence according to the number of IP nodes available

Standard version	Model No. DK		
	Hardware appliance <sup>1)</sup>	Server with Windows	RiZone software
<b>7990.101</b>		<b>7990.201</b>	<b>7990.301</b>
Software appliance <sup>1)</sup>	Hard drive + Windows	RiZone software	RiZone graphics tool
	<b>7990.103</b>	<b>7990.203</b>	<b>7990.303</b>

<sup>1)</sup> All Model Nos. on the same line belong together, and must always be ordered together.

## RiZone Appliance IP node licence

The flexible RiZone licence model allows optimum adaptation to any project size, while at the same time allowing the opportunity to grow with the data centre.

The volume licences for the IP nodes are graduated from 10 to 1000 nodes and may be adapted precisely to the size of the data centre. For each active component or other SNMP-compatible component to be covered, one node licence is required.

For no. of IP nodes <sup>1)</sup>	Console licences included	Model No. DK	
		RiZone software	RiZone graphics tool
10	2	<b>7990.205</b>	<b>7990.305</b>
25	4	<b>7990.206</b>	<b>7990.306</b>
50	4	<b>7990.207</b>	<b>7990.307</b>
100	8	<b>7990.208</b>	<b>7990.308</b>
250	10	<b>7990.209</b>	<b>7990.309</b>
500	15	<b>7990.210</b>	<b>7990.310</b>
1000	20	<b>7990.211</b>	<b>7990.311</b>

<sup>1)</sup> All Model Nos. on the same line belong together, and must always be ordered together.



# Monitoring

## Client Access licence

Additional licence for operation of another RiZone console.

	Model No. DK	
	RiZone software	RiZone graphics tool
Client Access <sup>1)</sup>	<b>7990.213</b>	<b>7990.313</b>

<sup>1)</sup> All Model Nos. on the same line belong together, and must always be ordered together.

## RiZone module SNMP support for units from other manufacturers

For the incorporation of SNMP-compatible units from other manufacturers into RiZone. With MIB browser.

Extension	Model No. DK
RiZone SNMP support for units from other manufacturers	<b>7990.014</b>

## Microsoft Operations Manager Management Pack

For integrating RiZone into the Microsoft Operations Manager.

Extension	Model No. DK
Microsoft SCOM Management Pack	<b>7990.012</b>





## RCCMD software

Client software to control the server shutdown via the PMC UPS. The software supports all common operating systems and versions (e.g. Windows 7, VISTA, XP, Server 2003/2008, UNIX/LINUX and VMWARE Sphere/ESX Server, CITRIX XEN etc). One licence is required for each server to be shut down on an event-controlled basis.

Licences	Model No. DK
Single licence	<b>7857.421</b>
Licence bundle (5 servers)	<b>7857.423</b>
Licence bundle (25 servers)	<b>7857.424</b>

**Note:**

Software updates and a complete list of currently supported operating systems may be found at [www.rittal.com](http://www.rittal.com).

## RiDiag II

For the diagnosis, maintenance and long-term data capture of TopTherm units with Comfort controller. RiDiag logs equipment data and prepares an error list. RiDiag also offers the option of displaying and setting the device's operating parameters. The logging of measurement data can be tracked in real time in the form of a diagram.

**Supply includes:**

- CD-ROM
- Languages: German/English/Italian/French/Spanish/Portuguese
- Connection cable

Packs of	Model No. SK
1	<b>3159.100</b>





# Service – Global availability

## Rittal Global Service: Always on hand, whenever you need us!

Perfect service for individual requirements, all from a single supplier. That's Rittal Global Service. Wherever in the world you use our products, we are happy to ensure that every aspect of "Rittal – The System." is exactly as it should be. With this in mind, every minute and every kilometre counts when it comes to service. We have set up five strategic service hubs to ensure proximity to our customers: In Germany, the USA, Brazil, China and India. Every hub forms the central heart of our regional service organisations and ensures rapid response times (on-site service engineers) and efficient service handling.

### Faster

- Short paths, fast communications: Thanks to regional service support points
- A perfect interplay between sales, project management and service

### Better

- Individual service solutions from a single source
- A high standard of qualifications among Rittal service technicians worldwide
- A uniform global service ticket system

### Worldwide

- 5 strategic service support points
- Service representation in more than 60 subsidiaries
- More than 250 service partners and over 1000 service technicians



## Around the globe, we can be contacted 365 days a year on the following numbers:

### Rittal Europe (Herborn)

✉ [service@rittal.de](mailto:service@rittal.de)  
☎ +49(0)2772 505 1855

### Rittal Asia-Pacific (Shanghai)

✉ [service@rittal.cn](mailto:service@rittal.cn)  
☎ +86 800 820 0866

### Rittal North America (Urbana)

✉ [service@rittal.us](mailto:service@rittal.us)  
☎ +1 (800) 477 4000 Option 3

### Rittal Middle East (Bangalore)

✉ [service@rittal-india.com](mailto:service@rittal-india.com)  
☎ +91 80 22 890 78

### Rittal South America (São Paulo)

✉ [service@rittal.com.br](mailto:service@rittal.com.br)  
☎ +55 11 36 22 23 77

## Service from a single partner

- 24/7/365 service availability
- Highly qualified service specialists
- Service engineers on site within 8 hours
- Automated incident and emergency management
- Individual availability of spare parts
- Global service ticket system



## Individual service throughout the entire product lifecycle

Rittal's added value begins with the perfect quality of our products, and extends throughout every phase, from planning and commissioning, right through to support and servicing once the system is up and running.

The added extra for customers with the Rittal system: Firstly, our comprehensive global service network, which complements the high quality and reliability of our products. And secondly, an extended guarantee above and beyond the statutory warranty for defects, thereby ensuring maximum availability during operation.

We have developed a range of individual service offerings for our customers, so that every potential requirement profile is covered.

In this way, we permanently ensure the systems' productivity on behalf of our customers. Services play a decisive role in our lifecycle management approach. You decide for yourself which service you need.



## We are committed to perfection at every phase

### PRE-SALES

- Advice/information
- Requirement analysis (on site)
- Load tests
- Simulation and calculation
- Thermal imaging
- Laboratory testing in our own accredited laboratories
- Project meeting
- Prototyping
- Planning/team-building (sales, service, project management, quality assurance, customer)

### IMPLEMENTATION

- Installation/integration
- Assembly and system connection
- Commissioning/parameterisation
- Final inspection and handover
- Instruction (training)
- Site coordination/project management
- Certification

### AFTER-SALES

- Service contracts
- Training
- Inspection, maintenance/servicing, repair
- Management/sale of spare parts
- Round-the-clock availability
- Thermal analyses

## Flexible service contracts: The right solution to suit every requirement.

Rittal Global Service is just as flexible and individual as your requirements. An overview of the features of the various Rittal service packages:

	Availability	Response time	Spare parts availability	Repair	Warranty extension
<b>BASIC</b>	Business hours	Next working day	Standard	1 x per annum	Optional
<b>COMFORT</b>	Business hours	Next day	Standard	2 x per annum	Optional
<b>ADVANCED</b>	24 hours 365 days a year	Next day	24 hours	2 x per annum	Yes
<b>FULL</b>	24 hours 365 days a year	8 hours	Individual concept	Individual (at least 2 x/annum)	Yes
<b>CUSTOMIZED</b>	Individual by arrangement				

## Warranty extension

Rittal products are always an excellent choice. Day after day, around the globe, they prove their high quality and reliability in tough industrial production environments. With regular preventive maintenance, you can help to further extend the product's service life and the cost-effectiveness of your plant. Anyone purchasing an "Advanced" or "Full" contract will be rewarded with a 1 to 3-year warranty extension, up to a maximum of 5 years. With "Basic", "Comfort" and "Customized" contracts, warranty extensions are optional.





# Quality management

## Quality management is a must. Quality philosophy is an attitude.

**“Rittal – The System.” stands for consistent quality management and on-going refinements to products, services and internal processes.**

Rittal quality management ensures that regulations and standards are observed, and individual customer requirements are met. In addition to this, we also define our exacting product quality demands in supplementary Rittal standards. The consistent Rittal quality philosophy guarantees perpetually high standards and ensures the global usability of all products with countless international approvals and licences.

**Alongside product quality, we also focus on process and service quality.**

All internal processes are continuously refined by quality control groups, and reviewed during in-house audits. Each year, our improvements and high standards are verified by countless successful external system and customer audits.

### Rittal offers support from day one

- Project planning of technical specifications
- Prototype assembly, testing and simulations
- Manufacturing and assembly
- Warehousing service and on-time delivery
- Your own personal point of contact throughout the entire project

### Accredited Rittal test laboratory in Germany

- Simulation of climatic conditions
- Dynamic and static load tests
- 3D measurement
- Particle density testing
- Hosed water tests
- Salt spray tests
- Electrical safety and function tests
- Performance testing of all active products
- Various material tests





# System accessories

## Enclosures

Base .....	358
Walls .....	385
Baying system .....	394
Doors/locks .....	402
Roof/wall mounting .....	431
Interior installation .....	443
Voltage supply .....	505
Cable management .....	511
482.6 mm (19") installation system .....	543

## Monitoring

CMC III Processing Unit/Compact .....	578
CMC III sensors .....	583
CMC III accessories .....	584
Door Control System .....	588
Monitor/keyboard unit .....	590
KVM switches .....	591
Dynamic Rack Control .....	597

## Human/machine interface

Handles .....	600
External mounting accessories .....	602
Front assembly .....	604
Monitors .....	606
Keyboards, supports and drawers .....	608
Interfaces .....	616
Signal pillars .....	618



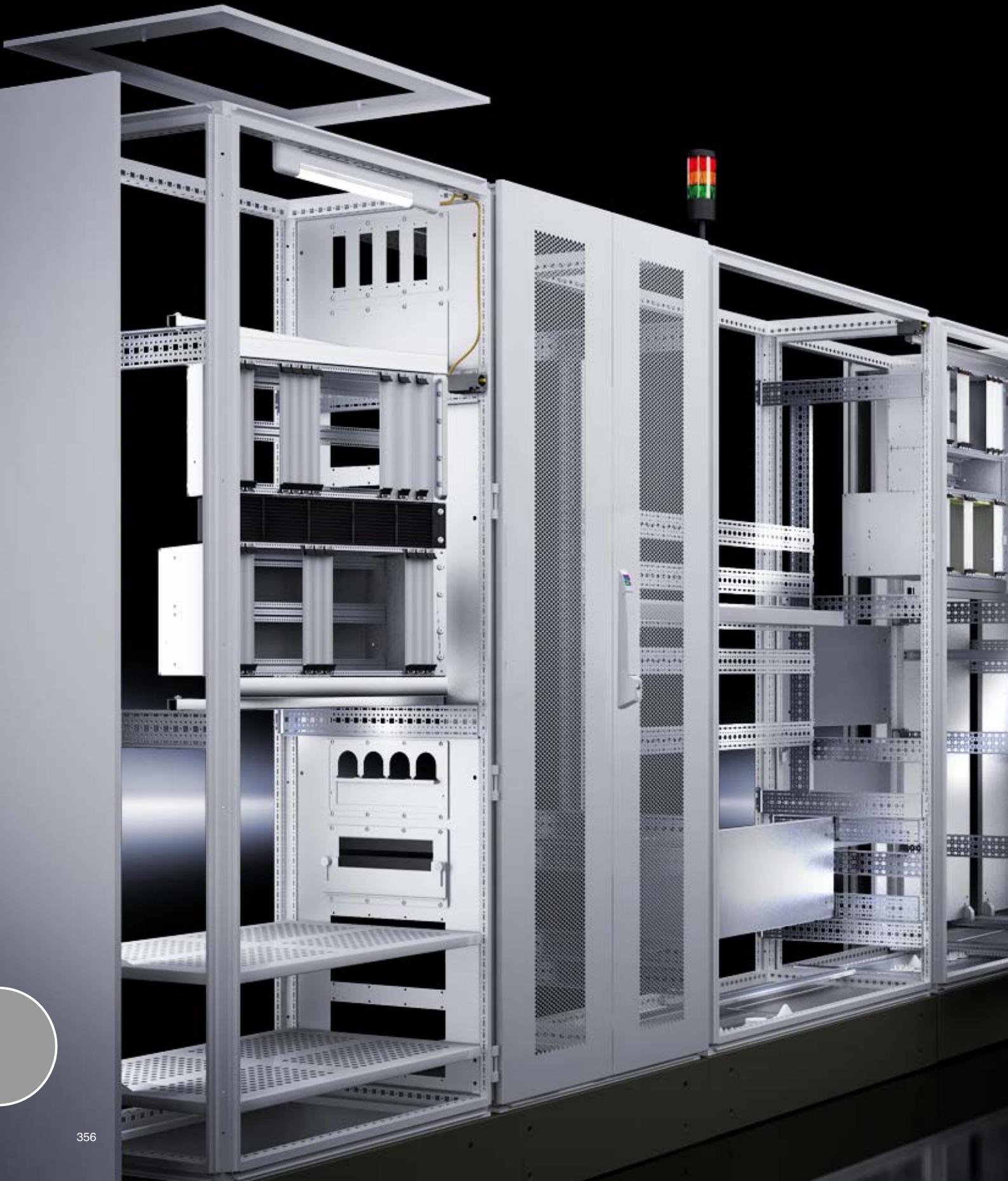

# System accessories for enclosures

## Base

Flex-Block base/plinth .....	358
TS base/plinth .....	360
Base/plinths .....	368
Base .....	373

## Walls

Side panels .....	385
Divider panels/partitions .....	389
Isolator door locking .....	393

## Baying system

Enclosure suites .....	394
TS 8 corner enclosures .....	401

## Doors/locks

Door variants .....	402
Viewing panels/operating panels .....	407
Lock systems .....	411
Hinges .....	425
Door, internal .....	426

## Roof/wall mounting

Roof .....	431
Wall mounting bracket .....	439

## Interior installation

Mounting plates .....	443
Rail systems .....	452
Assembly components .....	471
Component shelves .....	480
System lights .....	491
EMC .....	498
Earthing .....	501
Socket strips .....	505

## Cable management

Cable entry .....	511
Gland plates .....	514
Cable glands .....	519
Cable management .....	525
482.6 mm (19") cable routing .....	537

## 482.6 mm (19") installation system

Swing frame .....	543
Mounting angles .....	549
Mounting kits for mounting angles .....	555
Accessories for Data Rack .....	558
Slide rails .....	559
482.6 mm (19") installation .....	562
Patch panels .....	569
Splicing boxes .....	572
LSA connection system .....	574



# Base

## Flex-Block base/plinth system



### Flex-Block

#### for TS

- For fast, toolless assembly
- Individual cable management
- Fully symmetrical base/plinth
- Base/plinth height: 100 mm

#### Solid, RAL 9005

For enclosure size mm		Packs of	Model No. SO
400	500	1	8001.450
400	600	1	8001.460
600	500	1	8001.650
600	600	1	8001.660
600	800	1	8001.680
800	400	1	8001.840
800	500	1	8001.850
800	800	1	8001.880
800	1000	1	8001.800
1000	400	1	8001.040
1000	500	1	8001.050
1000	600	1	8001.060
1200	400	1	8001.240
1200	500	1	8001.250
1200	600	1	8001.260
1200	800	1	8001.280
1600	400	1	8001.940
1800	500	1	8001.950

We reserve the right to make technical modifications.  
Delivery times available on request.

#### Solid, RAL 7035

For enclosure size mm		Packs of	Model No. SO
600	600	1	8001.665
600	800	1	8001.685
600	1000	1	8001.605
600	1200	1	8001.625
800	800	1	8001.885
800	1000	1	8001.805
800	1200	1	8001.825

We reserve the right to make technical modifications.  
Delivery times available on request.

#### Vented in enclosure width, RAL 7035

For enclosure size mm		Packs of	Model No. SO
Width mm	Depth mm		
600	600	1	8001.661
600	800	1	8001.681
600	1000	1	8001.601
600	1200	1	8001.621
800	600	1	8001.861
800	800	1	8001.881
800	1000	1	8001.801
800	1200	1	8001.821

We reserve the right to make technical modifications.  
Delivery times available on request.

## Flex-Block base/plinth system

### Baying clip

#### for baying the Flex-Block corner pieces

Simply insert the clip from behind into the recesses provided (no need for tools).

#### Material:

Fibreglass-reinforced polyamide

Packs of	Model No. SO
12	<b>8000.100</b>

We reserve the right to make technical modifications.  
Delivery times available on request.



### Adaptor sleeve

#### for levelling feet and twin castors

To hold levelling feet and twin castors on the Flex-Block

Packs of	Model No. SO
12	<b>8000.500</b>

We reserve the right to make technical modifications.  
Delivery times available on request.



# Base

## TS base/plinth

### Modular base/plinth diversity

Regardless of the enclosure depth: The base/plinth components at the front and rear, pre-configured with corner pieces, are always the same for the chosen width. Only the side trim panels are selected according to the enclosure depth and the required base/plinth configuration. The modular concept produces exceptional advantages in terms of cost and function.

Mounting on the enclosure is conveniently carried out from the outside. The base/plinth interior offers diverse opportunities for mounting levels for cable management.

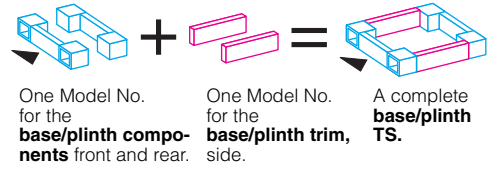

Base/pl. height	Basic form	Cable gland options				Stabilisation of bayed base/plinth
100 mm						
200 mm						

### Function and cost benefits

Fewer parts, more opportunities, lower purchasing, storage and assembly costs – this is the formula behind the new modular base/plinth system.

The following table shows three bayed base/plinths in 200 mm height illustrating a wide range of possible solutions and the potential savings with trim panels compared with the previous 200 mm base/plinth system each with two trim panels of 100 mm height at the sides.

New supply includes	Functional benefits	Savings potential compared with twelve 100 mm trim panels
3 packs of base/plinth components 1 pack of base/plinth trim panels 200 mm high	Continuous cable chamber	2 trim panels 200 mm
3 packs of base/plinth components 1 pack of base/plinth trim panels 200 mm high 1 pack of base/plinth trim panels 100 mm high 1 pack of base/plinth baying brackets TS 8601.100 (packs of 20) 4 are required for this solution.	Additional stabilisation for transportation purposes with base/plinth trim rotated through 90°	2 trim panels 200 mm 2 trim panels 100 mm
3 packs of base/plinth components 2 packs of base/plinth trim panels 200 mm high	Shielding of the base/plinths in relation to one another	4 trim panels 200 mm
3 packs of base/plinth components 1 pack of base/plinth trim panels 200 mm high 1 pack of base/plinth trim panels 100 mm high	Additional connection of the base/plinths	2 trim panels 200 mm 2 trim panels 100 mm

Other options:

- Cable entry at the side by mounting a 100 mm base/plinth trim panel (top or bottom).
- Cable entry from the rear by dismantling one or more trim panels of the base/plinth components.
- Cable clamp rail fitted on the 100 mm high trim panel.

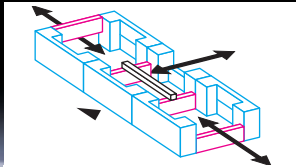
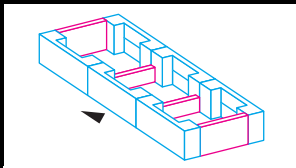
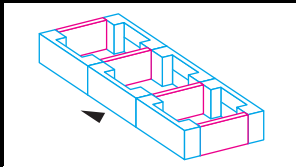
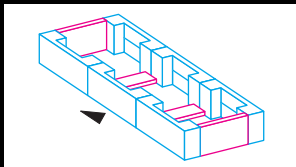
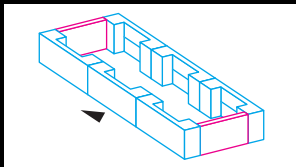



### Base/plinth components front and rear

#### Sheet steel for TS, CM, TP, PC, IW, TE

Base/plinth component consisting of one trim panel and two pre-configured corner pieces. In 200 mm high base/plinth components, one trim panel is divided into two for cable entry.

#### Material:

- Base/plinth components: Sheet steel
- Cover caps: Plastic

#### Surface finish:

Spray-finished

#### Colour:

Cover caps: RAL 9005/7035

#### Supply includes:

- 1 set =
- 2 base/plinth components, 4 cover caps,
- 4 screws and captive nuts M12 for mounting on the enclosure.



#### Accessories:

- Base mounting plate SO 2817.000, see page 364.
- Filter mat for vented versions, see page 366.

#### Detailed drawings:

Available on the Internet.

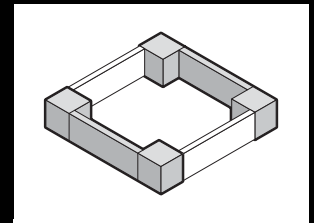
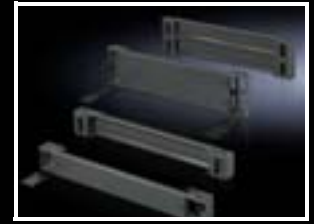

#### 100 mm high, colour: RAL 7022

For enclosure width mm	Design	Model No. TS
300	Solid	<b>8601.915</b>
400	Solid	<b>8601.400</b>
500	Solid	<b>8601.500</b>
600	Solid	<b>8601.600</b>
800	Solid	<b>8601.800</b>
850	Solid	<b>8601.850</b>
1000	Solid	<b>8601.000</b>
1100	Solid	<b>8601.300</b>
1200	Solid	<b>8601.200</b>
1600	Solid	<b>8601.920</b>
1800	Solid	<b>8601.980</b>

#### 200 mm high, colour: RAL 7022

For enclosure width mm	Design	Model No. TS
300	Solid	<b>8602.915</b>
400	Solid	<b>8602.400</b>
500	Solid	<b>8602.500</b>
600	Solid	<b>8602.600</b>
800	Solid	<b>8602.800</b>
850	Solid	<b>8602.850</b>
1000	Solid	<b>8602.000</b>
1100	Solid	<b>8602.100</b>
1200	Solid	<b>8602.200</b>
1600	Solid	<b>8602.920</b>
1800	Solid	<b>8602.980</b>

#### 100 mm high, colour: RAL 7035

For enclosure width mm	Design	Model No. TS
300	Solid	<b>8601.905</b>
600	Solid	<b>8601.605</b>
	Vented	<b>7825.601</b>
	Vented with designer cover	<b>7825.603</b>
800	Solid	<b>8601.805</b>
	Vented	<b>7825.801</b>
	Vented with designer cover	<b>7825.803</b>

#### 200 mm high, colour: RAL 7035

For enclosure width mm	Design	Model No. TS
300	Solid	<b>8602.905</b>
600	Solid	<b>8602.605</b>
800	Solid	<b>8602.805</b>

#### 100 mm high, colour: RAL 9005

For enclosure width mm	Design	Model No. TS
600	Solid	<b>8601.602</b>
	Vented with designer cover	<b>7825.605</b>
	Solid	<b>8601.802</b>
800	Vented with designer cover	<b>7825.805</b>

# Base

## TS base/plinth

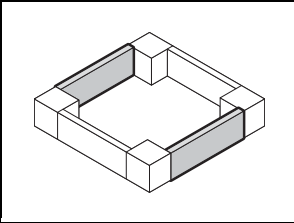

### Base/plinth trim panels, side

**Sheet steel**  
for TS, CM, TP, PC, IW, TE

For mounting between the base/plinth components. At 200 mm height, two 100 mm base/plinth trims may be used. Base/plinth trim (100 mm high) may be installed rotated through 90° in order to stabilise bayed base/plinth components.

**Material:**  
Sheet steel

**Surface finish:**  
Spray-finished

**Supply includes:**  
1 set =  
2 base/plinth trim panels, including parts for attaching to the base/plinth components.

**!** **Also required:**

Base/plinth baying brackets TS 8601.100, see page 362, when mounting base/plinth trim panels rotated through 90°.

**+** **Accessories:**

Fastening bolts for base/plinth, see page 364.

**Detailed drawings:**  
Available on the Internet.

#### 100 mm high, colour: RAL 7022

For enclosure depth mm	Model No. TS
300	8601.030
400	8601.040
500	8601.050
600	8601.060
800	8601.080

#### 200 mm high, colour: RAL 7022

For enclosure depth mm	Model No. TS
300	8602.030
400	8602.040
500	8602.050
600	8602.060
800	8602.080

#### 100 mm high, colour: RAL 7035

For enclosure depth mm	Model No. TS
600	8601.065
800	8601.085
1000	8601.015
1200	8601.025

#### 200 mm high, colour: RAL 7035

For enclosure depth mm	Model No. TS
600	8602.065
800	8602.085
1000	8602.015
1200	8602.025

#### 100 mm high, colour: RAL 9005

For enclosure depth mm	Model No. TS
800	8601.086
1000	8601.010
1200	8601.026



### Base/plinth baying brackets

for TS base/plinth

Essential if the trim panels are mounted rotated through 90° for additional stabilisation during the transportation of bayed enclosures. Additionally required for each trim panel: 2 units.

**Material:**  
Sheet steel

**Surface finish:**  
Zinc-plated

**Supply includes:**  
Screws M8 x 16 mm.

Packs of	Model No. TS
20	8601.100

## TS base/plinth

### Cable chamber

#### for TS

With integral system punchings for individual system accessories. Height = 200 mm.

#### Material:

Sheet steel

#### Colour:

RAL 7035

#### Supply includes:

- Sheet steel trim panels front and rear
- Assembly parts for mounting on the enclosure.

For enclosures		Model No. TS
Width mm	Depth mm	
400	500	<b>8600.455</b>
400	600	<b>8600.465</b>
600	500	<b>8600.655</b>
600	600	<b>8600.665</b>
800	500	<b>8600.855</b>
800	600	<b>8600.865</b>
1200	500	<b>8600.255</b>
1200	600	<b>8600.265</b>



#### Accessories:

Side panels for cable chamber, see page 363.

#### Detailed drawings:

Available on the Internet.

### Side panels

#### for cable chamber

#### Material:

Sheet steel

#### Colour:

RAL 7035

#### Supply includes:

Assembly parts.

For enclosure depth mm	Packs of	Model No. TS
500	2	<b>8600.510</b>
600	2	<b>8600.520</b>



### Transport castors

#### for TS base/plinth

For locating onto the base/plinth corner piece 100 or 200 mm high.

#### Load capacity:

Maximum permissible load per twin castor:  
Static: 100 kg

#### Supply includes:

- 1 set =
- 4 twin castors,
- 2 x with, 2 x without locks.

#### Colour:

RAL 7022

Floor clearance mm	Model No. TS
100	<b>8800.390</b>



#### Also required:

Base/plinth trim panels, side, see page 362.



# Base

## TS base/plinth



### Base mounting plate

- for
- TS base/plinth
  - base/plinth, complete

For fastening the base/plinth to the floor without moving the enclosure or the bayed enclosure suite. For assembly screws up to 12 mm Ø.

**Material:**  
Sheet steel

**Surface finish:**  
Zinc-plated

Packs of	Model No. SO
10	2817.000



### Fastening bolts

- for
- TS base/plinth
  - Base/plinth, complete
  - Base/plinth, stationary

For mounting on base/plinth trim panels, side. The lockable assembly bolt allows the installation of cable clamp rails. Tighten with hex spanner, width across flats 19 mm.

**Material:**  
Hexagon steel

**Surface finish:**  
Zinc-plated

Base/plinth trim panel mm high	Packs of	Model No. SZ
100	10	2819.000
200	10	2819.200

### + Accessories:

Cable clamp rail, see page 527.

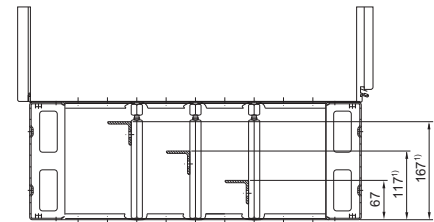
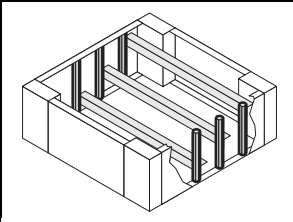

<sup>1)</sup> Only for height 200 mm



### Levelling component

for TS base/plinth  
For retrospective levelling of floor unevenness at the installation site up to a maximum of 15 mm. Installed through the corner piece of the base/plinth component. Adjusted using a SW 19 hex spanner.

#### Benefits:

- A door offset caused by uneven flooring can be corrected.
- Installed on the assembled enclosure, i.e. no need to plan levelling in advance.

Max. admissible static load:  
2500 N per levelling component  
(check the load capacity of the floor).

**Supply includes:**  
Assembly parts.

For base/plinth height mm	Packs of	Model No. SZ
100	4	2891.000
200	4	2892.000



### Cover cap

#### for TS base/plinth components

As a replacement.

**Material:**

Plastic ABS

**Colour:**

RAL 9005

For base/plinth height mm	Packs of	Model No. TS
100	4	<b>8601.130</b>
200	4	<b>8601.140</b>



### Base/plinth trim

#### with brush strip for TS base/plinth

To supplement the modular base/plinth concept. May also be exchanged retrospectively for the front or rear trim panel of the base/plinth components 100 mm high. Open on one side for retrospective mounting if cables have already been inserted.

**Material:**

Sheet steel

**Surface finish:**

Spray-finished

For base/plinth width mm	Height mm	Colour RAL	Model No. TS
600	100	7035	<b>7825.607</b>
800	100	7035	<b>7825.807</b>
600	100	9005	<b>7825.608</b>
800	100	9005	<b>7825.808</b>



### Connecting plinth trim

#### for TS base/plinth

For covering gaps in bayed back-to-back or corner enclosure suites. Simply push in between the trim panel and the corner piece before tightening the screws.

**Material:**

Sheet steel

**Note:**

For a base/plinth height of 200 mm, 2 trim panels must be fitted one above the other.

For base/plinth height mm	Colour RAL	Packs of	Model No. TS
100	7022	2	<b>8601.110</b>



# Base

## TS base/plinth



### Base/plinth trim

#### for TS base/plinth

- To continue the design of the
- lower front door of PC enclosures
  - door of the IW enclosure.

The base/plinth trim is screw-fastened to the corner pieces of the TS base/plinth components from the outside.

#### Material:

Sheet steel, spray-finished  
Designer trim panels: Extruded aluminium section

#### Colour:

RAL 7015  
Designer trim panels: RAL 7035

For base/plinth width mm	Height mm	Model No. PC
600	200	<b>8360.920</b>

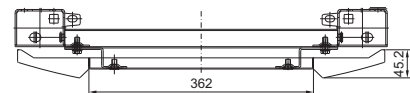
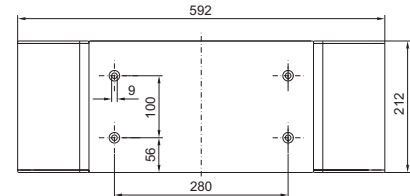

### Base/plinth, stationary

#### for PC-TS, IW

Design-coordinated with the enclosures, height 100 mm, with front projection.

#### Material:

Sheet steel, 2.0 mm

#### Colour:

RAL 7035  
Design component, front: RAL 7015

#### Supply includes:

- 1 design component, front
- 1 base/plinth component, rear
- 2 base/plinth trims, side

For depth mm	Model No. PC
600	<b>8800.920</b>



#### Accessories:

Attachment opportunities for:

- Twin castors DK 7495.000, see page 374,
- Levelling feet PS 4612.000, see page 373.
- Fastening bolt for cable clamp rails SO 2819.000, see page 364,
- Support bracket PS 4183.000, see page 473.



### Filter mat

#### for

- Base/plinth component, vented
- Base/plinth component, vented, with designer trim panel

To cover the trim panel in the base/plinth component.

The mounting frame slides into position behind the filter mat in the base/plinth trim panel.

Filter class G3 to DIN EN 779.

#### Supply includes:

Mounting frame.

For enclosure width mm	Packs of	Model No. DK
600	1	<b>7561.500</b>
800	1	<b>7581.500</b>

### Spare filter mat

Spare filter mat for base/plinth trim panels up to 800 mm wide.

	Packs of	Model No. DK
Spare filter mats	5	<b>7582.500</b>

### Base/plinth components front and rear

#### Stainless steel for TS

**Material:**  
Stainless steel 1.4301 (AISI 304)

**Surface finish:**  
Brushed, grain 400

**Supply includes:**  
Mounting accessories for mounting on the enclosure.

**100 mm high:**  
2 trim panels front/rear

**200 mm high:**  
– 2 corner pieces with removable trim panel  
– 1 trim panel front/rear

For enclosure width mm	Height mm	Model No. TS
600	100	8701.600
800	100	8701.800
1000	100	8701.000
1200	100	8701.200
600	200	8702.600
800	200	8702.800
1000	200	8702.000
1200	200	8702.200

#### + Accessories:

Base/plinth trim, modular (perforated plate), see page 367.

### Base/plinth trim panels, side

#### Stainless steel for TS

For mounting between the base/plinth components. At 200 mm height, two 100 mm base/plinth trims may be used.

Base/plinth trim (100 mm high) may be installed rotated through 90° in order to stabilise bayed base/plinth components.

**Material:**  
Stainless steel 1.4301 (AISI 304)

**Surface finish:**  
Brushed, grain 400

**Supply includes:**  
2 base/plinth trim panels, including parts for attaching to the base/plinth components.

For enclosure depth mm	Height mm	Model No. TS
400	100	8701.040
500	100	8701.050
600	100	8701.060
400	200	8702.040
500	200	8702.050
600	200	8702.060

#### ! Also required:

Base/plinth baying brackets TS 8601.100, see page 362, when mounting base/plinth trim panels rotated through 90°.

#### + Accessories:

- Fastening bolts for base/plinth, see page 364.
- Levelling feet PS 4612.000, see page 373.

#### Detailed drawings:

Available on the Internet.

### Base/plinth trim, modular

#### for

- TS base/plinth
- base/plinth, complete, stainless steel

For cable routing in the stainless steel base/plinth, e.g. if levelling feet SO 2890.000 or SO 2890.000, see page 371, are used.  
Width: 175 mm.

**Material:**  
Stainless steel 1.4301 (AISI 304)

**Supply includes:**  
4 base/plinth trim panels.

**Note:**  
One base/plinth trim panel is needed per 200 mm base/plinth width.

For enclosure depth mm	Packs of	Model No. SO
400	4	2907.000
500	4	2908.000
600	4	2913.000

#### + Accessories:

Cable tie SZ 2597.000, see page 530.



# Base

## Base/plinths



### Transport plinth

#### for TS

For the transportation of heavy, bayed enclosure suites. Available in 200 mm increments from 2 to 5 m.

Transport plinths can have 2 tubes welded to receive cross-bars for transportation. Variable punchings to suit all enclosure widths of 600 mm and above.

#### Surface finish:

Primed in reddish-brown rust-inhibiting paint, optionally spray-finished.

#### Supply includes:

With transport tubes.

#### Note:

Please state the required width and depth of the enclosure suite when ordering.

#### For mounting on the TS base frame

Transport plinth depth = enclosure depth – 31 mm	Packs of	Model No. SO
Colour		
Primed, reddish-brown rust-inhibiting paint	1	<b>1228.010</b>
Similar to RAL 7022	1	<b>1228.110</b>
Similar to RAL 7035	1	<b>1228.310</b>

Delivery times available on request.

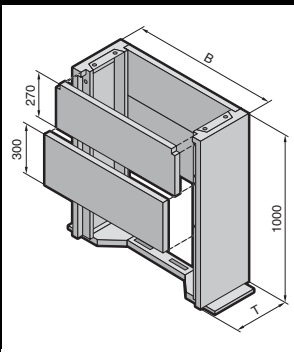

### Concrete base/plinth

#### for CS Toptec, CS modular and basic enclosures

The base/plinth is made from pre-cast concrete sections which are easily fitted in situ. Front/rear base/plinth plate screw-fastened from the inside may be removed for servicing purposes.

Overall height: approx. 1000 mm, Excavation depth: approx. 700 mm.

#### Material:

Light-weight concrete

#### Surface finish:

Untreated

#### Supply includes:

- 1 base plate
- 2 side parts
- 2 divided base/plinth plates
- Assembly parts and fastening screws for mounting the enclosure.

For CS modular and basic enclosures		Model No. CS
Width (B) mm	Depth (T) mm	
600	400	<b>9765.182</b>
600	500	<b>9765.082</b>
600	600	<b>9765.083</b>
800	400	<b>9765.088</b>
800	500	<b>9765.084</b>
800	600	<b>9765.085</b>
1200	400	<b>9765.089</b>
1200	500	<b>9765.086</b>
1200	600	<b>9765.087</b>

Delivery times available on request.

For CS Toptec		Model No. CS
Width (B) mm	Depth (T) mm	
600	600	<b>9765.071</b>
800	600	<b>9765.072</b>

Delivery times available on request.



### Base/plinth, complete

#### Sheet steel for AE, TP, ES

Trim panels at the front and rear with fitted corner pieces and side trim panels.

#### Material:

Sheet steel

#### Surface finish:

Spray-finished

#### Colour:

RAL 7022

#### Supply includes:

Mounting accessories for mounting on the enclosure.

#### 100 mm high:

- 4 corner pieces
- 2 trim panels front/rear
- 2 trim panels, side

#### 200 mm high:

- 4 corner pieces
- 1 trim panel front/rear x 200 mm
- 2 trim panels front/rear x 100 mm
- 4 trim panels, side

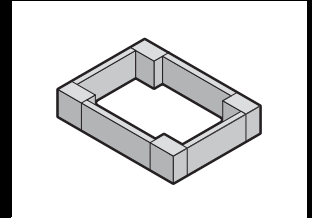

#### Base/plinth for ES, TP universal console, 100 mm high

For enclosures/consolas		Base/plinth depth mm	Model No. SO
Width (B) mm	Depth (T) mm		
600	400	350	<b>2804.200</b>
600	500	450	<b>2807.200</b>
800	400	350	<b>2823.200</b>
800	500	450	<b>2829.200</b>
1000	400	350	<b>2909.200</b>
1200	400	350	<b>2836.200</b>
1200	500	450	<b>2839.200</b>
1600	400	350	<b>2905.200</b>
1800	500	450	<b>2903.200</b>

#### Base/plinth for ES, TP universal console, 200 mm high

For enclosures/consolas		Base/plinth depth mm	Model No. SO
Width (B) mm	Depth (T) mm		
600	400	350	<b>2805.200</b>
600	500	450	<b>2808.200</b>
800	400	350	<b>2824.200</b>
800	500	450	<b>2830.200</b>
1000	400	350	<b>2910.200</b>
1200	400	350	<b>2837.200</b>
1200	500	450	<b>2840.200</b>
1600	400	350	<b>2906.200</b>
1800	500	450	<b>2904.200</b>

#### Base/plinth for AE, 100 mm high

For enclosures		Base/plinth depth mm	Model No. SO
Width (B) mm	Depth (T) mm		
600	300	279	<b>2816.200</b>
800	300	279	<b>2818.200</b>
1000	300	279	<b>2801.200</b>

#### Base/plinth for AE, 200 mm high

For enclosures		Base/plinth depth mm	Model No. SO
Width (B) mm	Depth (T) mm		
600	300	279	<b>2826.200</b>
800	300	279	<b>2828.200</b>
1000	300	279	<b>2802.200</b>



#### Accessories:

- Fastening bolt, see page 364.
- Base mounting plate, see page 364.

#### Detailed drawings:

Available on the Internet.

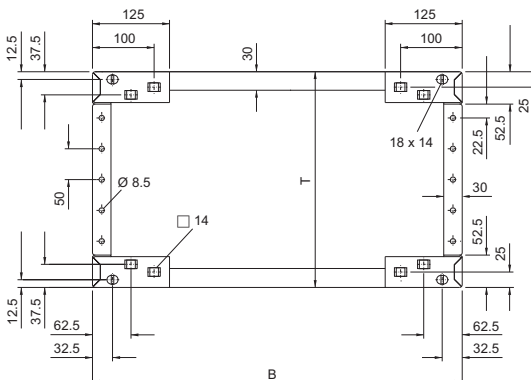

#### Base/plinth, 100 mm high



#### Base/plinth, 200 mm high

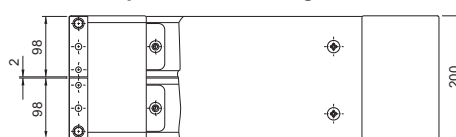

# Base

## Base/plinths

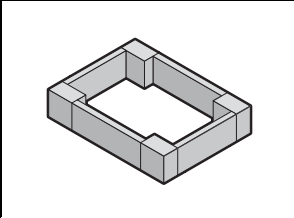

### Base/plinth, complete

**Stainless steel**  
for ES, PC-ES stainless steel,  
AP stainless steel

**Material:**  
Stainless steel 1.4301 (AISI 304)

**Surface finish:**  
Brushed

**Supply includes:**

Mounting accessories for mounting on the enclosure.

**100 mm high:**  
– 2 trim panels front/rear  
– 2 trim panels, side

**200 mm high:**  
– 2 corner pieces with removable trim panel  
– 1 trim panel front/rear  
– 4 trim panels, side

**+ Accessories:**

- Levelling feet, see page 371.
- Base/plinth trim, modular (perforated plate), see page 367.

**100 mm high**

For enclosures		Model No. SO
Width mm	Depth mm	
600	400	<b>2865.000</b>
600	500	<b>2868.000</b>
600	600	<b>2855.000</b>
800	400	<b>2869.000</b>
800	500	<b>2866.000</b>
800	600	<b>2856.000</b>
1000	400	<b>2867.000</b>
1200	400	<b>2870.000</b>
1200	500	<b>2860.000</b>

**200 mm high**

For enclosures		Model No. SO
Width mm	Depth mm	
600	400	<b>2875.000</b>
600	500	<b>2876.000</b>
800	400	<b>2878.000</b>
800	500	<b>2879.000</b>
800	600	<b>2880.000</b>
1000	400	<b>2885.000</b>
1200	400	<b>2886.000</b>
1200	500	<b>2887.000</b>



### Transport castors

**for base/plinth, complete, sheet steel**  
For locating onto the base/plinth corner piece  
100 or 200 mm high by raising or tilting.

**Load capacity:**  
Maximum permissible static load:  
100 kg per twin castor

**Colour:**  
RAL 7022

**Supply includes:**  
1 set =  
4 twin castors,  
2 x with, 2 x without locks.

Floor clearance mm	Model No. PS
60	<b>4570.000</b>



### Cross member

**for TS, CM, TP, PC, IW, ES**  
**adjustable**

- To increase stability
- Height 70 mm
- Adjustable from the enclosure depth

To increase stability, the cross member is positioned 138 mm above the base frame of the enclosure at the front and rear. For deeper enclosures, the rear part may be extended and screw-fastened again. For screw-fastening to the floor and enclosure with mounting hole at the sides, front and rear. The castors and levelling feet may be secured to the welded nuts M12.

**Material:**  
Sheet steel

**Surface finish:**  
Spray-finished

**Colour:**  
RAL 7015

For enclosure depth mm	Packs of	Model No. TS
400	2	<b>8601.450</b>
500		
600	2	<b>8601.680</b>
800		

**+ Accessories:**

- Attachment opportunities for
- Twin castors DK 7495.000, see page 374,
  - Levelling feet PS 4612.000, see page 373.

**Detailed drawings:**  
Available on the Internet.



### Cast feet

For secure siting of  
 ● Enclosure for tower PC  
 or  
 ● Other own assemblies

Depth 700 mm

**Material:**  
 Cast aluminium

**Colour:**  
 RAL 7035

**Supply includes:**  
 Assembly parts.

Packs of	Model No. IW
2	6902.920

#### Accessories:

- Base mount CP 6147.000, see page 151.
- Twin castors, see page 374.



### Levelling feet

For direct mounting underneath the base/plinth TS and the base/plinth, complete.  
 For unhindered access e.g. when cleaning the floor, and to compensate for floor irregularities.

**Load capacity:**  
 Maximum permissible static load:  
 400 kg per levelling foot

**Adjustment range:**  
 M12: 55 mm – 125 mm  
 M16: 45 mm – 120 mm

**Material:**  
 Stainless steel 1.4301 (AISI 304)

Thread	Packs of	Model No. SO
M12	4	2889.000
M16	4	2890.000

#### Possible alternative:

Levelling feet Hygienic Design, see page 156.



### Base/plinth

#### for FlatBox

The base/plinth may be mounted on any FlatBox with a base area of 600 x 600 or 700 x 700 mm. For attachment purposes, the base/plinth may be mounted on the pre-existing thread in the base area of the FlatBox. There is a rear recess provided for cable entry.

**Material:**  
 Sheet steel

**Surface finish:**  
 Powder-coated

**Colour:**  
 RAL 7035

**Supply includes:**  
 4 levelling feet and assembly parts.

For base area		Packs of	Model No. DK
Width mm	Depth mm		
600	600	1	7507.750
700	700	1	7507.755



# Base

## Base/plinths

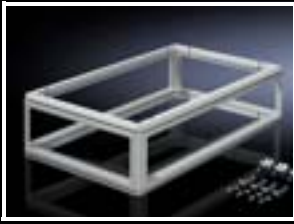

### Under-floor frame

#### for DK-TS

For siting the enclosure on a false floor when heavy equipment is installed.

**Material:**  
Sheet steel

**Colour:**  
RAL 7035

**Supply includes:**  
Mounting accessories for mounting on the enclosure.

Width mm	Height mm	Depth mm	Model No. DK
600	400	1000	<b>7855.340</b>
800	400	1000	<b>7855.342</b>

Delivery times available on request.

### Stabiliser bracket

#### for base/plinth TS

The stabiliser bracket may be retrospectively screw-fastened to the outside of the base/plinth corner pieces.

**Load capacity:**  
Up to a maximum of 80 kg static load.

**Material:**  
Sheet steel

**Surface finish:**  
Spray-finished

**Colour:**  
RAL 7035, warning markings RAL 2002

**Supply includes:**  
Assembly parts.

Packs of	Model No. DK
2	<b>7825.150</b>

Delivery times available on request.

### Stabiliser

#### for TS 8 server enclosures

The pull-out stabiliser is quickly and easily retrofitted to the lower frame of the server racks and only extended when necessary.

**Load capacity:**  
Up to a maximum of 150 kg static load.

**Material:**  
Sheet steel

**Surface finish:**  
Zinc-plated

**Supply includes:**  
Assembly parts.

**Note:**

- The stabiliser cannot be used together with base plates, base frames or base/plinths.
- Combined use with the divided base frame (DK 7825.342), see page 377, is supported.

Enclosure depth mm	Model No. DK
1000	<b>7825.250</b>
1200	<b>7825.260<sup>1)</sup></b>

<sup>1)</sup> Delivery times available on request.

#### Accessories:

- Levelling feet, see page 373 and/or
- Transport kit for DK-TS, see page 375.

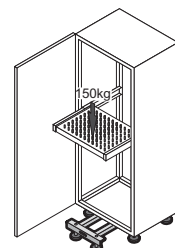

### Levelling feet

#### 18 – 43 mm high

To compensate for height differences with floor irregularities. Thread length 40 mm. Assembly thread M12.

Max. admissible static load: approx. 300 kg per levelling foot.

#### For:

- Baying system TS 8
- PC enclosure system
- Pedestal base plate CP 6137.035 – CP 6137.535
- Pedestal CP 6141.XXX
- Industrial workstations

Packs of	Model No. PS
4	4612.000

#### ! Also required:

For mounting on the TS base/plinth: Base/plinth adaptor TS 8800.220, see page 375.

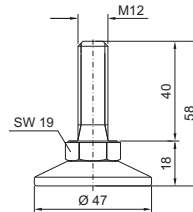

### Levelling feet

#### 18 – 63 mm high, with hex socket for baying system TS 8

To compensate for floor irregularities. Particularly in confined spaces, adjustments can be made quickly and easily from the enclosure interior.

Mounting thread: M12  
Hex socket: 6 mm  
Thread length: 60 mm

Max. admissible static load: 300 kg per levelling foot.

Packs of	Model No. DK
4	7493.100

#### ! Also required:

For mounting on the TS base/plinth: Base/plinth adaptor TS 8800.220, see page 375.

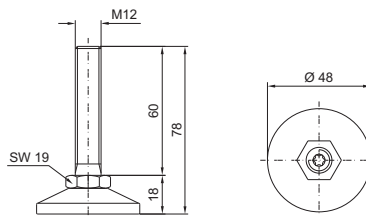

### Levelling feet

#### with vibration dampening

For vibration insulation of enclosures and to compensate for floor irregularities.

The levelling foot is comprised of a disc of reinforced polyamide and an M12 screw, zinc-plated, with ball joint pendulum plus anti-slip and insulating plate for buffering.

The insulating plate is resistant to water, mineral oils, petrol, alkaline and acid solutions, salts, soap lye and detergents.

Also suitable for special applications such as chemical and laboratory environments.

Thread length: 50 mm

Max. admissible static load: 300 kg per levelling foot.

Packs of	Model No. DK
4	7493.230

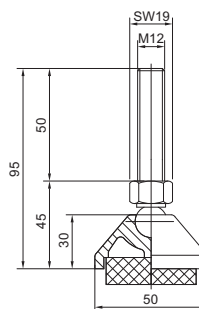

### Levelling feet

#### for Data Rack

To compensate for height differences with floor irregularities.

The levelling feet are attached into the die-cast zinc feet of the base/plinth.

#### Supply includes:

4 levelling feet M12, levelling range 40 mm.

Packs of	Model No. DK
4	7493.000



# Base

## Base



### Levelling feet

for FlatBox, TE  
M10 x 20 mm

For screw-fastening onto the enclosure base when used as a floor-standing or desktop enclosure.

Width across flats 17, mounting thread multi-tooth 30.

Packs of	<b>Model No. DK</b>
4	<b>7507.740</b>



### Levelling feet

85 - 115 mm high

For mounting on TS, ES and PC enclosures, for easier floor cleaning and to compensate for floor irregularities ±15 mm.

Height 100 mm.

Max. admissible static load:  
350 kg per levelling foot.

#### Material:

- Feet: Brass, nickel-plated
- Threaded bolts and mounting plates:  
Stainless steel 1.4301 (AISI 304)

#### Supply includes:

Assembly parts to the enclosure.

Packs of	<b>Model No. SO</b>
4	<b>2859.000</b>

#### Possible alternative:

Levelling feet Hygienic Design, see page 156.



### Twin castors

Mounting thread M12 x 20.

#### For:

- Baying system TS 8
- PC enclosure system
- Pedestal base plate  
CP 6137.035 - CP 6137.535
- Pedestal CP 6141.XXX
- TopConsole pedestals
- Industrial workstations
- Data Rack

#### ! Also required:

For mounting on the TS base/plinth:  
Base/plinth adaptor for twin castors TS 8800.290, see page 375.

	Max. permissible static load (per castor)	40 kg
	Ground clearance	50 mm
<b>1</b>	Lock	4 without
	Packs of	1 set
	Colour	Black
	<b>Model No. PS</b>	<b>4611.000</b>



	Max. permissible static load (per castor)	75 kg
	Ground clearance	85 mm
<b>2</b>	Lock	2 with, 2 without
	Packs of	1 set
	Colour	Black with grey running surface
	<b>Model No. CP</b>	<b>6148.000</b>



	Max. permissible static load (per castor)	120 kg
	Ground clearance	125 mm
<b>3</b>	Lock	2 with, 2 without
	Packs of	1 set
	Colour	Black
	<b>Model No. DK</b>	<b>7495.000</b>

### Transport castors

#### for TE

The castors may be screw-fastened in the corner areas within the base frame in place of the levelling feet.

Ground clearance: 58 mm,  
Mounting thread M10 x 20.

#### Permissible static load:

300 kg per enclosure

Packs of	Model No. TE
1 set	7000.672

#### Supply includes:

1 set = 4 baying clamps,  
including assembly parts.



### Transport kit

#### for DK-TS

Ground clearance: approx. 40 mm.

#### Permissible static load:

750 kg per enclosure

#### Supply includes:

1 set =  
4 castors (2 steerable) including assembly parts.

Packs of	Model No. DK
1 set	7825.900

#### Note:

Only for enclosures without gland plates or gland plate frames.

For 800 mm wide enclosures with 482.6 mm (19") mounting frame, special installation dimensions must be observed (see drawing).

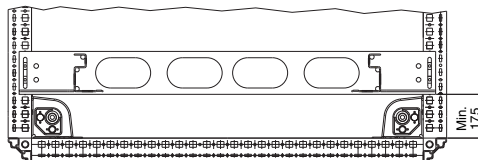

### Base/plinth adaptor

#### for levelling feet

Connection component for fastening M12 levelling feet PS 4612.000 to the TS base/plinth.

#### Material:

Sheet steel

#### Surface finish:

Zinc-plated

Packs of	Model No. TS
4	8800.220



#### Also required:

Levelling feet, PS 4612.000,  
see page 373.



### Base/plinth adaptor

#### for twin castors

Connection component for mounting twin castors to the TS and TE base/plinth.

#### Material:

Sheet steel

#### Surface finish:

Zinc-plated

Packs of	Model No. TS
4	8800.290



#### Also required:

Base/plinth trim panels, side,  
see page 362,  
wherever a twin castor is fitted.



# Base

## Base



### Width divider

Divides 1200 mm wide TS enclosures into two halves.

**Material:**  
Sheet steel

**Surface finish:**  
Zinc-plated

**Supply includes:**  
1 set =  
1 bracket for right/left,  
2 compensating plates for the top,  
mounting accessories.

Packs of	Model No. TS
1 set	8800.200

**!** **Also required:**

Depending on the installation situation:

- TS punched rail 18 x 38 mm, see page 462.
- PS punched section without mounting flange, 23 x 73 mm, see page 464.



**1. Mounting position:**  
**Two mounting plates side by side.**  
Two mounting plates (from 600 mm wide enclosures) in a 1200 mm wide enclosure permit independent positioning and easy handling.

**!** **Also required:**

In accordance with the enclosure depth:

- 4 TS punched rails 18 x 38 mm, bottom, see page 462.
- 1 PS punched section without mounting flange 23 x 73 mm at the top, see page 464.

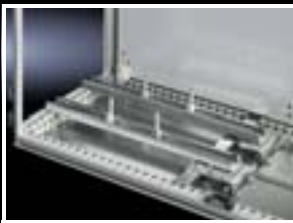

**2. Mounting position:**  
**System support rails, fitted on the left.**  
Whilst heavy installed equipment rests on the system support rails, the remaining floor space is free, e.g. for unhindered cable entry.

**!** **Also required:**

- 2 system support rails PS 4361.000, see page 466.
- 1 TS punched rail 18 x 38 mm in accordance with the enclosure depth (included with the supply of the standard enclosure).

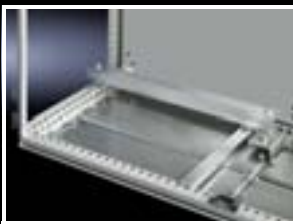

**3. Mounting position:**  
**Cable clamp rail, installed on the left.**  
With 1200 mm wide enclosures, the width divider allows cable entry and cable clamping to be arranged differently on the left and right of the enclosure.

**!** **Also required:**

- 1 cable clamp rail PS 4191.000, see page 527.
- 1 TS punched rail 18 x 38 mm in accordance with the enclosure depth (included with the supply of the standard enclosure).



### Base mounting bracket

for TS, ES, TP universal console

For anchoring the enclosure at any position of the base frame, particularly in cases where the existing holes in the frame or base tray cannot be used due to the installed equipment or because the substructure prevents them from being used.

**Material:**  
Sheet steel

**Surface finish:**  
Zinc-plated

Packs of	Model No. TS
4	8800.210

**Note:**  
Additional holes in the base are required for mounting.

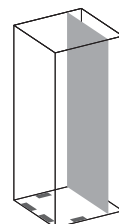



### Reinforcement bracket

#### for TS, ES, TP universal console

For use as an additional stabiliser to the clamping straps when populated enclosures are screw-fastened via the base tray to the base/plinth or pallet for transportation purposes.

**Material:**

Sheet steel

**Surface finish:**

Zinc-plated

**Supply includes:**

Assembly parts.

Packs of	<b>Model No. TS</b>
4	<b>8800.830</b>



### Base frame, divided

#### for TS 8 server enclosures

For retro-fitting gland plates or base modules. Suitable for combining with the pull-out stabiliser.

**Material:**

Sheet steel

**Surface finish:**

Zinc-plated

**Supply includes:**

Packs of 1 set  
Frame elements, assembly parts.

For enclosures		<b>Model No. DK</b>
Width mm	Depth mm	
600	1000	<b>7825.342</b>



**Accessories:**

- Multi-piece gland plate, see page 381.
- Stabiliser, see page 372.

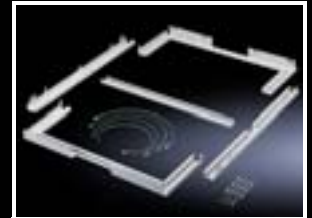

### Clips

#### for gland plates

As replacement and for additional gland plate attachments in TS, CM, TP.

**Material:**

Sheet steel

**Surface finish:**

Zinc-plated

Packs of	<b>Model No. TS</b>
50	<b>8800.075</b>



# Base

## Base



### Gland plate

for CM, TopConsole TP and one-piece console TP

Select suitable gland plates depending on the application. The following examples illustrate the individual options for cable entry structuring. Potential equalisation is provided via assembly components and earthing points.

**Material:**

Sheet steel

**Surface finish:**

Zinc-plated

**Protection category:**

IP 55 to IEC 60 529, subject to correct mounting.

**Supply includes:**

1 piece, including assembly parts.

**Note:**

For greater stability and universal cable entry, the base opening is divided in the width for 1000, 1200 and 1600 mm wide enclosures, and is suitable for various configurations.

### For enclosure depth 300 mm, complete module groups

	For enclosure/console depth mm									
	One-piece base opening				Two-piece base opening					
For enclosure width			600		800		1000		1200	1600
Cable entry module groups	Packs of	Requires packs of	Model No.		Packs of	Requires packs of	Model No.			

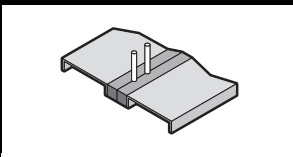

#### Cable clamp strip, centre

Gland plate, depth 50 mm	1	2	5001.210	5001.211	1	4	5001.212	5001.213	5001.233
Section for cable entry, centre	1 set	1	8802.060	8802.080	2 sets	1	8802.100	8802.120	8802.160

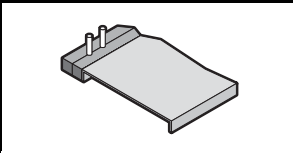

#### Cable clamp strip, rear

Gland plate, depth 100 mm	1	1	5001.214	5001.215	1	2	5001.216	5001.217	5001.234
Section for cable entry, rear	1 set	1	8802.065	8802.085	2 sets	1	8802.105	8802.125	8802.165

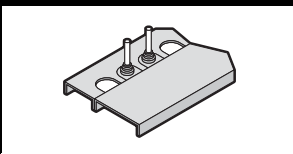

#### Grommets, 1 x

Gland plate, depth 50 mm	1	1	5001.210	5001.211	1	2	5001.212	5001.213	5001.233
Cable entry plates for grommets	1	1	5001.226	5001.227	1	1	5001.228	5001.229	5001.237

Cable entry and connector grommets, see page 512.

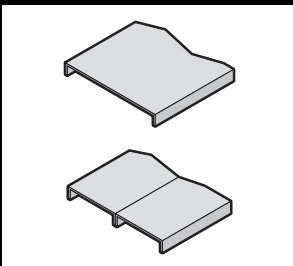

#### For cable glands

##### One-piece

Gland plate, depth 150 mm	1	1	5001.218	5001.219	1	2	5001.220	5001.221	5001.235
---------------------------	---	---	----------	----------	---	---	----------	----------	----------

##### Two-piece

Gland plate, depth 50 mm	1	1	5001.210	5001.211	1	2	5001.212	5001.213	5001.233
Gland plate, depth 100 mm	1	1	5001.214	5001.215	1	2	5001.216	5001.217	5001.234

Cable glands, see page 519.

### For enclosure depth 400 mm, complete module groups

	For enclosure/console depth mm								
	One-piece base opening				Two-piece base opening				
For enclosure width			600	800			1000	1200	1600
Cable entry module groups	Packs of	Requires packs of	Model No.		Packs of	Requires packs of	Model No.		

#### Cable clamp strip, centre

Gland plate, depth 50 mm	1	1	5001.210	5001.211	1	2	5001.212	5001.213	5001.233
Gland plate, depth 150 mm	1	1	5001.218	5001.219	1	2	5001.220	5001.221	5001.235
Section for cable entry, centre	1 set	1	8802.060	8802.080	2 sets	1	8802.100	8802.120	8802.160

#### Cable clamp strip, rear

Gland plate, depth 100 mm	1	2	5001.214	5001.215	1	4	5001.216	5001.217	5001.234
Section for cable entry, rear	1 set	1	8802.065	8802.085	2 sets	1	8802.105	8802.125	8802.165

#### Cable clamp strip, centre and rear

Gland plate, depth 50 mm	1	1	5001.210	5001.211	1	2	5001.212	5001.213	5001.233
Gland plate, depth 100 mm	1	1	5001.214	5001.215	1	2	5001.216	5001.217	5001.234
Section for cable entry, centre	1 set	1	8802.060	8802.080	2 sets	1	8802.100	8802.120	8802.160
Section for cable entry, rear	1 set	1	8802.065	8802.085	2 sets	1	8802.105	8802.125	8802.165

#### Grommets, 1 x

Gland plate, depth 150 mm	1	1	5001.218	5001.219	1	2	5001.220	5001.221	5001.235
Cable entry plates for grommets	1	1	5001.226	5001.227	1	2	5001.228	5001.229	5001.237

Cable entry and connector grommets, see page 512.

#### Grommets, 2 x

Gland plate, depth 50 mm	1	1	5001.210	5001.211	1	2	5001.212	5001.213	5001.233
Cable entry plates for grommets	1	2	5001.226	5001.227	1	4	5001.228	5001.229	5001.237

Cable entry and connector grommets, see page 512.

#### EMC

EMC gland plate	1 set	1	8800.660	8800.680	1 set	2	8800.600	8800.620	–
Gland plate, depth 100 mm	1	1	5001.214	5001.215	1	2	5001.216	5001.217	–

Cable entry and connector grommets, see page 512.

#### For cable glands

##### One-piece

Gland plate, depth 250 mm	1	1	5001.222	5001.223	1	2	5001.224	5001.225	5001.236
---------------------------	---	---	----------	----------	---	---	----------	----------	----------

##### Two-piece

Gland plate, depth 150 mm	1	1	5001.218	5001.219	1	2	5001.220	5001.221	5001.235
Gland plate, depth 100 mm	1	1	5001.214	5001.215	1	2	5001.216	5001.217	5001.234

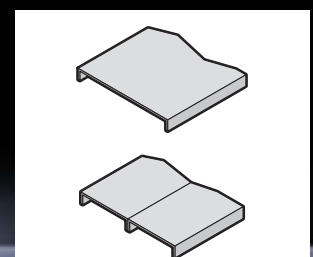
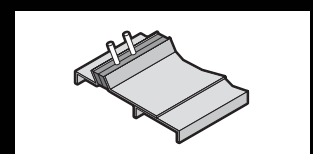
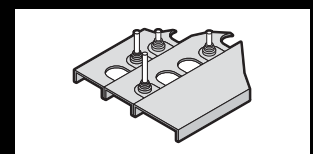
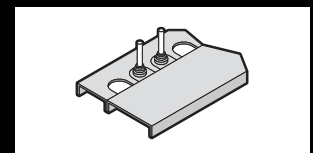
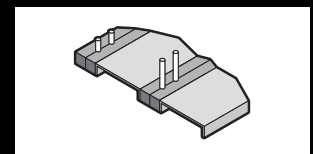
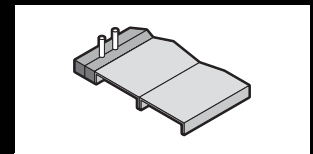
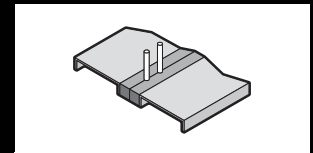

Cable glands, see page 519.



# Base

## Base

### For enclosure depth 500 mm, complete module groups

	For enclosure/console depth mm								
	One-piece base opening				Two-piece base opening				
									
For enclosure width	Packs of	Requires packs of	600	800	Packs of	Requires packs of	1000	1200	1600
Cable entry module groups			Model No.				Model No.		

#### Cable clamp strip, centre

Gland plate, depth 50 mm	1	1	5001.210	5001.211	1	2	5001.212	5001.213	5001.233
Gland plate, depth 250 mm	1	1	5001.222	5001.223	1	2	5001.224	5001.225	5001.236
Section for cable entry, centre	1 set	1	8802.060	8802.080	2 sets	1	8802.100	8802.120	8802.160

#### Cable clamp strip, rear

Gland plate, depth 150 mm	1	2	5001.218	5001.219	1	4	5001.220	5001.221	5001.235
Section for cable entry, rear	1 set	1	8802.065	8802.085	2 sets	1	8802.105	8802.125	8802.165

#### Cable clamp strip, centre and rear

Gland plate, depth 50 mm	1	1	5001.210	5001.211	1	2	5001.212	5001.213	5001.233
Gland plate, depth 100 mm	1	2	5001.214	5001.215	1	4	5001.216	5001.217	5001.234
Section for cable entry, centre	1 set	1	8802.060	8802.080	2 sets	1	8802.100	8802.120	8802.160
Section for cable entry, rear	1 set	1	8802.065	8802.085	2 sets	1	8802.105	8802.125	8802.165

#### Grommets, 1 x

Gland plate, depth 250 mm	1	1	5001.222	5001.223	1	2	5001.224	5001.225	5001.236
Cable entry plates for grommets	1	1	5001.226	5001.227	1	2	5001.228	5001.229	5001.237

Cable entry and connector grommets, see page 512.

#### Grommets, 2 x

Gland plate, depth 150 mm	1	1	5001.218	5001.219	1	2	5001.220	5001.221	5001.235
Cable entry plates for grommets	1	2	5001.226	5001.227	1	4	5001.228	5001.229	5001.237

Cable entry and connector grommets, see page 512.

#### EMC

EMC gland plate	1 set	1	8800.660	8800.680	1 set	2	8800.600	8800.620	–
Gland plate, depth 100 mm	1	2	5001.214	5001.215	1	4	5001.216	5001.217	–

Cable entry and connector grommets, see page 512.

#### For cable glands, two-piece

Gland plate, depth 100 mm	1	1	5001.214	5001.215	1	2	5001.216	5001.217	5001.234
Gland plate, depth 250 mm	1	1	5001.222	5001.223	1	2	5001.224	5001.225	5001.236

Cable glands, see page 519.

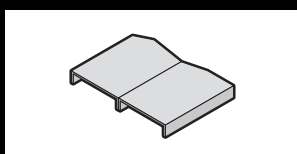
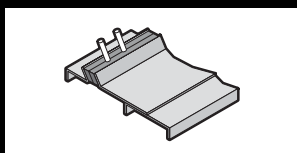
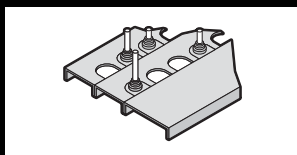
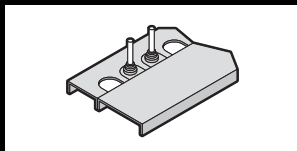
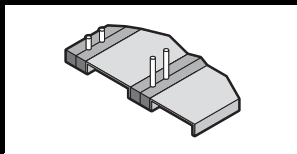
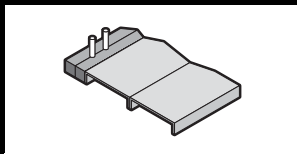
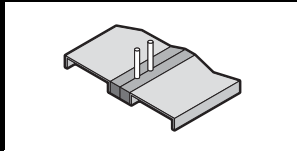

### Trim panel

#### for CM

To conceal the entire base opening.

#### Material:

Sheet steel

#### Surface finish:

Textured paint

#### Colour:

RAL 7035

#### Protection category:

IP 55 to IEC 60 529

#### Supply includes:

Assembly parts.

For enclosure		Model No. CM
Width mm	Depth mm	
600	400	<b>5001.130</b>
800	400	<b>5001.140</b>
1000	400	<b>5001.150</b>
1200	400	<b>5001.160</b>



### Gland plate, multi-piece

#### for DK-TS

Any combination possible

#### Material:

Sheet steel

#### Surface finish:

Zinc-plated

#### Supply includes:

Packs of 1 set

Gland plates including sliding plate for cable entry, including sealing tape and assembly parts.

#### Note:

For the size variant 800 x 800 mm, the gland plate included with the supply of pre-configured network enclosures should be additionally used.

For enclosures		Model No. TS
Width mm	Depth mm	
600	1000	<b>7825.364</b>
600	1200	<b>7825.365</b>
800	800	<b>7825.382</b>
800	1000	<b>7825.384</b>
800	1200	<b>7825.385</b>



#### Also required:

For integration of the gland plates, there must be a base frame inside the enclosure. Base frame, divided, for retro-fitting, see page 377.



#### Accessories:

All gland plates with a depth of 237.5 mm may be exchanged for gland plate modules on request.

- Gland plate modules, see page 382.
- Gland plate modules, vented with airflow regulator, see page 382.
- Base module for cable entry, see page 383.
- Section for cable entry, see page 512, 513.

### One-piece gland plate

#### vented, for TS

- With ventilation holes
- Cut-out for cable entry at the rear, covered with brush strip.

#### Material:

Sheet steel

#### Surface finish:

Zinc-plated

#### Supply includes:

Assembly parts.

For enclosures		Model No. DK
Width mm	Depth mm	
600	600	<b>7825.660</b>
600	800	<b>7825.680</b>
600	1000	<b>7825.610</b>
800	600	<b>7825.860</b>
800	800	<b>7825.880</b>
800	1000	<b>7825.810</b>
600	1200	<b>7825.612</b>
800	1200	<b>7825.812</b>



#### Accessories:

Filter mat for gland plate, see page 382.

# Base

## Base



### Filter mat

#### for one-piece gland plate

The filter mat may be cut to size according to the required cut-out.

#### Material:

PPI 35-5/polyamide

Packs of	Model No. DK
1	7825.620



### Gland plate modules

#### for DK-TS

For use in the base frame of the network enclosure. Used in exchange for an existing gland plate of the same depth or in conjunction with a multi-piece gland plate for pre-configured TS 8 enclosures, see page 381.

#### Gland plate depth:

237.5 mm

#### Version for cable entry at the rear:

With brush strip.

#### Version for cable entry at the sides:

With rubber cable clamp strip.

#### Vented design:

With filter mat for concealing the holes and nylon tape for securing from the inside or outside.

For enclosure width mm	Design	Model No. DK
600	For cable entry, rear	7825.361
800		7825.381
800	For cable entry, sides	7825.388
600	Vented	7825.360
800		7825.380

#### Material:

Sheet steel

#### Surface finish:

Zinc-plated

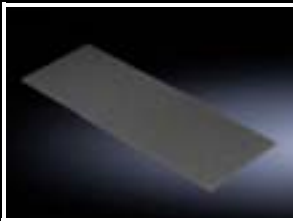

### Spare filter mat

#### for gland plate modules, vented

To be used in exchange for the existing filter mat.

#### Material:

PPI 35-5/polyamide

#### Supply includes:

Assembly parts.

Packs of	Model No. DK
2	7825.350



### Gland plate modules, vented

#### with airflow regulator for DK-TS

Allows controlled air routing from the twin base to the installed components. Individually adjustable membranes allow control of the air inlet opening between 10% and 80% free space.

If the rear area of the enclosure is partitioned by base/gland plates, the required volumetric airflow may be individually regulated, and distribution of the airflow inside the twin base adapted to suit the requirements of each enclosure.

The gland plate module may be combined with all gland plates as required. Gland plate module including contacting assembly screws; the additional installation of PE conductors is not required.

#### Material:

Sheet steel

#### Supply includes:

- Packs of 1
- Gland plate module, vented
- Filter mat
- Assembly parts

For enclosure width mm	Model No. DK
600	7825.366
800	7825.386



#### Also required:

For integration of the gland plates, there must be a base frame inside the enclosure. Base frame, divided, for retro-fitting, see page 377.



#### Accessories:

Spare filter mat, see page 383.



### Spare filter mat

for gland plate modules, vented, with airflow regulator

To be used in exchange for the existing filter mat.

**Material:**

PPI 35-5/polyamide

**Supply includes:**

Assembly parts.

Packs of	Model No. DK
1	<b>7825.622</b>

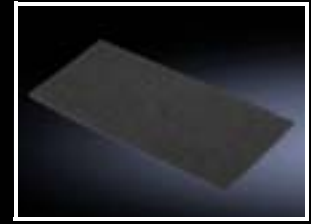

### Base module for cable entry

Super-airtight for DK-TS

The two-part base module has a special cable entry with alternate offset brush strips which guarantee an excellent seal even with large cable quantities.

**Material:**

- Module plate: Sheet steel
- Brush strip: Plastic, UL 94-V0

**Surface finish:**

Module plate: Zinc-plated

**Supply includes:**

Brush strip and assembly parts.

For enclosure width mm	Packs of	Model No. DK
600	1	<b>7825.367</b>
800	1	<b>7825.387</b>



### Module plates for TE

The base area of the TE may be varied as required using the module plates.

**Material:**

Sheet steel

**Supply includes:**

Assembly parts.

Design	Width mm	Depth mm	Model No. TE
Solid	450	200	<b>7526.760</b>
	450	550	<b>7526.770</b>
	450	750	<b>7526.780</b>
	650	550	<b>7526.785<sup>1)</sup></b>
	650	200	<b>7526.800</b>
With brush strip	650	750	<b>7526.820<sup>1)</sup></b>
	450	200	<b>7526.850</b>
Vented	650	200	<b>7526.860</b>
	450	200	<b>7526.829</b>
Compensating panel	650	200	<b>7526.834</b>
	450	50	<b>7526.750</b>
	450	150	<b>7526.755</b>
	650	50	<b>7526.790</b>
	650	150	<b>7526.795</b>

<sup>1)</sup> Extended delivery times.

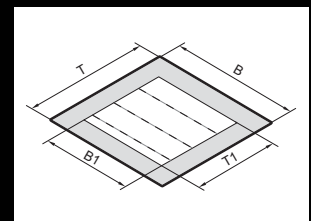

Enclosure dimensions mm	W (B)	600	600	600	800	800	800
	D (T)	600	800	1000	600	800	1000
Base cut-out dimensions mm	W (B1)	450	450	450	650	650	650
	D (T1)	550	750	950	550	750	950

# Base

## Base



### Pressure relief stopper

Especially when enclosures are exposed to changing climatic conditions (e.g. with outdoor siting), condensation may form in sealed enclosures due to pressure differences. The integral sealing membrane largely prevents such pressure differences and hence condensation; additionally, it also prevents the ingress of moisture from the outside.

Installed in vertical surfaces to protect against dirt.

Packs of	Model No. SZ
5	2459.500

#### Technical specifications:

- Air permeability up to 120 litres/hour with a pressure difference of 70 mbar
- Connection thread M12 x 1.5
- For fitting in wall thicknesses up to 4 mm

#### Material:

Polyamide

#### Colour:

Similar to RAL 9005

#### Protection category:

- IP 66, 68 to EN 60 529
- IP 69K to DIN 40 050-9

#### Supply includes:

Lock nut



### Condensate discharge

For reliable discharge from the inside and protection against splashes from the outside (labyrinth effect).

A hole diameter of 16 mm is required. (With AE sheet steel, the holes are already provided in the base.)

#### Material:

Polyamide

#### Colour:

Similar to RAL 7035

#### Protection category:

IP 55 to IEC 60 529, subject to correct mounting at the bottom.

Packs of	Model No. SZ
6	2459.000

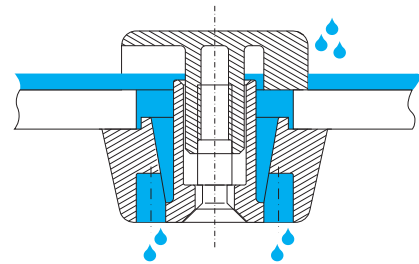

### Gland plates

#### for CS New Basic enclosures

For sealing the base opening and for cable entry.

#### Material:

Sheet steel

#### Surface finish:

Powder-coated, zinc-plated

#### Colour:

RAL 7035

#### Supply includes:

Assembly parts.

For enclosure dimensions		Packs of	Model No. CS
Width mm	Depth mm		
600	400	1 set	9785.511
600	500	1 set	9785.514
800	400	1 set	9785.512
800	500	1 set	9785.513
1200	400	1 set	2 x 9785.511
1200	500	1 set	2 x 9785.514



### Side panels, screw-fastened, sheet steel

#### for TS

- Automatic potential equalisation and higher EMC protection thanks to enclosure panel fasteners with earthing insert
- Easy positioning with the location aid
- Earthing bolt with contact surface

#### Material:

Sheet steel 1.5 mm, textured

#### Surface finish:

Dipcoat-primed, powder-coated on the outside

#### Colour:

RAL 7035

#### Protection category:

IP 55 to IEC 60 529

#### Supply includes:

Assembly parts.

#### Note:

Enclosure panel holders may optionally be fitted from the inside or outside of the enclosure.

Area available for population:

External dimension – 100 mm.

**1** Automatic potential equalisation

For enclosures		Packs of	Model No. TS
Height mm	Depth mm		
800	600	2	<b>8173.235</b>
1000	600	2	<b>8174.235</b>
1200	500	2	<b>8115.235</b>
1200	600	2	<b>8170.235</b>
1200	800	2	<b>8175.235</b>
1200	1000	2	<b>8176.235</b>
1400	500	2	<b>8145.235</b>
1400	600	2	<b>8146.235</b>
1400	800	2	<b>8148.235</b>
1600	500	2	<b>8165.235</b>
1600	600	2	<b>8166.235</b>
1600	800	2	<b>8168.235</b>
1800	400	2	<b>8184.235</b>
1800	500	2	<b>8185.235</b>
1800	600	2	<b>8186.235</b>
1800	800	2	<b>8188.235</b>
1800	1000	2	<b>8180.235</b>
2000	400	2	<b>8104.235</b>
2000	500	2	<b>8105.235</b>
2000	600	2	<b>8106.235</b>
2000	800	2	<b>8108.235</b>
2000	1000	2	<b>8100.235</b>
2200	600	2	<b>8126.235</b>
2200	800	2	<b>8128.235</b>



#### Accessories:

- Earth straps, see page 501.
- Enclosure panel fasteners, internal, see page 386, for heavy installed equipment and high dynamic pressures.

### Side panels, screw-fastened, stainless steel

#### for TS

- Automatic potential equalisation and higher EMC protection thanks to enclosure panel fasteners
- Easy positioning with the location aid
- Earthing bolt with contact surface

#### Material:

Stainless steel 1.4301 (AISI 304), 1.5 mm

#### Surface finish:

Brushed, grain 400

#### Protection category:

IP 55 to IEC 60 529

#### Supply includes:

Assembly parts.

For enclosures		Packs of	Model No. TS
Height mm	Depth mm		
1800	400	2	<b>8700.840</b>
1800	500	2	<b>8700.850</b>
2000	600	2	<b>8700.060</b>



#### Accessories:

Enclosure panel fasteners, internal, see page 386, for heavy installed equipment and high dynamic pressures.

#### Detailed drawings:

Available on the Internet.



# Walls

## Side panels



### Side panels, asymmetrical for TS

The alternative to the standard side panel for improved visual appearance in the event of back-to-back, back-to-side or corner baying. The gap (A) which occurs with standard side panels is reduced to a standard dimension (B), see technical drawing. In the case of the TS 8 corner enclosure, an asymmetrical side panel is included in the supply.

The number of additional asymmetrical side panels required depends on the chosen baying variant.

**Material:**

Sheet steel, 1.5 mm

**Colour:**

RAL 7035

**Protection category:**

IP 55 to IEC 60 529

**Supply includes:**

Assembly parts.

For enclosures		Packs of	Model No. TS
Height mm	Depth mm		
1800	400	2	<b>8184.500</b>
1800	500	2	<b>8185.500</b>
1800	600	2	<b>8186.500</b>
2000	400	2	<b>8104.500</b>
2000	500	2	<b>8105.500</b>
2000	600	2	<b>8106.500</b>
2000	800	2	<b>8108.500</b>
2200	600	2	<b>8126.500</b>



**Accessories:**

Enclosure panel fasteners, internal, see page 386, for heavy installed equipment and high dynamic pressures.

Asymmetrical side panel



Side panel



Corner baying

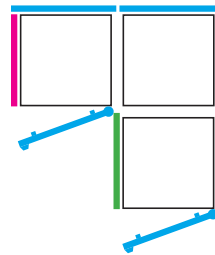

Back-to-back baying

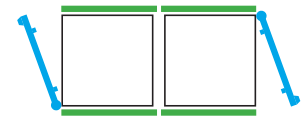

Rear panel



Door



Standard side panel

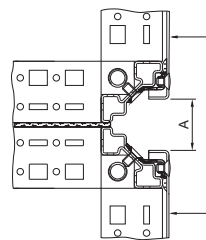

Asymmetrical side panel

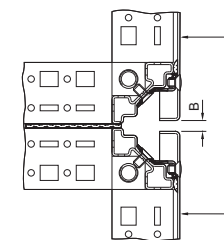

### Enclosure panel fasteners, internal

**for TS**

for additional fixing of the side or rear panel with heavy installed equipment and high dynamic pressures.

Packs of	Model No. TS
10	<b>8800.071</b>

### Hinges

for  
**TS side panel, screw-fastened, sheet steel**  
**TS side panel, asymmetrical**

The 180° opening angle allows unhindered access. May be installed optionally from the inside or outside of the enclosure: Simply replace 3 enclosure panel fasteners with hinges. Despite the hinge, the protection category of the enclosure is retained.

**Material:**  
 Die-cast zinc

**Supply includes:**  
 Assembly screws.

Design	Packs of	Model No. TS
RAL 7035	6	8800.110

**Note:**

- Side panel and door hinges may only be installed on the same enclosure section when using a 180° door hinge (see page 425).
- Please note: Red areas (side panels), hinged and unhinged, must always be opposite one another. Blue areas (doors/rear panels) must always be opposite one another. Only one surface on each vertical enclosure section may be hinged.

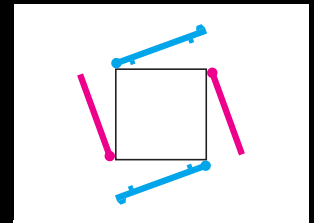
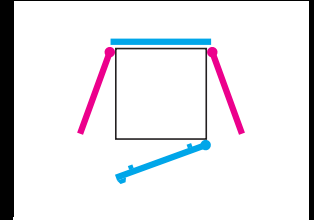

### Side panel, lockable

- for TS
- Simply locate from above
  - Lock via security lock no. 3524 E
  - Earthing bolt with contact lug.

**Material:**  
 Sheet steel, powder-coated

**Protection category:**  
 IP 20/NEMA 1 to IEC 60 529

**Supply includes:**  
 2 side panels each with 4 security locks no. 3524 E.

**Note:**  
 Side panels 1200 mm deep as divided variants, see page 388.

**+** **Accessories:**

Internal latch DK 7824.510, see page 388.

For enclosures		Colour RAL		Model No. DK
Height mm	Depth mm	7035	9005	
800	600	■	–	7824.086
1000	600	■	–	7824.106
1200	600	■	–	7824.126
1200	800	■	–	7824.128
1200	1000	■	–	7824.120
1200	1000	–	■	7816.120
1400	600	■	–	7824.146 <sup>1)</sup>
1400	800	■	–	7824.148
1600	600	■	–	7824.166
1600	800	■	–	7824.168
1800	600	■	–	7824.186
1800	800	■	–	7824.188
1800	1000	■	–	7824.180 <sup>1)</sup>
2000	600	■	–	7824.206
2000	800	■	–	7824.208
2000	1000	■	–	7824.200
2000	1000	–	■	7816.200 <sup>1)</sup>
2200	600	■	–	7824.226
2200	800	■	–	7824.228
2200	1000	■	–	7824.220

<sup>1)</sup> Extended delivery times.

# Walls

## Side panels

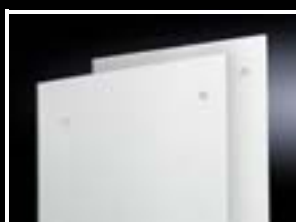

### Internal latch

#### for side panel, lockable

Additional security is achieved via the option of latching the side panel from the inside. The side panels on the frame section are screw-fastened from the inside with latching brackets.

#### Supply includes:

Assembly parts.

For enclosure system	Packs of	Model No. DK
TS	4	<b>7824.510</b>

### Side panel, plug-type, divided for DK-TS

The horizontally divided side panel offers clear advantages for storage, transportation and assembly, thanks to the reduced weight and smaller dimensions of its individual parts. The lower side panel part is inserted into the base frame and secured in the centre of the enclosure via a punched section with mounting flange. After attaching, the complete side panel is locked at the top with 2 locks.

**Material:**  
Sheet steel

**Colour:**  
RAL 7035

For enclosures		Packs of	Model No. DK
Height mm	Depth mm		
2000	1200	1	<b>7824.310</b>
2200	1200	1	<b>7824.312</b>

#### Supply includes:

- Side panel with security lock 3524 E
- Punched sections with mounting flanges
- Earth conductor
- Assembly parts

### Side panels for TE

- Simple assembly with insertion aid at the bottom and lock at the top
- Earthing bolt with contact lug

**Material:**  
Sheet steel

**Surface finish:**  
Powder-coated

**Protection category:**  
IP 20

**Supply includes:**  
Security lock 3524 E.

For enclosures		Packs of	Colour RAL		Model No. TE
Height mm	Depth mm		7035	9005	
2000	800	2	■	–	<b>7000.652</b>
2000	1000	2	■	–	<b>7000.653</b>
2000	1000	2	–	■	<b>7000.663</b>

### Primer/paint

For touching up and repairing powder-coated and wet-painted surfaces, air-drying.

	Colour RAL	Model No. SZ
Touch-up pen 12 ml	7032	<b>2436.732</b>
	7035	<b>2436.735</b>
Tin 1000 ml	7035	<b>2438.735</b>
	7022	<b>2581.000</b>
Spray can 150 ml	7032	<b>2437.000</b>
	7035	<b>2440.735</b>

## Divider panels/partitions

### Cable management panel

#### for DK-TS

The universal routing aid for network enclosures where large quantities of cables and lines are managed. Can also be used as a partition with cable management option.

By attaching to the inner level, cables may be routed inside and out, also in conjunction with a side panel.

Mounting options:

- Directly onto the inner mounting level of TS 8 enclosures
- On the outer mounting level on punched sections with mounting flanges.

#### Material:

Sheet steel

#### Surface finish:

Powder-coated

#### Colour:

RAL 7035

#### Supply includes:

Assembly parts.

For enclosures		Model No. DK
Width/depth mm	Height mm	
600	2000	<b>7824.560</b>
800	2000	<b>7824.580<sup>1)</sup></b>

<sup>1)</sup> Extended delivery times.



#### Accessories:

- Nylon loop fasteners, see page 530.
- Cable route, see page 536.
- Cable ties, see page 530.
- Cable shunting rings, see page 534.
- Cable manager, see page 533.



### Divider panel

#### for TS

For shielding individual enclosure cells. Thanks to the symmetry of the frame system, the divider panel can also be used at the rear. All-round, double fold for stability and to hold the seal. Notches in the corners and half-way up the sides permit the use of angular baying brackets and baying brackets, even with a divider panel fitted. For mounting on the outer mounting level. This leaves the inner level free for further population.

#### Material:

Sheet steel, 1.5 mm, zinc-plated

#### Protection category:

IP 54 to IEC 60 529, subject to the correct use of module plates.

#### Supply includes:

Assembly parts.

#### Note:

The divider panel may also be fitted to the rear. This allows, e.g. frequency converters for heat dissipation to be installed in a divider panel with the cooling units facing outwards and protected/finished off with a cover (see page 392).



#### Accessories:

- Cover with door, see page 392.
- Baying attachment, vertical (TS 8800.470) for enclosures with fitted divider panel, see page 398.

For enclosures		Model No. TS
Height mm	Depth mm	
1800	400	<b>8609.840</b>
1800	500	<b>8609.850</b>
1800	600	<b>8609.860</b>
2000	400	<b>8609.040</b>
2000	500	<b>8609.050</b>
2000	600	<b>8609.060</b>
2000	800	<b>8609.080</b>
2200	600	<b>8609.260</b>

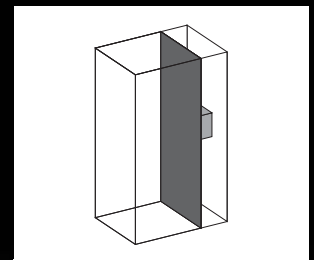
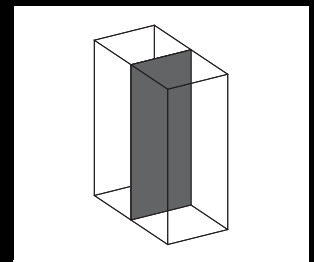
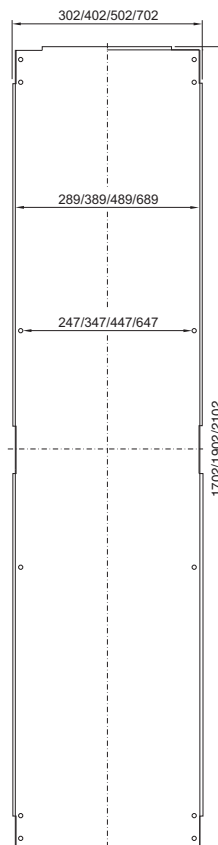

# Walls

## Divider panels/partitions



### Partition

#### for DK-TS

For rack mounting, suspended between two TS 8 enclosures.

With three Ø 40 mm holes in all 4 corner areas for the insertion of cable sections, conduits etc.

Drilled holes may be sealed with the enclosed stepped collars. For cable entry, simply cut off at a suitable level to match the required cross-section.

#### Material:

- Partition: Sheet steel
- Stepped collar: Plastic to UL 94-HB

#### Surface finish:

Partition: Zinc-plated

#### Supply includes:

12 stepped collars Ø 40 mm.

For enclosures		Model No. DK
Height mm	Depth mm	
2000	1000	<b>7831.723</b>
2000	1200	<b>7831.724</b>
2200	1200	<b>7831.726</b>

#### Note:

Use baying connector TS 8800.490.  
Not for use in conjunction with a baying seal.  
Any existing seals must be removed prior to installation.



#### Accessories:

Baying clamp TS 8800.490,  
see page 396.

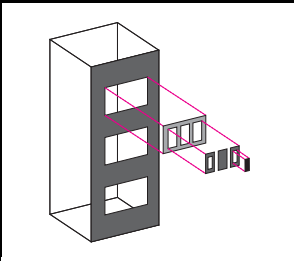

### The divider panel and module plate system

#### More options:

The cut-outs of a divider panel are individually equipped with module plates for 16-pole or 24-pole connectors, with module plates for cable entry and with solid module plates.

#### Faster assembly:

Usually only some of the total number of connector cut-outs are used. Thanks to the new divider panel technique, the cut-outs do not need to be covered individually. The solid module plate is used instead.

The benefits: Less plates, less screws, less assembly work.



### Divider panel

#### for module panels TS

With cut-outs for the installation of module plates for connectors or for cable entry, and also for the entry of busbar systems and other installed equipment. All-round, double fold for stability and to hold the seal. Thanks to the symmetry of the enclosure frame, divider panels may also be fitted at the rear, dimensions permitting.

For mounting on the outer mounting level. This leaves the inner level free for further population.

#### Material:

Sheet steel, 2 mm

#### Surface finish:

Zinc-plated

#### Supply includes:

Assembly parts and multi-tooth screws  
M5 x 12 mm for mounting the module plates.

#### Note:

Notches in the corners and half-way up the sides permit the use of angular baying brackets and baying brackets, even with a divider panel fitted.



#### Accessories:

- Module plates, see page 391.
- Cover with door, see page 392.
- Baying attachment (TS 8800.470) for enclosures with fitted divider panel, see page 398.

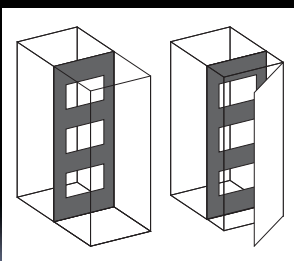
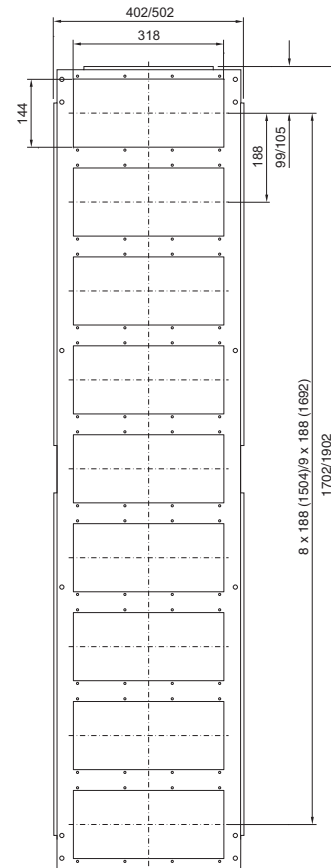

For enclosures		Number of cut-outs	Model No. TS
Height mm	Depth mm		
1800	500	9	<b>8609.100</b>
1800	600	9	<b>8609.110</b>
2000	500	10	<b>8609.120</b>
2000	600	10	<b>8609.130</b>

## Divider panels/partitions

### Module plates

**Material:**  
Sheet steel, 2 mm

**Surface finish:**  
Zinc-plated

**Supply includes:**  
Seal

Design	Cut-outs	Packs of	Model No. TS
Solid	–	1	8609.160
For 16-pole connectors	4	1	8609.150
For 24-pole connectors	4	1	8609.140
For cable entry	1	1	8609.170
For cable entry grommets	4	1	8609.190
With cable sleeve	1	1	8609.390

#### Solid

For sealing unused cut-outs. Easily machined for individual cut-outs.

#### Detailed drawings:

Available on the Internet.

#### for 16/24-pole connectors

With cut-outs to accommodate connectors. In addition to mounting on divider panels, module plates may also be attached to the 25 mm pitch pattern of the enclosure and to the rails of the TS/PS system.



#### Accessories:

- Adaptor, cover plate, see page 392.
- Connector gland for connector cut-outs, see page 522.
- Connector gland sealing frame and sealing module, see page 523.

#### For cable entry

For the entry of pre-assembled cables. Sealed, secure routing is achieved via adjustable angle brackets with inserted foam cable clamp strip. Attachment bracket, punched, for cable clamping.



#### Accessories:

Cable tie for fast assembly SZ 2597.000, see page 530.

#### For cable entry grommets

For mounting on the divider panel for module plates TS. Slide the grommets into the cut-outs, slide the clamp plate with seal down over them, and screw-fasten.



#### Also required:

- Cable entry grommets, see page 512 or
- Connector grommets, see page 512.

#### With cable sleeve

For 10 – 65 mm cable diameters. The flexible grommet adapts to the cable's bending radius.



# Walls

## Divider panels/partitions



### Adaptors

#### for connector cut-outs

For using connectors with varying numbers of poles.

#### Material:

Sheet steel

#### Surface finish:

Zinc-plated

#### Supply includes:

Seal for adaptor and mounting accessories.

For reduction	Packs of	Model No. SZ
From 24 to 16 poles	5	<b>2479.000</b>
From 24 to 10 poles	5	<b>2480.000</b>
From 24 to 6 poles	5	<b>2481.000</b>
From 16 to 10 poles	5	<b>2401.000</b>
From 16 to 6 poles	5	<b>2402.000</b>



### Cover plate

#### for connector cut-outs

For unused cut-outs.

#### Material:

Sheet steel

#### Surface finish:

Zinc-plated

#### Supply includes:

Seal and assembly parts.

For	Packs of	Model No. SZ
24-pole cut-outs	20	<b>2477.000</b>
16-pole cut-outs	20	<b>2478.000</b>



### Cover with door

#### for TS

- To protect and finish off connectors or other installed equipment.
- Optional cable entry from above or below.

#### Material:

- Cover: Sheet steel, 1.5 mm
- Door: Sheet steel, 2.0 mm

#### Colour:

RAL 7035

#### Supply includes:

- Cover
- Door with locking rod and double-bit lock insert
- 1 cover plate for top or bottom.

For enclosures		Model No. TS
Height mm	Depth mm	
2000	500	<b>8609.020</b>
2000	600	<b>8609.030</b>



#### Accessories:

- Lock inserts, version F, see page 421.
- Comfort handle, see page 415.
- 180° hinge, see page 425.



### Noise protection kit

#### for TS

Noise insulating mats for equipping or retro-fitting enclosures.

Thanks to their self-adhesive rear, the noise insulating mats are easily attached to existing surfaces. Sound is absorbed, leading to significant noise reduction. The kit is designed to reduce noise from the roof, sides and rear of an enclosure with dimensions WHD 800 x 2000 x 800 mm.

Other dimensions can be accommodated by cutting to size individually.

#### Material:

Soft foam based on melamine resin, 20 mm

#### Colour:

Pale grey

#### Supply includes:

Spacer bolts for sound insulation of the roof plate.

#### Material category:

B1 to DIN 4102

For enclosures W x H x D mm	Packs of	Model No. DK
800 x 2000 x 800	1 set	<b>7824.650</b>

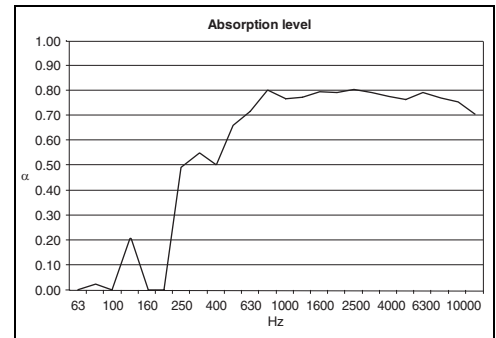

Asorption level  $\alpha$ : share of absorbed output, 1 = 100% (averaged).  
Averaged noise reduction (comparison source, 50 Hz – 20 kHz): 1 m standard distance (averaged)



## Isolator door locking

### TS isolator door cover (US version)

Including main door lock for safety locking of enclosures and bayed enclosure suites in accordance with US regulations, only in conjunction with actuator lever for master switches:

- Allen Bradley 1494 F-M1/P1/S1 and 140 U-K-FCX04
- Square D 9422 A1
- ITE Siemens Max-Flex series/FHOH (only available in the USA)
- General Electric TDA Type 1 and 2
- Moeller NZM-XSHGVR 12-NA

#### Benefits:

- In combination with
  - Operating mechanism
  - Adjacent door latch
  - Interconnecting rods
 meets the requirements of UL 508 A
- Compact design with a width of just 100 mm.
- May be mounted instead of a side panel. With this cover, all standard single-door TS 8 enclosures may be configured as isolator door enclosures. The complete installation surface of the enclosure is retained.
- May be mounted optionally on the left or right of the enclosure.
- In conjunction with the integrable TS 8 mounting plate infill, (see page 443), the mounting surface of the main enclosure can be enlarged by around 14%.

#### Material:

Sheet steel

#### Surface finish:

Powder-coated

#### Colour:

RAL 7035

#### Protection category:

IP 55 to IEC 60 529, complies with NEMA 12.

#### Supply includes:

Main door lock, cover plate and assembly parts.

Width mm	Height mm	Depth mm	Model No. TS
100	1800	400	<b>8900.840</b>
100	1800	500	<b>8900.850</b>
100	2000	500	<b>8900.050</b>
100	2000	600	<b>8900.060</b>



#### Also required:

- Operating mechanism, TS 4912.000, for enclosure with isolator door cover and additionally every fourth adjacent enclosure, see page 393.
- Adjacent door latch, TS 4911.000, TS 4911.100, for every adjacent enclosure, see page 393.
- Interconnecting rods, for every adjacent enclosure in the appropriate enclosure width, see page 393.



#### Accessories:

Mounting plate infill, see page 443.

#### Isolator door locking (US version)

- 1 Operating mechanism
- 2 Adjacent door locking (single-door)
- 3 Interconnecting rod
- 4 Connection component
- 5 Main door latch
- 6 Adjacent door locking (two-door)

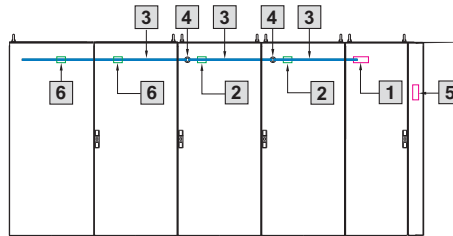

### Door latch for bayed enclosure suites

For extending the door locking of **commercially available master switches** to bayed suites TS. Adjacent door cannot be opened until the main door has been opened.

#### 1 Operating mechanism

(Fitted in the enclosure with master switch and additionally in every fourth adjacent enclosure)

#### 2 Adjacent door latch

(Installation in adjacent enclosure)

#### 3 Interconnecting rods

To extend locking from the main enclosure to the adjacent enclosures of a bayed suite. An interconnecting rod corresponding to the width of the enclosure is required for each adjacent enclosure.

	Packs of	Model No. TS
Operating mechanism	1	<b>4912.000</b>

Adjacent door locking for	Packs of	Model No. TS
single-door enclosures	1	<b>4911.000</b>
two-door enclosures	1	<b>4911.100</b>

For enclosure width mm	Packs of	Model No. TS
600	10	<b>4916.000</b>
800	10	<b>4918.000</b>
1200	10	<b>4920.000</b>



# Baying system

## Enclosure suites



### Bayable on all sides

Whether around corners, forwards, backwards, to the left or right or even upwards if required, the baying options are unlimited.

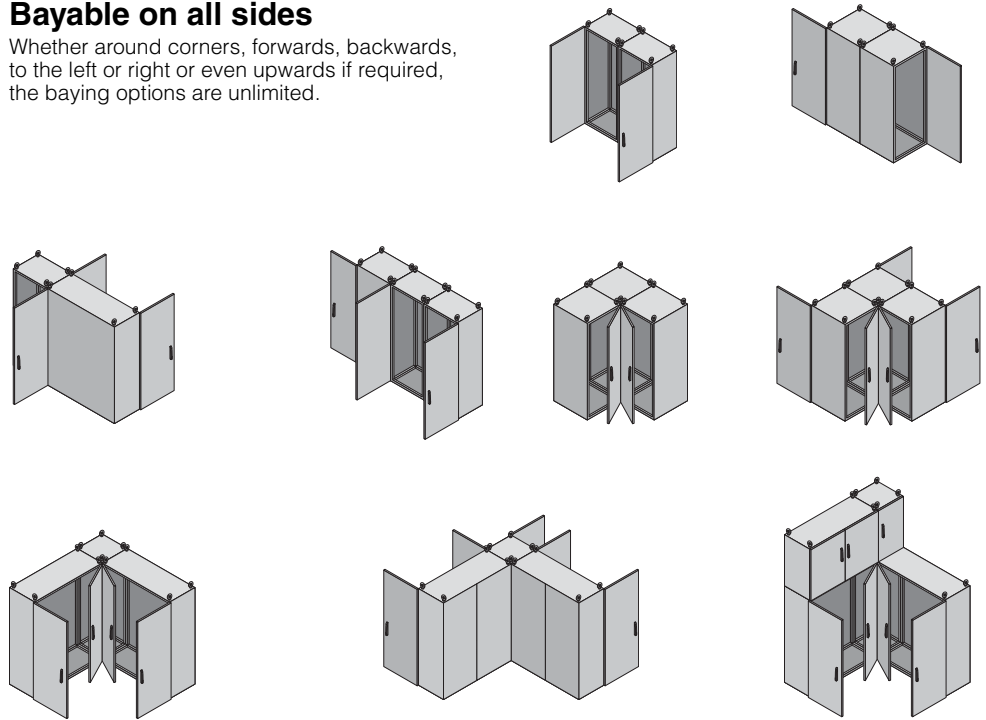

### For baying at the installation site or for provisional siting in the workshop

- 1 Quick-fit baying clamps, one-piece
- 2 Quick-fit baying clamps, three-piece
- 3 Baying clamp, horizontal
- 4 Baying clamp, vertical for TS/TS
- 5 Baying clamp, vertical for TS/PS
- 6 Baying connector, external

**Notes** on the transportation of bayed enclosures, see page 396.

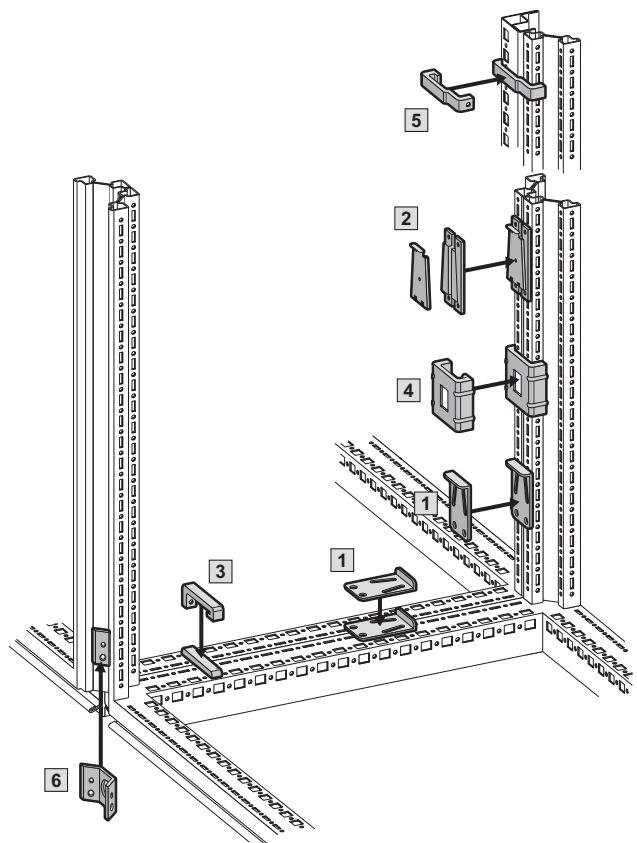

# Baying system

## Enclosure suites

### 1 Quick-fit baying clamp, one-piece

#### for TS/TS

Simply attach the screws, insert the quick-fit baying clamp, tap in with a hammer and lock.

**Material:**

Sheet steel

**Surface finish:**

Zinc-plated

**Supply includes:**

Assembly parts.

Packs of	Model No. TS
6	8800.500

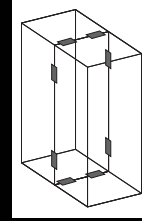

### 2 Quick-fit baying clamp, three-piece

#### for TS/TS

Simply locate, connect with the lock plate, and secure.

**Material:**

Sheet steel

**Surface finish:**

Zinc-plated

**Supply includes:**

Assembly parts.

Packs of	Model No. TS
6	8800.590

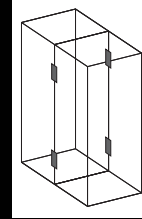

### 3 Baying clamp, horizontal

#### for TS/TS, TS/PS

For mounting on the horizontal enclosure sections.

**Material:**

Cast steel

**Surface finish:**

Zinc-plated

**Supply includes:**

Assembly parts.

Packs of	Model No. TS
4	8800.400

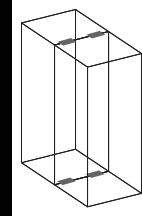

### 4 Baying clamp, vertical

#### for TS/TS

For mounting on the vertical enclosure sections.

**Material:**

Sheet steel

**Surface finish:**

Zinc-plated

**Supply includes:**

Assembly parts.

Packs of	Model No. TS
6	8800.410

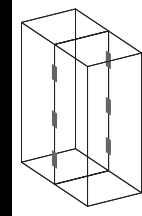

# Baying system

## Enclosure suites

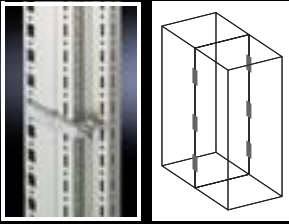

### 5 Baying clamp, vertical

#### for TS/PS

For mounting on the vertical enclosure sections.

**Material:**  
Cast steel

**Surface finish:**  
Zinc-plated

**Supply includes:**  
Assembly parts.

Packs of	Model No. TS
6	8800.420

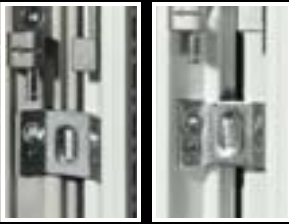

### 6 Baying connectors, external

#### for TS/TS

For mounting on the vertical enclosure sections.

Simply position on the outside and screw-fasten either from the inside or outside.

**Supply includes:**  
Assembly parts.

Material/surface finish	Packs of	Model No. TS
Sheet steel, zinc-plated	6	8800.490
Stainless steel 1.4301 (AISI 304)	6	8700.000

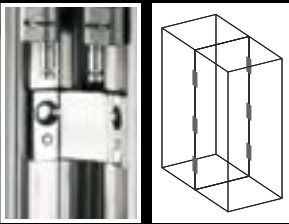

## Note on the transport of bayed enclosures

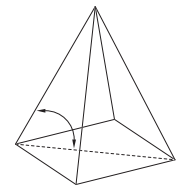
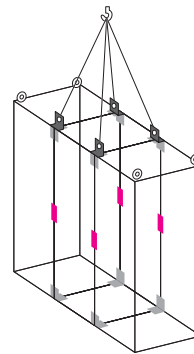
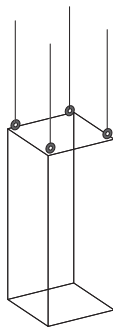
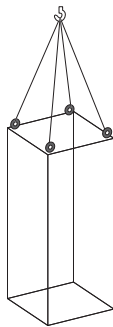

Individual enclosures may be safely transported using the eyebolts included with the supply. For symmetrical loads, the following maximum permissible loads apply:  
for 45° cable pull angle 4,800 N,  
for 60° cable pull angle 6,400 N,  
for 90° cable pull angle 13,600 N.

#### Note:

The eyebolts must be aligned in the direction of the cable pull.  
For larger baying combinations, we recommend the use of a transport base/plinth, see page 368.

For the enclosure combination with angular baying brackets, quick-fit baying clamps and combination angles shown here, the load capacity with a cable pull angle of 60° is as follows:  
for the left-hand enclosure 7,000 N,  
for the central enclosure 14,000 N,  
for the right-hand enclosure 7,000 N.

The cable pull angle between the roof plate and the cable has a significant influence on the total permissible load. The cable pull angle must not be less than 45°, and where possible, should be less than 60°.

# Baying system

## Enclosure suites

### When transporting bayed enclosures

- 7** Baying bracket for TS/TS
- 8** Baying bracket for TS/TS and TS/PS

**Note:**

- In addition, the outer baying connector (see page 396), can be used.
- When transporting large, heavy enclosure combinations by crane, we additionally recommend the use of combination angles TS 4540.000, see page 398.

**! Also required:**

For protection category IP 55:  
One connector/clamp is required half-way up the enclosure height, see page 395.  
Baying clamp, see page 395/396.

**Notes** on the transportation of bayed enclosures, see page 396.

- A**
- 1** 2 quick-fit baying clamps  
**TS 8800.500**  
(see page 395).
  - 7** 4 baying brackets  
**TS 8800.430**  
(see page 397).

- B**
- 1** 2 quick-fit baying clamps  
**TS 8800.500**  
(see page 395).
  - 7** 2 baying brackets  
**TS 8800.430**  
(see page 397).
  - 8** 4 baying brackets  
**TS 4582.500**  
(see page 398) if the angular baying brackets cannot be fitted in the foremost installation position due to installed equipment such as large swing frames.

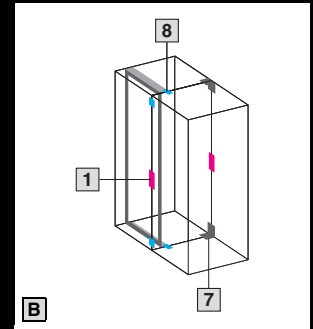
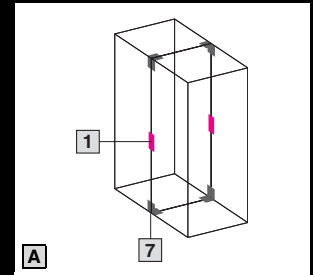
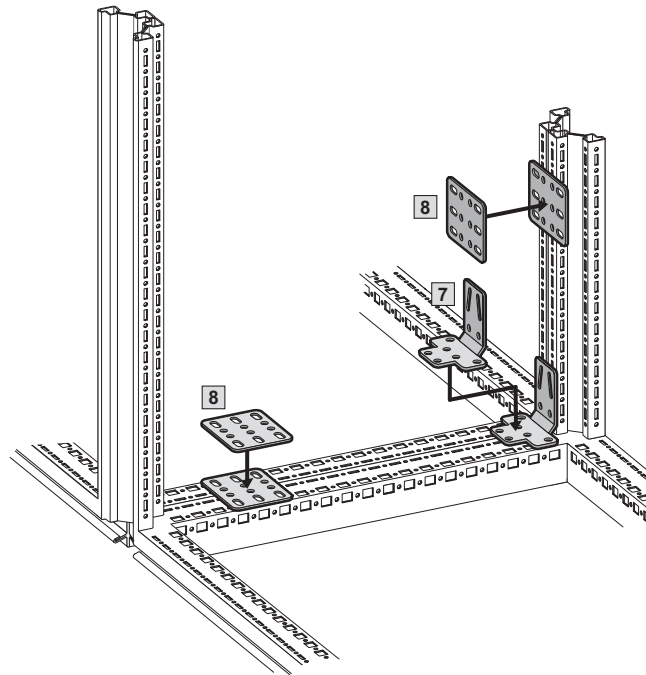

### **7** Angular baying brackets

#### for TS/TS

For a stable connection when transporting bayed enclosure suites.

Screw-fastening either

- Horizontally and vertically with 8 screws
- Horizontally with 2 screws and M8 threaded blocks, vertically with 4 screws connection.

**Material:**

Sheet steel

**Surface finish:**

Zinc-plated

**Supply includes:**

Assembly parts.

Packs of	Model No. TS
4	8800.430

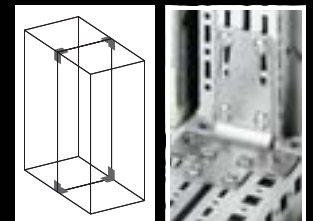

# Baying system

## Enclosure suites

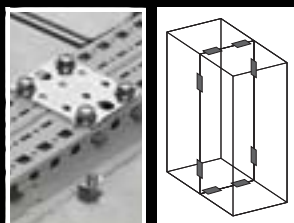

### 8 Baying brackets

#### for TS/TS and TS/PS

For additional stabilisation, or in cases where:

- Mounting plate brackets
- Swing frame
- Busbar support

prevent the installation of angular baying brackets.

**Material:**

Sheet steel

**Surface finish:**

Zinc-plated

**Supply includes:**

Assembly parts.

Packs of	Model No. TS
4	4582.500

**+ Accessories:**

For mounting on the vertical TS enclosure section: Snap-on nut M8, TS 8800.808, see page 471.



### Angular baying bracket

The alternative to baying bracket TS 4582.500 and for individual interior installations.

**Material:**

Sheet steel

**Surface finish:**

Zinc-plated

**Supply includes:**

Screws M8 x 16 mm.

Packs of	Model No. PS
4	4582.000

**! Also required:**

For mounting on:

- Horizontal TS enclosure section, captive nuts/threaded blocks M8, see page 477,
- Vertical TS enclosure section, snap-on nut M8, TS 8800.808, see page 471.



### Combination angle

For optimum distribution of tensile forces during transportation of bayed enclosures by crane.

**Material:**

Sheet steel

**Surface finish:**

Zinc-plated

**Supply includes:**

Assembly parts.

Packs of	Model No. TS
4	4580.000

**+ Accessories:**

Top baying cover, see page 399.

**Notes** on the transportation of bayed enclosures, see page 396.

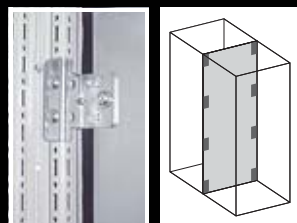

### Baying attachment, vertical

#### for TS/TS with divider panel

Only suitable for mounting in conjunction with the angle brackets of the divider panel (included with the supply).

**Material:**

Sheet steel

**Surface finish:**

Zinc-plated

**Supply includes:**

Assembly parts.

Packs of	Model No. TS
8	8800.470

**Note:**

May also be used for side or rear wall attachment/ fastening of enclosures. In such cases, additional holes must be drilled in the side or rear panel.

# Baying system

## Enclosure suites

### Baying attachment, vertical

#### for TS/TS

For baying two populated enclosures on the vertical enclosure section.

Simply locate into the vertical TS punchings, secure and connect both brackets by using the hex screws (supplied loose).

Using the fastening bolts, the enclosure is pulled into a defined end position, with a height or side offset of up to  $\pm 2$  mm.

#### Material:

Sheet steel, 3 mm

#### Surface finish:

Zinc-plated

#### Supply includes:

Assembly parts.

Packs of	Model No. TS
6	8800.670

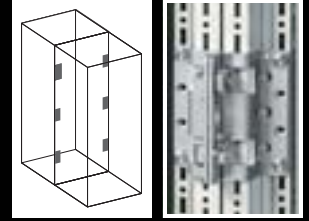

### Baying clamp, horizontal

#### for back-to-back mounting

Two-piece, for in situ assembly of enclosures with mounting plate in the rearmost installation position.

#### Material:

Sheet steel

#### Surface finish:

Zinc-plated

#### Supply includes:

Assembly parts.

Packs of	Model No. TS
4	8800.170

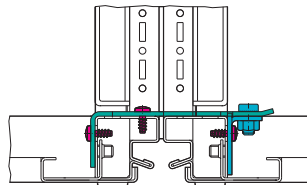
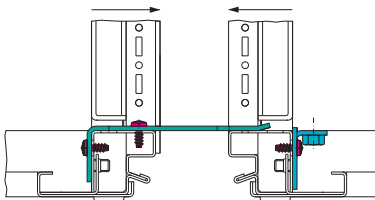
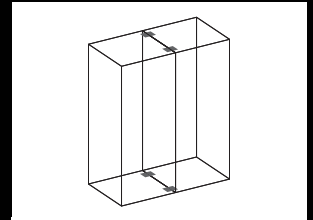

### Baying cover, top

A cover with two end caps may additionally be clipped over the seal between the two enclosures. This prevents dirt and liquid from collecting on the baying seal.

#### Material:

- Cover section: Sheet steel or stainless steel
- End caps: Plastic

#### Surface finish:

Spray-finished

#### Supply includes:

- Cover section
- 2 end caps

#### Note:

May also be fitted in the width with enclosure suites bayed back-to-back.

May also be used in conjunction with dust guard trim, see page 432.

For enclosure depth mm	Packs of	RAL 7035	Stainless steel 1.4301 (AISI 304)	Model No. TS
400	1	■	–	8800.840
500	1	■	–	8800.850
600	1	■	–	8800.860
800	1	■	–	8800.880
1000	1	■	–	8800.892
400	1	–	■	8700.140
500	1	–	■	8700.150
600	1	–	■	8700.160



# Baying system

## Enclosure suites

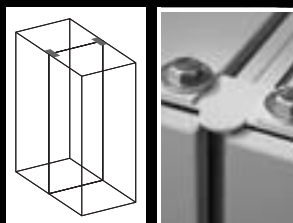

### Baying connector, external

#### for DK-TS/DK-TS with side panels

For retrospective baying of enclosures with screw-fastened or lockable side panels.

**Material:**  
Sheet steel

**Colour:**  
RAL 7035

**Supply includes:**  
Assembly parts.

Packs of	Model No. DK
4	7824.540



### Compensating panel

#### for TS

The panel is screw-fastened to the outside of the enclosure frame and serves as an infill panel when baying 2000 mm high enclosures of varying depths.

No seal between the enclosures.

**Material:**  
Sheet steel

**Colour:**  
RAL 7035

**Supply includes:**  
Assembly parts.

Depth difference mm	Model No. DK
100	7067.100 <sup>1)</sup>
200	7067.200

<sup>1)</sup> Extended delivery times.



### Baying kit

#### for TE/TE

For connecting individual enclosures into bayed suites at the sides. The enclosures are connected between the base and roof frame.

**Material:**  
Sheet steel

**Surface finish:**  
Zinc-plated

**Supply includes:**  
Assembly parts.

Packs of	Model No. TE
4	7000.640



### Baying kit

#### for KL, AE

Special screws and nuts

- For fast, simple assembly without thread-tapping.
- Compression of the seal is limited to a predefined level, to ensure a long-lasting, permanent seal between enclosures.

Seal, self-adhesive

- Comprised of bayable sealing elements and corner pieces, for individual adaptation to various enclosure sizes.

One pack is sufficient for a baying point up to H x D = 800 x 350 mm.

**Supply includes:**  
– Sealing elements  
– Assembly parts

Packs of	Model No. SZ
1 set	1199.100





# Baying system

## TS 8 corner enclosures

### TS 8 corner enclosures

The corner enclosure and the supplied components will accommodate the various baying options of the TS 8 frame on all outer surfaces. Fitted with a rear panel and an asymmetrical side panel (see page 386, mounted on the l/h side), the corner enclosure also permits the option of baying in both the width and depth. The gland plates are aligned parallel to the rear panel. In TS 8 enclosures with a square footprint, the gland plates may also be rotated through 90°. The baying system is identical to all other TS 8 enclosures.

#### Material:

Sheet steel, 1.5 mm

#### Surface finish:

- Enclosure frame, roof, rear panel, side panel: Dipcoat-primed, powder-coated on the outside, textured paint
- Gland plates: Zinc-plated

#### Colour:

RAL 7035

#### Supply includes:

- Enclosure frame
- Roof
- Rear wall (on the longest side)
- Side panel, asymmetrical
- Gland plates (divided in a longitudinal direction)

Width mm	Height mm	Depth mm	Model No. TS
400	1800	400	<b>8484.300</b>
500	1800	400	<b>8584.300</b>
600	1800	400	<b>8684.300</b>
500	1800	500	<b>8585.300</b>
600	1800	500	<b>8685.300</b>
600	1800	600	<b>8686.300</b>
400	2000	400	<b>8404.300</b>
500	2000	400	<b>8504.300</b>
600	2000	400	<b>8604.300</b>
800	2000	400	<b>8804.300</b>
500	2000	500	<b>8505.300</b>
600	2000	500	<b>8605.300</b>
800	2000	500	<b>8805.300</b>
600	2000	600	<b>8606.300</b>
800	2000	600	<b>8806.300</b>
600	2200	600	<b>8626.300</b>

Extended delivery times.



#### Accessories:

- TS base/plinth, see page 360.
- Connecting plinth trim, see page 365.



### Baying examples

#### TS 8 corner enclosures

B = Width  
T = Depth

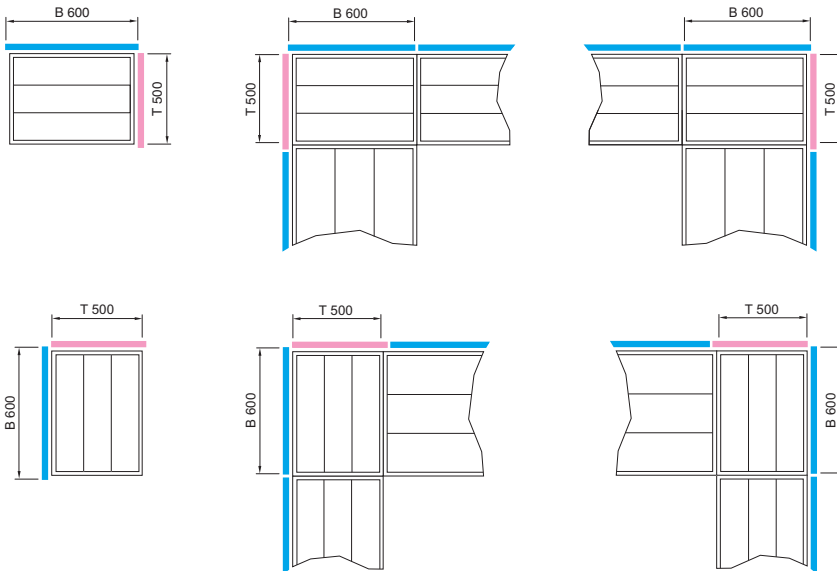

#### Note:

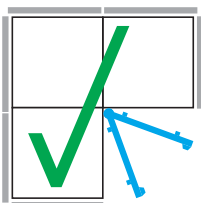

Correct

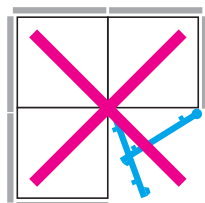

Incorrect

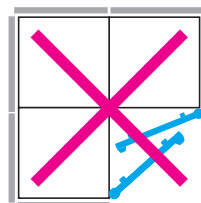

Incorrect

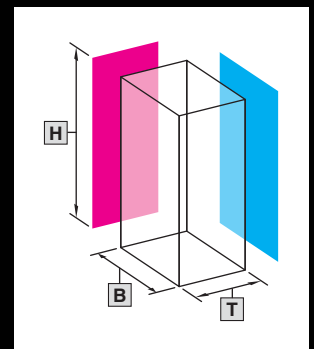

# Doors/locks

## Door variants

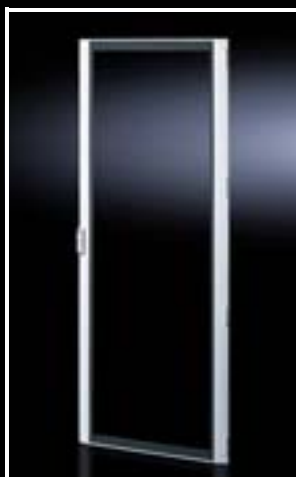

### Glazed door

#### for TS

Instead of a sheet steel door or rear panel.

#### Material:

- Front panel: Extruded aluminium section
- Corner pieces: Die-cast zinc
- Viewing window: Single-pane safety glass, 3 mm

#### Surface finish:

Powder-coated

#### Colour:

- Frame and corner pieces: RAL 7035
- Viewing window (printed mask on the inside): RAL 7015

#### Protection category:

IP 55 to IEC 60 529

#### Supply includes:

- Viewing door frame with safety glass
- Locking rod with double-bit insert
- 180° hinges (4)
- Visible area: W – 140 mm, H – 160 mm

For enclosures		Model No. TS
Width mm	Height mm	
600	1800	<b>8610.680</b>
800	1800	<b>8610.880</b>
600	2000	<b>8610.600</b>
800	2000	<b>8610.800</b>
600	2200	<b>8610.620</b>
800	2200	<b>8610.820</b>



#### Also required:

When mounting instead of the rear panel:  
Lock components for frame TS 8800.040, see page 402.



#### Accessories:

- Lock inserts, version F, see page 421.
- Comfort handle, see page 415.

### Handle adaptor

The handle adaptor compensates for the design chamfer in the door profile to enable installation of the comfort handle.

#### Material:

Plastic

#### Supply includes:

- 1 adaptor plate
- 1 extension for drive
- 2 assembly screws

#### For glazed door TS

Colour	Model No. TS
RAL 7035	<b>8611.080</b>

#### For designer door IW and PC-TS, bottom door

Colour	Model No. PC
RAL 7035	<b>8611.300</b>

### Lock components

#### for frame TS

For retrofitting a glazed door or sheet steel door in place of a rear panel.

#### Material:

Die-cast zinc

#### Supply includes:

Assembly screws.

Packs of	Model No. TS
4	<b>8800.040</b>

### Sheet steel door

#### for DK-TS

To replace existing doors. With 180° hinges and swivel handle with security lock no. 3524 E, in exchange for comfort handle.

#### Material:

Sheet steel

#### Colour:

RAL 7035

#### Protection category:

IP 55 to IEC 60 529

#### Supply includes:

Assembly parts.

For enclosures		Model No. DK
Width mm	Height mm	
600	2000	<b>7824.205</b>
800	1200	<b>7824.127</b>
800	2000	<b>7824.207</b>
600	2200	<b>7824.225</b>
800	2200	<b>7824.227</b>



#### Accessories:

- Comfort handle, see page 415.
- 180° hinge for bayed TS enclosure suites with comfort handle, see page 425.



### Sheet steel door, vented

#### for DK-TS

With 180° hinges and swivel handle with security lock no. 3524 E, in exchange for comfort handle. For optimum air throughput in network enclosures with a high proportion of active components. Slotted surface with air inlet opening > 78%.

#### Material:

Sheet steel

#### Colour:

RAL 7035

#### Supply includes:

Assembly parts.

For enclosures		Model No. DK
Width mm	Height mm	
600	1800	<b>7824.183</b>
600	2000	<b>7824.203</b>
800	2000	<b>7824.204</b>
600	2200	<b>7824.223</b>
800	2200	<b>7824.224</b>



#### Accessories:

- Comfort handle, see page 415.
- 180° hinge for bayed TS enclosure suites with comfort handle, see page 425.



### Glazed door, vented

#### for DK-TS

With 180° hinges and comfort handle with security lock no. 3524 E. For optimum air throughput in network enclosures with a low proportion of active components.

#### Material:

- Front panel: Sheet steel
- Viewing window: Single-pane safety glass, 3 mm
- Slotted surfaces (SWG-6.7 hexagon) at the sides for air inlet

#### Surface finish:

Spray-finished

#### Colour:

RAL 7035

#### Supply includes:

Assembly parts.

For enclosures		Model No. DK
Width mm	Height mm	
600	2000	<b>7824.201</b>
800	2000	<b>7824.202</b>
800	2200	<b>7824.222</b>



#### Accessories:

- 180° hinge for bayed TS enclosure suites with comfort handle, see page 425.



# Doors/locks

## Door variants



### Sheet steel door, vertically divided

#### for DK-TS

With 130° hinges and locking rod, including comfort handle for semi-cylinder with security lock no. 3524 E. Thanks to the minimal rotation radius of the individual doors, the distance between individual bayed enclosure suites may be reduced. The extensive door perforations additionally support climate control of the installed equipment. Slotted surface with air inlet opening > 78%.

#### Material:

Sheet steel

#### Protection category:

- IP 55 to IEC 60 529 (unvented)
- IP 20 to IEC 60 529 (vented)

#### Colour:

RAL 7035

#### Supply includes:

Assembly parts.

#### Vented

For enclosures		Model No. DK
Width mm	Height mm	
600	2000	<b>7824.360</b>
600	2200	<b>7824.362</b>
800	2000	<b>7824.380</b>
800	2200	<b>7824.382</b>

#### Unvented<sup>1)</sup>

For enclosures		Model No. DK
Width mm	Height mm	
600	2000	<b>7816.360</b>
600	2200	<b>7816.362</b>
800	2000	<b>7816.380</b>
800	2200	<b>7816.382</b>

<sup>1)</sup> Without tubular door frame.

Tubular door frame available on request.



#### Accessories:

180° hinge TS 8800.190, see page 425.



### Sheet steel glazed door, vertically divided

#### for TS

With underlaid viewing panel, 4-point locking rod and comfort handle for semi-cylinder with security lock 3524 E.

The divided design allows room-optimised siting of the enclosures coupled with the best possible access, thanks to a reduced distance between the individual bayed enclosure suites. Max. door opening angle, thanks to pre-integrated 180° hinges.

#### Material:

- Front panel: Sheet steel
- Viewing window: Single-pane safety glass, 3 mm

#### Surface finish:

Powder-coated

#### Colour:

RAL 7035

For enclosures		Model No. DK
Width mm	Height mm	
800	2000	<b>7824.280</b>
800	2200	<b>7824.282</b>

#### Protection category:

IP 55

#### Supply includes:

Assembly parts.

#### Note:

Height 2200 mm cannot be combined with swing frame 45 U.



### All-glass door, vertically divided

#### for DK-TS

With 180° hinges and locking rod including comfort handle for semi-cylinder with security lock no. 3524 E. Thanks to the minimal rotation radius of the individual doors, the distance between individual bayed enclosure suites may be reduced.

#### Material:

- Frame elements: Aluminium
- Viewing window: Single-pane safety glass, 5 mm

#### Colour:

- Frame elements: RAL 7035
- Viewing windows: Tinted

#### Supply includes:

Assembly parts.

For enclosures		Model No. DK
Width mm	Height mm	
800	2000	<b>7824.490</b>

#### Note:

Not to be used in conjunction with a swing frame.

## Door variants

### Lockable and adjacent door

#### for TS

For example, if two 400 mm doors instead of one 800 mm wide door are used to comply with escape routes.

#### Material:

Sheet steel

#### Surface finish:

Dipcoat-primed, powder-coated on the outside

#### Supply includes:

2 doors including hinges and lock parts.

For enclosures		Colour RAL	Model No. TS
Width mm	Height mm		
800	2000	7035	<b>8801.450</b>



#### Accessories:

Lock system, see page 415.



### Protective bars

#### for TS

As an alternative to a door, e.g. in sealed switch rooms. Prevents people from falling into the open enclosure frame. Easily removable for maintenance purposes.

For 1200 mm enclosure width; may be shortened or divided for other sizes.

#### Material:

Wood, spray-finished, RAL 3000

For enclosure width mm	Length mm	Packs of	Model No. TS
1200	1090	1	<b>8801.010</b>

Enclosure width mm	Clearance between the enclosure frame (B3) mm	Length protective bar (L) mm
400	312	290 <sup>1)</sup>
600	512	490 <sup>1)</sup>
800	712	690 <sup>1)</sup>
1000	912	890 <sup>1)</sup>
1200	1112	1090

<sup>1)</sup> The protective bar TS 8801.010 (1090 mm) will need to be shortened.

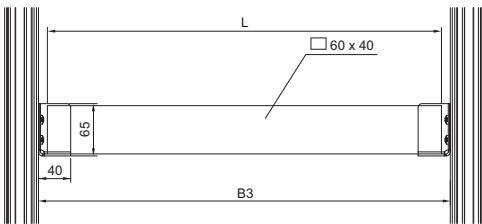

### Holder

#### for protective bars

For location into the vertical TS section. The protective bar is simply inserted.

#### Material:

Sheet steel

#### Surface finish:

Zinc-plated

#### Supply includes:

Assembly screws.

Packs of	Model No. TS
2	<b>8801.000</b>



### Variable modular climate control concept

Instead of an enclosure door in a 600 mm/800 mm/1200 mm wide and 1800 mm/2000 mm high TS enclosure, section doors with integral cooling module may be retrofitted without major assembly work.



#### Possible alternative:

Modular climate control concept, see page 248/249.



# Doors/locks

## Door variants



### Trim frame

#### for TS

To conceal the TS 8 front frame in enclosures without a door. Can be combined with large swing frames.

Possible application areas include, for example:

- Studio technology
- Electronic configuration

#### Material:

Sheet steel

#### Colour:

RAL 7035

#### Supply includes:

Assembly parts.

For enclosures		Model No. DK
Width mm	Height mm	
600	2000	<b>7824.130</b>
800	2000	<b>7824.132</b>

#### Note:

The trim frame conceals the system punchings at the sides in the inner mounting level.

The TS punched sections with mounting flange 23 x 73 mm (see page 460) may be used for installation.



### Interior door

#### with mounting frame for compact enclosure AE IP 69K, stainless steel

For the installation of control and display components. Mounting frame, depth-adjustable for a distance between the outer surface and the inside of the outer door of 35 to 85 mm (80 mm with AE 1101.110).

#### Material:

Sheet steel, 1.5 mm

#### Colour:

RAL 7035

#### Supply includes:

- Mounting frame
- Door with cam lock and screwdriver insert
- Assembly parts

For AE enclosure	W (B) mm	H mm	Model No. AE
1101.110	160	260	<b>1101.910</b>
1101.120	330	330	<b>1101.920</b>
1101.130	330	580	<b>1101.930</b>
1101.140	580	580	<b>1101.940</b>

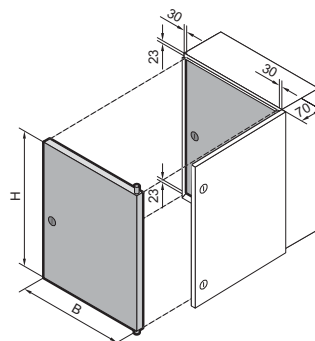

## Viewing panels/operating panels

### System window

To conceal display and operating instruments or cut-outs, and to protect against dirt and liquids as well as unauthorised access.

#### Consisting of the following 2 components:

##### 1. Base frame:

- Easily screw-fastened to the door thanks to modified dimensions (tubular door frame may be used as a drilling template).
- Readily height-adjustable.
- Stabilises the door cut-out.
- Conceals the cut edge.
- The rain canopy
  - prevents dirt from landing on the seal,
  - protects the glass from being lifted out,
  - prevents the ingress of dirt and moisture when opening the window.
- Frame section height 30 mm or 60 mm

##### 2. Viewing window:

- Made from single-pane safety glass:
  - high level of resistance to solvents and scratches,
  - anti-static,
  - reduced risk of injury if broken.
- Cam lock with double-bit insert, easily exchanged for lock inserts, type A, and semi-cylinders in the Ergoform-S lock system (not with FT 2735.500 and .560)
- Hinge with 180° opening angle, easily inserted.

#### Material:

Extruded aluminium sections with die-cast zinc corner pieces and single-pane safety glass.

#### Surface finish:

- Base frame: Powder-coated in RAL 7035
- Hinge and lock section: Natural-anodised

#### Protection category:

IP 54 to IEC 60 529

#### 30 section

To fit TS, ES with width mm	Window size, exterior, mm		Model No. FT
	W (B)	H	
600	500	270	2735.500
		370	2735.510
		470	2735.520
		570	2735.530
		670	2735.540
800	700	270	2735.560
		370	2735.570
		470	2735.580
		570	2735.590
		670	2735.250

#### 60 section

To fit TS, ES with width mm	Window size, exterior, mm		Model No. FT
	W (B)	H	
600	500	370	2736.510
		470	2736.520
		570	2736.530
		670	2736.540
800	700	670	2736.500

Standard double-bit lock insert may be exchanged for lock inserts 27 mm, type A, see page 421 and for lock system Ergoform-S (except H = 270 mm), see page 419.

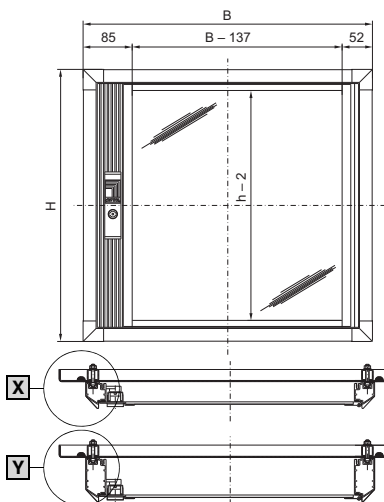

Viewing area (W (B) – 137) offset by 16.5 mm towards the hinge side.

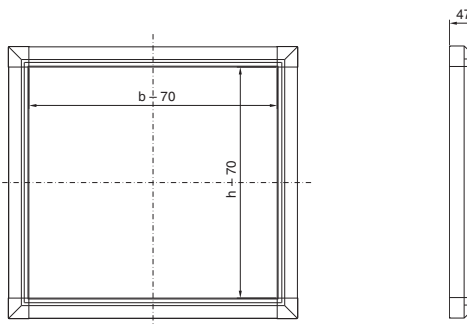

View X for profile height 30

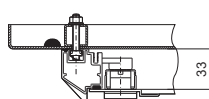

View Y for profile height 60

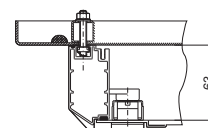

# Doors/locks

## Viewing panels/operating panels



### Viewing window

- For mounting on
- AE instead of door
  - Surfaces

**Material:**

- Front panel: Aluminium, natural-anodised.
- Glass panel: Acrylic

**Protection category:**

IP 54 to IEC 60 529

**Supply includes:**

Plastic handle with lock insert no. 3524 E.

Max. installation depth: (depth – 4 mm)

Visible area: (width – 60 mm) x (height – 60 mm)

**Note:**

Other sizes available on request.



**Depth = 34 mm**

For use as door variant with	Width mm	Height mm	Model No. FT
AE 1050.500, AE 1350.500 AE 1007.600	497	497	<b>2733.000</b>
AE 1039.500, AE 1339.500 AE 1009.600, DK 7641.000	597	377	<b>2730.000</b>
AE 1010.500, AE 1054.500 AE 1060.500, AE 1360.500 DK 7643.000	597	597	<b>2731.000</b>
AE 1012.500, AE 1076.500 AE 1376.500, DK 7645.000	597	757	<b>2732.000</b>
for 3 U subrack	597	197	<b>2734.000</b>

**Depth = 60 mm**

For use as door variant with	Width mm	Height mm	Model No. FT
AE 1050.500, AE 1350.500 AE 1007.600	497	497	<b>2763.000</b>
AE 1039.500, AE 1339.500, AE 1009.600, DK 7641.000	597	377	<b>2760.000</b>
AE 1010.500, AE 1054.500 AE 1060.500, AE 1360.500 DK 7643.000	597	597	<b>2761.000</b>
AE 1012.500, AE 1076.500 AE 1376.500, DK 7645.000	597	757	<b>2762.000</b>

Packs of	Model No. FT
2	<b>2772.000</b>



### Horizontally hinged FT stay

A gas pressurised spring holds the viewing window securely open (top or side).

When the viewing window is closed, the gas pressurised spring disappears into the frame section.



### Acrylic glazed cover

With security lock, lock no. 3524 E.

**Material:**

- Front panel: Extruded aluminium sections with die-cast corner pieces
- Glass panel: Smoked acrylic

**Protection category:**

IP 54 to IEC 60 529

**Acrylic glazed covers, 482.6 mm (19")**

U	Width mm	Height mm	Depth mm	Model No. FT
3	320	158	47.5	<b>2780.000</b>
3	534	158	47.5	<b>2781.000</b>
6	534	291.5	47.5	<b>2782.000</b>
9	534	425	47.5	<b>2796.000</b>

Max. installation depth: 43 mm

Visible area: (width – 40 mm) x (height – 20.5 mm)

**Metric acrylic glazed covers**

Width mm	Height mm	Depth mm	Model No. FT
400	200	47.5	<b>2784.000</b>
400	400	47.5	<b>2785.000</b>
500	200	47.5	<b>2786.000</b>
500	400	47.5	<b>2787.000</b>
600	200	47.5	<b>2788.000</b>
600	400	47.5	<b>2789.000</b>

Max. installation depth: 43 mm

Visible area: (width – 40 mm) x (height – 20.5 mm)



## Viewing panels/operating panels

### Viewing window

#### Stainless steel

Fitted as standard with internal 130° hinges and all-round seal.

The double-bit lock insert may be exchanged for 27 mm lock inserts, type A, and Ergoform-S handle SZ 2452.000.

#### Material:

Stainless steel 1.4301 (AISI 304)  
Single-pane safety glass

#### Protection category:

IP 54 to IEC 60 529

#### Supply includes:

Assembly parts.

Width mm	Height mm	Depth mm	Model No. FT
522	600	38	2793.560



#### Accessories:

- Lock inserts, 27 mm, version A, see page 421.
- Ergoform-S handle SZ 2452.000, see page 419.

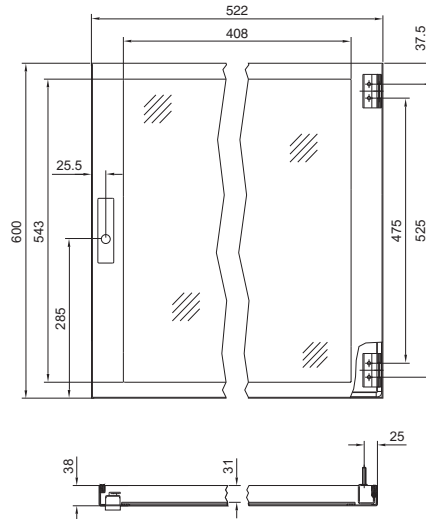

### Monitor frame

#### For door width 600 and 800 mm

For covering a door cut-out, for all standard monitors up to 482.6 mm (19").

#### Protection category:

IP 54 to IEC 60 529

#### Supply includes:

Security glass pane.

Dimensions	Width mm	Height mm	Model No. SZ
External dimensions	470	430	2305.000
Viewing area	375	325	
Cut-out required	415	375	



### Identification strips

For individual field identifiers on the door, including transparent cover and assembly parts.

For labels:

Width: Enclosure width – 150 mm

Height: 29 mm

Thickness: 0.75 mm.

#### Colour:

RAL 7033

For enclosure width mm	Model No. SZ
600	2403.000
800	2404.000



# Doors/locks

## Viewing panels/operating panels



### Operating panel

For mounting on:

- AE instead of door
- Surfaces

Frame construction with corner connectors on the inside, 3 mm aluminium plate secured from the inside and sealed against the frame

**Material:**

Aluminium, natural-anodised

**Protection category:**

IP 54 to IEC 60 529

**Supply includes:**

Aluminium frame, display panel, hinges, brackets.

For use as door variant for AE	Width mm	Height mm	Depth mm	Model No. FT
1001.600 1002.500 1002.600 1032.500 1035.500	197	297	34	<b>2740.000<sup>1)</sup></b>
1004.600 1011.600 1030.500 1031.500	377	297	34	<b>2741.000</b>
1006.500 1006.600 1380.500	377	377	34	<b>2742.000</b>
1008.600 1038.500 1338.500	377	597	34	<b>2743.000</b>
1007.600 1013.600 1050.500 1350.500	497	497	34	<b>2745.000</b>
1009.600 1039.500 1339.500	597	377	34	<b>2744.000</b>
1010.500 1010.600 1060.500 1360.500	597	597	34	<b>2746.000</b>

<sup>1)</sup> With AE, only for use on the rear panel

Area available for population:  
(width – 70 mm) x (height – 70 mm)

Dimensions of aluminium plate:  
(width – 54 mm) x (height – 54 mm)



**Accessories:**

Cam lock FT 2749.000,  
see page 410.



### Cam lock

May be retrofitted to the operating area or enclosure panel of operating panels. Standard double-bit lock insert may be exchanged for type C lock inserts and type C plastic handle.

Packs of	Model No. FT
1	<b>2749.000</b>



**Accessories:**

- Lock inserts, type C, see page 421.
- Plastic handle, type C, see page 420.



### Viewing window

**for operating panel**

For the protection of display and control components. With a build height of max. 35 mm.

**Material:**

Frame: Aluminium, natural-anodised  
Glazed panel: Smoked acrylic

**Supply includes:**

Lock insert no. 3524 E.

For operating panel	Model No. FT
FT 2741.000	<b>2791.000</b>
FT 2742.000	<b>2792.000</b>

### Compact enclosures, sheet steel

		Enclosure series								
		EB	BG	AE, wall-mounted enclosures AE		CM	KS		EL 3-part	
Condition		-	With cam	With cam	With 3-point lock	-	With cam	With 3-point lock	3 – 15 U	18 – 21 U
	from page	37	39	44	46	48	50	51	60	60

#### Handle systems for enclosures

Handle systems for enclosures										
<b>Comfort handle</b>										
For lock inserts	415	-	-	-	-	-	-	-	-	■
For padlock and lock inserts	415	-	-	-	-	-	-	-	-	■
With security lock insert E1	415	-	-	-	-	-	-	-	-	■
For semi-cylinder	415	-	-	-	-	-	-	-	-	■
Prepared for ASSA lock system	415	-	-	-	-	-	-	-	-	■
<b>Mini-comfort handle (from AE enclosure height 380 mm, from AE enclosure width 300 mm)</b>										
For lock inserts	418	-	-	■	-	-	-	-	■	-
For semi-cylinder	418	-	-	■	-	-	-	-	■	-
<b>Ergoform-S handle</b>										
Standard	419	-	-	-	■	-	-	-	-	-
Special with lock insert, lock E1	419	-	-	-	■	-	-	-	-	-
Specially prepared for ASSA lock system	419	-	-	-	■	-	-	-	-	-
Standard for KS plastic enclosures	419	-	-	-	-	-	-	■	-	-
<b>Folding lever handle</b>										
For lock inserts	416	-	-	-	-	■	-	-	-	-
For padlock and lock inserts	416	-	-	-	-	■	-	-	-	-
With security lock insert E1	416	-	-	-	-	■	-	-	-	-
<b>Semi-cylinder lock</b>										
For AE	422	-	-	■	-	-	-	-	-	-
<b>Plastic handles</b>										
Version B	420	■	■	■	-	-	-	-	-	-
Version E	420	-	-	-	-	-	■	-	-	-
<b>T handles</b>										
Version B	420	■	■	■	-	-	-	-	-	-
<b>Lock inserts for enclosures</b>										
<b>Lock inserts</b>										
Version A	421	■	■	■	■	-	-	-	-	-
Version E	421	-	-	-	-	-	■	■	-	-
Version F	421	-	-	-	-	■	-	-	■	■
<b>Lock cylinder inserts</b>										
Version B	422	■	■	■	-	-	-	-	-	-

Lock inserts for handle systems				
Semi-cylinder		Lock inserts		
Lock and push-button inserts	DIN 18 252	Version A	Version F	Lock and push-button inserts
416	416	421	421	416

-	-	-	■	■
-	-	-	■	■
-	-	-	-	-
■	■	-	-	-
-	-	-	-	-
-	-	-	■	■
■	■	-	-	-
-	-	-	-	-
-	-	-	-	-
-	■	-	-	-

# Doors/locks

## Allocation of lock systems

### Large enclosures, sheet steel

Condition	from page	Enclosure series				
		TS 8	PC enclosure TS 8		DK-TS	TE 7000
		70	Door	For keyboard drawer or fold-out tray	80	85

#### Handle systems for enclosures

Comfort handle						
For lock inserts	415	■	■	-	■	-
For padlock and lock inserts	415	■	■	-	■	-
For semi-cylinder	415	■	■	-	■	-
With security lock insert E1	415	■	■	-	■	-
Prepared for ASSA lock system	415	■	■	-	■	-
Security handle with code	417	■	■ <sup>1)</sup>	-	■ <sup>1)</sup>	-
Ergoform-S handle						
Standard	419	-	-	-	-	■
Security handle with code	417	-	-	-	-	■
Special with lock insert, lock E1	419	-	-	-	-	■
Special, prepared for ASSA lock system	419	-	-	-	-	■
Lock inserts for enclosures						
Lock inserts						
Version A	421	-	-	■	-	-
Version F	421	■	■	-	-	-

<sup>1)</sup> Only suitable for use with rear door

Lock inserts for handle systems				
Semi-cylinder		Lock inserts		
Lock and push-button inserts	DIN 18 252	Version A	Version F	Lock and push-button inserts
416	416	421	421	416

-	-	-	■	■
-	-	-	■	■
■	■	-	-	-
-	-	-	-	-
-	-	-	-	-
■	■	-	-	-
■	■	■	-	-
■	■	-	-	-
-	-	-	-	-
-	-	-	-	-



## Rittal Switzerland

RITTAL AG  
 Ringstrasse 1 · CH-5432 Neuenhof  
 Phone: +41 (0) 56 416 06 00  
 Fax: +41 (0) 56 416 06 66  
 E-mail: rittal@rittal.ch · www.rittal.ch

### Console systems and industrial workstation, sheet steel

		Enclosure series						
		TopConsole TP		One-piece console TP		Universal consoler TP	IW	IW enclosure for tower PC
Condition	from page	Desk section and console	Pedestal	Console cover	Console door			
		101	101	106	106	107	110	109

#### Handle systems for enclosures

Handle system	from page	Desk section and console	Pedestal	Console cover	Console door	Universal consoler TP	IW	IW enclosure for tower PC
<b>Comfort handle</b>								
For lock inserts	415	-	-	-	-	-	■	-
For padlock and lock inserts	415	-	-	-	-	-	■	-
For semi-cylinder	415	-	-	-	-	-	■	-
With security lock insert E1	415	-	-	-	-	-	■	-
Prepared for ASSA lock system	415	-	-	-	-	-	■	-
Security handle with code	417	-	-	-	-	-	■	-

#### Ergoform-S handle

Standard	419	-	■	-	■	■	-	-
Special with lock insert, lock E1	419	-	■	-	■	■	-	-
Special, prepared for ASSA lock system	419	-	■	-	■	■	-	-

#### T handles

Version B	420	■	-	■	-	-	-	-
-----------	-----	---	---	---	---	---	---	---

#### Lock inserts for enclosures

Lock insert	from page	Desk section and console	Pedestal	Console cover	Console door	Universal consoler TP	IW	IW enclosure for tower PC
<b>Lock inserts</b>								
Version A	421	■	■	■	■	■	-	-
Version D	421	-	-	-	-	-	-	■
Version F	421	-	-	-	-	-	■	-
<b>Lock cylinder inserts</b>								
Version B	422	-	-	-	-	-	■	-

Lock inserts for handle systems				
Semi-cylinder		Lock inserts		
Lock and push-button inserts	DIN 18 252	Version A	Version F	Lock and push-button inserts
416	416	421	421	416

-	-	-	■	■
-	-	-	■	■
■	■	-	-	-
-	-	-	-	-
-	-	-	-	-
■	■	-	-	-
■	■	■	-	-
-	-	-	-	-
-	-	-	-	-



## Rittal Hungary

RITTAL Kereskedelmi Kft.  
 1044 Budapest, Ipari Park u. 1.  
 Phone: +36 (1) 399 8000  
 Fax: +36 (1) 399 8009  
 E-mail: rittal@rittal.hu · www.rittal.hu

# Doors/locks

## Allocation of lock systems

### Enclosures and cases, stainless steel

Condition	Enclosure series						
	AE		One-piece console AP		TS 8	PC	
	With cam	With 3-point lock	Console cover	Console door			
Page	162/163	164	170	170	172	171	

#### Handle systems for enclosures

Comfort handle							
For lock inserts	415	-	-	-	-	■	-
For padlock and lock inserts	415	-	-	-	-	■	-
For semi-cylinder	415	-	-	-	-	■	-
With security lock insert E1	415	-	-	-	-	■	-
Prepared for ASSA lock system	415	-	-	-	-	■	-
Ergoform-S handle							
Standard	419	-	■	-	■	-	■
Special with lock insert, lock E1	419	-	■	-	■	-	■
Special, prepared for ASSA lock system	419	-	■	-	■	-	■
Plastic handles							
Version C	420	■ <sup>1)</sup>	-	■	-	-	-
T handles							
Version C	420	■ <sup>1)</sup>	-	■	-	-	-
Semi-cylinder lock							
for AE	422	■ <sup>2)</sup>	-	-	-	-	-
Lock inserts for enclosures							
Lock inserts							
Version A	421	-	■	-	-	-	■
Version C	421	■	-	■	-	-	-
Version F	421	-	-	-	-	■	-
Lock cylinder inserts							
Version C	422	■	-	■	-	-	-

<sup>1)</sup> Not with AE 1018.600.

<sup>2)</sup> Not with enclosures from stainless steel 1.4401 (AISI 316L) and use of cam lock SZ 2304.000.

Lock inserts for handle systems				
Semi-cylinder		Lock inserts		
Lock and push-button inserts	DIN 18 252	Version A	Version F	Lock and push-button inserts
416	416	421	421	416

-	-	-	■	■
-	-	-	■	■
■	■	-	-	-
-	-	-	-	-
-	-	-	-	-
■	■	■	-	-
-	-	-	-	-
-	-	-	-	-
-	-	-	-	-
-	-	-	-	-
-	■	-	-	-



## Rittal Japan

RITTAL K.K.  
 Sales HQ.  
 Shin-Yokohama AK Bldg 2F  
 3-23-3, Shin-Yokohama, Kohoku-ku  
 Kanagawa 222-0033  
 Phone: 0120-998-631 / +81 (45) 478-6801  
 Fax: 0120-998-632 / +81 (45) 478-6880  
 E-mail: [contact@rittal.co.jp](mailto:contact@rittal.co.jp) • [www.rittal.co.jp](http://www.rittal.co.jp)

### Rittal comfort handle

for TS, DK-TS, PC, IW

As the handle does not take up any swing space, due to its folding mechanism, the door surface area may be maximised for installed equipment.

**Material:**

Die-cast zinc

**Surface finish:**

Powder-coated



**Also required:**

Handle adaptor for mounting on a

- Glazed door TS
  - Bottom door PC-TS
  - Designer door IW
- see page 402.



	For lock inserts	For padlock and lock inserts	With lock insert, lock E1 <sup>1)</sup>	For semi-cylinder <sup>2)</sup>	Prepared for ASSA lock system
	<b>Model No. TS</b>				
RAL 7032	<b>8611.010</b>	<b>8611.030</b>	<b>8611.040</b>	<b>8611.060</b>	<b>8611.050</b>
RAL 7035	<b>8611.020</b>	<b>8611.290</b>	<b>8611.045</b>	<b>8611.070</b>	<b>8611.280</b>
RAL 8019	<b>8611.250</b>	<b>8611.260</b>	–	<b>8611.270</b>	–
RAL 9005	<b>8611.350</b>	–	–	<b>8611.360</b>	–
Matt nickel-plated	<b>8611.330</b>	–	–	<b>8611.340</b>	–
<b>Lock inserts, type F</b>					
7 mm square	8611.100	8611.100	–	–	–
8 mm square	8611.110	8611.110	–	–	–
7 mm triangular	8611.120	8611.120	–	–	–
8 mm triangular	8611.130	8611.130	–	–	–
Screwdriver	8611.140	8611.140	–	–	–
Daimler insert	8611.150	8611.150	–	–	–
3 mm double-bit	8611.160	8611.160	–	–	–
Fiat	8611.170	8611.170	–	–	–
6.5 mm triangular (CNOMO)	8611.220	8611.220	–	–	–
<b>Lock and push-button inserts</b>					
Security lock insert no. 3524 E <sup>3)</sup>	8611.180	8611.180	–	2467.000	–
Push-button insert	8611.190	8611.190	–	2468.000	–
Push-button and lock insert <sup>3)</sup>	8611.200 <sup>4)</sup>	8611.200 <sup>4)</sup>	–	2469.000 <sup>5)</sup>	–
<b>Semi-cylinder</b>					
to DIN 18 252 <sup>6)</sup>	–	–	–	9785.040	–
	–	–	–	9785.042 <sup>7)</sup>	–

<sup>1)</sup> Only for use with VW, Audi, SEAT, SkodaAuto. Supplied without key.

Other VW locks available on request.

<sup>2)</sup> Comfort handle for lock cylinder KESO/KABA with Model No. TS 8611.240 available on request.

<sup>3)</sup> With 2 keys.

<sup>4)</sup> Lock no. 12321, no other lock is possible.

<sup>5)</sup> Lock no. 2123, no other lock is possible.

<sup>6)</sup> With 3 keys for each lock insert.

<sup>7)</sup> Packs of 2. Simultaneous locking within the same pack, no simultaneous locking for different packs.



# Doors/locks

## Lock systems



### Lock inserts

For installation in comfort handle, mini-comfort handle, Ergoform-S standard, folding lever handle

Installation in			
	Lock and push-button inserts		Semi-cylinder
	Comfort handle <sup>6)</sup> , mini-comfort handle <sup>6)</sup>	Comfort handle <sup>7)</sup> , mini-comfort handle <sup>7)</sup> , Ergoform-S standard, folding lever handle CM	Comfort handle, mini-comfort handle, Ergoform-S standard, folding lever handle for CM
	Model No. TS	Model No. SZ	Model No. CS
Security lock insert no. 3524 E <sup>1)</sup>	8611.180	2467.000	–
Push-button insert	8611.190	2468.000	–
Push-button and lock insert <sup>1)</sup>	8611.200 <sup>2)</sup>	2469.000 <sup>3)</sup>	–
to DIN 18 252 <sup>4)</sup>	–	–	9785.040
	–	–	9785.042 <sup>5)</sup>

<sup>1)</sup> With 2 keys. <sup>2)</sup> Lock no. 12321, no other lock is possible.

<sup>3)</sup> Lock no. 2123, no other lock is possible. <sup>4)</sup> With 3 keys for each lock insert.

<sup>5)</sup> Packs of 2. Simultaneous locking within the same pack, no simultaneous locking for different packs.

<sup>6)</sup> For lock inserts. <sup>7)</sup> For semi-cylinder.



### Folding lever handle

for CM



As the handle does not take up any swing space, due to its folding mechanism, the door surface area may be maximised for installed equipment.

#### Colour:

- Enclosure: Similar to RAL 9005
- Handle: Similar to RAL 9006

#### Size:

- Length: 242 mm (with inserted trim panel)
- Width: 50 mm
- Depth: 17.5 mm

			
	For lock inserts	For padlock and lock inserts	With lock insert, lock E1 <sup>1)</sup>
	Model No. CM		
	5001.060	5001.062	5001.061

#### Lock inserts, type F

7 mm square	8611.100	8611.100	–
8 mm square	8611.110	8611.110	–
7 mm triangular	8611.120	8611.120	–
8 mm triangular	8611.130	8611.130	–
Screwdriver	8611.140	8611.140	–
Daimler insert	8611.150	8611.150	–
3 mm double-bit	8611.160	8611.160	–
Fiat	8611.170	8611.170	–
6.5 mm triangular (CNOMO)	8611.220	8611.220	–

#### Lock and push-button inserts

Security lock insert no. 3524 E <sup>2)</sup>	2467.000	2467.000	–
Push-button insert	2468.000	2468.000	–
Push-button and lock insert <sup>2)</sup>	2469.000 <sup>3)</sup>	2469.000 <sup>3)</sup>	–

#### Semi-cylinder

to DIN 18 252 <sup>4)</sup>	9785.040	9785.040	–
	9785.042 <sup>5)</sup>	9785.042 <sup>5)</sup>	–

<sup>1)</sup> Only for use with VW, Audi, SEAT, SkodaAuto. Supplied without key.

Other VW locks available on request.

<sup>2)</sup> With 2 keys.

<sup>3)</sup> Lock no. 2123; no other lock is possible.

<sup>4)</sup> With 3 keys for each lock insert.

<sup>5)</sup> Packs of 2. Simultaneous locking within the same pack, no simultaneous locking for different packs.



### Security handle

#### with code

Flexible access opportunities with

- individual 3-digit code without key
- or
- with the master key function via an additional semi-cylinder of 40 or 45 mm to DIN 18 252, irrespective of the code.

Design with	Model No. DK
Comfort handle for TS	7200.800
Ergoform-S handle for TE	7200.810

#### + Accessories:

- SZ lock and push-button inserts, see page 416.
- Semi-cylinder, see page 416.



### Adjacent door latch

#### for TS

For optimum operation of the adjacent door from the outside if the handle on the inside is difficult to access due to swing frames or 482.6 mm (19") installed equipment. Retrospective conversion of the adjacent door is easily achieved using the supplied drilling template. The handle on the inside is no longer required.

#### Colour:

RAL 7035

#### Supply includes:

Assembly parts.

Packs of	Model No. TS
1	8611.370

#### + Accessories:

Standard double-bit lock insert may be exchanged for 27 mm lock inserts, version A, see page 421.



### Swivel handle

#### for sheet steel door DK-TS

With lock insert, lock no. 3524 E.

The use of semi-cylinders is not supported.

Length: 150 mm.

#### Note:

The swivel handle cannot be used in conjunction with 180° hinges (TS 7824.520).

Design	Model No. DK
RAL 7035	7829.300

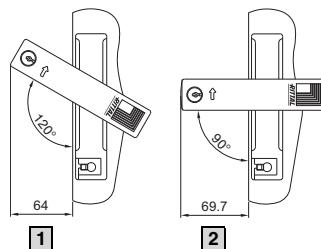

- 1 Position for door opening
- 2 Max. projection of the upper handle part



# Doors/locks

## Lock systems

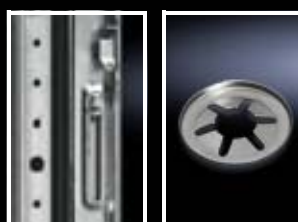
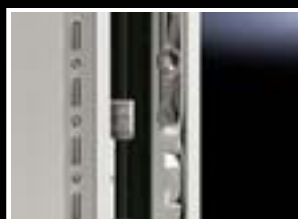
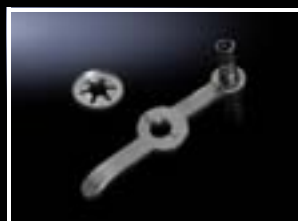

### Locking bar latch to CNOMO<sup>1)</sup>

To fit all locking bars in TS doors and glazed doors with standard lock or comfort handle.

The latch prevents the locking bars from moving when the door is open.

For mounting on the bolt of the bar guide.

<sup>1)</sup> CNOMO is a specification by the French automobile industry. For safety reasons, it must not be possible to lock the handle whilst the door is open.

Packs of	Model No. TS
10	8611.210



**Also required:**

for CNOMO<sup>1)</sup>  
Lock inserts, version F, 6.5 mm triangular insert TS 8611.220, see page 421.

### Spring washer

Upon dismantling the TS locking rods, the spring washers cannot be reused.

**Material:**  
Spring steel

**Surface finish:**  
Zinc-plated

	Packs of	Model No. TS
Spring washer	100	8800.070

### Mini-comfort handle

for AE with cam, EL 3-part

Prepared for the installation of lock inserts and for the installation of commercially available 40 or 45 mm semi-cylinders, and of lock and push-button inserts.

**Material:**  
Die-cast zinc

**Colour:**  
RAL 7035

	For lock inserts		For semi-cylinder	
	<b>Model No. DK</b>			
Fro enclosure system	EL	AE	EL	AE
	<b>7705.110</b>	<b>2537.010</b>	<b>7705.120</b>	<b>2537.000</b>
<b>Lock inserts, type F</b>				
7 mm square	8611.100	8611.100	–	–
8 mm square	8611.110	8611.110	–	–
7 mm triangular	8611.120	8611.120	–	–
8 mm triangular	8611.130	8611.130	–	–
Screwdriver	8611.140	8611.140	–	–
Daimler insert	8611.150	8611.150	–	–
3 mm double-bit	8611.160	8611.160	–	–
Fiat	8611.170	8611.170	–	–
6.5 mm triangular (CNOMO)	8611.220	8611.220	–	–
<b>Lock and push-button inserts</b>				
Security lock insert no. 3524 E <sup>1)</sup>	8611.180	8611.180	2467.000	2467.000
Push-button insert	8611.190	8611.190	2468.000	2468.000
Push-button and lock insert <sup>1)</sup>	8611.200 <sup>2)</sup>	8611.200 <sup>2)</sup>	2469.000 <sup>3)</sup>	2469.000 <sup>3)</sup>
<b>Semi-cylinder</b>				
to DIN 18 252 <sup>4)</sup>	–	–	9785.040	9785.040
	–	–	9785.042 <sup>5)</sup>	9785.042 <sup>5)</sup>

<sup>1)</sup> With 2 keys.

<sup>2)</sup> Lock no. 12321; no other lock is possible.

<sup>3)</sup> Lock no. 2123; no other lock is possible.

<sup>4)</sup> With 3 keys for each lock insert.

<sup>5)</sup> Packs of 2. Simultaneous locking within the same pack, no simultaneous locking for different packs.

### Ergoform-S lock system

The unlocked handle folds down forwards, and the lock is opened by swivelling.





**Material:**

Die-cast zinc

**Surface finish:**

Powder-coated



				
	Standard	Standard for KS plastic enclosures	Special with lock insert E1 <sup>1)</sup>	Specially prepared for ASSA lock system
	Model No. SZ	Model No. KS	Model No. SZ	
RAL 7032 with brown handle	<b>2450.000</b>	–	–	–
RAL 7035 with brown handle	<b>2450.010</b>	–	<b>2456.500</b>	–
Brown	<b>2451.000</b>	–	–	<b>2453.000</b>
Matt nickel-plated	<b>2452.000</b>	–	–	–
RAL 7032	<b>2454.000</b>	–	–	–
RAL 7035	<b>2435.000</b>	<b>1490.010</b>	–	–
RAL 7032 with brown handle and bracket	<b>2455.000</b>	–	–	–
RAL 7035 with brown handle and bracket	<b>2455.010</b>	–	–	–
<b>Lock inserts, version A</b>				
7 mm square	2460.000	2460.000	–	–
8 mm square	2461.000	2461.000	–	–
7 mm triangular	2462.000	2462.000	–	–
8 mm triangular	2463.000	2463.000	–	–
Screwdriver	2464.000	2464.000	–	–
Daimler insert	2465.000	2465.000	–	–
3 mm double-bit	2466.000	2466.000	–	–
Fiat	2307.000	2307.000	–	–
6.5 mm triangular (CNOMO)	2460.650	2460.650	–	–
<b>Lock and push-button inserts</b>				
Security lock insert no. 3524 E <sup>2)</sup>	2467.000	2467.000	–	–
Push-button insert	2468.000	2468.000	–	–
Push-button and lock insert <sup>2)</sup>	2469.000 <sup>3)</sup>	2469.000 <sup>3)</sup>	–	–
<b>Semi-cylinder</b>				
to DIN 18 252 <sup>4)</sup>	9785.040	9785.040	–	–
	9785.042 <sup>5)</sup>	9785.042 <sup>5)</sup>	–	–

<sup>1)</sup> Only for use with VW, Audi, SEAT, SkodaAuto. Supplied without key. Other lock systems available on request.

<sup>2)</sup> With 2 keys.

<sup>3)</sup> Lock no. 2123; no other lock is possible.

<sup>4)</sup> With 3 keys for each lock insert.

<sup>5)</sup> Packs of 2. Simultaneous locking within the same pack, no simultaneous locking for different packs.

# Doors/locks

## Lock systems



### Plastic handles

With or without lock cylinder insert.

**Supply includes:**

Assembly parts and seals.

Design	B		C		E		G
	With lock cylinder insert, lock no. 3524 E <sup>1)</sup>	Without lock cylinder insert	With lock cylinder insert, lock no. 3524 E <sup>1)</sup>	Without lock cylinder insert	With lock cylinder insert, lock no. 3524 E <sup>1)</sup>	Without lock cylinder insert	With lock cylinder insert, lock no. 3524 E <sup>1)</sup>
	<b>Model No. SZ</b>				<b>Model No. KS</b>		<b>Model No. SZ</b>
RAL 9011	<b>2576.000</b>	<b>2533.000</b>	<b>2485.000</b>	<b>2485.100</b>	–	–	<b>2599.000</b>
RAL 7030	<b>2439.000</b>	–	–	–	–	–	–
RAL 8019	–	–	–	–	<b>1484.000</b>	<b>1484.001</b>	–

<sup>1)</sup>With 2 keys



### T handles

With or without lock cylinder insert.

**Supply includes:**







Seal

Design	B		C	
	With lock cylinder insert <sup>1)</sup>	Without lock cylinder insert	With lock cylinder insert <sup>1)</sup>	Without lock cylinder insert
	<b>Model No. SZ</b>			
	<b>2575.000<sup>2)</sup></b>	<b>2572.000</b>	<b>2535.000<sup>2)</sup></b>	<b>2536.000</b>

<sup>1)</sup>With 2 keys

<sup>2)</sup>Lock no. 3524 E

### Cam locks

						
	With double-bit insert	With lock cylinder insert <sup>3)</sup>	With double-bit insert	With lock cylinder insert <sup>3)</sup>	With lock insert, lock E1 <sup>1)</sup> RAL 7035	With double-bit insert
Material: Enclosure	Die-cast zinc, nickel-plated		Fibreglass-reinforced polyamide			Made entirely from stainless steel 1.4404 (AISI 316L)
<b>Model No. SZ</b>						
	<b>2520.000</b>	<b>2530.000</b>	<b>2420.000</b>	<b>2430.000</b>	<b>2540.500</b>	<b>2304.000</b>

#### Lock inserts

7 mm square	2523.000	–	2460.000	–	–	–
8 mm square	2526.000	–	2461.000	–	–	–
7 mm triangular	2527.000	–	2462.000	–	–	–
8 mm triangular	2528.000	–	2463.000	–	–	–
Screwdriver	–	–	2464.000	–	–	–
Daimler insert	2522.000	–	2465.000	–	–	–
3 mm double-bit	2483.000	–	2466.000	–	–	–
Fiat	–	–	2307.000	–	–	–
6.5 mm triangular (CNOMO)	–	–	2460.650	–	–	–

#### Lock cylinder inserts





With lock no. 3524 E <sup>2)</sup>	–	–	2571.000	–	–	–
------------------------------------	---	---	----------	---	---	---

<sup>1)</sup> Only for use with VW, Audi, SEAT, SkodaAuto. Supplied without key.  
Other lock systems available on request.

<sup>2)</sup> With 2 keys

<sup>3)</sup> Lock no. 3524 E

### Lock inserts

Design	A	C	D	E	F
					
Material	Die-cast zinc	Die-cast zinc	Die-cast zinc	Plastic	Die-cast zinc
Length	27 mm	41 mm	47 mm		
	<b>Model No. SZ</b>			<b>Model No. KS</b>	<b>Model No. TS</b>
7 mm square	<b>2460.000</b>	<b>2523.000</b>	–	<b>1487.000</b>	<b>8611.100</b>
8 mm square	<b>2461.000</b>	<b>2526.000</b>	–	<b>1488.000</b>	<b>8611.110</b>
7 mm triangular	<b>2462.000</b>	<b>2527.000</b>	–	<b>1485.000</b>	<b>8611.120</b>
8 mm triangular	<b>2463.000</b>	<b>2528.000</b>	–	<b>1486.000</b>	<b>8611.130</b>
Screwdriver	<b>2464.000</b>	–	–	<b>1489.000</b>	<b>8611.140</b>
Daimler insert	<b>2465.000</b>	<b>2522.000</b>	–	–	<b>8611.150</b>
3 mm double-bit	<b>2466.000</b>	<b>2483.000</b>	<b>2484.000</b>	<b>1492.000</b>	<b>8611.160</b>
Fiat	<b>2307.000</b>	–	–	–	<b>8611.170</b>
6.5 mm triangular (CNOMO)	<b>2460.650</b>	–	–	–	<b>8611.220</b>





# Doors/locks

## Lock systems



### Lock cylinder inserts

Design	B	C
		
	With lock no. 3524 E <sup>1)</sup>	With lock no. 3524 E <sup>1)</sup>
Material	Die-cast zinc	Die-cast zinc
	<b>Model No. SZ</b>	<b>Model No. SZ</b>
	<b>2571.000</b>	<b>2525.000</b>

<sup>1)</sup> With 2 keys



### Semi-cylinder lock

#### for compact enclosures AE

For retro-fitting to single-door enclosures with cam lock.

The cover plate is locked by semi-cylinders with a total length of 40/45 mm (to DIN 18 252).

An additional cover protects the cylinder against dirt. The protection category of the enclosure is not impaired.

Supplied without semi-cylinder.

#### Material:

Die-cast zinc

Design	Model No. SZ
RAL 7035	<b>2534.100</b>
Nickel-plated (matt)	<b>2534.500</b>

#### Accessories:

Semi-cylinder, see page 416.

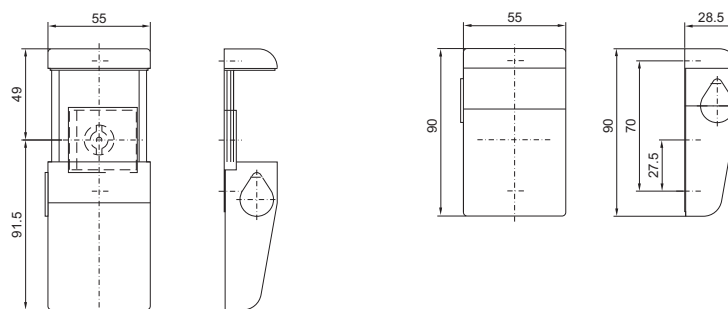

### Lock cover

#### For padlocks or multiple locks

For retrospective mounting on all compact enclosures AE, of sheet steel and with cam lock.

#### Material:

Die-cast zinc

#### Surface finish:

Nickel-plated

Packs of	Model No. SZ
1	<b>2493.000</b>

### Multiple lock

#### for 6 cam locks

The ideal solution in cases where individual access for several persons is required for maintenance and repair purposes.

**Material:**

Sheet steel

**Surface finish:**

Zinc-plated

Packs of	Model No. SZ
2	2493.500



### Lock cover

#### prepared for lead seal

For all enclosure types with Rittal-specific locks, such as AE and EB.

**Material:**

Polyamide

**Colour:**

RAL 7035

Packs of	Model No. SZ
2	2476.000



### Security lock

Fitted to doors, to protect against contact with live electrical equipment whilst the master switch is ON.

**Function:**

- Locks the door when the main switch is ON.
- Mains power (voltage) is only enabled whilst the door is closed.
- Monitoring of the lock magnet via an additional closing contact.

**Supply includes:**

- Lock
- Actuator
- Angle bracket
- Assembly parts

Connection voltage for lock magnet	Model No. SZ
230 V AC 11 VA	2416.000
24 V DC 8 W	2418.000
120 V AC 8 VA	2419.000



**! Also required:**

For twin-door enclosures (for the overlapping door, to indicate "enclosure door closed"), Rittal door-operated switch SZ 4127.010, see page 496.





# Doors/locks

## Lock systems



### Enclosure keys

For lock inserts (one double-bit key is supplied with every enclosure).

				
	Model No. SZ/QB		Model No. SZ	
	–	–	2549.000	2549.500 <sup>2)3)</sup>
Double-bit key no. 5	2531.000	–	■	■
Security key no. 3524 E	–	2532.000 <sup>1)</sup>	–	–
7 mm triangular	2545.000	–	–	■
8 mm triangular	2546.000	–	■	■
7 mm square	2547.000	–	–	■
8 mm square	2548.000	–	■	■
For HD locks	2549.600	–	–	–
Daimler key	2521.000	–	–	–
Fiat key	2308.000	–	–	–
Lock 12321	–	7526.050 <sup>1)</sup>	–	–

<sup>1)</sup> Packs of 2

<sup>2)</sup> With bit adaptor and reversible bit for multi-tooth size 25 and Phillips-head (Ph 2)

<sup>3)</sup> Bit for HD lock insert (Model No. HD 2549.510), see page 156.



### Quick-release fastener

#### for QuickBox

The quick-release fastener is ideal for use in inaccessible areas. To facilitate locking, the quick-release fastener is screw-fastened to the mounting bracket at the front. This enables the QuickBox to be locked even when the fasteners of the sides are opened, allowing the enclosure cover to be attached and removed easily.

#### Material:

Sheet steel

#### Surface finish:

Spray-finished

#### Colour:

RAL 7035

#### Supply includes:

2 mounting brackets, mounting material and quick-release fasteners.

Packs of	Model No. QB
2	7502.220



### 130°/180° hinges

**Supply includes:**  
Assembly parts

**! Also required:**

<sup>1)</sup> Lock components for frame TS 8800.040, see page 402.

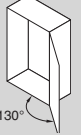
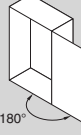
Enclosure type	Door variant	Material	Colour	Packs of	 	
					Model No.	
ES 5000	Sheet steel door	Die-cast zinc	–	6	<b>4190.000</b>	–
TS 8	Sheet steel door	Die-cast zinc	–	4	<b>8800.020<sup>1)</sup></b>	–
TS 8	Sheet steel door	Die-cast zinc	RAL 7035	4	–	<b>8800.190</b>
			RAL 7032		–	<b>8800.030</b>
			RAL 8019		–	<b>8800.230</b>
			RAL 9005		–	<b>8800.950</b>
			Matt nickel-plated		–	<b>8701.180</b>
TS 8	Doors with high dynamic loads, door installations up to 900 N	Precision casting/ die-cast zinc	RAL 7035	4	–	<b>8800.710</b>
TS 8 bayed enclosure suites with comfort handle	Sheet steel door	Die-cast zinc	RAL 7035	4	–	<b>7824.520</b>
	Glazed door	Die-cast zinc	RAL 7035			<b>7824.525<sup>2)</sup></b>
	Sheet steel door	Die-cast zinc	RAL 9005			<b>7824.522</b>
ES 5000, TP universal console, TP pedestals, TE 7000	Standard door	Aluminium	Powder-coated in RAL 8019	6	–	<b>4189.000</b>
ES 5000	Standard door	Stainless steel 1.4301 (AISI 304)	–	6	–	<b>4156.000</b>
AE	Standard door	Die-cast zinc	–	2	–	<b>2449.000</b>
CM	Standard door	Die-cast zinc	RAL 9011/9006	3	–	<b>5001.000</b>

<sup>2)</sup> Max. 140°

### Hinge pin remover

For safe and easy removal of hinge pins.

For enclosure	Model No. SM
AE/CM	<b>2432.000</b>

### Cover hinge

for KL

The cover hinge is simply screwed to the enclosure protection channel and to the edge fold.

**Supply includes:**  
Assembly parts.

Material	Packs of	Model No. KL
Die-cast zinc	6	<b>1592.000</b>
Stainless steel 1.4404 (AISI 316L)	2	<b>1592.010</b>

### Cover retainer

for KL

The cover retainer is easily fitted without drilling, and allows the covers to be opened upwards, even when the terminal box below is bayed.

Packs of	Model No. KL
3 pairs	<b>1591.000</b>

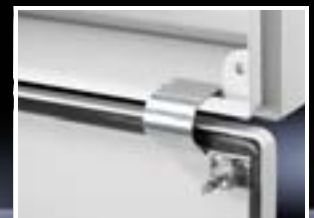

# Doors/locks

## Door, internal

### Support strips

For attachment of

- Cable ducts
- Cable conduit holders
- Contact hazard protection covers
- Equipment installed on the door
- Cable clamping and attachment

4.5 mm diameter hole on a 25 mm DIN pitch pattern.

#### Material:

Sheet steel

#### Surface finish:

Zinc-plated

#### Supply includes:

Packs of 20 (screws included).



#### Accessories:

Screws and self-tapping screws M5, see page 478.

#### For TS, CM, ES, TP

For door width mm	Length mm	Model No. SZ
400	290	4594.000
500	390	4309.000
600	490	4596.000
800	690	4598.000
900	790	4579.000
1000	890	4599.000

#### For AE

For enclosures AE	Model No. SZ
1018.600 <sup>2)</sup> , 1019.500 <sup>2)</sup> 1050.500 <sup>1)</sup> , 1057.500 1100.500, 1110.500 1114.500 <sup>1)</sup> , 1130.500 1213.500 <sup>1)</sup> , 1350.500 <sup>1)</sup>	2325.000
1009.600 <sup>2)</sup> , 1376.500 1012.500 <sup>2)</sup> , 1039.500 1054.500, 1058.500 1060.500, 1076.500 1090.500, 1260.500 <sup>1)</sup> 1339.500, 1360.500	2326.000
1014.500 <sup>2)</sup> , 1073.500 1077.500	2327.000
1016.500 <sup>2)</sup> , 1017.500 <sup>2)</sup> 1055.500, 1180.500 1280.500 <sup>1)</sup>	2328.000

<sup>1)</sup> For these AE models, the support strips should be cut to length at the knockout.

<sup>2)</sup> Only in conjunction with perforated mounting strips (see page 427).

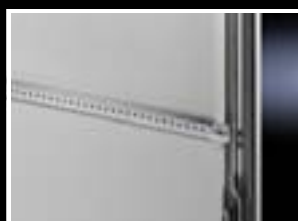

### Spacers

The universal assembly component for all cases where a distance from the mounting level is required. With self-tapping thread for diameter 4.5 mm. The following components may be attached to the rear using 5.5 x 13 mm screws:

- Top-hat/cross rails
- Contact hazard protection covers
- Master switch trim panels
- Cable clamp rails, etc.

#### Material:

Hexagonal steel (SW8)

#### Surface finish:

Zinc-plated



#### Accessories:

Screws 5.5 x 13 mm, see page 478.

Length mm	Packs of	Model No. TS
25	12	2311.225
50	12	2311.250

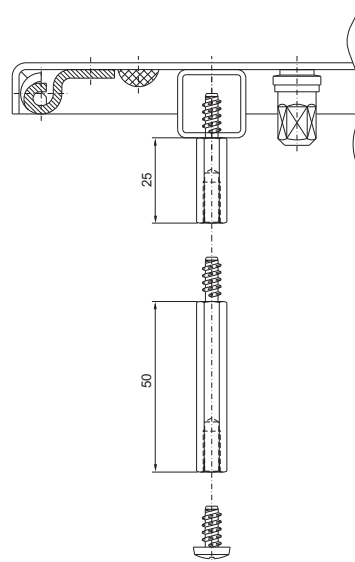

### Perforated mounting strip

for AE stainless steel, TP universal console<sup>1)</sup>

For vertical mounting on the threaded bolts of the door, for attaching

- Support strips for AE, see page 426.
- Door stay SZ 2519.000, see page 429.

3.7 mm diameter hole on a 25 mm DIN pitch pattern.

**Material:**

Sheet steel

**Surface finish:**

Zinc-plated

**Supply includes:**

Packs of 20 (nuts and serrated washers included).

To match AE	Length mm	Model No. SZ
1005.500, 1005.600, 1006.500, 1006.600, 1009.600	318	<b>2310.038<sup>1)</sup></b>
1012.600, 1014.600	698	<b>2310.076</b>
1016.600, 1018.600	938	<b>2310.100</b>
1017.600, 1019.500, 1019.600	1138	<b>2310.120</b>

<sup>1)</sup> For door at top



**Accessories:**

Screws, see page 478.



### Utility lectern

For programming units etc. Prepared for mounting on the tubular door frame of TS, CM, ES, PC or on any sufficiently large surface.

When required for servicing, it folds down quickly with a maximum support area, and after use is stowed between the tubular door frames in a space-saving design.

Load capacity: max. 30 kg.

**Material:**

Sheet steel

**Colour:**

RAL 7035

Support area		For door width mm	Model No. TS
Width mm	Depth mm		
413	400	600	<b>4638.600</b>
613	400	800	<b>4638.800</b>



### Wiring plan lectern

Holds wiring plans during fault finding and maintenance work.

The wiring plan lecterns can be bayed according to the door width.

For mounting on the tubular door frame.

**Material:**

- Utility lectern: Polypropylene
- Mounting bracket: Die-cast zinc

**Colour:**

Similar to RAL 7035

**Supply includes:**

- Wiring plan lectern (width 210 mm)
- Assembly parts

For enclosures		Packs of	Model No. TS
TS, CM, ES, PC, TP		1	<b>4120.000</b>

For door width mm	Required/possible number of wiring plan lecterns	
	min.	max.
400	1	1
500	1	1
600	2	2
800	2	3
1000	3	3



### CD/disk box

For fixing to all flat, clean surfaces with double-sided adhesive tape.

**Capacity:**

Max. 10 CDs/DVDs or 18 (3 1/2") disks.

**Material:**

Polyamide

**Colour:**

RAL 7033

Packs of	Model No. SZ
1	<b>2446.000</b>



# Doors/locks

## Door, internal



### Plastic wiring plan pockets for AE

For installation options, refer to table

- B = Screw-fastened to the perforated door strip on both sides
- E = Screw-fastened on one side, other side stuck with adhesive or stuck entirely with adhesive

### Supply includes:

- 2 holders with double-sided adhesive tape
- Acrylic glazed pane
- Assembly parts

### Note:

The acrylic glazed pane may be shortened to any required size for shorter doors.

Model No. SZ	2514.500	2514.600	2514.800
Usable width mm	340	415	615
Usable depth mm	18	18	18
Height of acrylic glazed pane mm	167	167	167

### Installation options:

For Model No. AE	Width mm			
1050.500	500	B	–	–
1054.500	600	E	E	–
1055.500	800	E	E	E
1057.500	500	B	–	–
1058.500	600	E	E	–
1060.500	600	E	E	–
1073.500	760	E	E	–
1076.500	600	E	E	–
1077.500	760	E	E	–
1090.500	600	E	E	–
1100.500	1000	B	–	–
1110.500	1000	B	–	–
1114.500	1000	B <sup>1)</sup>	–	–
1130.500	1000	B	–	–
1180.500	800	E	E	E
1213.500	1000	B <sup>1)</sup>	–	–
1260.500	600	E	B	–
1280.500	800	E	E	B
1350.500	500	B	–	–
1360.500	600	E	E	–
1376.500	600	E	E	–

<sup>1)</sup> Prepared for mounting on the l/h side door; for mounting on the r/h side door, the acrylic glazed pane can be shortened.



### Plastic wiring plan pockets

For affixing to the inside surfaces of doors.

### Material:

Polystyrene with self-adhesive fastening strips.

### Colour:

Similar to RAL 7035

For format	Clearance opening mm			Model No. SZ
	B	H	D	
A3 landscape	438	286	45	2513.000
A4 portrait	228	254	17	2514.000
A5 landscape	228	174	17	2515.000

### Wiring plan pockets with transparent pouch

With welded-on transparent pouch and self-adhesive backing.

For format	Model No. SZ
DIN A4	2510.000
DIN A3	2512.000

### Wiring plan pockets of sheet steel

for TS, CM, ES, PC, TP pedestal

For fastening to tubular door frames at any height.

**Colour:**

RAL 7035

**Supply includes:**

Assembly screws.

**D = 90 mm**

To fit door width mm	Clearance opening mm		Model No. TS
	W	H	
400	255	210	<b>4114.000</b>
500	355	210	<b>4115.000</b>
600	455	210	<b>4116.000</b>
800	655	210	<b>4118.000</b>
900	755	210	<b>4123.000</b>
1000	855	210	<b>4124.000</b>

**D = 35 mm**

To fit door width mm	Clearance opening mm		Model No. TS
	W	H	
500	355	260	<b>4115.500</b>
600	455	260	<b>4116.500</b>
800	655	260	<b>4118.500</b>



### Door stay

To secure the door in the open position.

For	Assembly	Packs of	Model No.
TS, ES, PC, TP universal console	Bottom	5	<b>4583.000</b>
AP one-piece console	Top	5	<b>2518.000</b>
CM, TP	Top	2	<b>2519.200</b>
AE (except AE 1032.500 and AE 1035.500) and all AE stainless steel enclosures <sup>1)</sup>	Top	5	<b>2519.000</b>
AE IP 69K	Top	1	<b>1101.800</b>

<sup>1)</sup> With AE stainless steel, only in conjunction with perforated mounting strips, see page 427.



### Door stay for escape routes

TS sheet steel/stainless steel doors with tubular door frames

In case of an emergency, conventional door stays can block the escape route. The stay is actuated automatically in the event of pressure, releasing the door in both directions. In conjunction with 180° hinges, this ensures that no escape routes are blocked by locked doors in the event of an emergency.

**Supply includes:**

Assembly parts.

Packs of	Model No. TS
1	<b>4583.500</b>

#### + Accessories:

180° hinge, see page 425.

#### 180° hinge

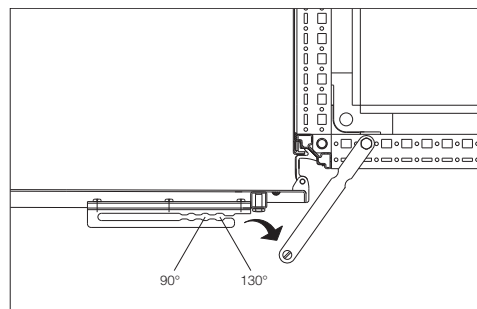

# Doors/locks

## Door, internal



### Ride-up roller

for TS, ES, PC

Lifts the door with heavy installed equipment (e.g. cooling unit) as a closing aid. For attaching to the tubular door frame.

Packs of	Model No. TS
10	4538.000



### Transport and mounting handle

for doors TS, ES

For safe installation and removal of the door and during relocation in the workshop. The matching hinge pin removal tool for 130° hinges is pre-integrated, and supplied loose for 180° hinges.

Packs of	Model No. SM
1	2415.100



### Document clip, magnetic

For simple attachment of installation documentation as a reminder or for flexible accommodation of a wide range of documents, measurement records, test reports etc. May be attached to any magnet compatible surface via a permanent magnet.

Packs of	Model No. DK
2	7950.200

#### Material:

- Plastic: Transparent
- Handle pieces: Black

#### Supply includes:

- 2 mounting clamps
- Permanent magnet

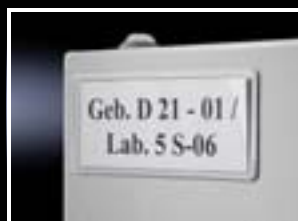

### Alternate frame, magnetic

For individual marking or labelling of the existing network infrastructure.

The magnetic surface facilitates flexible mounting on all magnet compatible surfaces. Adhesive strips are supplied for non-magnetic compatible surfaces.

The maximum size of the labels is 130 x 50 mm.

Packs of	Model No. DK
10	7950.150

#### Material:

Plastic

#### Supply includes:

- Alternate frame, magnetic
- Labels
- Double-sided adhesive tape

### Rain canopies

#### for AE, CM

Reliable protection for outdoor siting – with water run-off to the rear. Easily retro-fitted.

#### Supply includes:

Assembly parts.



#### Accessories:

- Condensate discharge, see page 384.
- Pressure relief stopper, see page 384.
- Wall mounting brackets SZ 2503.010 and SZ 2508.010 may be used, see page 439.

#### Note:

For outdoor siting, we generally recommend a rain canopy above the enclosure or the gap between the door or screw-fastened rear panel and the enclosure, in order to protect against water and UV radiation.

The tests of IP protection categories for water protection (2nd code number to EN 60 529) cannot be compared with an enclosure sited outdoors or under similar conditions.

Upon request, rain canopies of sheet steel, stainless steel or aluminium can also be produced for other enclosures.

#### for AE, sheet steel version

#### Material:

Sheet steel

#### Surface finish:

Powder-coated, textured paint

#### Colour:

RAL 7035

For		Model No. SZ
Enclosure width mm	Enclosure depth mm	
380	210	<b>2501.500</b>
600	210	<b>2502.500</b>
600	350	<b>2511.500</b>



#### for AE, stainless steel version

#### Material:

Stainless steel 1.4301 (AISI 304)

#### Surface finish:

Brushed, grain 240

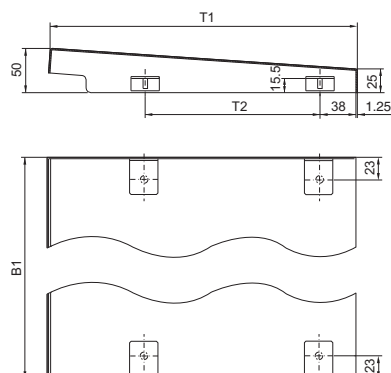

For		Model No. SZ
Enclosure width mm	Enclosure depth mm	
200	155	<b>2470.000</b>
300	210	<b>2361.000</b>
380	155	<b>2471.000</b>
380	210	<b>2472.000</b>
500	210	<b>2362.000</b>
600	210	<b>2473.000</b>
760	300	<b>2474.000</b>
800	300	<b>2475.000</b>
1000	300	<b>2363.000</b>



#### Possible alternative:

Compact enclosures Hygienic Design, see page 153.

B1 = Enclosure width + 11 mm

T1 = Enclosure depth + 25 mm

T2 = Enclosure depth – 90 mm, from enclosure width 600 mm: Enclosure depth – 115 mm

#### for CM, sheet steel version

#### Benefits:

- Mounting via the two holes in the top of the CM
- At the front, with integrated ventilation holes at the top

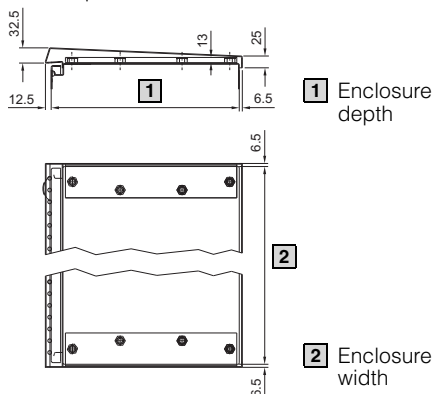

Width mm	Depth mm	Model No. CM
600	400	<b>5001.310</b>
800	400	<b>5001.330</b>
1000	400	<b>5001.350</b>
1200	400	<b>5001.360</b>

#### Material:

Sheet steel

#### Surface finish:

Powder-coated, textured paint

#### Colour:

RAL 7035

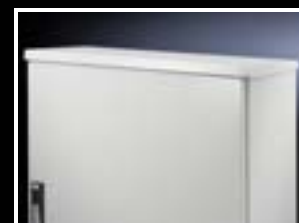

# Roof/wall mounting

## Roof

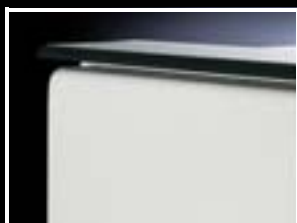

### Dust guard trim

#### for AE, CM, EB, KL and BG

To protect against deposits on the upper edge of the door and between the enclosure and the door/lid. Cut the door protection strip to length according to the enclosure width. Drill the enclosure and mount the strip using the adhesive strips and screws.

#### Material:

Plastic, UV-resistant

#### Colour:

Similar to RAL 7024

For enclosure	Length mm	A mm	Model No. SZ
AE	1200	25	<b>2426.500</b>
CM		20	
KL, EB, BG		20.5	

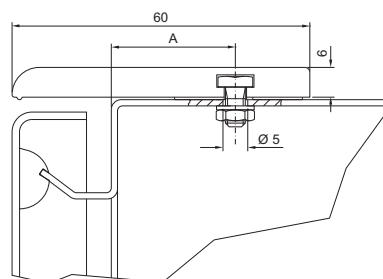

### Dust guard trim

#### for TS, ES

To protect against dust deposits on the upper edge of the door and between the door and upper horizontal enclosure section. The dust guard trim provides space for texts or company logos.

#### Colour:

RAL 7035

#### Supply includes:

Clear plastic strip for text labels (height 29.5 mm).

Length mm	Model No. SZ
600	<b>2424.100</b>
800	<b>2425.100</b>
1000	<b>2427.100</b>
1200	<b>2426.100</b>

#### Note:

Also suitable for use in conjunction with top baying cover, see page 399.



# Roof/wall mounting

## Roof

### Top mounting module

#### for TS

As a cable chamber for cable infeed from above or for power distribution with busbar systems across bayed enclosures. The TS cover plate is used as standard to finish off at the top. The enclosure height is increased by 200 mm with the top mounting module fitted.

The top baying cover cannot be fitted. Installation accessories for top and bottom, see diagram and explanations below.

#### Material:

Sheet steel, 1.5 mm

#### Surface finish:

Spray-finished, textured paint

#### Colour:

RAL 7035

#### Protection category:

IP 55 to IEC 60 529, compliant with NEMA 12 (in conjunction with side panel for top mounting module, see page 433).

For enclosures		Model No. TS
Width (B) mm	Depth mm	
600	600	<b>8801.735</b>
800	600	<b>8801.745</b>
1000	600	<b>8801.755</b>
1200	600	<b>8801.765</b>

#### Supply includes:

- 1 frame module
- 2 trim panels (front and rear)
- 8 retainers with automatic potential equalisation
- 4 tapped rods with eyebolts

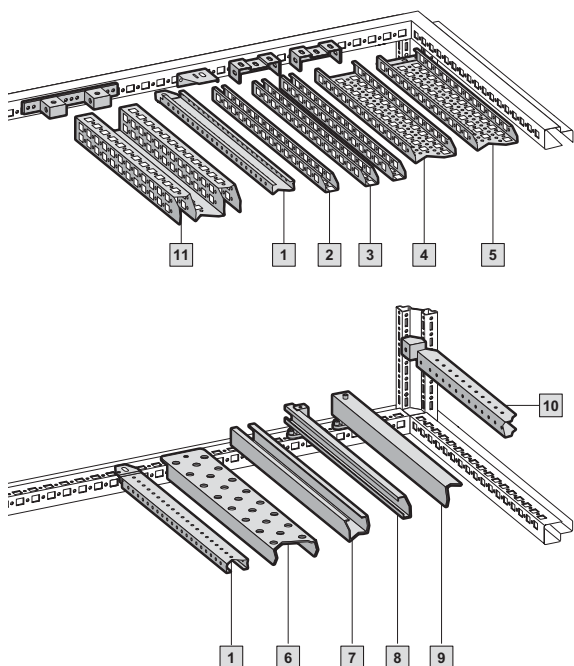
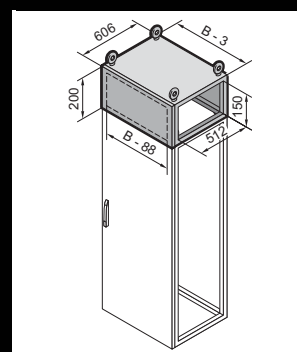

#### ! Accessories:

Designation	Page
<b>1</b> TS punched rail 18 x 38 mm	462
<b>2</b> PS punched rail 23 x 23 mm with angle bracket	463
<b>3</b> PS punched rail 23 x 23 mm with support bracket	463
<b>4</b> PS punched section without mounting flange 23 x 73 mm, with support bracket PS	464
<b>5</b> PS punched section with mounting flange 23 x 73 mm	464
<b>6</b> Support rail	466
<b>7</b> System support rails	466
<b>8</b> C rail 30/15 with support bracket or spacer	465
<b>9</b> Cable clamp rail	527
<b>10</b> TS punched rail 25 x 38 mm	461
<b>11</b> TS punched section without mounting flanges, 45 x 88 mm	461

### Side panel

#### for top mounting module

To finish off the side of a top mounting module or bayed suite.

#### Material:

Sheet steel, 1.5 mm

#### Surface finish:

Spray-finished, textured paint

#### Colour:

RAL 7035

#### Supply includes:

- 2 side panels
- 8 retainers with automatic potential equalisation

Packs of	Model No. TS
2	<b>8801.775</b>



# Roof/wall mounting

## Roof



### Roof plates

#### for SV-TS

For SV-TS 8 enclosures without roof plate and in exchange for the standard roof plate for other TS enclosures.

**Material:**  
Sheet steel, 1.5 mm

**Surface finish:**  
Textured paint

**Colour:**  
RAL 7035

**Supply includes:**  
Assembly parts.

#### IP 55, solid

For enclosures		Packs of	Model No. SV
Width mm	Depth mm		
300	600	1	9671.636
400	600	1	9671.646
600	600	1	9671.666
800	600	1	9671.686
300	800	1	9671.638
400	800	1	9671.648
600	800	1	9671.668
800	800	1	9671.688

#### IP 43 with ventilation hole Build height: 93 mm

For enclosures		Packs of	Model No. SV
Width mm	Depth mm		
300	600	1	9671.736
400	600	1	9671.746
600	600	1	9671.766
800	600	1	9671.786
300	800	1	9671.738
400	800	1	9671.748
600	800	1	9671.768
800	800	1	9671.788

Extended delivery times.

#### For cable entry glands

For enclosures		Required number of glands	Packs of	Model No. SV
Width mm	Depth mm			
600	400	2	1	9665.943
850	400	3	1	9665.953
1100	400	4	1	9665.963
300	600	2	1	9671.536
400	600	3	1	9671.546
600	600	4	1	9665.903
800	600	8	1	9671.586
850	600	6	1	9665.913
1100	600	8	1	9665.923
300	800	2	1	9671.538 <sup>1)</sup>
400	800	4	1	9671.548
600	800	8	1	9671.568 <sup>1)</sup>
800	800	8	1	9671.588 <sup>1)</sup>

<sup>1)</sup> Extended delivery times.

#### IP 2X with ventilation hole Build height: 72 mm

For enclosures		Packs of	Model No. SV
Width mm	Depth mm		
400	600	1	9671.846 <sup>1)</sup>
600	600	1	9660.235
800	600	1	9660.245
1000	600	1	9660.255
1200	600	1	9660.265
400	800	1	9671.848 <sup>1)</sup>
600	800	1	9659.525 <sup>1)</sup>
800	800	1	9659.535 <sup>1)</sup>
1000	800	1	9659.545 <sup>1)</sup>
1200	800	1	9659.555 <sup>1)</sup>

<sup>1)</sup> Extended delivery times.

#### With pressure relief valve Build height: 25 mm

For enclosures		Packs of	Model No. SV
Width mm	Depth mm		
400	600	1	9671.446
600	600	1	9660.935
800	600	1	9660.945
1000	600	1	9660.955
1200	600	1	9660.965
400	800	1	9671.448
600	800	1	9671.468
800	800	1	9671.488

Extended delivery times.



#### Also required:

Cable entry gland,  
see page 435.

### Cable entry glands

- Including seal
- External dimensions 250 x 160 mm
- Protection category IP 55

Design	Material	Colour	Packs of	Model No. SV
<b>1</b> 14 x M25/32	Insulating material	RAL 7032	1	<b>9665.750</b>
<b>2</b> 2 x M25/32/40, 1 x M32/40/50, 2 x M40/50/63	Insulating material	RAL 7032	1	<b>9665.760</b>
<b>3</b> With sealing membranes 32 x Ø 7 – 16 mm, 4 x Ø 10 – 20 mm, 3 x Ø 14 – 26 mm	Insulating material	RAL 7032	1	<b>9665.770</b>
<b>4</b> With entry glands up to 66 mm diameter	Insulating material	RAL 7032	1	<b>9665.780</b>
<b>5</b> Solid	Sheet steel, spray-finished	RAL 7035	4	<b>9665.785</b>

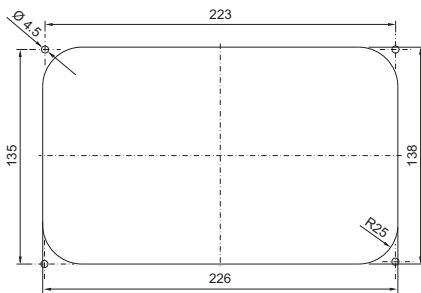

Cut-out dimensions for SV 9665.750 to SV 9665.785

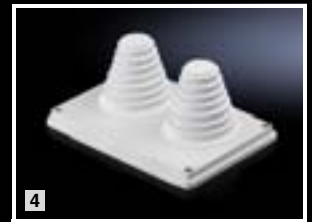

# Roof/wall mounting

## Roof



### Roof plate

#### for cable entry, two-piece for DK-TS

In exchange for the standard roof. Equipped with a sliding angular bracket in the rear section. Rubber cable clamp strip on both sides for attaching cable bundles and bunched cables. Thanks to the symmetrical design of the TS 8 frame, side cable entry can also be achieved by rotating the roof plate.

The two-piece design additionally allows easy retro-fitting, by simply removing the front part of the plate for retrospective cable entry.

For active ventilation, a fan mounting plate may be fitted in the front section of the enclosure (not in conjunction with 482.6 mm (19") mounting frames).

To this end, the roof plate must be raised by at least 20 mm using spacers.

**Material:**  
Sheet steel

**Colour:**  
RAL 7035

For enclosures		Model No. DK
Width mm	Depth mm	
600	400	<b>7826.645<sup>1)</sup></b>
600	600	<b>7826.665</b>
600	800	<b>7826.685</b>
600	1000	<b>7826.605</b>
600	1200	<b>7826.625</b>
800	400	<b>7826.845</b>
800	600	<b>7826.865</b>
800	800	<b>7826.885</b>
800	1000	<b>7826.805</b>
1200	400	<b>7826.245</b>
800	1200	<b>7826.825</b>

<sup>1)</sup> Extended delivery times.



#### Accessories:

- Fan mounting plate, see page 221.
- Spacers, see page 438.

**Detailed drawing:**  
Available on the Internet.



### Roof plate, multi-piece

#### for side cable entry in TS

The roof plate allows side cable entry on both sides across the entire enclosure depth. Sliding brackets at the sides allow variable adaptation of the entry opening. Additional rubber cable clamp strips secure the inserted cable bundles and cable sections.

The multi-piece design allows convenient retro-fitting, as the roof plate is removable even with the cables already inserted.

Passive ventilation is supported by raising the roof with spacers.

**Material:**  
Sheet steel

**Surface finish:**  
Spray-finished

**Colour:**  
RAL 7035

**Supply includes:**  
Assembly parts.

For enclosures		Model No. DK
Width mm	Depth mm	
800	1000	<b>7526.807</b>
800	1200	<b>7526.827<sup>1)</sup></b>

<sup>1)</sup> Extended delivery times.



#### Accessories:

Spacers, see page 438.

# Roof/wall mounting

## Roof

### Roof plate

#### for cable entry on all sides for DK-TS

The roof plate has sliding plates for cable entry on all four sides, and therefore allows individual selection of cable routing tailored to the specific requirements. After cable entry, the sliding plate is closed again as far as possible, and the rubber cable clamp strips supplied loose then seal the cable entry area.

**Material:**  
Sheet steel

**Colour:**  
RAL 7035

**Supply includes:**  
Assembly parts.

For enclosures		Model No. DK
Width mm	Depth mm	
800	800	<b>7826.588</b>

**Detailed drawing:**  
Available on the Internet.



### Roof plate, vented

#### for DK-TS

In exchange for the standard roof.

#### Variant 1:

72 mm high roof plate, all-round vent slots, optionally with clamp strip for cable entry. The two-piece design with cable entry allows easy retro-fitting, by simply removing the front part of the plate. The cables are held in position via a guide at the side.

**Material:**  
Sheet steel

**Colour:**  
RAL 7035

#### One-piece without cable entry

For enclosures		Model No. DK
Width mm	Depth mm	
600	600	<b>7826.766</b>
600	800	<b>7826.768</b>
600	1000	<b>7826.760<sup>1)</sup></b>
800	600	<b>7826.786</b>
800	800	<b>7826.788</b>
800	1000	<b>7826.780</b>

<sup>1)</sup> Extended delivery times.

#### Two-piece with cable entry

For enclosures		Model No. DK
Width mm	Depth mm	
600	600	<b>7826.669</b>
600	800	<b>7826.689</b>
800	600	<b>7826.869</b>
800	800	<b>7826.889</b>
800	1000	<b>7826.809</b>

#### Variant 2:

Ventilation holes (Ø 5 mm) are incorporated all-round into the 97 mm high roof plate. In conjunction with the vented glazed and sheet steel door, the roof plate matches the door design to perfection.

**Material:**  
Sheet steel

**Colour:**  
RAL 7035

For enclosures		Model No. DK
Width mm	Depth mm	
800	600	<b>7826.866</b>
800	800	<b>7826.886</b>
800	1000	<b>7826.806<sup>1)</sup></b>

<sup>1)</sup> Extended delivery times.



#### Accessories:

Fan mounting plate,  
see page 221.

**Detailed drawing:**  
Available on the Internet.



# Roof/wall mounting

## Roof



### Roof mounting screw

For screw-fastening the roof plate instead of eyebolts. With the TS 8, the contact washers for potential equalisation may be taken from the eyebolts included with the supply of the enclosures.

**Material:**

Steel

**Surface finish:**

Zinc-plated

Packs of	Model No. PS
20	<b>4198.000</b>



### Spacers

**for roof plate TS**

To raise the TS 8 roof for ventilation purposes, in three different heights.  
Not suitable for crane transportation!

**Material:**

Hexagonal sectional steel

**Surface finish:**

Zinc-plated

**Supply includes:**

Assembly parts.

Height mm	Packs of	Model No. SZ/DK
10	4	<b>2422.000</b>
20	4	<b>2423.000</b>
50	4	<b>7967.000</b>



### Eyebolts

**for TS, ES**

For crane transportation of enclosures, where not already included in the supply.  
Thread: M12

Packs of	Model No. PS
4	<b>4568.000</b>



### Eyebolts

**for CM**

For crane transportation of enclosures, with reinforcement plate to be inserted underneath. Mounting via the two holes in the top of the CM.  
Thread: M12

**Supply includes:**

- Eyebolts
- Reinforcement plates

Packs of	Model No. CM
2	<b>2509.500</b>



### Eyebolts

**for AE**

For crane transportation of enclosures, with reinforcement plate to be inserted underneath.  
Thread: M12

**Supply includes:**

- Eyebolts
- Reinforcement plates

Packs of	Model No. SZ
4	<b>2509.000</b>

# Roof/wall mounting

## Wall mounting

### Wall mounting bracket

For the attachment of KL, EB, BG and EL enclosures as well as DK wall-mounted distributors.

**Supply includes:**

Assembly parts for mounting on the enclosure.

**Note:**

For hygiene reasons, and in view of the protection category, the stainless steel enclosures do not have any drilled holes for the wall mounting brackets.

Material	Wall distance mm	Packs of	Model No. SZ
Brass, nickel-plated	8	4	1580.000
Sheet steel zinc-plated, passivated	8	4	1590.000
Stainless steel 1.4301 (AISI 304)	8	4	1594.000

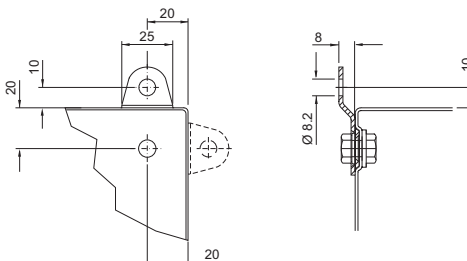

### Wall mounting bracket

**for AE**

For attaching to the enclosure from the outside. Simply insert the expandable dowel into the enclosure hole from the outside, and screw-fasten the wall bracket from the outside.

**Material:**

Sheet steel

**Surface finish:**

Zinc-plated

**Supply includes:**

Wall bracket pre-fitted with seal and expandable dowel.

Wall distance mm	Packs of	Model No. SZ
15	4	2508.100

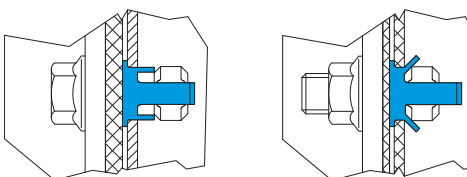

### Wall mounting bracket

For the attachment of KL, EB, BG, AE, CM and EL enclosures, TP consoles as well as DK wall-mounted distributors and small fibre-optic distributors.

**Supply includes:**

Assembly parts for mounting on the enclosure.

**Possible alternative:**

Wall spacer bracket Hygienic Design, see page 156.

Material	Wall distance (A) mm	Packs of	Model No. SZ
Sheet steel zinc-plated, passivated	40	4	2503.010
	10	4	2508.010
Stainless steel 1.4301 (AISI 304)	10	4	2433.000
Stainless steel 1.4404 (AISI 316L)	10	4	2433.500

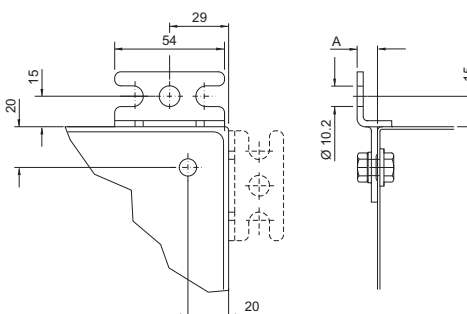

# Roof/wall mounting

## Wall mounting



### Wall mounting bracket

#### for KS

For attachment to the wall, only possible from the outside of the enclosure.

#### Material:

Fibreglass-reinforced polyamide<sup>1)</sup>

#### Supply includes:

Assembly parts for mounting on the enclosure.

Colour	Packs of	Model No. KS/KE
Similar to RAL 7035	4	<b>1483.010</b>
Similar to RAL 9011	4	<b>9266.000<sup>1)</sup></b>

<sup>1)</sup> With graphite additive for Ex applications.

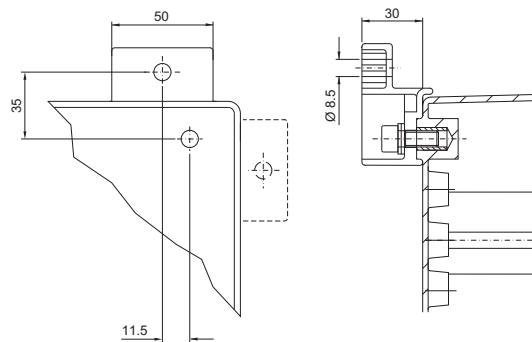

### Wall angle

For compact enclosures (additional holes required in the enclosure).

#### Supply includes:

Assembly parts for mounting on the enclosure.

Material	Colour	Packs of	Model No. SZ
Sheet steel	RAL 7035	4	<b>2505.510</b>
Stainless steel 1.4301 (AISI 304)	—	4	<b>2583.010</b>

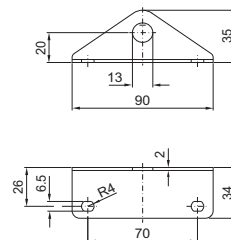

### Wall bracket

For wall mounting of TS and ES enclosures at the roof, e.g. with heavy components on the door or built-in swing frame.

#### Material:

Sheet steel

#### Surface finish:

Zinc-plated

Packs of	Model No. PS
4	<b>4595.000</b>

#### Possible alternative:

With TS 8 inside the enclosure (without mounting plate), baying bracket TS 8800.470, see page 398.



# Roof/wall mounting

## Wall mounting

### Wall mounting bracket

#### for CS wall-mounted enclosures

For mounting on a wall or panel.

#### Material:

Stainless steel 1.4301 (AISI 304)

Packs of	Model No. CS
4	9765.120



### Pole clamp

#### for KL, EB, BG, AE, KS and CS wall-mounted enclosures

For reliable, convenient fastening to round or square poles.

For pole diameter/size:

- Ø from 40 to 190 mm
- □ from 50 to 150 mm

#### Material:

- Mounting angles, clamping section: Sheet steel
- Clamping strap: Stainless steel 1.4301 (AISI 304)

#### Surface finish:

Mounting angles, clamping section: Zinc-plated

#### Supply includes:

- 2 mounting angles, 600 mm long
- 4 clamping sections
- 2 clamping straps
- 4 clamping brackets
- 4 screws and captive nuts M8 for mounting on the enclosure.

Packs of	Model No. SZ
1 set	2584.000



### Enclosure connectors

#### Adjustable

Between Command Panels, terminal boxes, compact enclosures and horizontal or vertical surfaces.

Pre-mount the connector halves on both sides, screw together and secure with a locking screw, and/or adjust the angle of rotation.

#### Rotation range:

±105° adjustable in 7.5° stepped increments.

#### Material:

Die-cast zinc

#### Surface finish:

Powder-coated

#### Colour:

RAL 7035

#### Supply includes:

Assembly parts for both sides.

Packs of	Model No. CP
1 set	6016.200

#### Note:

The locking screws may be exchanged for standard, commercially available clamping levers (M10 x 50 mm).

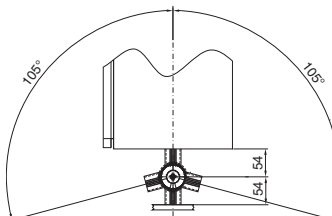

# Roof/wall mounting

## Wall mounting



### Frame connector, adjustable for Comfort Panel

Between the command panel and keyboard housing and horizontal or vertical surfaces.

**Rotation range:**

Adjustable in 8° stepped increments, see drawing.

**Material:**

Die-cast zinc

**Surface finish:**

Powder-coated

**Colour:**

RAL 7024

**Supply includes:**

Assembly parts and clamping levers for both sides.

Packs of	Model No. CP
1 set	6005.500

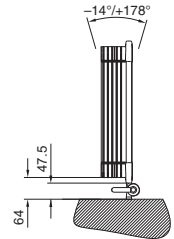
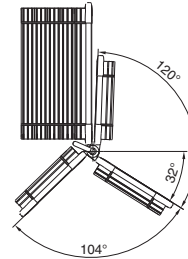

### Wall mounting bracket

**Vertically hinged**

Between the Compact Panel and horizontal or vertical surfaces.

**Rotation range:**

180° adjustable on a 7.2° pitch pattern.

**Material:**

- Wall mounting bracket: Sheet steel
- Knurled screw: Steel with plastic knurled handle

**Supply includes:**

Locking screw and assembly parts for mounting on the Compact Panel.

Packs of	Model No. CP
1 set	6341.000

# Interior installation

## Mounting plates

### Mounting plates

#### for KL and KL-HD

For component installation outside of the enclosure. Assembly screws included as accessories with the enclosure.

#### Material:

Sheet steel, 2 mm

#### Surface finish:

Zinc-plated



#### Accessories:

Self-tapping screws SZ 2487.000, see page 478.



#### Possible alternative:

Support rails, see page 467.

#### Detailed drawings:

Available on the Internet.



For size mm	For Model No. KL and KL-HD	Model No. KL
150 x 150	1500.510, 1514.510, 1521.010, 1527.010, 1670.600, 1671.600	<b>1560.700</b>
200 x 150	1528.510, 1529.510	<b>1575.700</b>
300 x 150	1501.510, 1515.510, 1522.010, 1530.510	<b>1561.700</b>
400 x 150	1589.510	<b>1576.700</b>
200 x 200	1502.510, 1516.510, 1523.010, 1528.010, 1672.600	<b>1562.700</b>
300 x 200	1503.510, 1517.510, 1524.010, 1529.010, 1531.510, 1674.600	<b>1563.700</b>
400 x 200	1504.510, 1518.510, 1525.010, 1532.510, 1675.600	<b>1564.700</b>
500 x 200	1505.510, 1533.510	<b>1565.700</b>
300 x 300	1507.510, 1526.010, 1535.510	<b>1567.700</b>
400 x 300	1508.510, 1530.010, 1536.510, 1676.600	<b>1568.700</b>
500 x 300	1509.510, 1537.510	<b>1569.700</b>
400 x 400	1511.510, 1539.510	<b>1571.700</b>

### Mounting plate infill

#### for TS

For a continuous mounting surface in bayed suites where the mounting plate is set forward.

#### Material:

Sheet steel, 2 mm

#### Surface finish:

Zinc-plated

#### Supply includes:

Assembly parts.

For enclosure height mm	Model No. TS
1800	<b>4590.700</b>
2000	<b>4591.700</b>
2200	<b>4592.700</b>



# Interior installation

## Mounting plates

### Mounting plate attachment

For additional clamping and to reduce potential vibration of the mounting plate. Select according to mounting position, installation type and enclosure.

**Material:**

Sheet steel

**Surface finish:**

Zinc-plated

**Supply includes:**

Assembly parts.



**For TS**

Installation options:

- Side, at half height in conjunction with mounting plate infill
- In the penultimate position
- Set forward (supplied state)

Benefit:

No impairment to the mounting surface, but mounting is only possible from the enclosure rear.

Packs of	Model No. TS
10	<b>8800.630</b>



**Accessories:**

Mounting plate infill, see page 443.



**For TS**

Installation options:

- Side
- Rear, flush with enclosure frame

Benefit:

No impairment to the mounting surface, but mounting is only possible from the enclosure rear.

Packs of	Model No. TS
10	<b>8800.610</b>



**For TS**

Installation options:

- Side
- Rear, flush with enclosure frame
- Set forward on a 25 mm pitch pattern

Benefit:

No impairment to the mounting surface. May optionally be used for attachment or screw fastening.

Packs of	Model No. TS
10	<b>8800.090</b>



**Also required:**

Punched section with mounting flange 17 x 73 mm for the inner mounting level, see page 459 (with Fig. 3).

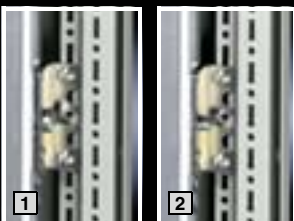

**1** Mounting plate screw-fastened in the rear-most installation position.

**2** Mounting plate screw-fastened from the rear in the rearmost installation position.

**3** Mounting plate in a set forward position, either attached or screw-fastened (not shown).



**For TS**

Installation options:

- Side
- Rear, flush with enclosure frame

Slide over the plate at the side and secure with screws. Additionally, the mounting plate may be drilled and screw-fastened at the rear C-edge.

Packs of	Model No. TS
10	<b>8800.050</b>

# Interior installation

## Mounting plates

### Mounting plate attachment

For additional clamping and to reduce potential vibration of the mounting plate. Select according to mounting position, installation type and enclosure.

**Material:**  
Sheet steel

**Surface finish:**  
Zinc-plated

**Supply includes:**  
Assembly parts.

#### For TS, ES

Installation options:

- All-round
- Set forward on a 25 mm pitch pattern

Slide in between the bar and plate from below or above or from the side, and secure with screws.

Packs of	Model No. TS
10	4593.000



#### Also required:

- Support strip (with TS for inner level), see page 462 or
- Punched section with mounting flange (with TS for inner level), see page 459 or
- Punched rails and punched sections without mounting flange, see page 463/464.

#### For TS, ES

Installation options:

- On the top and bottom of the mounting plate (with ES all-round)
- Rear, flush with enclosure frame

Screw in the clip behind the plate and secure with screws.

Packs of	Model No. TS
10	4576.000

### Installation kit

#### for mounting plates TS, back-to-back

The minimal distance between the two mounting plates ensures a maximum installation depth for installed equipment on both sides.

**Material:**  
Sheet steel

**Surface finish:**  
Zinc-plated

#### Note:

Build height front and rear  
with central installation =  
(enclosure depth – 48 mm) : 2  
For example:  
TS 8806.521 = Depth 600 mm  
Build depth = 2 x 276 mm

Packs of	Model No. TS
1 set	8800.280



# Interior installation

## Mounting plates



### Mounting plate slide block

#### for CM

In this way, populated mounting plates slide easily into the mounting position for installation and/or clip-fastening.

#### Benefits:

- Installation without drilling
- Simply screw-fasten to the existing holes in the mounting plate
- May be reused, unscrew to detach

#### Material:

Polyamide

#### Colour:

Similar to RAL 9011

#### Supply includes:

Assembly parts.

Packs of	Model No. CM
2	5001.070



### Slide rails

#### for mounting plate TS

Slides in from the side.

- Attachment of the mounting plate to the slide rails via captive nuts and screws.
- Mounting of the slide rails directly on the enclosure frame, depth-adjustable on a 25 mm pitch pattern.

#### Technical specifications:

Possible mounting depth T6 – 25 mm, refer to the Internet.

#### Material:

Sheet steel

#### Surface finish:

Zinc-plated

#### Supply includes:

Assembly parts.

For enclosure width mm	Packs of	Model No. TS
600	2	8802.260
800	2	8802.280
1200	2	8802.220



### Mounting plate adjustment bracket

#### for KS

Infinitely adjustable.

Other equipment can also be installed in this way, instead of the mounting plate.

#### Material:

Sheet steel

#### Surface finish:

Zinc-plated

#### Supply includes:

Assembly parts.

- [B]** Enclosure width:  
 – 76 mm (KS 1481.000)  
 – 104 mm (KS 1491.000)

- [H]** Enclosure height:  
 – 150 mm

For enclosures KS	Packs of	Model No. KS
1423.500, 1432.500, 1434.500, 1444.500, 1446.500, 1448.500, 1449.500, 1466.500, 1467.500	4	1481.000
1400.500, 1453.500, 1454.500, 1468.500, 1469.500, 1479.500, 1480.500	4	1491.000

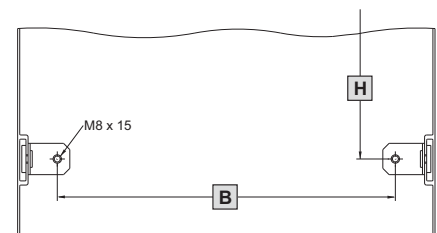

# Interior installation

## Mounting plates

### Mounting plate attachment

#### for CM, TP one-piece console, TP pedestal for high dynamic loads

For example, if a direct connection between the mounting plate and the enclosure is required (cranes etc.).

Tested as per DIN EN 60 721 severity 4M4, with a weight of 150 kg evenly distributed over the mounting plate.

Simply screw-fasten to the existing holes in the mounting plate to pre-assemble for:

#### Wall mounting from the inside

Direct using a bracket and wall/support mounted enclosure.

#### Wall mounting from the outside

Screws for wall mounting brackets (see page 439) can easily be screwed into the plate nuts from the outside.

#### Material:

Sheet steel

#### Surface finish:

Zinc-plated

#### Supply includes:

Assembly parts.

Packs of	Model No. CM
1 set	5001.075



### Cross-brace for mounting plates

#### for TS, ES

Additional horizontal rigidity for vibration resistance and/or stabilisation of wide mounting plates. This brace may also be used as an attachment aid for heavy components.

#### Material:

Sheet steel

#### Surface finish:

Zinc-plated

#### Supply includes:

- 2 sections
- 4 clamping sections
- 4 grub screws M10 x 16 mm

For enclosure width mm	Model No. TS
1200	4333.120
1600	4333.160
1800	4333.180

Other widths available on request.



### Transport handles for mounting plates

#### for TS, ES

May be used at any given position in the side C-fold

Benefits include:

- Can be used for people of different heights
- Optimised force transmission
- Easy handling

Packs of	Model No. SZ
2	2415.500



# Interior installation

## Mounting plates



### Partial mounting plates

for TS, CS Toptec

For

- Universal interior installation, also in conjunction with punched sections with mounting flanges and support strips. Defective assemblies are quickly and easily replaced
- Additional mounting levels.

Partial mounting plates are fastened directly onto the vertical enclosure sections via the inner mounting level using the assembly parts supplied loose. In this mounting position (in both the width and the depth) they form one level with TS punched sections with mounting flanges 17 x 73 mm and TS support strips for the inner mounting level.

#### Material:

Sheet steel, 2.5 mm

#### Surface finish:

Zinc-plated

#### Supply includes:

Assembly parts.



#### Accessories:

- TS punched section with mounting flange 17 x 73 mm for the outer mounting level, see page 459.
- TS support strip, see page 462.
- Hinge attachment, see page 449.
- Self-tapping screws, SZ 2487.000, see page 478.

For installation in										Size mm	Packs of	Model No. TS
Enclosure width mm					Enclosure depth (side) mm							
400	600	800	1000	1200	400	500	600	800				
■	■				■		■			500 x 300	1	8614.640
	■					■	■			500 x 400	1	8614.650
	■						■			500 x 500	1	8614.660
	■	■					■	■		500 x 700	1	8614.680
	■						■			500 x 775	1	8614.675 <sup>1)</sup>
■		■			■			■		700 x 300	1	8614.840
		■				■		■		700 x 400	1	8614.850
		■						■		700 x 700	1	8614.880
■			■		■					900 x 300	1	8614.040
			■			■				900 x 400	1	8614.050
	■		■					■		900 x 500	1	8614.060
■				■	■					1100 x 300	1	8614.240
				■		■				1100 x 400	1	8614.250
	■			■				■		1100 x 500	1	8614.260

<sup>1)</sup> Also suitable for installing in  
 - PC enclosures based on TS behind the lower front door  
 - IW enclosures, height 900 and 1000 mm

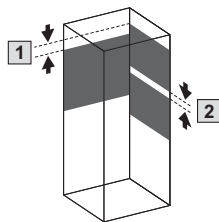

When **installing around corners** due to collision between the assembly components

- 1** At least 75 mm (adjustable on a 25 mm pitch pattern).

Maximum space utilisation

- 2** 1 mm (adjustable on a 25 mm pitch pattern).

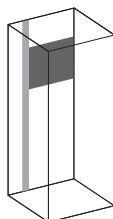

#### Partial installation

Partial utilisation of the enclosure depth or width is also possible. In this example, using a PS punched section without mounting flange 23 x 73 mm, see page 464.



#### Set forward installation position

Quickly and easily achieved with four TS punched sections with mounting flanges 17 x 73 mm for the outer mounting level, see page 459.

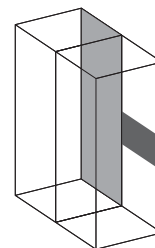

#### Continuously flush

In bayed enclosures, the partial mounting plate is in the rearmost position flush with the standard mounting plate. This facilitates continuous component mounting.



# Interior installation

## Mounting plates

### Hinge attachment for partial mounting plate TS

**Material:**  
Steel

**Surface finish:**  
Zinc-plated

**Supply includes:**  
Assembly parts.

Packs of	<b>Model No. TS</b>
1 set	<b>8614.100</b>

#### ! Also required:

Depending on the installation position  
**1** Installation kit for swing frame, small,  
 for enclosure width  
 600 mm, Model No. SR 2377.860,  
 800 mm, Model No. SR 2377.880,  
 see page 543.

**2** PS punched section without mounting flange  
 23 x 73 mm according to the enclosure depth,  
 see page 464.  
 Support brackets TS 8800.330,  
 see page 473.

Side installation:  
 In conjunction with hinge, for side panel,  
 see page 387, for an enclosure depth of 600 or  
 800 mm, side installation is identical to installation  
 parallel to the front.



### Examples

#### In the highest or lowest position

At the front

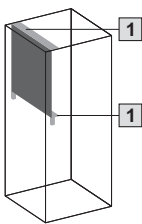

Set back

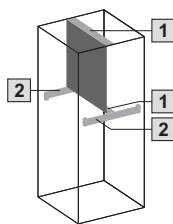

#### In a central position

At the front

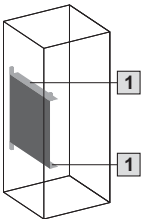

Set back

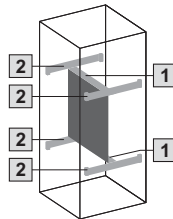

#### Side installation

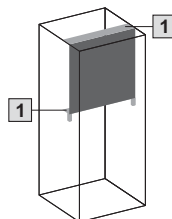

### Partial mounting plates for ES, CS Basic and modular enclosures

For additional mounting levels.

**Material:**  
Sheet steel, 2.5 mm

**Surface finish:**  
Zinc-plated

**Supply includes:**  
Assembly parts.

For enclosure width mm	Width x height mm	Packs of	<b>Model No. PS</b>
600	492 x 373	2	<b>4131.700</b>
600	492 x 573	2	<b>4132.700</b>
800	692 x 573	2	<b>4137.700</b>

#### + Accessories:

- PS punched section without mounting flange, 23 x 73 mm, see page 464.
- Self-tapping screws, SZ 2487.000, see page 478.



# Interior installation

## Mounting plates



### Partial mounting plates, locatable into rails

#### for TP

For installation in:

- Console and desk unit on the interior installation system rails
- Punched sections with mounting flanges or support strips fitted to the side of the pedestal in the depth
- Other enclosures mounted on rails with 25 mm pitch pattern punchings

For easy mounting on pre-fitted assembly screws. Bayable by screw-fastening at the sides.

#### Material:

Sheet steel

#### Surface finish:

Zinc-plated

#### Supply includes:

Assembly parts.

Width mm	Height mm	Packs of	Model No. TP
200	437	1	<b>6730.310</b>
500	437	1	<b>6730.330</b>
700	437	1	<b>6730.340</b>

For console/desk unit Width mm	Max. partial mounting plate installation
600	1 x TP 6730.330
800	1 x TP 6730.340
1200	2 x TP 6730.310 1 x TP 6730.340
1600	3 x TP 6730.330

1 From width 500 mm

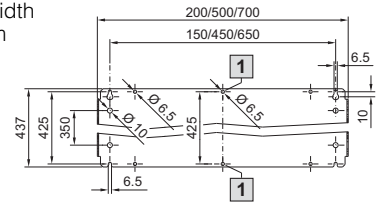

### Support rail, locatable

#### for TS, CM, PC, TP

To fit:

- Internal mounting behind the mounting compartment, small, of the PC enclosure,
- Mounting on the vertical TS enclosure section,
- Mounting in CM and TP on the interior installation rail.

Integral 25 mm pitch pattern of holes to accommodate:

- Mounting plate, small
  - PS punched section without mounting flange via support brackets PS as a second mounting level, if due to an installed:
  - Mounting plate infill
  - Cable duct, vertical
- no punched sections or other assemblies can be mounted in the depth.

Static load: max. 15 kg.

#### Material:

Sheet steel, 2.0 mm

#### Surface finish:

Zinc-plated

#### Supply includes:

Assembly parts.

Packs of	Model No. TS
1 set	<b>8612.200</b>

#### Accessories:

PS punched section without mounting flange, see page 464.

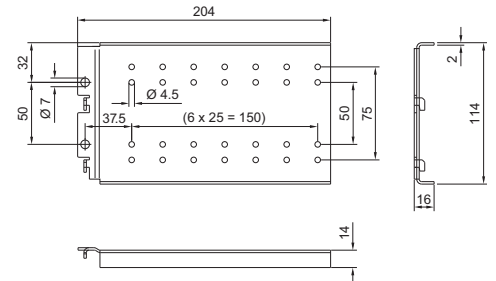

### Mounting plate, small

For external mounting on:

- Support rail TS, locatable, depth-adjustable on a 25 mm pitch pattern,
- Punched sections with mounting flanges, attached to the outer mounting level.

#### Material:

Sheet steel, 1.5 mm

#### Surface finish:

Zinc-plated

#### Supply includes:

Assembly parts.

Enclosure width mm	Packs of	Model No. TS
600	1	<b>8612.600</b>

#### Accessories:

- TS punched section with mounting flange, see page 459.
- Self-tapping screws, SZ 2487.000, see page 478.

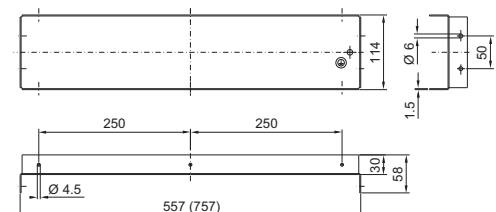

# Interior installation

## Mounting plates

### Mounting plate

#### for TS, 400 mm wide

Depth-adjustable on a 25 mm pitch pattern.

#### Material:

Sheet steel, 3 mm

#### Surface finish:

Zinc-plated

#### Supply includes:

Assembly parts.



#### Accessories:

- TS 18 x 38 mm punched rail, used as mounting plate slide rail, see page 462.
- TS width divider, for installation in wider enclosures, see page 376.

For enclosure height mm	Model No. TS
1800	<b>8614.180</b>
2000	<b>8614.200</b>

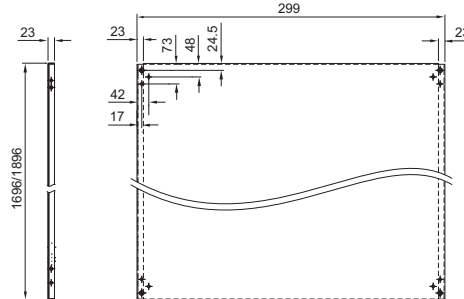

### Mounting plates

#### for CS Toptec, Basic and modular enclosures

For the configuration of mounting levels.

The mounting plates are depth-adjustable on a 25 mm pitch pattern.

#### Material:

Aluminium, 3 mm

#### Supply includes:

Assembly parts.

#### Note:

For an enclosure width of 1200 mm, partial installation with one or two 600 mm wide mounting plates is possible.

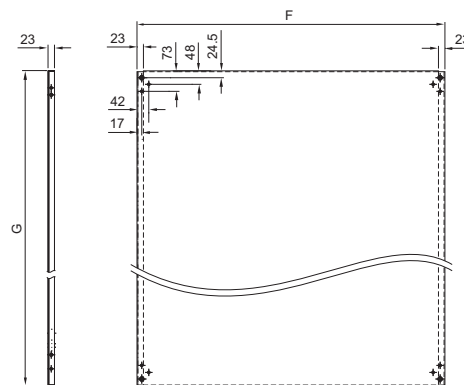

For enclosure		F	G	Model No. CS
Width mm	Height mm			
600	800	499	696	<b>9765.090</b>
600	1200	499	1096	<b>9765.092</b>
800	800	699	696	<b>9765.097</b>
800	1200	699	1096	<b>9765.095</b>
800	1600	699	1496	<b>9765.096</b>
1200	1200	1099	1096	<b>9765.191</b>

# Interior installation

## Rail systems

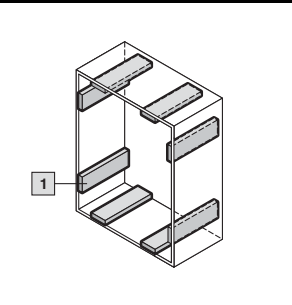

### AE installation examples with TS system rails

1 Rails for interior installation AE (preparing for installation)							
For enclosure depth mm	Packs of	210	250	300	350	Page	
<b>Model No. SZ</b>	4	2373.210	2373.250	2373.300	2373.350	459	

  

Interior installation in the width and height								
2 TS punched section with mounting flange, 17 x 73 mm	AE from enclosure width/height mm	A <sup>1)</sup> mm	Packs of	Model No. TS				459
	380	225	4	8612.130	8612.130	8612.130	8612.130	
500	325	4	8612.140	8612.140	8612.140	8612.140		
	375	4	8612.040	8612.040	8612.040	8612.040		
600	425	4	8612.150	8612.150	8612.150	8612.150		
	475	4	8612.050	8612.050	8612.050	8612.050		
760	525	4	8612.160	8612.160	8612.160	8612.160		
	575	4	8612.060	8612.060	8612.060	8612.060		
1000	725	4	8612.180	8612.180	8612.180	–		
	775	4	8612.080	8612.080	8612.080	–		
	875	4	8612.090	8612.090	8612.090	–		
1200	925	4	–	–	8612.100	–		
	975	4	–	–	8612.000	–		
1400	1125	4	–	–	8612.120	–		
	1175	4	–	–	8612.020	–		

3 TS support strips	400	325	20	4694.000	4694.000	4694.000	4694.000	462
	500	425	20	4695.000	4695.000	4695.000	4695.000	
	600	525	20	4696.000	4696.000	4696.000	4696.000	
	800	725	20	4697.000	4697.000	4697.000	4697.000	

<sup>1)</sup> A = Rail mounting distance

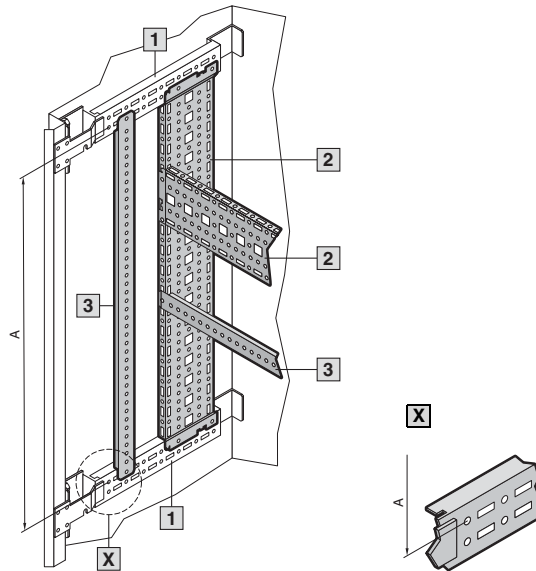

### CM installation examples with TS system rails

#### 1 Rails for interior installation (preparing for installation)

For enclosure width/height mm	Packs of	600	800	1000	1200	1400	Page
<b>Model No. CM</b>	4	5001.050	5001.051	5001.052	5001.053	5001.054	459

#### 2 Base configuration rail (preparing for installation)

For enclosure depth	Packs of	300	400	-	-	-	
<b>Model No. CM</b>	2	5001.371	5001.370	-	-	-	461

#### Installation in the width

	Packs of	Model No. TS					
For enclosure width mm		600	800	1000	1200	1400	
A <sup>1)</sup> mm		575	775	975	1175	-	
<b>3</b> TS punched section with mounting flange, 17 x 73 mm	4	8612.060	8612.080	8612.000	8612.020	-	459
<b>4</b> TS support strips	20	8800.130	4579.000	-	-	-	462
<b>5</b> Support rail	slotted	4	4396.000	4398.000	-	-	466
	unslotted	4	4396.500	4398.500	-	-	466
<b>6</b> System support rails	2	4361.000	4362.000	4347.000	4363.000	-	466
<b>7</b> C rails 30/15	6	4944.000	4945.000	4946.000	4947.000	-	465
<b>8</b> Cable clamp rail	2	4191.000	4192.000	4336.000	4196.000	-	527

#### Installation in the height (individual installation e.g. with)

TS punched section with mounting flange, 17 x 73 mm	see page 459
TS support strips	see page 462

#### Installation in the depth

	For enclosure depth mm	A <sup>1)</sup> mm	Packs of	Model No. TS/PS					
<b>9</b> TS punched section with mounting flange, 17 x 73 mm	300	225	4	8612.130	8612.130	8612.130	8612.130	8612.130	459
	400	325	4	8612.140	8612.140	8612.140	8612.140	8612.140	
<b>10</b> TS support strips	400	325	20	4694.000	4694.000	4694.000	4694.000	4694.000	462
<b>11</b> TS punched rail 18 x 38 mm	400	325	4	8612.240	8612.240	8612.240	8612.240	8612.240	462
<b>12</b> PS punched rail, 23 x 23 mm	400	275	12	4169.000	4169.000	4169.000	4169.000	4169.000	463
				With mounting bracket TS (2 per rail)	24	8800.370	8800.370	8800.370	

<sup>1)</sup> A = Rail mounting distance

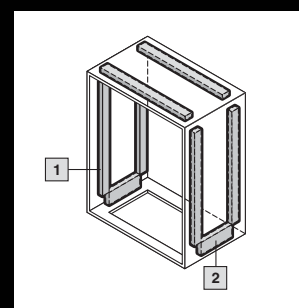
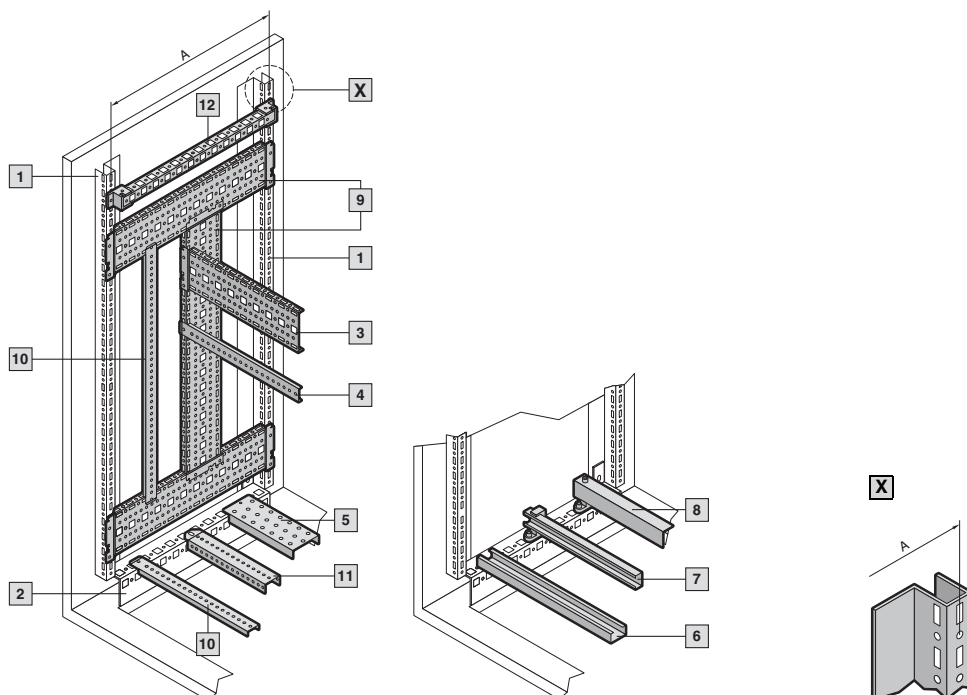

# Interior installation

## Rail systems

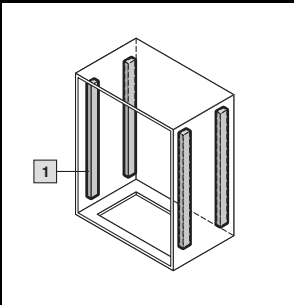

### TP pedestal Installation examples with TS system rails

1 Rails for interior installation (preparing for installation)						
For enclosure width mm	Packs of	600	800	1200	1600	Page
For enclosure height mm		675	675	675	675	
<b>Model No. CM</b>	4	5001.050	5001.050	5001.050	5001.050	459

Installation in the width						
	Packs of	<b>Model No. TS</b>				
For enclosure width mm		600	800	1200	1600	
A <sup>1)</sup> mm		575	775	1175	1575	
2 TS punched section with mounting flange, 17 x 73 mm	4	8612.060	8612.080	8612.020	-	459
3 TS support strips	20	8800.130	4579.000	-	-	462

Installation in the height (individual installation e.g. with)	
TS support strips	see page 462
TS punched rail 18 x 38 mm	see page 462

Installation in the depth								
	For enclosure depth mm	A <sup>1)</sup> mm	Packs of	<b>Model No. TS</b>				
4 TS punched section with mounting flange, 17 x 73 mm	400	325	4	8612.140	8612.140	8612.140	8612.140	459
	500	425	4	8612.150	8612.150	8612.150	8612.150	
5 TS support strips	400	325	20	4694.000	4694.000	4694.000	4694.000	462
	500	425	20	4695.000	4695.000	4695.000	4695.000	
6 TS punched rail 18 x 38 mm	400	325	4	8612.240	8612.240	8612.240	8612.240	462
	500	425	4	8612.250	8612.250	8612.250	8612.250	
7 PS punched rail 23 x 23 mm	400	325	12	4169.000	4169.000	4169.000	4169.000	463
	500	425	12	4170.000	4170.000	4170.000	4170.000	
With mounting bracket TS (2 per rail)			24	8800.370	8800.370	8800.370	8800.370	472

<sup>1)</sup> A = Rail mounting distance

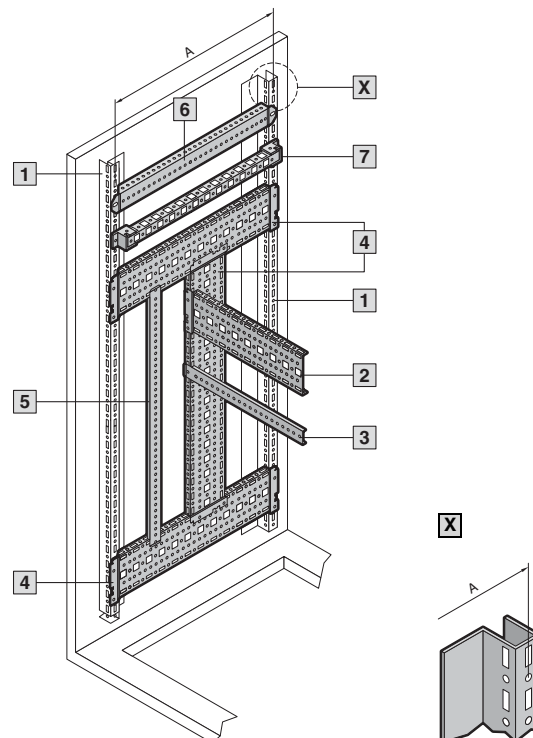

### TP pedestal Installation examples with TS system rails

1 Rails for interior installation (preparing for installation)							
For enclosure width mm		Packs of	600	800	1200	1600	Page
<b>Model No. CM</b>		4	5001.050	5001.051	5001.053	-	459
Installation in the height							
	A <sup>1)</sup> mm	Packs of	<b>Model No. TS</b>				
For enclosure width mm			600	800	1200	1600	
2 TS punched section with mounting flange, 17 x 73 mm							
For cover	375	4	8612.040	8612.040	8612.040	8612.040	459
For enclosure	425	4	8612.150	8612.150	8612.150	8612.150	459
3 TS support strips							
For cover	375	4	4309.000	4309.000	4309.000	4309.000	462
For enclosure	425	4	4695.000	4695.000	4695.000	4695.000	462
4 TS punched rail 18 x 38 mm							
For enclosure	425	4	8612.250	8612.250	8612.250	8612.250	462

<sup>1)</sup> A = Rail mounting distance

#### Console

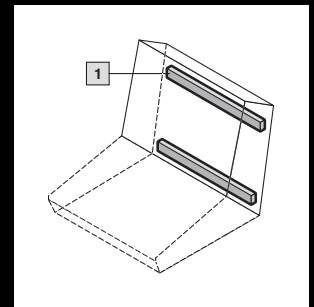
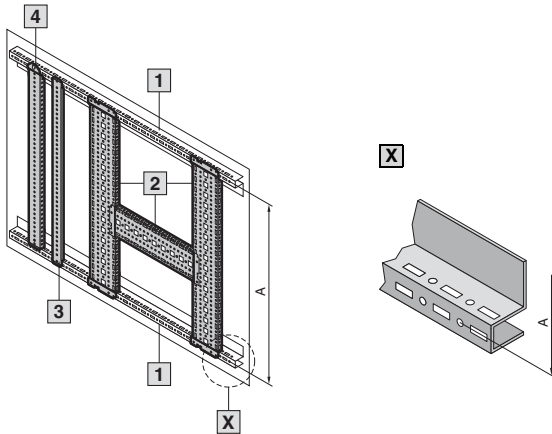

# Interior installation

## Rail systems

### TS installation examples with TS system rails

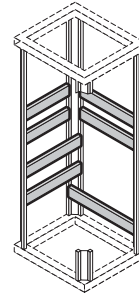
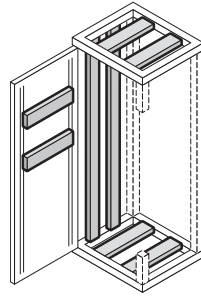
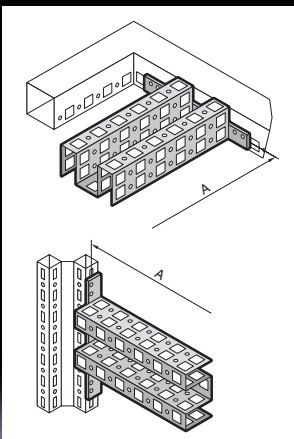
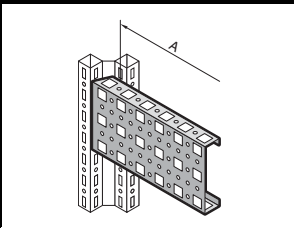
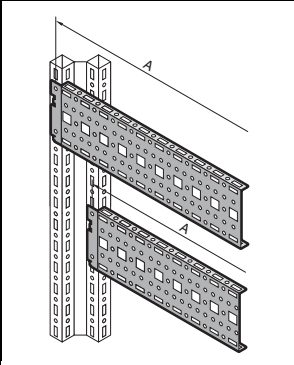

	Installation in the roof and base frame in the width/depth	Installation between vertical sections in the width/depth	
		Internal level	External level

#### TS punched section with mounting flange, 17 x 73 mm

For enclosure width/depth mm	Packs of	A <sup>1)</sup> mm	Model No. TS	A <sup>1)</sup> mm	Model No. TS	A <sup>1)</sup> mm	Model No. TS	Page
300	4	–	–	275	8612.030	225	8612.130	459
400	4	–	–	375	8612.040	325	8612.140	
500	4	–	–	475	8612.050	425	8612.150	
600	4	–	–	575	8612.060	525	8612.160	
800	4	–	–	775	8612.080	725	8612.180	
1000	4	–	–	975	8612.000	925	8612.100	
1200	4	–	–	1175	8612.020	1125	8612.120	

<sup>1)</sup> A = Rail mounting distance

#### TS punched section with mounting flange, 23 x 73 mm

For enclosure width/depth mm	Packs of	A <sup>1)</sup> mm	Model No. TS	A <sup>1)</sup> mm	Model No. TS	A <sup>1)</sup> mm	Model No. TS	Page
500	4	–	–	425	8612.550	–	–	460
600	4	–	–	525	8612.560	–	–	
800	4	–	–	725	8612.580	–	–	
1000	4	–	–	925	8612.500	–	–	
1200	4	–	–	1125	8612.520	–	–	

<sup>1)</sup> A = Rail mounting distance

#### TS punched section without mounting flanges, 45 x 88 mm

For enclosure width/depth mm	Packs of	A <sup>1)</sup> mm	Model No. TS	A <sup>1)</sup> mm	Model No. TS	A <sup>1)</sup> mm	Model No. TS	Page
500	2	375	8612.650	–	–	375	8612.650	461
600	2	475	8612.660	–	–	475	8612.660	
800	2	675	8612.680	–	–	675	8612.680	

<sup>1)</sup> A = Rail mounting distance



# Interior installation

## Rail systems

### TS installation examples with TS system rails

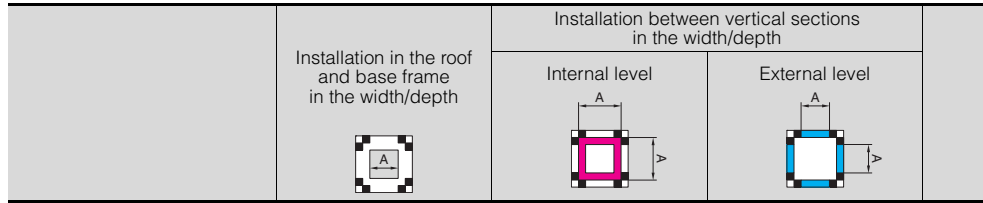

TS punched rail 25 x 38 mm (with snap-on nut M8)								
For enclosure width/depth mm	Packs of	A <sup>1)</sup> mm	Model No. TS	A <sup>1)</sup> mm	Model No. TS	A <sup>1)</sup> mm	Model No. TS	Page
500	2	–	–	435	8612.750	–	–	461
600	2	–	–	535	8612.760	–	–	
800	2	–	–	735	8612.780	–	–	

<sup>1)</sup> A = Rail mounting distance

TS punched rail 18 x 38 mm								
For enclosure width/depth mm	Packs of	A <sup>1)</sup> mm	Model No. TS	A <sup>1)</sup> mm	Model No. TS	A <sup>1)</sup> mm	Model No. TS	Page
400	2	335	8612.240	–	–	335	8612.240	462
500	2	435	8612.250	–	–	435	8612.250	
600	2	535	8612.260	–	–	535	8612.260	
800	2	735	8612.280	–	–	735	8612.280	

<sup>1)</sup> A = Rail mounting distance  
Two TS punched rails 18 x 38 mm are included in the supply of enclosures with a mounting plate. After installing the mounting plate, the TS punched rail may be inserted, as shown here.

TS support strips								
For enclosure width/depth mm	Packs of	A <sup>1)</sup> mm	Model No. TS	A <sup>1)</sup> mm	Model No. TS	A <sup>1)</sup> mm	Model No. TS	Page
400	20	–	–	–	–	325	4694.000	462
500	20	–	–	–	–	425	4695.000	
600	20	–	–	–	–	525	4696.000	
800	20	–	–	–	–	725	4697.000	
400	20	–	–	375	4309.000	–	–	
500	20	–	–	475	4596.000	–	–	
600	20	–	–	575	8800.130	–	–	
–	20	–	–	675	4598.000	–	–	
800	20	–	–	775	4579.000	–	–	
–	20	–	–	875	4599.000	–	–	

<sup>1)</sup> A = Rail mounting distance  
Alternatively, the TS support strip for the inner mounting level may also be used for mounting on the door.

PS punched rails 23 x 23 mm (for installation options, see support bracket TS/PS, angle bracket, mounting bracket)								
For enclosure width/depth mm	Packs of	A <sup>1)</sup> mm	Model No. PS	A <sup>1)</sup> mm	Model No. PS	A <sup>1)</sup> mm	Model No. PS	Page
400	12	275	4169.000	275	4169.000	–	–	463
500	12	375	4170.000	375	4170.000	–	–	
600	12	475	4171.000	475	4171.000	–	–	
800	12	675	4172.000	675	4172.000	–	–	
1000	12	875	4173.000	875	4173.000	–	–	
1200	6	1075	4174.000	1075	4174.000	–	–	
1400	6	1275	4393.000	1275	4393.000	–	–	
1600	6	1475	4175.000	1475	4175.000	–	–	
1800	6	1675	4176.000	1675	4176.000	–	–	
2000	6	1875	4177.000	1875	4177.000	–	–	
2200	6	2075	4178.000	2075	4178.000	–	–	

<sup>1)</sup> A = Rail mounting distance

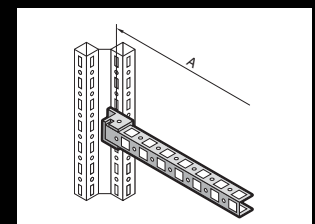
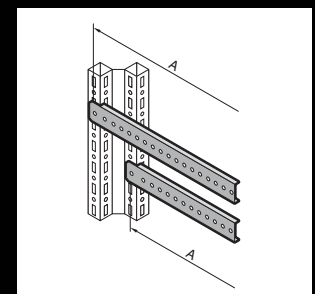
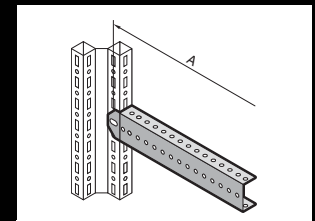
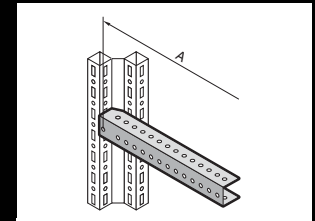

# Interior installation

## Rail systems

### TS installation examples with TS system rails

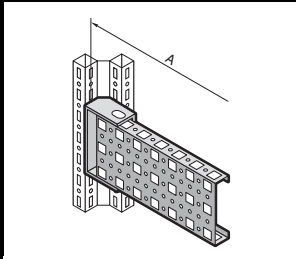
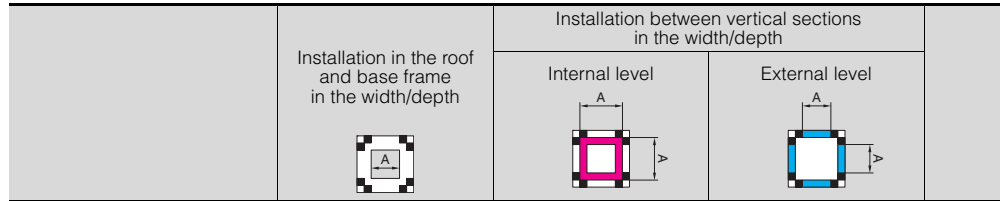

PS punched section without mounting flange 23 x 73 mm (installation option with support bracket TS)								
For enclosure width/depth mm	Packs of	A <sup>1)</sup> mm	Model No. PS	A <sup>1)</sup> mm	Model No. PS	A <sup>1)</sup> mm	Model No. PS	Page
400	4	275	4374.000	275	4374.000	-	-	464
500	4	375	4375.000	375	4375.000	-	-	
600	4	475	4376.000	475	4376.000	-	-	
800	4	675	4377.000	675	4377.000	-	-	
1000	4	875	4382.000	875	4382.000	-	-	
1200	4	1075	4378.000	1075	4378.000	-	-	
1800	4	1675	4379.000	1675	4379.000	-	-	
2000	4	1875	4380.000	1875	4380.000	-	-	
2200	4	2075	4381.000	2075	4381.000	-	-	

<sup>1)</sup> A = Rail mounting distance

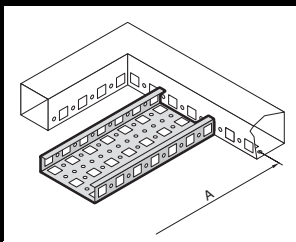

PS punched section with mounting flange 23 x 73 mm (installation options with TS adaptor rail when mounting on the vertical TS enclosure section)								
For enclosure width/depth mm	Packs of	A <sup>1)</sup> mm	Model No. PS	A <sup>1)</sup> mm	Model No. PS	A <sup>1)</sup> mm	Model No. PS	Page
400	4	335	8800.640	-	8800.640	-	-	464
500	4	435	8800.650	-	8800.650	-	-	
600	4	535	4364.000	-	4364.000	-	-	
800	4	735	4365.000	-	4365.000	-	-	
1000	4	935	4373.000	-	4373.000	-	-	
1200	4	1135	4367.000	-	4367.000	-	-	

<sup>1)</sup> A = Rail mounting distance

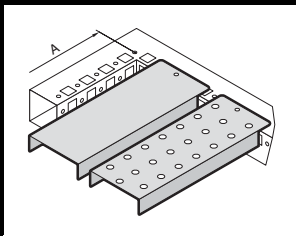
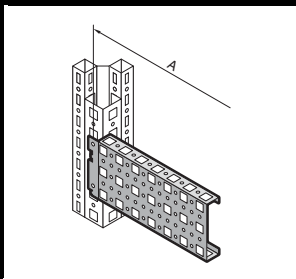

Support rails, slotted								
For enclosure width/depth mm	Packs of	A <sup>1)</sup> mm	Model No. PS	A <sup>1)</sup> mm	Model No. PS	A <sup>1)</sup> mm	Model No. PS	Page
400	4	335	4394.000	-	-	-	-	466
500	2	435	4395.000	-	-	-	-	
600	2	535	4396.000	-	-	-	-	
800	2	735	4398.000	-	-	-	-	
Support rails, unslotted								
400	4	335	-	-	-	-	-	466
500	2	435	-	-	-	-	-	
600	2	535	4396.500	-	-	-	-	
800	2	735	4398.500	-	-	-	-	

<sup>1)</sup> A = Rail mounting distance

Alternatively, the support rail (slotted and unslotted) can also be fitted with snap-on nut M8, adaptor rail or TS punched rail 25 x 38 mm on the vertical TS enclosure section.

# Interior installation

## Rail systems

### Rails for interior installation

#### for AE

For mounting in the enclosure, no machining required. Suitable for all-round mounting on the sides, base and roof areas.

Variable with 2 rows of system punchings, creates additional mounting space e.g. for:

- TS punched section with mounting flange
- Enclosure lights
- Door-operated switch
- Door stay
- Cable conduit holder

#### Material:

Sheet steel

#### Surface finish:

Zinc-plated

For enclosure depth mm	Packs of	Model No. SZ
210	4	<b>2373.210</b>
250	4	<b>2373.250</b>
300	4	<b>2373.300</b>
350	4	<b>2373.350</b>

#### Note:

Other mounting options:

- Mounting plates, locatable, TS 8612.400, see page 469.
- Mounting plates, screw-fastening, large, TS 8612.410, see page 469.
- Mounting plates, screw-fastening, small, PS 4532.000, see page 470.
- Mounting brackets, PS 4597.000, see page 470.

#### Configuration examples:

See page 452.



### Rails for interior installation

#### for CM, TP

For mounting on the existing threaded bolts. With TS system punchings on three sides.

#### Material:

Sheet steel

#### Surface finish:

Zinc-plated

#### Supply includes:

Assembly parts.

Width mm		Height mm		Packs of	Model No. CM
CM	TP <sup>1)</sup>	CM	TP <sup>2)</sup>		
600	600	–	675	4	<b>5001.050</b>
800	800	800	–	4	<b>5001.051</b>
1000	–	1000	–	4	<b>5001.052</b>
1200	1200	1200	–	4	<b>5001.053</b>
–	–	1400	–	4	<b>5001.054</b>

<sup>1)</sup> Only with TP console and desk unit (cover or rear panel/base).

<sup>2)</sup> Only with TP pedestal.

#### Configuration examples:

See page 453.



### TS punched section with mounting flange, 17 x 73 mm

Variable, with 5 rows of holes for universal skeleton structures or partial assembly. Simply locate into the TS punchings and secure.

#### Installation options:

- On the vertical TS enclosure section
  - On the outer mounting level, all-round, at the same height
  - On the inner mounting level, all-round, height-offset
- In CM and TP via rail for interior installation
  - In the depth, for outer mounting level
  - In the width, for inner mounting level

#### Material:

Sheet steel

#### Surface finish:

Zinc-plated

#### Supply includes:

Assembly screws.



#### Also required:

For installation in CM, TP:  
Rail for interior installation, see page 459.



#### Accessories:

- Screws, see page 478.
- Cable tie for fast assembly SZ 2597.000, see page 530.

#### For the outer mounting level

For enclosure width/depth mm	Packs of	Model No. TS
300	4	<b>8612.130</b>
400	4	<b>8612.140</b>
500	4	<b>8612.150</b>
600	4	<b>8612.160</b>
800	4	<b>8612.180</b>
1000	4	<b>8612.100</b>
1200	4	<b>8612.120</b>

#### For the inner mounting level

For enclosure width/depth mm	Packs of	Model No. TS
300	4	<b>8612.030</b>
400	4	<b>8612.040</b>
500	4	<b>8612.050</b>
600	4	<b>8612.060</b>
800	4	<b>8612.080</b>
1000	4	<b>8612.000</b>
1200	4	<b>8612.020</b>

#### Configuration examples:

See from page 453.

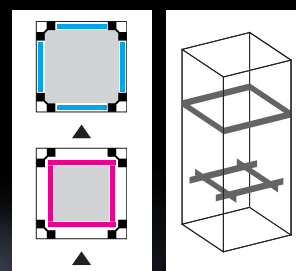
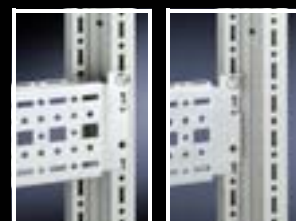

# Interior installation

## Rail systems

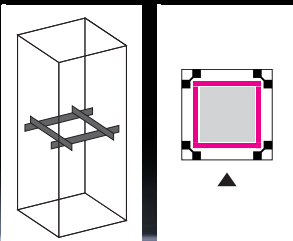
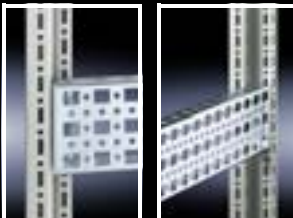
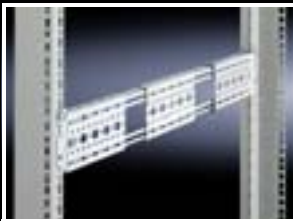

### Attachment TS

for TS punched section with mounting flange, 17 x 73 mm

#### Benefits:

- For attaching the TS punched section with mounting flange where access to installed equipment, such as mounting plates, is blocked by the screw fastening.
- May also be screw-fastened onto the punched section with mounting flange or enclosure frame and used as a support for contact hazard protection covers or master switch trim panels.

Packs of	Model No. TS
12	8612.010

#### Material:

Sheet steel

#### Surface finish:

Zinc-plated

### TS punched section with mounting flange, 17 x 73 mm

Depth-variable for mounting frames for DK-TS, TE

For designing flexible interior installation, and/or to accommodate additional built-in components. The punched sections with mounting flanges may be located in the enclosure depth between two mounting frames. An additional screw fastening secures the unit. The depth variability of the rails facilitates flexible adaptation of their length to the existing attachment distance between the two 482.6 mm (19") mounting frames. An additional punched section centre piece may be slid flexibly along the rail in the depth and secured to slots. This facilitates flexible attachment at any point between the mounting frames in the enclosure depth.

Length mm	Packs of	Model No. HP
300 – 470 <sup>1) 2)</sup>	2	7000.676
530 – 700 <sup>1)</sup>	2	7000.678

<sup>1)</sup> Distance between 482.6 mm (19") levels = length + 120 mm

<sup>2)</sup> L < 420 mm, without centre piece

#### Material:

Sheet steel

#### Surface finish:

Zinc-plated

#### Supply includes:

- 2 variable punched sections with mounting flanges
- One sliding centre part each
- Assembly parts

### TS punched section with mounting flange, 23 x 73 mm

The alternative to the TS punched section with mounting flange 17 x 73 mm, see page 459, with punchings for captive nuts/threaded blocks instead of the slotted holes top and bottom. Simply locate and secure.

#### Installation options:

- On the vertical TS enclosure section

#### Material:

Sheet steel

#### Surface finish:

Zinc-plated

#### Supply includes:

Assembly screws.

#### For the inner mounting level

For enclosure width/depth mm	Packs of	Model No. TS
500	4	8612.550
600	4	8612.560
800	4	8612.580
1000	4	8612.500
1200	4	8612.520



#### Accessories:

- Screws, see page 478.
- Threaded blocks, captive nuts, see page 477.

#### Configuration examples:

See page 456.

# Interior installation

## Rail systems

### TS punched section without mounting flanges, 45 x 88 mm

Heavy top-mounted equipment mounted directly on the internal surfaces (e.g. roof) is supported. Mounted on the side or rear, the enclosure can then be screw-fastened securely to the machine. The twin profile with 11 rows of holes offers numerous additional opportunities for interior installation.

#### Installation options:

- On the vertical and horizontal TS enclosure section

#### Material:

Sheet steel

#### Surface finish:

Zinc-plated

#### Supply includes:

Assembly parts.

#### For the inner mounting level

For enclosure width/depth mm	Packs of	Model No. TS
500	2	8612.650
600	2	8612.660
800	2	8612.680



#### Accessories:

- Screws, see page 478.
- Threaded blocks, captive nuts, see page 477.

#### Configuration examples:

See page 456.

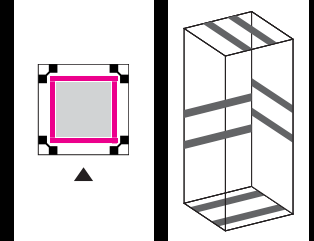

### TS punched rail 25 x 38 mm

For heavy installations, with attachment holes.

#### Installation options:

- On the vertical TS enclosure section

With 9 mm round holes on a 25 mm pitch pattern on all sides, for mounting:

- Support rails, see page 466
- System support rails, see page 466
- C rails 30/15, see page 465
- Cable clamp rails (right angle section), see page 527
- Own assemblies.

#### Material:

Sheet steel, 3.0 mm

#### Surface finish:

Zinc-plated

#### Supply includes:

Assembly screws.

For enclosure width/depth mm	Packs of	Model No. TS
500	2	8612.750
600	2	8612.760
800	2	8612.780



#### Also required:

Snap-on nut M8, TS 8800.808, see page 471.

#### Note:

In conjunction with the snap-on nut, particularly well-suited for dynamic connections.

#### Configuration examples:

See page 457.

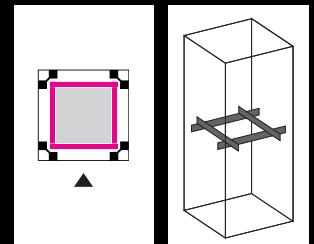
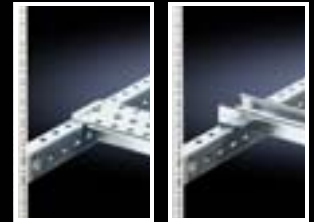

### Base configuration rail

#### for CM

For mounting in the enclosure depth, on the existing threaded bolts, no machining required. TS system punchings on 2 sides. Creates additional installation options.

#### Material:

Sheet steel

#### Surface finish:

Zinc-plated

#### Supply includes:

Assembly parts.

For enclosure depth mm	Packs of	Model No. CM
400	2	5001.370
300	2	5001.371



# Interior installation

## Rail systems

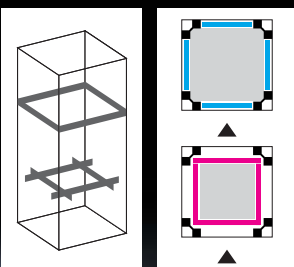
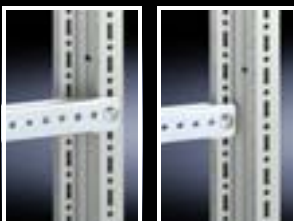
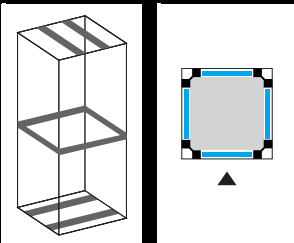

### TS punched rail 18 x 38 mm

Simply locate and secure with a screw. The location system makes assembly and dismantling easier. It only needs to be secured on one side, but may be secured on both sides if required.

#### Installation options:

- On the vertical TS enclosure section
  - On the outer mounting level
- On the horizontal TS enclosure section
- On base configuration rail for CM

#### Material:

Sheet steel

#### Surface finish:

Zinc-plated

#### Supply includes:

Assembly screws.

#### Note:

In enclosures with a mounting plate, 2 punched rails are already included with the supply.

For enclosure width/depth mm	Packs of	Model No. TS
400	4	<b>8612.240</b>
500	4	<b>8612.250</b>
600	4	<b>8612.260</b>
800	4	<b>8612.280</b>

#### + Accessories:

- Screws, see page 478.
- Cable tie for fast assembly SZ 2597.000, see page 530.
- Cable clamps, see page 529.

#### Configuration examples:

See from page 453.

### TS support strips

#### Installation options:

- On the vertical and horizontal TS enclosure section
  - On the outer mounting level, all-round, at the same height
  - On the inner mounting level, all-round, height-offset
- On the tubular door frame TS, ES
- On the perforated door strip CM, TP
- On the ES system punchings, in the enclosure depth

#### Material:

Sheet steel

#### Surface finish:

Zinc-plated

#### Supply includes:

Assembly screws.

#### For the outer mounting level

For enclosure width/depth mm	Length mm	Packs of	Model No. TS
400	340	20	<b>4694.000</b>
500	440	20	<b>4695.000</b>
600	540	20	<b>4696.000</b>
800	740	20	<b>4697.000</b>

#### + Accessories:

- Screws, see page 478.
- Cable tie for fast assembly SZ 2597.000, see page 530.

#### Configuration examples:

See from page 452.

#### For the inner mounting level and for mounting on doors

For enclosure width/depth mm	For door width mm	Length mm	Packs of	Model No. TS
–	400	290	20	<b>4594.000</b>
400	500	390	20	<b>4309.000</b>
500	600	490	20	<b>4596.000</b>
600	–	590	20	<b>8800.130</b>
–	800	690	20	<b>4598.000</b>
800	900	790	20	<b>4579.000</b>
–	1000	890	20	<b>4599.000</b>

# Interior installation

## Rail systems

### TS assembly block

Installation in the vertical TS enclosure sections for mounting PS-compatible individual components.

**Material:**

Die-cast zinc

**Supply includes:**

Assembly screws.

Packs of	<b>Model No. TS</b>
4	<b>8800.310</b>

**Possible alternative:**

Snap-on nut, see page 471.

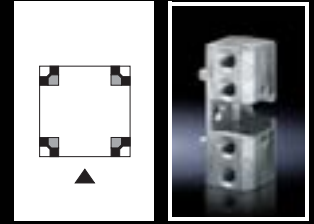

### Adaptor rail

**for PS compatibility**

Installation in the vertical TS enclosure sections (across the entire enclosure height or in sub-sections) to create compatibility with:

- PS punched rail, 23 x 23 mm
- PS punched section without mounting flange, 23 x 73 mm
- PS punched section with mounting flange 23 x 73 mm

**Material:**

Sheet steel

**Surface finish:**

Zinc-plated

**Supply includes:**

Assembly screws.

For enclosure height mm	Packs of	<b>Model No. TS</b>
1800	4	<b>8800.380</b>
2000	4	<b>8800.300</b>
2200	4	<b>8800.320</b>

**Accessories:**

Screws, see page 478.

**Possible alternative:**

Snap-on nut, see page 471.

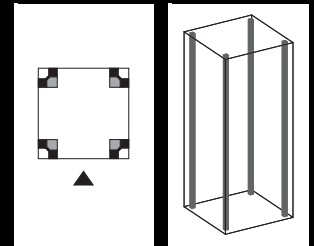
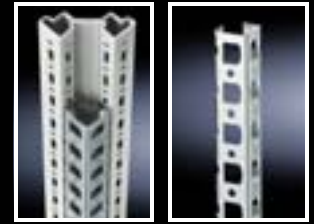

### PS punched rails 23 x 23 mm

**for TS, ES**

**Installation options:**

- On the vertical enclosure section
  - Directly via support brackets TS
  - Via adaptor rail for PS compatibility in conjunction with angle brackets, mounting brackets or support brackets PS
- On the horizontal enclosure section
  - Directly via angle brackets, mounting brackets or support brackets PS

**Material:**

Sheet steel

**Surface finish:**

Zinc-plated

Length mm	For WHD mm	Packs of	<b>Model No. PS</b>
295	400	12	<b>4169.000</b>
395	500	12	<b>4170.000</b>
495	600	12	<b>4171.000</b>
695	800	12	<b>4172.000</b>
895	1000	12	<b>4173.000</b>
1095	1200	6	<b>4174.000</b>
1295	1400	6	<b>4393.000</b>
1495	1600	6	<b>4175.000</b>
1695	1800	6	<b>4176.000</b>
1895	2000	6	<b>4177.000</b>
2095	2200	6	<b>4178.000</b>

**! Also required:**

- U nuts, see page 477.
- Mounting brackets TS/PS, see page 472 or
- Angle brackets, support brackets TS/PS, see page 473.

**+ Accessories:**

- Cable attachment, see page 530.
- Screws, see page 478.
- Cable tie for fast assembly SZ 2597.000, see page 530.

**Configuration examples:**

See from page 453.



# Interior installation

## Rail systems

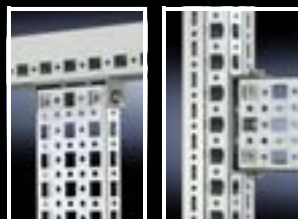

### PS punched section without mounting flange, 23 x 73 mm for TS, ES

#### Installation options:

- On the vertical enclosure section
  - Directly via support brackets TS
  - Via adaptor rail for PS compatibility in conjunction with support brackets PS
- On the horizontal enclosure section
  - Directly via support brackets PS

#### Material:

Sheet steel

#### Surface finish:

Zinc-plated

Length mm	For WHD mm	Packs of	Model No. PS
295	400	4	<b>4374.000</b>
395	500	4	<b>4375.000</b>
495	600	4	<b>4376.000</b>
695	800	4	<b>4377.000</b>
895	1000	4	<b>4382.000</b>
1095	1200	4	<b>4378.000</b>
1695	1800	4	<b>4379.000</b>
1895	2000	4	<b>4380.000</b>
2095	2200	4	<b>4381.000</b>



#### Also required:

Support brackets PS/TS, see page 473.



#### Accessories:

- Screws, see page 478.
- Cable tie for fast assembly SZ 2597.000, see page 530.
- U nuts, see page 477.

#### Configuration examples:

See page 458.

### PS punched section with mounting flange 23 x 73 mm for TS, ES

Variable, with 5 rows of holes for universal skeleton structures or partial assembly. Simply locate into the system punchings and secure.

#### Installation options:

- On the vertical TS enclosure section
  - Via adaptor rail for PS compatibility
- On the horizontal TS enclosure section
- On the ES system punchings, in the enclosure depth

#### Material:

Sheet steel

#### Surface finish:

Zinc-plated

#### Supply includes:

Assembly screws.

Installation in enclosure width/depth TS mm	Packs of	Model No. PS
400	4	<b>8800.640</b>
500	4	<b>8800.650</b>
600	4	<b>4364.000</b>
800	4	<b>4365.000</b>
1000	4	<b>4373.000</b>
1200	4	<b>4367.000</b>

Installation in enclosure depth ES, TP universal console, CS modular enclosures mm	Packs of	Model No. PS
400	4	<b>4369.000</b>
500	4	<b>4370.000</b>
600	4	<b>4371.000</b>
800	4	<b>4372.000</b>



#### Also required:

Adaptor rail for PS compatibility (when mounting on the vertical enclosure section), see page 463.

#### Configuration examples:

See page 458.



# Interior installation

## Rail systems

### C rails 30/15

to EN 60 715 for TS, ES

#### Installation options:

- On the vertical TS enclosure section
  - Via snap-on nut TS 8800.808 (Fig. 1)
  - Via adaptor rail for PS compatibility
- On the horizontal TS enclosure section (Fig. 2)
- On the ES system punchings
- On base configuration rail for CM

#### Material:

Sheet steel

#### Surface finish:

Zinc-plated

For enclosure width/depth mm	Length mm	Packs of	Model No. PS
500	455	6	4943.000
600	555	6	4944.000
800	755	6	4945.000
1000	955	6	4946.000
1200	1155	6	4947.000



#### Accessories:

- Cable clamps, see page 529.
- Support bracket or spacer, see page 474.
- Quick-assembly block, see page 474.
- Snap-on nut M8, TS 8800.808, see page 471.
- Adaptor rail, see page 463.



#### Possible alternative:

Rail for EMC shielding bracket and strain relief, see page 498.



### C rails

for DK-TS, CS Toptec

For direct mounting on the vertical enclosure section. Thanks to the universally designed attachment piece, the C rails may optionally be attached to the inner or outer level of the TS 8 frame.

#### Material:

Sheet steel

#### Surface finish:

Zinc-plated

#### Supply includes:

Assembly parts.

For enclosure width/depth mm	Length mm	Packs of	Model No. DK
400	298	4	7828.040
500	398	4	7828.050
600	498	4	7828.060
800	698	4	7828.080
1000	898	4	7828.100
1200	1098	4	7828.120



#### Accessories:

Cable clamps, see page 529.



### C rails

for DK-TS

#### Installation options:

- On the horizontal enclosure sections
- On the vertical TS enclosure section
  - Via adaptor rail for PS compatibility

#### Material:

Sheet steel

#### Surface finish:

Zinc-plated

#### Supply includes:

Assembly parts.

For enclosure width/depth mm	Length mm	Packs of	Model No. DK
400	290	6	7091.000
600	490	6	7095.000
800	690	6	7096.000
1000	890	6	7100.000
1200	1090	6	7102.000



#### Also required:

Adaptor rail for PS compatibility (when mounting on the vertical enclosure section), see page 463.



#### Accessories:

Cable clamps, see page 529.



# Interior installation

## Rail systems

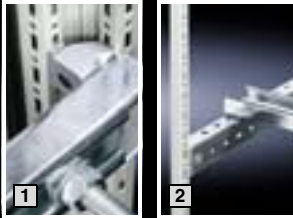

### System support rails

For heavy installed equipment such as transformers. T-head screw and slot in the support rail for any mounting position.

#### Installation options:

- On the vertical TS enclosure section
  - Via snap-on nut TS 8800.808 (Fig. 1)
  - Via adaptor rail for PS compatibility
  - Offset in the height, via TS punched rail 25 x 38 mm (Fig. 2)
- On the horizontal TS enclosure section
  - in width
  - In the depth (without mounting plate)
- On the ES system punchings
  - In the enclosure depth
- On base configuration rail for CM

#### Material:

Sheet steel

#### Surface finish:

Zinc-plated

#### Supply includes:

- 2 system support rails (45 x 25 mm)
- 4 T-head screws M12 x 60 mm
- Assembly parts

For enclosure width mm	Packs of	Model No. PS
600	2	<b>4361.000</b>
800	2	<b>4362.000</b>
1000	2	<b>4347.000</b>
1200	2	<b>4363.000</b>

#### + Accessories:

- Width divider e.g. for the installation of 2 system support rails (for 600 mm width) in 1200 mm wide enclosures, see page 376.
- Snap-on nut M8, TS 8800.808, see page 471.
- Adaptor rail, see page 463.
- TS punched rail 25 x 38 mm, see page 461.

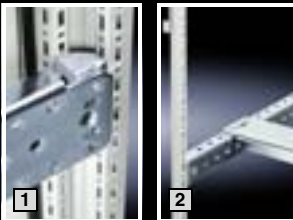
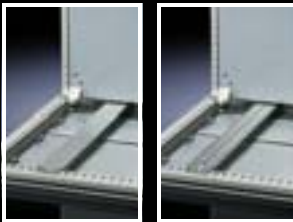

### Support rails

#### for TS, ES, CM

For heavy installations. Particularly suitable for the installation of base isolators.

#### Installation options:

- On the vertical TS enclosure section
  - Via snap-on nut TS 8800.808 (Fig. 1)
  - Via adaptor rail for PS compatibility
  - Offset in the height, via TS punched rail 25 x 38 mm (Fig. 2)
- On the horizontal TS enclosure section
  - in width
  - in depth
- On the ES system punchings, in the enclosure depth
- On base configuration rail for CM

#### Material:

Sheet steel

#### Surface finish:

Zinc-plated

#### Supply includes:

Assembly parts.

For enclosure width/depth mm	Packs of	Model No. PS	Model No. TS
		slotted	unslotted
400	4	<b>4394.000</b>	–
500	4	<b>4395.000</b>	–
600	4	<b>4396.000</b>	<b>4396.500</b>
800	4	<b>4398.000</b>	<b>4398.500</b>

#### + Accessories:

- Snap-on nut M8, TS 8800.808, see page 471.
- Adaptor rail, see page 463.
- TS punched rail 25 x 38 mm, see page 461.

#### Configuration examples:

See from page 453.



### Support rail 65 x 42 mm

#### for TS, ES

#### Benefits:

- For heavy assemblies up to 5000 N per support rail.

#### Permissible static load:

10000 N per enclosure

#### Material:

Steel

#### Surface finish:

Zinc-plated

#### Supply includes:

Assembly parts.

For enclosure width mm	Packs of	Model No. TS
600	2	<b>8612.960</b>
800	2	<b>8612.980</b>

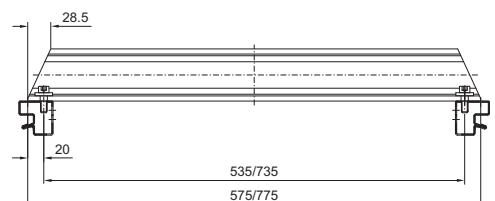

# Interior installation

## Rail systems

### Support rails TS 35/15

to EN 60 715 for TS, ES

Mounting on the TS vertical section via

- Snap-on nut M8, TS 8800.808, see page 471
- Assembly block see page 463 or
- Adaptor rail, see page 463.

For enclosure width/depth mm	Support rails length mm	Packs of	Model No. PS
500	455	6	4933.000
600	555	6	4934.000
800	755	6	4935.000
1200	1155	6	4937.000



### Support rails TS 35/7.5 and TS 35/15

to EN 60 715 for KL, KL-HD, AE

Length sized to the enclosure width

For enclosure width mm	Support rails length mm	Design	Packs of	Model No. SZ
150	137	TS 35/7.5	10	2314.000
200	187		10	2315.000
300	287		10	2316.000
400	387		10	2317.000
500	487	TS 35/15	10	2318.000
600	587		10	2319.000



### Support rails

to EN 60 715

Standard length 2 m

Design	Length	Packs of	Model No. SZ
TS 35/15	2 m	6	2313.150
TS 35/7.5	2 m	6	2313.750

### Mounting clip

for support rails

For fast, secure attachment of:

- Cable ducts
- Mounting plates
- Mounting angles

on support rail TS 35/7.5 and TS 35/15 to EN 60 715.

Simply pre-assemble the mounting clip on the part to be installed, then snap into position on the support rail.

Packs of	Model No. SZ
30	2309.000



### C rails

for EL

For infinite adjustment of the mounting angles in the depth.

**Material:**

Sheet steel

**Supply includes:**

Assembly parts.

For centre part depth mm	Packs of	Model No. EL
216	4	2238.000 <sup>1)</sup>
316	4	2239.000
416	4	2237.000

<sup>1)</sup> Extended delivery times.



**Accessories:**

Cable clamps, see page 529.

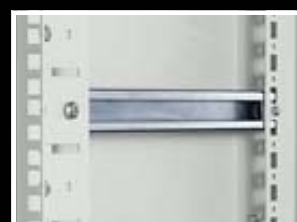

# Interior installation

## Rail systems

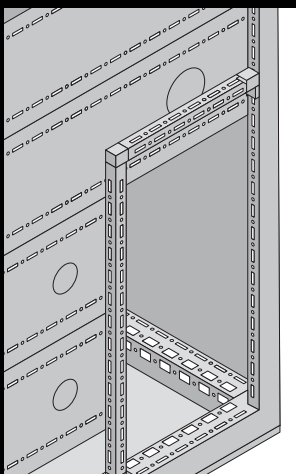
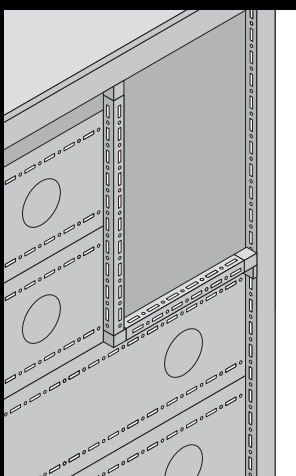

### TS punched rail 17 x 17 mm

#### for TS

Mounting angle with TS pitch on three sides.  
Suitable for

- building an auxiliary construction for dividing the busbar space,
- individual use as mounting frame for low and medium loads,
- fastening to the internal or external mounting level of the TS 8 enclosure.

#### Material:

Sheet steel, 1.5 mm

#### Surface finish:

Zinc-plated



#### Also required:

- Frame connector piece, see page 475.
- T-connector piece, see page 475.
- Corner connector, see page 475.

For horizontal busbar space separation		Packs of	Model No. SV
For functional space depth mm	Length mm		
425	62.5	12	9673.915
600	137.5	12	9673.920

For vertical separation with busbar system in the top rear section		Packs of	Model No. SV
For functional space height mm	Length mm		
450 – 500 <sup>1)</sup>	487.5	12	9673.953
650 – 800 <sup>1)</sup>	787.5	12	9673.983

<sup>1)</sup> Rails should be shortened where necessary.

For vertical separation with busbar system in the bottom rear section		Packs of	Model No. SV
For functional space height mm	Length mm		
350	412.5	12	9673.951
400	462.5	12	9673.960
450	512.5	12	9673.961
550 – 650 <sup>1)</sup>	712.5	12	9673.981
700 – 800 <sup>1)</sup>	862.5	12	9673.995

<sup>1)</sup> Rails should be shortened where necessary.

For external mounting level		Packs of	Model No. SV
For enclosure width/depth mm	Length mm		
400	262.5	12	9673.940
500	362.5	12	9673.950
600	462.5	12	9673.960

For internal mounting level		Packs of	Model No. SV
For enclosure width/depth mm	Length mm		
400	312.5	12	9673.941
500	412.5	12	9673.951
600	512.5	12	9673.961
800	712.5	12	9673.981

# Interior installation

## Rail systems

### C rails

#### for cable chamber enclosures

For attaching cables and lines and for mounting stacking insulators.

#### Material:

Sheet steel

#### Supply includes:

- 4 C rails
- 8 brackets
- Assembly parts

For TS enclosures width/depth mm	Length (L) mm	Packs of	Model No. SV
600	600	4	9660.210
800	800	4	9660.220

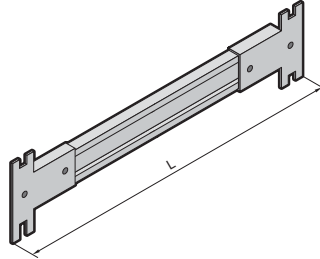

### Punched sections with mounting flanges

#### for coupling section

For assembling a Maxi-PLS or Flat-PLS busbar system directly beneath or above the circuit-breaker. This punched section with mounting flange may be used without conflict in conjunction with the compartment space side panel modules. It is attached to the outer level of the TS 8 enclosure system, but thanks to the PS punchings allows a mounting level as in the roof or base frame, thereby facilitating the use of busbar system attachment for the roof/base section.

#### Material:

Sheet steel

#### Surface finish:

Zinc-plated

#### Supply includes:

Assembly parts.

For TS enclosures width/depth mm	Packs of	Model No. SV
600	2	9674.056
800	2	9674.058



### Mounting plates

#### Locatable

on

- the vertical TS enclosure section
- TS punched section with mounting flange, 17 x 73 mm
- at the rear on the TE 482.6 mm (19") mounting frame

#### Material:

Sheet steel

#### Surface finish:

Zinc-plated

#### Supply includes:

Assembly screws.

Packs of	Model No. TS
4	8612.400

#### Detailed drawings:

Available on the Internet.

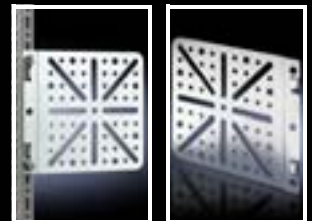

### Mounting plates

#### Screw-fastened, large

On all enclosures and mounting parts with system punchings on a 25 mm pitch pattern.

#### Material:

Sheet steel

#### Surface finish:

Zinc-plated

#### Supply includes:

Assembly screws.

Packs of	Model No. TS
4	8612.410

#### Detailed drawings:

Available on the Internet.

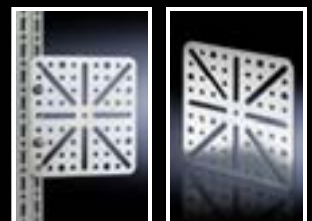

# Interior installation

## Rail systems

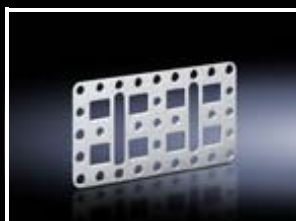

### Mounting plates

#### Screw-fastened, small

**Material:**  
Sheet steel

**Surface finish:**  
Zinc-plated

**Supply includes:**  
Assembly screws.

Packs of	Model No. PS
4	4532.000

**Detailed drawings:**  
Available on the Internet.

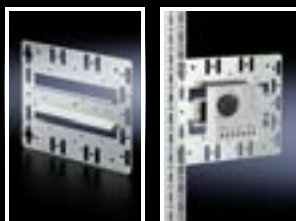

### Mounting plate TS

#### with integral top-hat rail

For direct snap-mounting of components such as speed control, enclosure internal thermostat and hygrostat.

**Material:**  
Sheet steel

**Surface finish:**  
Zinc-plated

**Supply includes:**  
Mounting plate (mounting accessories included).

Packs of	Model No. DK
1	7526.964



### Mounting bracket

May be screw-fastened onto all enclosures and mounting parts with system punchings on a 25 mm pitch pattern.

**Material:**  
Sheet steel

**Surface finish:**  
Zinc-plated

**Supply includes:**  
Assembly screws.

Packs of	Model No. PS
4	4597.000

#### Accessories:

- Screws, see page 478.
- Cable tie for fast assembly SZ 2597.000, see page 530.

**Detailed drawings:**  
Available on the Internet.



### Mounting bracket

#### for interior installation

For installing punched sections with mounting flanges and support strips in:

- Comfort Panel horizontal/vertical from 74 mm installation depth

or for installing in:

- Optipanel from an installation depth of 100 mm

**Material:**  
Sheet steel

**Surface finish:**  
Zinc-plated

**Supply includes:**  
Assembly parts.

Packs of	Model No. CP
4	6205.100

**Detailed drawings:**  
Available on the Internet.

		Comfort Panel	Page
		Front plate width 482.6 mm (19")	
Punched sections with mounting flanges	Horizontal	8612.150	459
	Vertical		
Support strips	Horizontal	4695.000	462
	Vertical		

# Interior installation

## Assembly components

### Snap-on nut TS

Metric thread for vertical TS enclosure section.  
To install, insert into slot and clip into position.  
The snap-on nut is then secure. By tightening the screw, it is securely tightened against the section, and potential equalisation is automatically created.

#### Installation options:

- On the vertical TS enclosure section
  - with metric thread M6 or M8
  - the alternative to metal screws
  - particularly well-suited for dynamically loaded connections.

#### Material:

Precision-cast stainless steel

#### Accessories for interior installation

- 1 Support rails, see page 466
- 2 Cable clamp rails, see page 527
- 3 C rails 30/15, see page 465
- 4 System support rails, see page 466
- 5 TS punched rail 25 x 38 mm, see page 461

Thread	Packs of	Model No. TS
M6	20	8800.806
M8	20	8800.808

#### + Accessories:

Multi-tooth screw M6 x 12 or M8 x 12, see page 478.



### Adaptor bracket TS

For external mounting of

- System lights
- Cable ducts

on the vertical TS enclosure section.

#### Material:

Sheet steel

#### Surface finish:

Zinc-plated

#### Supply includes:

Assembly screws.

Packs of	Model No. TS
6	8800.360



# Interior installation

## Assembly components



### Mounting bracket TS

Offers variable mounting options for the punched rail 23 x 23 mm, e.g. for supporting external surfaces or creating an additional internal level.

**Material:**

Die-cast zinc

**Supply includes:**

24 screws 5.5 x 13 mm.

Packs of	Model No. TS
24	8800.370

**+** **Accessories:**

U nuts (recommendation: M6), see page 477.

**Installation options:**

- On the vertical TS enclosure section
  - flush with the outer edge of the enclosure or
  - flush with the enclosure clearance width.

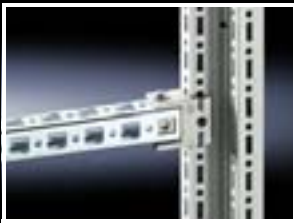

- 1** Support of the external surfaces with two mounting options:

- Without mounting plate (photo)
- With mounting plate (drawing)

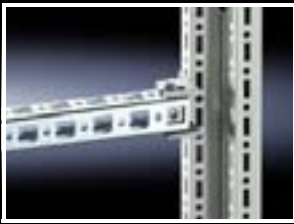
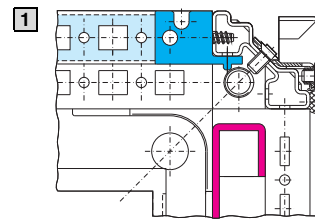

Two installation options for the inner mounting level:

- 2** If there is no divider panel fitted.

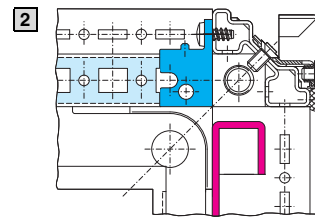

- 3** With a divider panel fitted, and without or with a mounting plate in a set forward position.

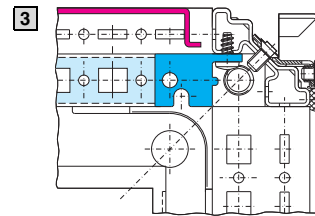

### Mounting bracket PS

For variable attachment of punched rail 23 x 23 mm.

**Installation options:**

- Optionally flush with:
  - Outer enclosure edge or
  - Enclosure clearance width
- On the vertical TS enclosure section via
  - Adaptor rail for PS compatibility, see page 463
- On the horizontal TS enclosure section
- On enclosures and rails with rectangular system punching 12.5 x 10.5 mm.

**Material:**

Die-cast zinc

**Supply includes:**

1 set =  
1 mounting bracket,  
1 screw M6 x 12 mm,  
1 cage nut M6.

Packs of	Model No. PS
24 set	4182.000

**!** **Also required:**

- U nuts for punched rails (recommended: M6), see page 477.
- Multi-tooth screws M6 x 12 mm, see page 478.



# Interior installation

## Assembly components

### Angle bracket PS

For quick attachment of punched rails  
23 x 23 mm.

#### Installation options:

- On the vertical TS enclosure section via
  - Adaptor rail for PS compatibility, see page 463
- On the horizontal TS enclosure section
- On enclosures and rails with rectangular system punching 12.5 x 10.5 mm.

#### Material:

Sheet steel

#### Surface finish:

Zinc-plated

#### Supply includes:

- 1 set =  
1 angle bracket, left,  
1 angle bracket, right,  
2 metal screws 5.5 x 13 mm.

Packs of	Model No. PS
12 set	4181.000



#### Also required:

- U nuts for punched rails (recommended: M6), see page 477.
- Multi-tooth screws M6 x 12 mm, see page 478.



### Support bracket TS

For the attachment of punched sections without mounting flange 23 x 73 mm or punched rails 23 x 23 mm.

#### Installation options:

- On the vertical TS enclosure section
  - on a 25 mm pitch pattern
  - in 2 mm increments.

#### Material:

Die-cast zinc

#### Supply includes:

- 1 set =  
1 support bracket,  
1 stay,  
3 metal screws 5.5 x 13 mm.

Packs of	Model No. TS
6 set	8800.330



#### Also required:

- U nuts for punched rails (recommended: M6), see page 477.
- Multi-tooth screws M6 x 12 mm, see page 478.



### Support bracket PS

For the attachment of punched sections without mounting flange 23 x 73 mm or punched rails 23 x 23 mm.

#### Installation options:

- On the vertical TS enclosure section via
  - Snap-on nut TS 8800.806, see page 471 or
  - Adaptor rail for PS compatibility, see page 463
- On the horizontal TS enclosure section
- On enclosures and rails with rectangular system punching 12.5 x 10.5 mm.

#### Material:

Die-cast zinc

#### Supply includes:

- 1 set =  
1 support bracket,  
2 countersunk screws,  
2 serrated lock washers.

Packs of	Model No. PS
24 set	4183.000



#### Also required:

- U nuts for punched rails (recommended: M6), see page 477.
- Multi-tooth screws M6 x 12 mm, see page 478.
- Adaptor rail for PS compatibility (when mounting on the vertical enclosure section), see page 463.

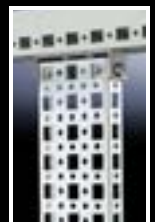

# Interior installation

## Assembly components

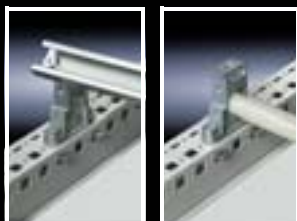

### Bracket/spacer

For fastening C rails, punched rails or cable clamp rails (angle section). On the sides, to accommodate square sections or tubes (Ø 20 mm).

Attachment points with M8 thread.

#### Installation options:

- On the vertical TS enclosure section via
  - Snap-on nut TS 8800.808, see page 471, or
  - Adaptor rail for PS compatibility, see page 463
- On the horizontal TS enclosure section
- On enclosures and rails with rectangular system punching 12.5 x 10.5 mm.

#### Material:

Die-cast zinc

#### Supply includes:

- 1 set =
- 1 bracket/spacer,
  - 2 screws M8 x 16 mm,
  - 2 spring lock washers,
  - 2 cage nuts M8,
  - 2 serrated lock washers,
  - 2 metal screws.

Packs of	Model No. TS
6 set	4199.000

#### Accessories:

Angle piece TS 4134.000, see page 474.

### Quick-assembly block

For a variety of installation options.

#### Installation options:

- On the vertical TS enclosure section via
  - Snap-on nut TS 8800.808, see page 471, or
  - Adaptor rail for PS compatibility, see page 463
- On the horizontal TS enclosure section
- On enclosures and rails with rectangular system punching 12.5 x 10.5 mm.

#### Material:

Die-cast zinc

#### Supply includes:

- 12 quick-assembly blocks
- 12 threaded blocks M8
- 24 screws M8 x 12 mm
- 24 square nuts M8

Packs of	Model No. TS
12	4133.000

### Angle piece

For assembling punched rails and mounting surfaces with a 45° incline.

#### Installation options:

- On the vertical TS enclosure section via
  - Snap-on nut TS 8800.806, see page 471 or
  - Adaptor rail for PS compatibility, see page 463
- On the horizontal TS enclosure section
- On enclosures and rails with rectangular system punching 12.5 x 10.5 mm.

#### Material:

- Angle pieces: Die-cast zinc
- Insulating pieces: Plastic

#### Supply includes:

- 1 set =
- 1 angle piece,
  - 1 insulating piece,
  - 1 insulating screw,
  - 2 assembly screws,
  - 1 threaded block M6.

Packs of	Model No. TS
12 set	4134.000

# Interior installation

## Assembly components

### Frame connector piece

#### for TS punched rail 17 x 17 mm

Mounting part with integral M4 threads for attaching the TS punched rail 17 x 17 mm to the horizontal and vertical TS frame section (external level). The frame adaptor piece can be used as a self-holding construction aid in the TS pitch and fastened with a screw to the frame. Can also be used for fastening other sections with TS pitch.

**Material:**

Die-cast zinc

**Supply includes:**

Assembly parts.

Packs of	Model No. SV
24	9673.901



### T-connector piece

#### for TS punched rail 17 x 17 mm

Mounting piece with integral M4 threaded holes for attaching the TS punched rail 17 x 17 mm

- to horizontal and vertical TS chassis
  - to TS punched rail 17 x 17 mm
  - to the vertical TS frame section (internal level).
- The T-connector piece can be used as a self-holding construction aid in the TS pitch and fastened with a screw to the frame. Can also be used for fastening other sections with TS pitch.

**Material:**

Die-cast zinc

**Supply includes:**

Assembly parts.

Packs of	Model No. SV
24	9673.903



### Corner connector

#### for TS punched rail 17 x 17 mm

Mounting part with integral M4 threads for connecting two TS punched rails 17 x 17 mm at an angle of 90° across the corner. Required for building the auxiliary construction for the busbar space separation.

**Material:**

Die-cast zinc

**Supply includes:**

Assembly parts.

Packs of	Model No. SV
10	9673.902



# Interior installation

## Assembly components



### Universal bracket

For installing

- Enclosure lights in
  - Compact enclosures AE
- Door-operated switches in
  - Compact enclosures AE
  - TopConsole system TP
- Cable conduit holders SZ 2593.000 and SZ 2591.000 in
  - Compact enclosures AE
- Support rails for terminals in
  - Command panels and command panel housings with door.

Mounting screws are concealed when the door is closed. Existing holes for mounting blocks or hinges may be used with AE.

#### Material:

Sheet steel, zinc-plated

#### Supply includes:

Assembly parts.

Packs of	Model No. SZ
6	2373.000

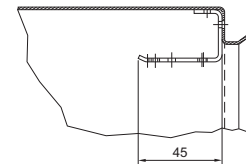
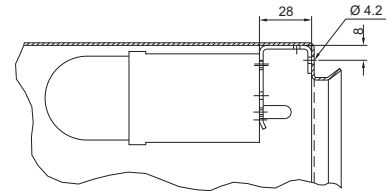

### Rail mounting bracket

For individual rail mounting.

#### Material:

Sheet steel, zinc-plated

Rail mounting bracket	Packs of	Model No. SZ
flat	20	2365.000
inclined	20	2366.000

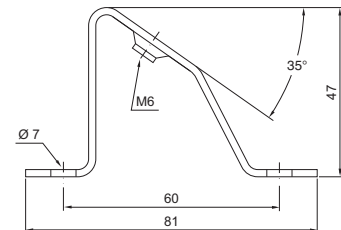
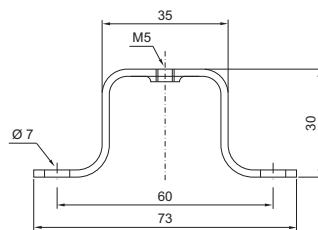

### Mounting block for AE

for AE

As an accessory for additional interior installation, e.g. mounting of cable ties, PS punched rails, top hat rails and C rails (e.g. for a second pair of mounting angles).

#### Supply includes:

Assembly parts.

Packs of	Model No. SZ
20	2574.000

# Interior installation

## Assembly components

### U nuts

For

- Punched rail 23 x 23 mm
- Punched section without mounting flange, 23 x 73 mm
- Punched section without mounting flange, 45 x 88 mm
- Punched section with mounting flange, 23 x 73 mm

For mounting punched rails and punched sections without mounting flanges on angle brackets, mounting brackets and support brackets, we recommend U nuts with M6 thread (PS 4179.000).

Thread	Packs of	Model No. PS
M4	20	<b>4119.000</b>
M5	20	<b>4157.000</b>
M6	20	<b>4179.000</b>
M8	20	<b>4180.000</b>



#### Accessories:

Multi-tooth screws M6 x 12 mm, (for PS 4179.000), see page 478.



### Captive nuts/threaded blocks

#### Installation options:

On enclosures and rails with rectangular system punching 12.5 x 10.5 mm, such as:

- TS enclosure section
  - vertically, via adaptor rail for PS compatibility
  - horizontally, direct
- ES enclosure body, all-round
- Punched rail 23 x 23 mm
- Punched section without mounting flange, 23 x 73 mm
- Punched section without mounting flange, 45 x 88 mm
- Punched section with mounting flange, 23 x 73 mm



#### Possible alternative:

On the vertical TS enclosure section TS snap-on nuts, see page 471.

### Captive nuts

The compression spring, designed as an insertion aid, ensures reliable mechanical and electrical connection in the system punchings.

Thread	Packs of	Model No. TS
M5	50	<b>4166.000</b>
M6	50	<b>4164.000</b>
M8	50	<b>4165.000</b>

### Threaded block

With snap-off insertion aid, die-cast zinc.

Thread	Packs of	Model No. TS
M6	50	<b>4162.000</b>
M8	50	<b>4163.000</b>

### Captive nuts

The nuts are inserted from the same side as screw-fastening takes place. Consequently, attachment points in the same height or width may also be used around corners. The spring cage also ensures electrical connection in the system punchings.

Thread	Packs of	Model No. TS
M6	50	<b>8800.340</b>
M8	50	<b>8800.350</b>



# Interior installation

## Assembly components



### Spring nut M5

For

- Comfort Panel from an installation depth of 74 mm
- Optipanel from an installation depth of 100 mm
- Compact Panel

The spring ensures reliable protection against unintentional displacement.

Further interior installation, e.g. with mounting bracket PS 4597.000 (see page 470) or mounting bracket CP 6205.100 (see page 470).

#### Material:

Sheet steel, zinc-plated

Packs of	Model No. CP
50	<b>6108.000</b>



### Threaded inserts M6

for KS

For securing installed equipment to the moulded bosses in the door and in the enclosure rear panel.

Screw length available for insertion: 8 mm.

Packs of	Model No. KS
20	<b>1482.000</b>



### Multi-tooth screws

M6 x 12 to fit:

- Snap-on nuts (TS 8800.806)
- U nuts for punched rails (PS 4179.000)
- Captive nuts (PS 4164.000)
- Threaded blocks (TS 4162.000)

M8 x 12 to fit:

- Snap-on nuts (TS 8800.808)

Multi-tooth drive for optimum transmission of torques, an extended tool life and increased safety and reliability when tightening and loosening screw connections.

Type of screw	Dimensions mm	Packs of	Model No. SZ
Multi-tooth screws	M6 x 12	300	<b>2504.500</b>
	M8 x 12	300	<b>2504.800</b>
Metal multi-tooth screws	5.5 x 13	300	<b>2486.500</b>
Metal multi-tooth screws for stainless steel	5 x 13	300	<b>2486.300</b>
Self-tapping screws:			
• Hex screws	M5 x 10	500	<b>2504.000</b>
	M5 x 12	500	<b>2488.000</b>
• Posidrive raised countersunk screws			
• Pan-head screws, posidrive	M5 x 12	500	<b>2489.000</b>
• Multi-tooth pan-head screws	M5 x 12	500	<b>2489.500</b>
Self-tapping screws	ST 4.8 x 16	300	<b>2487.000</b>



### Metal multi-tooth screws

For the round holes 4.5 mm diameter in the enclosure section, punched rails and punched sections without mounting flanges.



### Self-tapping screws

For the round holes 4.5 mm diameter in the enclosure section, punched rails and punched sections without mounting flanges.



### Self-tapping screws

Mark, drill and tighten in a single operation using electric or pneumatic tools.

For metal thickness: 0.8 – 3 mm

Length: 16 mm

Usable length: 9.5 mm

Width across flats: 8 mm

# Interior installation

## Assembly components

### TS adaptor for wiring systems

Adaptor rail for the Lütze LSC wiring system.

**Supply includes:**

1 set =  
6 adaptor rails,  
24 spring lock washers,  
24 metal screws 5.5 x 13 mm.

**Note:**

Mounting parts for the LCS wiring system not included with the supply.

For enclosure depth mm	Packs of	Model No. TS
500	1 set	8800.150
600		8800.160
800		8800.180



### Installation kit for the Moeller MR 25 wiring system.

**Supply includes:**

1 set =  
2 baying clamps,  
4 mounting rails, assembly parts.

For enclosure depth mm	Packs of	Model No. TS
400	1 set	8800.240



### Kit

**for separate frame TS**

Every TS 8 frame is easily converted to a rack suitable for dismantling. To this end, the frame sections in the roof and base frame are separated, optionally in the width or depth. The four connection components are inserted into the frame section and screw-fastened. The external dimensions of the frame remain unchanged.

**Supply includes:**

Assembly parts.

**Note:**

The maximum achievable IP protection category is restricted by separation of the frame.

Packs of	Model No. DK
4	7829.400



# Interior installation

## Component shelves for frame attachment

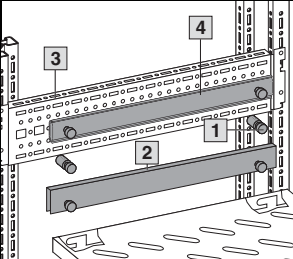

- 1** Fastening bolts
- 2** Mounting rails
- 3** Installation kit
- 4** Telescopic slides

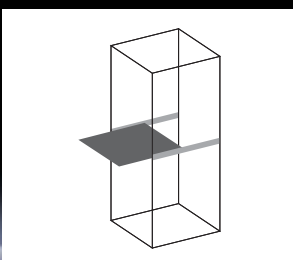
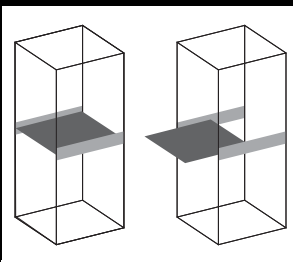

### Component shelf for frame attachment

**Enclosure width 600 and 800 mm for TS**  
For installation in enclosures **without** 482.6 mm (19") accommodation.

Max. depth of component shelves =  
Enclosure depth – 100 mm.

#### Technical specifications:

- Mounting bolts or mounting rails may be installed on a 25 mm pitch pattern in the enclosure depth.
- Mounting hole for handles provided.

**Material:**  
Sheet steel

**Colour:**  
RAL 7035

**Supply includes:**  
Assembly parts.

#### Enclosure width 600 mm

Load capacity kg (static surface load)	50	50	50	50	100	100	100	100
Component shelf depth mm	400	500	600	700	400	500	600	700
Component shelf height mm	29	29	29	29	45	45	45	45
<b>Model No. DK, slotted</b>	<b>7164.035</b>	<b>7165.035</b>	<b>7166.035</b>	<b>7166.735</b>	<b>7464.035</b>	<b>7465.035</b>	<b>7466.035</b>	<b>7466.735</b>
<b>Model No. DK, unslotted</b>	<b>7264.035</b>	<b>7265.035</b>	<b>7266.035</b>	–	–	–	–	–

#### Enclosure width 800 mm

Load capacity kg (static surface load)	50	50	50	50	100	100	100	100
Component shelf depth mm	400	500	600	700	400	500	600	700
Component shelf height mm	29	29	29	29	45	45	45	45
<b>Model No. DK, slotted</b>	<b>7184.035</b>	<b>7185.035</b>	<b>7186.035</b>	<b>7186.735</b>	<b>7484.035</b>	<b>7485.035</b>	<b>7486.035</b>	<b>7486.735</b>

#### ! Also required:

TS punched section with mounting flange, 17 x 73 mm, as installation kit for enclosure depth, see page 459	500	8612.050	8612.050	8612.050	8612.050	8612.050	8612.050	8612.050	8612.050
	600	8612.060	8612.060	8612.060	8612.060	8612.060	8612.060	8612.060	8612.060
	800	8612.080	8612.080	8612.080	8612.080	8612.080	8612.080	8612.080	8612.080
	1000	8612.000	8612.000	8612.000	8612.000	8612.000	8612.000	8612.000	8612.000
	1200	8612.020	8612.020	8612.020	8612.020	8612.020	8612.020	8612.020	8612.020

#### + Accessories:

Telescopic slides, see page 489	7061.000	7081.000	7161.000	7161.700	7064.000	7065.000	7066.000	7066.700
Handles for component shelves, see page 490	3636.010	3636.010	3636.010	3636.010	3636.010	3636.010	3636.010	3636.010
Hinged cable support	see page 490							

### Component shelf, pull-out for TS, PC-TS, IW

For direct mounting on the vertical TS enclosure section.

**Load capacity:**  
40 kg surface load, static

**Material:**  
Sheet steel

**Colour:**  
RAL 7015

**Supply includes:**  
2 telescopic slides.

For enclosures <sup>1)</sup>		Support area		Model No. IW
Width mm	Depth mm	Width mm	Depth mm	
600	600	465	545	<b>6902.960<sup>2)</sup></b>
600	800	465	745	<b>6902.980</b>

<sup>1)</sup> For enclosures without a mounting plate.

<sup>2)</sup> May also be installed in 800 mm deep enclosures based on TS (pull-out rear attachment).



# Interior installation

## Component shelves for frame attachment

### Component shelf, static installation

#### for TS

Locate the mounting pieces in the frame and attach the component shelf. Attachment in the TS enclosure section offers the greatest possible support surface.

#### Dimensions:

- Height: 25 mm
- Width: Enclosure width minus 44 mm
- Depth: Enclosure depth minus 44 mm

#### Load capacity:

75 kg surface load, static

#### Material:

Sheet steel

#### Colour:

RAL 7035

#### Supply includes:

Assembly parts.

For enclosures		Model No. DK
Width mm	Depth mm	
600	600	<b>7828.660</b>
600	800	<b>7828.680</b>
600	1000	<b>7828.600<sup>1)</sup></b>
800	600	<b>7828.680</b>
800	800	<b>7828.880</b>
800	1000	<b>7828.800</b>

<sup>1)</sup> Extended delivery times.

#### Note:

- Combined use with vertically divided doors is not possible.
- Not suitable for combination with telescopic slides.

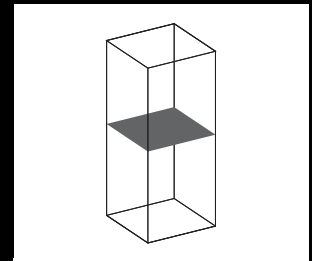
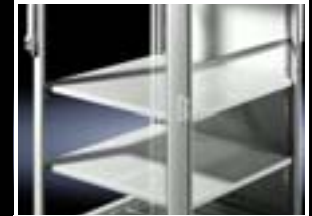

### Component shelf, static installation

#### for TS, PC-TS, IW

#### prepared for fan expansion kit

For direct mounting on the vertical TS enclosure section. Simply located into 4 pre-fitted screws and secure.

#### Load capacity:

40 kg surface load, static

#### Material:

Sheet steel

#### Colour:

RAL 7015

#### Supply includes:

Assembly parts.

For enclosures <sup>1)</sup>		Support area		Model No. PC
Width mm	Depth mm	Width mm	Depth mm	
600	600	507	550	<b>8800.900</b>
600	800	507	750	<b>8800.910</b>

<sup>1)</sup> For enclosures without a mounting plate.



#### Accessories:

Fan expansion kit DK 7980.XXX, see page 222.

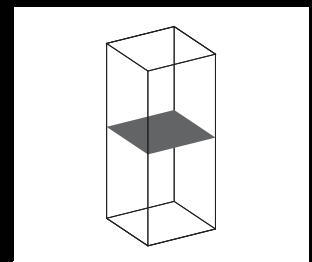

### Drawer tray

#### pull-out

For enclosures with TS frame construction in series IW, PC-TS. Width 600 mm and depth 600 – 800 mm. Tray height: 83 mm

#### Load capacity:

40 kg surface load, static

#### Material:

Sheet steel

#### Colour:

RAL 7035

#### Supply includes:

2 telescopic slides.

Packs of	Model No. IW
1	<b>6902.700</b>



# Interior installation

## Component shelves for attachment to the 482.6 mm (19") section

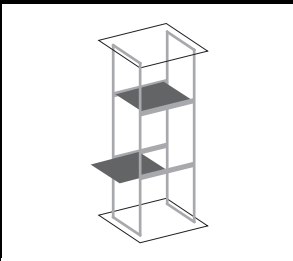
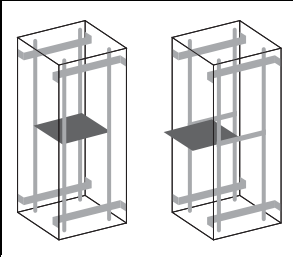

### Component shelf, 482.6 mm (19") installation

#### Enclosures with two 482.6 mm (19") mounting levels

Depending on their depth, the component shelves have several attachment points, so the distance between the 482.6 mm (19") mounting angles is variable within certain limits. Each component shelf secured in this way can be retrospectively upgraded to full withdrawal using telescopic slides. For this purpose, the telescopic slides are screw-fastened in place of the spacers.

**Load capacity:**  
50 kg surface load, static

**Material:**  
Sheet steel

**Supply includes:**  
Assembly parts.

#### ! Also required:

- Adaptor for L-shaped mounting angles TS, see page 488.
- Installation kit, depth-variable, for installation on mounting frames and L-shaped mounting angles, see page 488.

#### ⇄ Possible alternative:

Component shelves, heavy-duty, for 482.6 mm (19") installation, see page 483 – 484.

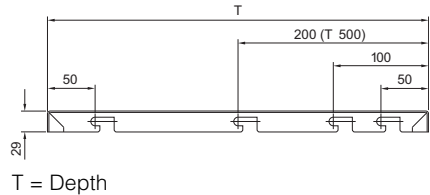

Component shelf width mm	409	409	409	409	409	409	409	409
Component shelf depth mm	300	400	500	600	700	500	600	700
Distance between levels (X)	298	348/398	348/448/498	448/548/598	548/648/698	348/448/498	448/548/598	548/648/698
Colour	RAL 7035	■	■	■	■	■	■	■
	RAL 9005	-	-	-	-	-	■	■
<b>Model No. DK</b>	<b>7143.035</b>	<b>7144.035</b>	<b>7145.035</b>	<b>7145.635</b>	<b>7145.735</b>	<b>7145.005</b>	<b>7145.605</b>	<b>7145.705</b>

#### + Accessories:

Telescopic slides for 50 kg, see page 489	7051.000	7061.000	7081.000	7161.000	7161.700	7081.000	7161.000	7161.700
Handles for component shelf, see page 490	3636.010	3636.010	3636.010	3636.010	3636.010	3636.010	3636.010	3636.010
Hinged cable support	see page 490							

#### For TS: Note for installation in network enclosures based on TS, cranked mounting angle:

The component shelves are mounted on the sides of the 482.6 mm (19") cranked mounting angles with spacers on a U pitch pattern.

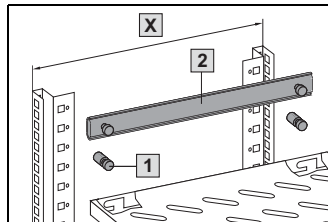

#### For TS: Note for installation in network enclosures based on TS, L-shaped mounting angle:

If L-shaped mounting angles are used, adaptor DK 7827.300 is required, see page 488.

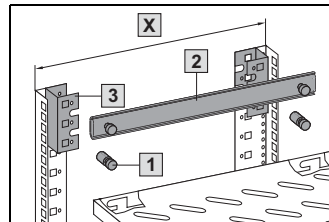

#### For TE, TS, 482.6 mm (19") system punchings: Note for installation between two mounting frames or L-shaped mounting angles:

May be mounted directly on the 482.6 mm (19") system punchings using the depth-variable installation kit, see page 488.

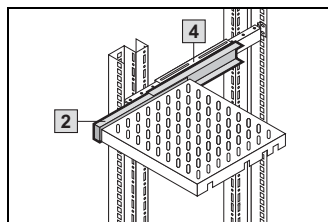

- 1 Spacers
- 2 Telescopic slides
- 3 Adaptor
- 4 Installation kit, depth-variable
- X Distance between angles

# Interior installation

## Component shelves for attachment to the 482.6 mm (19") section

### Component shelf, static installation

#### on the 482.6 mm (19") mounting frame for TE, TS

The component shelf is attached directly to the front and rear 482.6 mm (19") mounting angles.

**Load capacity:**

30 kg surface load, static

**Material:**

Sheet steel

**Colour:**

RAL 7035

**Supply includes:**

Assembly parts.

Width mm	Height mm	Depth mm	Distance between 482.6 mm (19") levels mm	Model No. DK
511	22	413	495	<b>7000.620</b>

**Note:**

Not suitable for combination with telescopic slides.

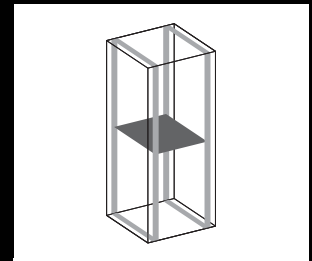
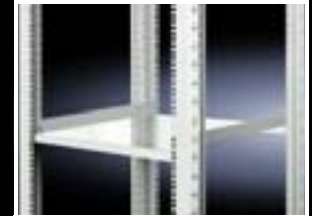

### Component shelf, heavy-duty

#### for network enclosures TS with cranked mounting angles

For static installation between two 482.6 mm (19") mounting levels.

The component shelf is located directly onto the cranked mounting angles.

**Zinc-plated version:**

**Load capacity:**

75 kg surface load, static

**Material:**

Sheet steel

**Surface finish:**

Zinc-plated

**Supply includes:**

Assembly parts.

**Zinc-plated version:**

Dimensions			Distance between levels (X) mm	Model No. DK
Width mm	Height mm	Depth mm		
452.5	20	478	498	<b>7828.950</b>
452.5	20	578	598	<b>7828.960</b>
452.5	20	678	698	<b>7828.970</b>

**Spray-finished version:**

Dimensions			Distance between levels (X) mm	Model No. DK
Width mm	Height mm	Depth mm		
453	44	470	498	<b>7145.535</b>

**Note:**

Not suitable for combination with telescopic slides.



**Possible alternative:**

Component shelf, heavy-duty, for 482.6 mm (19") configuration, see page 484, may be combined with telescopic slides, see page 489.

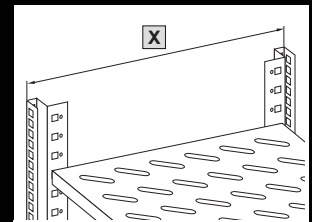
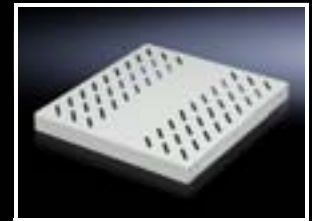

# Interior installation

## Component shelves for attachment to the 482.6 mm (19") section

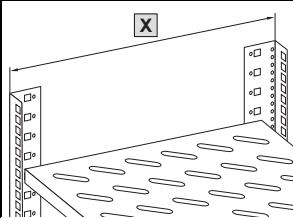
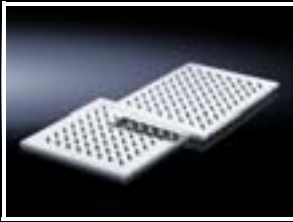

### Component shelf, heavy-duty for network enclosures TS with L-shaped mounting angles

For static installation between two 482.6 mm (19") mounting levels. The component shelf is located directly onto the **L-shaped** mounting angles.

**Load capacity:**  
75 kg surface load, static

**Material:**  
Sheet steel

**Surface finish:**  
Zinc-plated

**Supply includes:**  
Assembly parts.

Dimensions			Distance between levels (X) mm	Model No. DK
Width mm	Height mm	Depth mm		
507.5	20	480	498	<b>7828.951</b>
507.5	20	580	598	<b>7828.961</b>
507.5	20	680	698	<b>7828.971</b>

**Note:**  
Not suitable for combination with telescopic slides.

**Possible alternative:**

Component shelf, heavy-duty, for 482.6 mm (19") configuration, see page 484, may be combined with telescopic slides, see page 489.

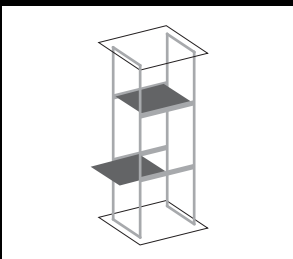
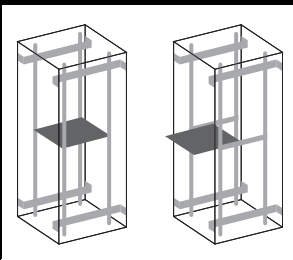

### Component shelf, heavy-duty

**482.6 mm (19") for TE, TS**

- L-shaped mounting angles
- Mounting frame 482.6 mm (19")

**Load capacity:**  
100 kg surface load, static

**Material:**  
Sheet steel

**Supply includes:**  
Assembly parts.

**Colour: RAL 7035**

Width mm	Height mm	Depth mm	Model No.
409	45	500	<b>7063.895</b>
409	45	700	<b>7063.897</b>

**Colour: RAL 9005**

Width mm	Height mm	Depth mm	Model No.
409	45	500	<b>7063.835<sup>1)</sup></b>
409	45	700	<b>7063.837</b>

<sup>1)</sup> Extended delivery times.

**Also required:**

Installation kit, depth-variable DK 7063.890, see page 488.

**Accessories:**

- Telescopic slides (100 kg) for 482.6 mm (19") component shelf, see page 489.
- Handles for component shelf, see page 490.

# Interior installation

## Component shelves for attachment to the 482.6 mm (19") punchings

### Component shelf 2 U

#### 482.6 mm (19") for 482.6 mm (19") system punchings

Suitable for installation in all enclosures with only one 482.6 mm (19") recess and all swing frames with flange mounting, 482.6 mm (19").

#### Load capacity:

25 kg surface load, static

#### Material:

Sheet steel

#### Colour:

RAL 7035

#### Supply includes:

Assembly parts.

Width mm	Depth mm	Model No. DK
390	300	7148.035



#### Accessories:

- Telescopic slides for component shelf, see page 489.
- Handles for component shelf, see page 490.

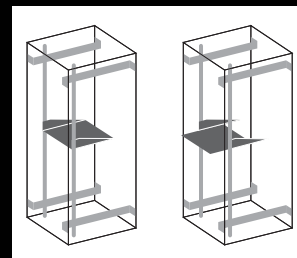

### Component shelf 1 U, depth-variable

#### 482.6 mm (19") for 482.6 mm (19") system punchings

For mounting between the front and rear 482.6 mm (19") levels. The component shelf is infinitely depth-adjustable from 488 mm to 750 mm.

#### Load capacity:

50 kg surface load, static

#### Material:

Sheet steel

#### Colour:

RAL 7035

Distance between levels mm	Model No. VR
488 – 750	3861.580

#### Note:

Not suitable for combination with telescopic slides.



### Component shelf 1/2 U, depth-variable

#### 482.6 mm (19") for 482.6 mm (19") system punchings

For mounting between the front and rear 482.6 mm (19") levels. The component shelf is infinitely depth-adjustable from 488 mm to 750 mm.

#### Load capacity:

50 kg surface load, static

#### Material:

Sheet steel

Distance between levels mm	Colour	Model No. DK
400 – 600	RAL 7035	7063.710
600 – 900	RAL 7035	7063.720
600 – 900	RAL 9005	7063.725

#### Note:

Not suitable for combination with telescopic slides.



# Interior installation

## Component shelves for attachment to the 482.6 mm (19") punchings

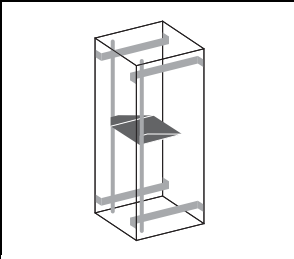

### Component shelf, complete set, pull-out

#### 482.6 mm (19") for 482.6 mm (19") system punchings

Tailored to the distance between levels in enclosures as per their supplied state of 495 mm, this complete set contains a vented component shelf, telescopic slides and a mounting kit for direct attachment.

The mounting kit also offers depth-variable attachment within 395 – 645 mm on a 25 mm pitch pattern.

**Load capacity:**  
50 kg, static

**Material:**  
Base: Sheet steel

**Surface finish:**  
– Base: Spray-finished  
– Mounting kit/telescopic slides: Zinc-plated

**Colour:**  
RAL 7035

**Supply includes:**  
– 1 component shelf  
– Telescopic slides  
– Installation kit

Base depth mm	Packs of	Model No. DK
500	1 set	7000.625

#### Accessories:

Handles for component shelf, see page 490.

### Component shelf 1 U, static installation

#### 482.6 mm (19")/535 mm (metric) for 482.6 mm (19") system punchings

The ideal support surface for small active components such as modems or mini-hubs in 482.6 mm (19") or metric levels.

**Load capacity:**  
10 kg surface load, static

**Material:**  
Sheet steel

**Colour:**  
RAL 7035

Component shelf depth mm	Model No. DK	
	482.6 mm (19")	Metric
140	7119.140	7119.155 <sup>1)</sup>

<sup>1)</sup> Extended delivery times.

**Note:**  
Not suitable for combination with telescopic slides.

#### Also required:

- Captive nuts, see page 477.
- Screws, see page 478.

# Interior installation

## Component shelves for attachment to the 482.6 mm (19") punchings

### Component shelf 2 U, static installation

#### 482.6 mm (19")/535 mm (metric) for 482.6 mm (19")/metric system punchings

If only one 482.6 mm (19") or metric mounting level is available for mounting a component shelf, this variant offers a particularly cost-effective solution.

#### Load capacity:

25 kg surface load, static

#### Material:

Sheet steel

#### Colour:

RAL 7035

#### Note:

Not suitable for combination with telescopic slides.

Component shelf depth mm	482.6 mm (19")	Metric	Model No. DK
250	■	–	7119.250
400	■	–	7119.400
250	–	■	7119.255
400	–	■	7119.455



#### Also required:

- Captive nuts, see page 477.
- Screws, see page 478.

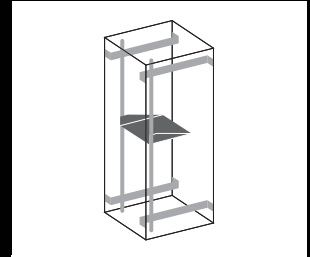

### Utility table

#### for location in the 482.6 mm (19") level for 482.6 mm (19") system punchings

The utility table may be attached directly between the 482.6 mm (19") mounting angles without any additional assembly work. The utility table has a height of 3 U and a support area of 450 x 295 mm; it can be used as a support for measuring devices or splicing equipment during maintenance and wiring work.

#### Material:

Sheet steel

#### Colour:

RAL 7035

#### Supply includes:

Assembly parts.

Support surface mm	Model No. DK
450 x 295	7183.100

#### Note:

Installation in enclosures with a TS trim frame is not possible.

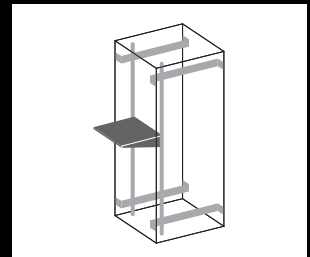

### Shelf

#### for AE with pull-out frame

The vented shelf is inserted into the pull-out frame of wall-mounted distributor DK 7644.000 and may additionally be screw-fastened. In this way, an additional support surface can be created with very little effort. Captive nuts may be clipped into the punchings of the frame, even after the shelf has been inserted.

#### Material:

Sheet steel

#### Colour:

RAL 7035

#### Supply includes:

Assembly parts.

Width mm	Depth mm	Model No. DK
430	195	7644.400

Extended delivery times.



# Interior installation

## Installation kits for component shelves



### TS punched section with mounting flange, 17 x 73 mm

#### as installation kit for component shelves

Simply locate and secure. One pack is sufficient for 2 component shelves.

#### Load capacity:

100 kg surface load, static

#### Material:

Sheet steel

#### Surface finish:

Zinc-plated

#### Supply includes:

Assembly parts.

Installation in enclosure depth mm	Packs of	Model No. TS
500	4	<b>8612.050</b>
600	4	<b>8612.060</b>
800	4	<b>8612.080</b>
1000	4	<b>8612.000</b>
1200	4	<b>8612.020</b>



### Installation kit, depth-variable

#### for 482.6 mm (19") component shelf

In conjunction with

- L-shaped mounting angles or
- Mounting frame 482.6 mm (19")

Infinitely adjustable to the spacing between the two pairs of 482.6 mm (19") mounting angles. Suitable for all 482.6 mm (19") component shelves in 409 mm width.

#### Material:

Sheet steel

#### Surface finish:

Zinc-plated

#### Supply includes:

1 set =  
2 mounting rails including assembly parts.

Length mm	Load capacity	U	Model No. DK
390 – 590	50 kg	1	<b>7063.858</b>
490 – 710	100 kg	1.5	<b>7063.892<sup>1)</sup></b>
590 – 790	50 kg	1	<b>7063.860</b>
706.5 – 1006.5	100 kg	1.5	<b>7063.890</b>

<sup>1)</sup> Max. depth of component shelves: 500 mm



#### Accessories:

Telescopic slides,  
see page 489.



### Adaptor for L-shaped mounting angles

#### for TS network enclosures

For mounting component shelves and slide rails on L-shaped mounting angles.

#### Material:

Sheet steel

#### Supply includes:

Assembly parts.

Packs of	Model No. DK
4	<b>7827.300</b>



### Installation kit

#### for component shelves and drawers, with 482.6 mm (19") installation in TS

For installation between the front and rear adaptor sections or adaptor pieces, 482.6 mm (19") in 600 mm wide enclosures.

#### Material:

Sheet steel, zinc-plated

#### Supply includes:

Assembly parts.

For enclosure depth mm	Packs of	Model No. TS
600	1 set	<b>8800.560</b>
800	1 set	<b>8800.580</b>

Max. depth of component shelves =  
Enclosure depth minus 100 mm.



#### Also required:

- Mounting angles, 482.6 mm (19"), see page 551.
- Adaptor pieces, 482.6 mm (19"), see page 552.





# Interior installation

## Accessories for component shelves

### Side parts 3 U

#### for static installation of component shelves, 482.6 mm (19")

For the attachment of component shelves to a single pair of 482.6 mm (19") mounting angles. The component shelves are screw-fastened to the 3 U side part.

Either one or two component shelves may be secured.

#### Load capacity:

30 kg surface load, static

#### Material:

Sheet steel

#### Colour:

RAL 7035

#### Supply includes:

2 side parts.

#### Note:

Not suitable for combination with telescopic slides.

Depth of side parts mm	For component shelf DK	Component shelf depth mm	Model No. DK
400	7143.035	300	7147.035
400	7144.035	400	
400	7145.035	500	

#### Note:

Component shelves, 482.6 mm (19"), see page 482.

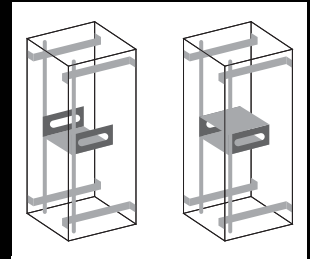
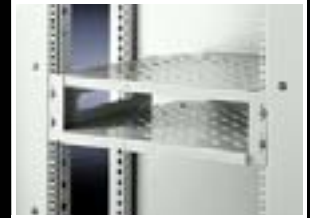

### Telescopic slides

#### for component shelves

Fixed component shelves are easily converted to full withdrawal. For this purpose, the existing fastening bolts or mounting rails (heavy-duty version) are exchanged for the telescopic slides.

#### Technical specifications:

For installation and locking on a 25 mm pitch pattern in the enclosure depth.

#### Load capacity:

50 kg/100 kg per set

#### Material:

Sheet steel, zinc-plated

#### Load capacity 50 kg

For component shelf depth mm	Packs of	Model No. DK
300	2	7051.000
400	2	7061.000
500	2	7081.000
600	2	7161.000
700	2	7161.700

#### Load capacity 100 kg

For component shelf depth mm	Packs of	Model No. DK
400	2	7064.000
500	2	7065.000
600	2	7066.000
700	2	7066.700

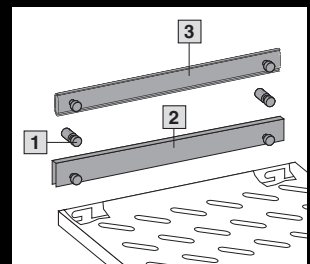

- 1 Fastening bolts
- 2 Mounting rails
- 3 Telescopic slides

# Interior installation

## Accessories for component shelves



### Cable support

#### hinged, with clamp

For secure routing of connection cables from the component shelf to the clamping point. The attachment may be released on both sides thanks to clamps.

**Material:**

Sheet steel, zinc-plated

**Supply includes:**

Assembly parts.

For enclosure depth mm	Model No. DK
< 600	7163.500
> 600	7163.550



### Cable support

#### hinged, with anti-kink device and clamp

For secure routing of connection cables from the component shelf to the clamping point. Kink-free cable routing in the central part via mobile chain links. The attachment may be released on both sides, thanks to clamps.

**Material:**

- Sheet steel, zinc-plated
- Centre part: Plastic

**Supply includes:**

Assembly parts.

For enclosure depth mm	Model No. DK
< 600	7163.560
> 600	7163.565



### Handles

#### for pull-out component shelves

The component shelves are prepared for the attachment of handles.

**Material:**

Die-cast zinc

**Surface finish:**

Spray-finished, silver-grey

**Supply includes:**

Assembly parts.

Packs of	Model No. RP
2	3636.010



### Fastening bolts

#### for slotted component shelves

For non-slip attachment of your components. The bolts are screwed into the slots of the component shelf support surface. Consequently, they are infinitely adjustable and can be adapted to suit any appliance.

Packs of	Model No. DK
4	7115.000



### System lights

- for direct attachment in all large enclosures
- for mounting on compact enclosures, wall-mounted enclosures and in the console system with system accessories.

#### Protection category:

IP 20 to IEC 60 529



#### Also required:

Connection accessories, see page 496.



#### Accessories:

- Adaptor bracket, see page 471.
- Universal bracket, see page 476.
- Rail for interior installation, see page 459.

Technical comparison/equipment		Standard light	Courtesy light	Universal light	Compact light	LED system light	
Page		492	492	492	493	494	
Voltage supply	100 – 240 V AC, 50/60 Hz	–	■	■	■	–	
	120 V AC, 60 Hz	■	–	–	–	–	
	230 V AC, 50 Hz	■	–	–	–	–	
	24 V DC	–	–	–	■	■	
Full-electronic ballast		–	■	■	■	–	
Light	Fluorescent lamp, base G13	■	■	–	–	–	
	Compact fluorescent lamp, base G24q-3	–	–	■	–	–	
	Fluorescent lamp T5	–	–	–	■	–	
	LEDs, cold white	–	–	–	–	■	
Protection category	II (all-insulated)	–	–	–	■	–	
	III (SELV)	–	–	–	–	■	
Installation type	Screw-fastening	■	■	■	■	■	
	Clip attachment	–	–	–	■	■	
	Magnetic attachment (accessory)	–	–	–	■	■	
Mounting options	TS roof frame (horizontal section) direct	■	■	■	■	■	
	TS vertical section	with adaptor bracket	■	■	■	–	–
		direct	–	–	–	■	■
	AE, CM, TP	with universal bracket	■	■	■	–	–
		with magnetic attachment	–	–	–	■	■
AE	with rail for interior installation	■	■	■	–	–	
Connection options	Infeed/connection cable	■	■	■	■ <sup>3)</sup>	■	
	Door-operated switch	■	■	–	■	■	
	Through-wiring (series connection of several lights)	■	■	■	–	■	
Approvals	UL/cUL	■ <sup>2)</sup>	–	■ <sup>2)</sup>	■ <sup>2)</sup>	– <sup>1)</sup>	
	ENEC	■ <sup>2)</sup>	■	–	■ <sup>2)</sup>	–	
	VDE	–	–	■ <sup>2)</sup>	–	–	
Equipment	Light cover	–	■	■	■	■	
	Light cone adjustment	–	–	■	–	■	
	Integral sockets, earthing-pin	■ <sup>2)</sup>	■	■	–	–	
	Integral sockets, USA	■ <sup>2)</sup>	–	–	–	–	
	Integral motion detector	–	–	■	–	–	
	Integral door-operated switch	■ <sup>2)</sup>	■ <sup>2)</sup>	–	–	–	

<sup>1)</sup> Safety extra-low voltage, not required by the standard.

<sup>2)</sup> Depending on the equipment.

<sup>3)</sup> Integral

# Interior installation

## System lights



### Standard light

Without door-operated switch

Technical specifications	Socket	Width mm	Height mm	Depth mm	Model No. SZ	Approvals
14 kW, 230 V, 50 Hz	Earthing-pin	452	117	50	<b>4138.140</b>	ENEC
18 kW, 230 V, 50 Hz	Earthing-pin	682	117	50	<b>4138.180</b>	ENEC
30 kW, 230 V, 50 Hz	Earthing-pin	987	117	50	<b>4138.300</b>	ENEC
14 kW, 120 V, 60 Hz	USA	452	117	50	<b>4138.240</b>	cURus
18 kW, 120 V, 60 Hz	USA	682	117	50	<b>4138.280</b>	cURus
30 kW, 120 V, 60 Hz	USA	987	117	50	<b>4138.400</b>	cURus

With door-operated switch

Technical specifications	Socket	Width mm	Height mm	Depth mm	Model No. SZ	Approvals
14 kW, 230 V, 50 Hz	Earthing-pin	452	117	50	<b>4138.150</b>	ENEC
18 kW, 230 V, 50 Hz	Earthing-pin	682	117	50	<b>4138.190</b>	ENEC
30 kW, 230 V, 50 Hz	Earthing-pin	987	117	50	<b>4138.350</b>	ENEC
14 kW, 120 V, 60 Hz	USA	452	117	50	<b>4138.250</b>	cURus
18 kW, 120 V, 60 Hz	USA	682	117	50	<b>4138.290</b>	cURus
30 kW, 120 V, 60 Hz	USA	987	117	50	<b>4138.450</b>	cURus



**Also required:**

Connection accessories,  
see page 496.



### Courtesy light

Without door-operated switch

Technical specifications	Socket	Width mm	Height mm	Depth mm	Model No. SZ	Approvals
14 W, 100 – 240 V, 50/60 Hz	Earthing-pin	452	117	50	<b>4139.140</b>	ENEC
18 W, 100 – 240 V, 50/60 Hz	Earthing-pin	682	117	50	<b>4139.180</b>	ENEC
30 W, 100 – 240 V, 50/60 Hz	Earthing-pin	987	117	50	<b>4139.300</b>	ENEC

With door-operated switch

Technical specifications	Socket	Width mm	Height mm	Depth mm	Model No. SZ	Approvals
14 W, 100 – 240 V, 50/60 Hz	Earthing-pin	452	117	50	<b>4139.150</b>	ENEC
18 W, 100 – 240 V, 50/60 Hz	Earthing-pin	682	117	50	<b>4139.190</b>	ENEC
30 W, 100 – 240 V, 50/60 Hz	Earthing-pin	987	117	50	<b>4139.350</b>	ENEC



**Also required:**

Connection accessories,  
see page 496.



### Universal light

With integral motion detector

Technical specifications	Socket	Width mm	Height mm	Depth mm	Model No. SZ	Approvals
26 W, 110 – 240 V, 50 – 60 Hz	Earthing-pin	345	95	55	<b>4155.100</b>	VDE
	–	345	95	55	<b>4155.000</b>	VDE
	–	345	95	55	<b>4155.500</b>	UL



**Also required:**

Connection accessories,  
see page 496.

# Interior installation

## System lights

### Compact light

#### Slimmer – Faster – Brighter

- Slimmer: Around 50% less height and depth and also around 75% less volume than conventional lights.
- Faster: Universal fast attachment via clips, screws, or powerful magnets (optional). Simply slide in at the side or rear, fit the light, and it's done!
- Brighter: Up to 75% greater luminous efficiency from the lamp with the same power helps to cut electricity costs.
- Door-operated switch can also be connected via a 2-pole connection.

#### Colour:

Similar to RAL 7035

#### Protection category:

IP 20 to IEC 60 529

#### Supply includes:

Compact light with clip and screw mounting kits, including assembly parts.



#### Accessories:

- Mounting kit magnet, see page 493.
- Door-operated switch with connection cable, see page 496.

Model No. SZ	ENEC 24	4140.010	–	4140.020	–	4140.110	4140.120
	cURus	–	4140.210 <sup>1)</sup>	–	4140.220 <sup>1)</sup>	–	–
Rated voltage	100 – 240 V AC ±10% at 50 – 60 Hz					24 V DC ±10%	
Wattage	8		14		8		14
Protection category	II (all-insulated)						
Width (B1) mm	455		705		455		705
Mounting distance (B2) mm	400		650		400		650
Clip/magnet	475		725		475		725
Connection cable	3 m (open end)						
Cover colour	Yellow	Grey	Yellow	Grey	Yellow	Yellow	
Rated current (A)	0.045 – 0.088		0.073 – 0.127		–		–
– at 230 V AC	0.083 – 0.149		0.149 – 0.216		–		–
– at 110 V AC	–		–		0.35		0.57
– at 24 V DC	–		–		–		–
Light	Fluorescent lamp T5						
Operating unit	Wide-range electronic ballast				Electronic ballast		
Circuit-breakers	Integral, on/off/door-operated switch mode						
Light cover	Transparent, grooved on the inside						
Cable deflector across rear	■	–	■	–	■	■	

<sup>1)</sup> Only for the North American market

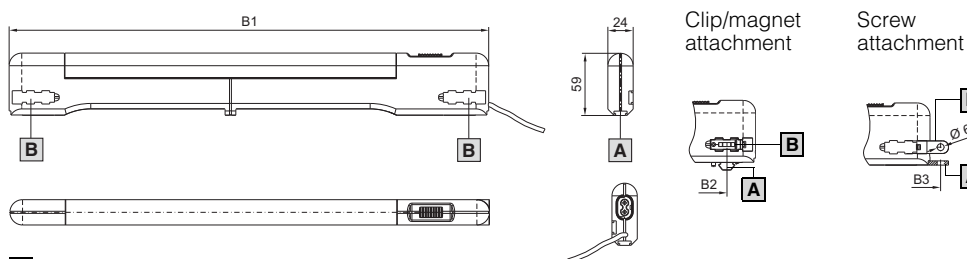

- A** Rear fastening
- B** Side attachment

### Mounting kit magnet

For reliable adhesion on all sheet steel surfaces.

Packs of	Model No. SZ
2	4140.000



# Interior installation

## System lights



### LED system light in 24 V DC version

- Max. EMC capacity
- Safe, thanks to use with safety extra-low voltage
- Economical energy use
- Low-maintenance thanks to the use of LEDs
- May be connected to a door-operated switch
- Integral through-wiring
- Universal attachment options
- Vertically hinged light cone

#### Material:

- Light body: Extruded aluminium
- Light cover: Polycarbonate (halogen-free)
- Light ends: PC-ABS

#### Colour:

Similar to RAL 7035

#### Protection category:

IP 20 to IEC 60 529

#### Supply includes:

System light with clip and screw mounting kits, assembly parts.

Model No. SZ	4140.810	4140.820	4140.830	4140.840
Rated voltage	<b>24 V DC (± 10%)</b>			
No. of LEDs	10	20	30	40
Protection category	<b>III (SELV)</b>			
Width (B1) mm	230	330	430	530
Mounting distance CLIP (B2) mm	175	275	375	475
Mounting distance, screw attachment (B3) mm	250	350	450	550
Rated current (A) <sup>1)</sup>	0,04	0,08	0,12	0,16
Circuit-breakers	Integral on/off/door-operated switch mode			

<sup>1)</sup>Maximum buying up to a total rated current strength of 2 amps.



#### Also required:

- LED connection cable, see page 495 or
- Door-operated switch with LED connection cable, see page 495.

#### Note:

Only intended for use in enclosures and sealed cases!  
When using on customer-supplied power packs, it is important to obtain the requisite approvals depending on the application!



#### Accessories:

- Mounting kit magnet, see page 493.
- Door-operated switch with LED connection cable, see page 495.
- LED connection cable, see page 495.
- Adaptor power pack, see page 495.

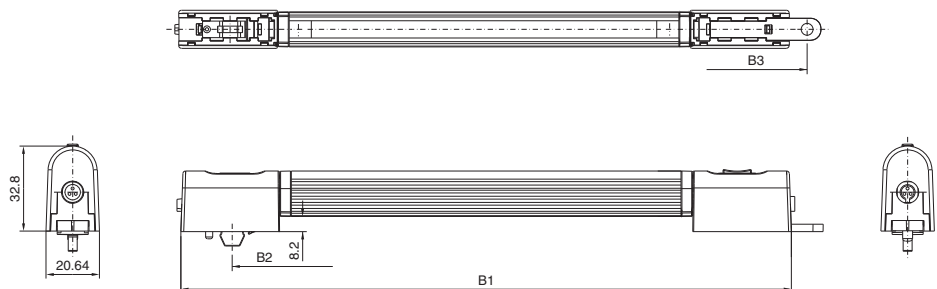

### Connection accessories

for LED system light

	Connection cable	Length mm	Packs of	Model No. SZ
<b>1</b>	LED connection cable	3000	1	<b>4315.800</b>
<b>Door-operated switch</b>				
		Length mm	Packs of	Model No. SZ
<b>2</b>	With LED connection cable	3000	1	<b>4315.810</b>
<b>3</b>	With LED interconnecting cable	1000	1	<b>4315.820</b>
<b>Interconnecting cable</b>				
		Length mm	Packs of	Model No. SZ
<b>4</b>	LED interconnecting cable	600	1	<b>4315.830</b>
		1000	1	<b>4315.840</b>
		3000	1	<b>4315.850</b>
<b>Adaptor power pack</b>				
		Technical specifications	Packs of	Model No. SZ
<b>5</b>	Adaptor power pack	230 V AC/24 V DC, 1 A	1	<b>4315.860</b>

### Layout diagram for LED system light 24 V DC:

- 1** Connection cable
- 2** Door-operated switch with LED connection cable (open end/cable bush)
- 3** Door-operated switch with LED connection cable
- 4** LED connection cable for through-wiring

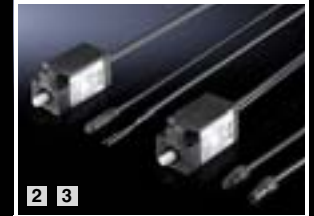
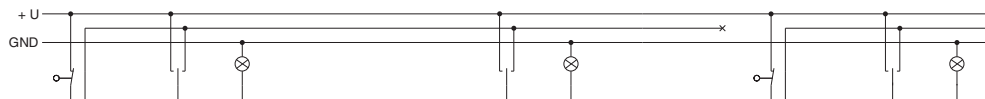
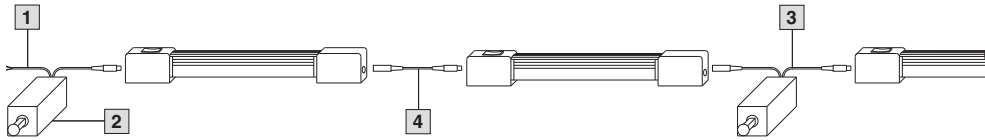

# Interior installation

## System lights



### Connection accessories

The following components can be used for time-saving and simple installation of the lights:



#### Accessories:

Cable ties for quick assembly, see page 530.

Connection cable for	UL	Length mm	Packs of	Model No. SZ	
				Orange	Grey
1 Power supply (with socket, without connector)		3000	5	4315.100	–
1 Power supply (with socket and strain relief, without connector)	■	3000	1	–	4315.150
2 Through-wiring (with socket and connector)	■	600	1	–	4315.450
2 Through-wiring/power supply via connection component SZ 2507.500 (with socket and connector)		600	5	4315.400	–
		1000		4315.200	–
		4000	1	4315.600	–

Door-operated switch With mounting accessories	UL	Length mm	Technical specifications	Packs of	Model No. SZ		
					Orange	Yellow	Grey
3 With connection cable (not required for universal lights and standard/courtesy lights with integral door-operated switch)		600	240 V AC, 6 A 125 V DC, 8 A 24 V AC, 6 A 24 V DC, 6 A	1	4315.520	–	–
		1000		1	4315.320	–	–
	■	600		1	–	–	4315.550
	■	1000		1	–	–	4315.350
Without connection cable	■	–		1	4127.010		
4 With connection cable (for compact light)		600		1	–	4315.710	–
	■	600		1	–	–	4315.720

#### Also required

Mounting kit for installation in TE	Model No. FR		
	7952.100		

Door-operated switch With toggle	UL	Technical specifications	Packs of	Model No. SZ
5 Without connection cable, for TS enclosures with installed large swing frame. The toggle is actuated via the tubular door frame of the sheet steel door, or in the case of glazed doors, via an adaptor included with the supply.	■	240 V AC, 6 A 125 V DC, 8 A 24 V AC, 6 A 24 V DC, 6 A	1	4127.210

Connection component with circuit-breaker 10 A	Packs of	Model No. SZ
6 Reduce assembly costs: Power is supplied rapidly and reliably to system and workstation lights via connection cables. For self-configured cables, connector SZ 2507.200 must be used. Connection component to be snapped onto the top hat rail.	1	2507.500

For self-assembly	Packs of	Model No. SZ
Sockets for power supply through-wiring	5	2507.100
7 Connectors for connection component through-wiring	5	2507.200
T distributor with 2 sockets, 1 connector	5	2507.300
Connector for door-operated switch cable	5	2507.400

- 1 Connection cable for infeed
- 2 Connection cable for through-wiring/infeed
- 3 Door-operated switch with connection cable

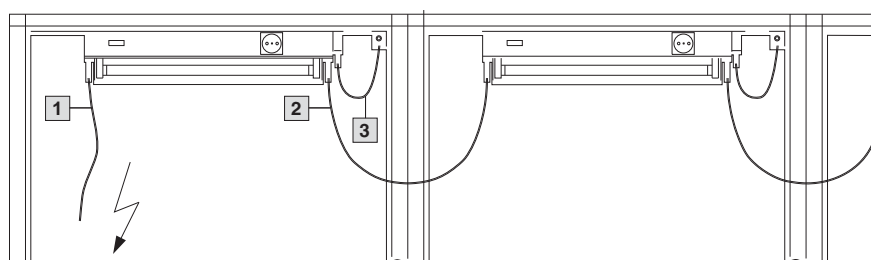



### Enclosure light, 48 V DC

#### With connection cable

Robust light. For attachment vertically or horizontally in the frame section via spring brackets, or may be used as a direct light source during maintenance work by inserting the plastic swivel hook. Impact-resistant lamp housing of PMMA (polymethylmethacrylate) protection category II.

#### Protection category:

IP 64

#### Supply includes:

- 2 spring clips
- Assembly parts

Packs of	Model No. CS
1	9765.150

#### Technical specifications:

- Luminosity: 11 W
- Luminous efficiency: 900 lm
- Fluorescent tube: TC-SEL 11 W, 4-pin
- Ambient temperature: -20°C to +40°C
- Voltage: 48 V DC ±10%
- Supply lead 3000 mm, H05RN – 2 x 1 mm, without connectors, with crimped ferrules
- Length:
  - 450 mm overall
  - Protective tube 320 mm
- Light outlet 195 mm
- Diameter:
  - 62 mm overall
  - Protective tube 38 mm



### Light 1 U

Complete ready-to-connect light for installation in the 482.6 mm (19") mounting angles. The slot attachment additionally allows it to be fastened to the 25 mm system punchings.

#### Technical specifications:

- Fluorescent tube 8 kW, 230 V, 50 Hz
- Mains switch
- 2.5 m connection cable
- Earthing-pin connector

#### Material:

- Aluminium, anodised
- Plastic

Packs of	Model No. DK
1	7109.200



# Interior installation

## EMC



### Rail

**for EMC shielding bracket and strain relief**  
Combined rail for strain relief and EMC contact-  
ing of inserted cables.

Mounting options:

- On the horizontal/vertical TS, PC, ES enclosure section
  - On a mounting plate
- May also be fitted without a retaining bracket.  
Additional contacting on the left or right of the rail  
via existing holes (9 mm diameter).

**Material:**

Sheet steel

**Surface finish:**

Zinc-plated

**Supply includes:**

- 1 rail
- 2 retaining brackets
- Assembly parts

Width mm	Packs of	Model No. SZ
600	1	<b>2388.600</b>
800	1	<b>2388.800</b>
1000	1	<b>2388.000</b>
1200	1	<b>2388.120</b>



#### Also required:

- EMC shielding bracket, see page 498.
- Cable clamps for strain relief, see page 529.



#### Accessories:

- Earth straps, see page 501.
- Earthing strap, see page 501.

Rail

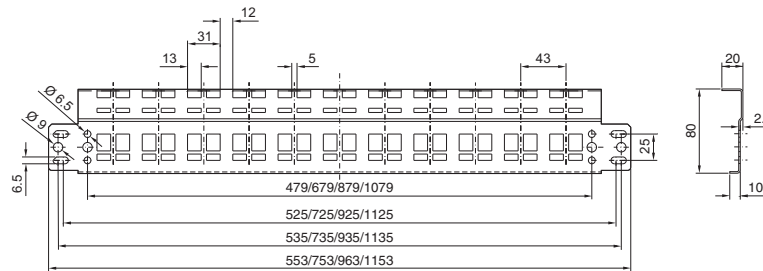

Retaining bracket

Mounting position

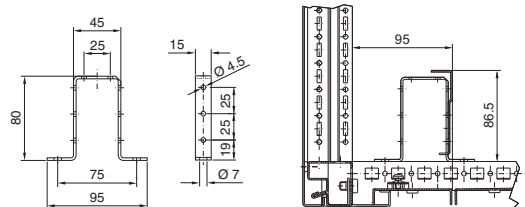

### EMC shielding bracket

Quick assembly without the use of tools:  
Press the EMC shielding bracket against the  
cable shield and clip into the rail.  
Diameter changes are compensated in full by  
the spring of the EMC shielding bracket.

**Material:**

Sheet steel

**Surface finish:**

Zinc-plated

For shield diameter mm	Packs of	Model No. SZ
3 - 10	10	<b>2388.100</b>
4 - 15	10	<b>2388.150</b>
10 - 20	10	<b>2388.200</b>
15 - 28	10	<b>2388.280</b>

### EMC gland plates

For shielded cables with a maximum diameter of 20 mm.

Combined EMC/IP seal provides low-resistance contact between cable shield and gland plate. For all 400, 500, 600 and 800 mm deep enclosures in conjunction with standard gland plates.

**Material:**

Sheet steel

**Surface finish:**

Zinc-plated

**Supply includes:**

- 1 gland plate with T-head punching
- 1 sliding gland plate
- 2 IP/EMC gaskets

Width mm	Packs of	Model No. TS
600	1 set	<b>8800.660</b>
800	1 set	<b>8800.680</b>
1000	1 set	<b>8800.600<sup>1)</sup></b>
1200	1 set	<b>8800.620<sup>1)</sup></b>

<sup>1)</sup> For one enclosure half only



### EMC cable glands

The cable sheathing may optionally be interrupted at the contact point or removed completely inside the enclosure.

The cable shield in the enclosure is retained. The supplied lock nut cuts automatically into the paint when screwed down, thus creating a conductive connection.

**Protection category:**

IP 68 to IEC 60 529

IP 69K to DIN 40 050-9

**↔ Possible alternative:**

Cable gland Hygienic Design, see page 521.

#### Cable glands, metric

Size	Cable diameter mm	Minimum <sup>1)</sup> shield diameter mm	Packs of	Model No. SZ
M16	4.5 – 10	3	5	<b>2843.160</b>
M20	6 – 12	5	5	<b>2843.200</b>
M25	11 – 17	8	5	<b>2843.250</b>
M32	15 – 21	10	1	<b>2843.320</b>
M40	19 – 28	15	1	<b>2843.400</b>
M50	27 – 38	19	1	<b>2843.500</b>
M63	34 – 44	30	1	<b>2843.630</b>

<sup>1)</sup> Minimum shield diameter = cable diameter minus cable sheathing



#### Cable glands, PG

PG size	Cable diameter mm	Minimum <sup>1)</sup> shield diameter mm	Packs of	Model No. SZ
9	4 – 8	3	5	<b>2411.090</b>
11	5 – 10	4	5	<b>2411.110</b>
13.5	6 – 12	5	5	<b>2411.140</b>
16	10 – 14	8	5	<b>2411.160</b>
21	13 – 18	10	1	<b>2411.210</b>
29	18 – 25	15	1	<b>2411.290</b>

<sup>1)</sup> Minimum shield diameter = cable diameter minus cable sheathing

### EMC shield bus

Made of clear chromated steel strip, 75 mm<sup>2</sup> cross section, for cable shield contact.

**Supply includes:**

Assembly parts.

Rail length mm	Connections	Packs of	Model No. SZ
375	10	1	<b>2413.375</b>
550	16	1	<b>2413.550</b>



# Interior installation

## EMC



### EMC earth clamps

The clamps may be used directly on the device or operating equipment on the mounting plate for cable shield contact.

**Material:**  
Sheet steel

**Surface finish:**  
Zinc-plated

Size mm	Packs of	Model No. SZ
4	50	2367.040
6	50	2367.060
8	50	2367.080
12	50	2367.120
16	50	2367.160
20	25	2367.200 <sup>1)</sup>

<sup>1)</sup> 2 assembly brackets



### EMC baying seal for TS

For baying enclosure systems. Seal with all-round, electrically conductive sheathing.

**Supply includes:**  
3 seals, length 2 m each.

Cross section mm	Model No. TS
6.3 x 6.3	8800.690



### EMC divider panel seal

This seal ensures optimum contact in bayed EMC enclosure systems and when using a zinc-plated divider panel.

**Material:**  
PU foam with electrically conductive sheathing.

**Supply includes:**  
1 roll (12.7 x 12.7 x 5300 mm).

Packs of	Model No. SZ
1	4348.000



### Contact cutter

The contact cutter enables EMC-compatible preparation of the contact point e.g. for earthing straps.

Plastic-bound abrasive with guide pin for round system punchings.

With location point for drill, grinder etc.

For	Model No. SM
Frame section	2414.000
Earthing bolts <sup>1)</sup>	2414.500

<sup>1)</sup> Not necessary with TS

### Contact paint

Contact paint prevents the corrosion of conductive, unprotected contact points.

**Contents:**  
12 ml

Packs of	Model No. SZ
1	2415.000

### Earth straps

For configuring a reliable earthing connection with perfect contact.

- With ring terminals in M6 and M8 to match the earthing screw
- Length-optimised and ready to install

Enclosure	Connection facility		
	Door/lid	Enclosure	Mounting plate
KL	M6	M6	M8
EB/BG	M6	M6/M8 <sup>1)</sup>	–
AE	M6	M6 <sup>2)</sup> /M8	M8
KE/KEL	M8	M8	M8
AP/CM/TP	M6	M8	M8
TS/ES	M8	M8	M8
PC	M8	M8	–

<sup>1)</sup> M8 with BG 1050.900

<sup>2)</sup> M6 with AE 1032.XXX/AE 1035.XXX

Connection	Cross-section mm <sup>2</sup>	Length mm	Packs of	Model No. SZ
M8 – M8	4	170	5	<b>2564.000</b>
M8 – M8	16	170	5	<b>2565.000</b>
M8 – M8	25	170	5	<b>2566.000</b>
M6 – M6	10	200	5	<b>2565.100</b>
M8 – M8	4	300	5	<b>2567.000</b>
M6 – M8	10	300	5	<b>2565.110</b>
M8 – M8	10	300	5	<b>2565.120</b>
M8 – M8	16	300	5	<b>2568.000</b>
M8 – M8	25	300	5	<b>2569.000</b>



### Earthing strap

Tin-plated copper, in various lengths and cross-sections with press-fitted contact rings. Earthing straps counteract the current displacement effect at high frequencies, whilst at the same time offering highly flexible connection opportunities.

For	Cross-section mm <sup>2</sup>	Length mm	Packs of	Model No. SZ
M6	10	200	10	<b>2412.210</b>
M8	16	200	10	<b>2412.216</b>
M8	25	200	10	<b>2412.225</b>
M6	10	300	10	<b>2412.310</b>
M8	16	300	10	<b>2412.316</b>
M8	25	300	10	<b>2412.325</b>



### Assembly parts

#### for system punchings

For fastening the earth straps and earthing braids to:

- Horizontal TS enclosure sections
- PS rail system
- ES system punchings.

Size	Packs of	Model No. SZ
M6	10 set	<b>2570.000</b>
M8	10 set	<b>2559.000</b>



#### Also required:

For mounting on the horizontal TS enclosure section: Captive nut, see page 477.



### Assembly parts

#### for gland plates

For fastening the earth straps and earthing braids to:

- Gland plates

Fast assembly thanks to self-tapping screws.

Size	Packs of	Model No. SZ
M8	10 set	<b>2570.200</b>



### Contact washers

Serrated contact washers facilitate secure PE conductor connection. As a result, there is no need to manually strip paint in the connection area.

Size	Packs of	Model No. SZ
M5	100	<b>2343.000</b>
M6	100	<b>2334.000</b>
M8	100	<b>2335.000</b>



# Interior installation

## Earthing



### Earthing plate

For installation in:

- Comfort Panel
- Optipanel
- TS
- ES

One earthing cable can be screw-fastened to the threaded bolt and can be distributed to up to 8 components via 6.3 mm flat-pin connectors.

Packs of	Model No. SZ
1	2570.500

**Supply includes:**  
Assembly parts.



### Central earthing point

For connecting

- Earth straps
- Earthing braids

to the vertical and horizontal enclosure profile. The connection bracket is connected to the enclosure frame with 2 screws and is securely contacted.

Earth connection is carried out via the threaded bolt M8 x 20 mm.

**Material:**

Sheet steel, zinc-plated

Packs of	Model No. DK
1	7829.200

**Supply includes:**

- 1 connection bracket
- 2 screws 5.5 x 13 mm
- 2 serrated washers
- 1 nut M8
- 1 contact washer M8
- 1 washer



### Potential equalisation star

**for 8 mm earthing bolt**

The earthing connector is used for simple potential equalisation on an 8 mm earthing bolt, or in conjunction with central earthing point DK 7829.200. Up to five flat connectors (6.3 mm) may be contacted on one earthing point.

Packs of	Model No. DK
10	7548.210

**Supply includes:**

- 10 earthing connectors
- Assembly parts



### Complete earthing kit

**for TS**

To DIN EN 60 950/VDE 0805, Ø 4 mm<sup>2</sup>, I<sub>max</sub> 40 A.

For system-compatible earthing of all enclosure parts on the enclosure frame according to VDE.

The earth conductors are pre-assembled ready for connection with connectors and cut to the right length.

Packs of	Model No. DK
1 set	7829.150

**Supply includes:**

- 8 earth straps
- Central earthing point and assembly parts

### Extension kit for complete earthing kit

**for TS**

To DIN EN 60 950/VDE 0805, Ø 4 mm<sup>2</sup>, I<sub>max</sub> 40 A.

To extend the complete earthing kit DK 7829.150, in order to keep additional components potential-free.

Conductor length 300 mm in each case.

For 6.3 mm flat-pin connectors, 8 mm earthing bolts or for attachment with contact washers and screw.

Packs of	Model No. DK
1 set	7829.152

**Supply includes:**

- 5 earth straps
- Assembly parts and identification labels

# Interior installation

## Earthing

### Complete earthing kit

#### for TE

To DIN EN 60 950/VDE 0805, Ø 4 mm<sup>2</sup>, I<sub>max.</sub> 40 A.  
For system-compatible earthing of all enclosure parts on the enclosure frame according to VDE.  
The earth conductors are pre-assembled ready for connection with connectors and cut to the right length.

Packs of	Model No. TE
1 set	7000.675

#### Supply includes:

- Earthing strip
- 4 earth straps, 300 mm
- 4 earth straps, 550 mm
- Assembly parts

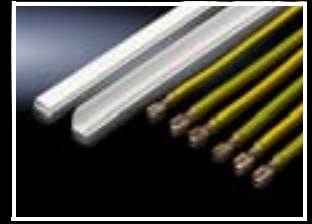

### Earthing kit KE

For producing the required external potential equalisation for painted series enclosures

- KL
- AE
- TS

For applications in Unit Group II, Category 3, in compliance with Directive 94/9 EU-Appendix VIII, internal production control.

Packs of	Model No. KE
5	9214.000



### Earthing kit

#### for KL

Consisting of all the screws, nuts, contact washers and earthing strip needed to earth the cover; length 250 mm, cross-section 4 mm<sup>2</sup>.

Packs of	Model No. KL
5	2570.100



### Earthing kit

#### for QuickBox

Earth straps in the appropriate lengths to match the enclosure depth are included in the earthing set, for earthing all enclosure panels on the wall mounting part. The earth strap is a fast-on connector which is quickly disconnected and conveniently accessible when the door is open. In this way, the enclosure cover can be removed completely.

For enclosure depth mm	Packs of	Model No. QB
300/400	1 set	7502.240
500/600	1 set	7502.260

#### Supply includes:

- 5 earthing leads 1.5 mm<sup>2</sup>
- 4 cable retention clips
- Assembly parts

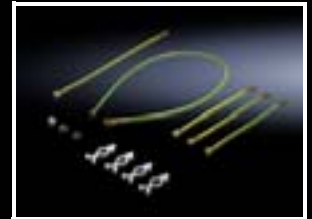

### PE busbar

699 mm long PE busbar with pre-fitted screws, including terminal clamps up to 6 mm<sup>2</sup> (fine wire conductors), 10 mm<sup>2</sup> (single wire or multi-wire conductors) and main terminal clamp up to 35 mm<sup>2</sup>.

Packs of	Model No. SZ
1	2364.000



#### Accessories:

Rail mounting bracket, see page 476.



# Interior installation

## Earthing



### Earth rail, horizontal

for TS

#### Potential equalisation rail

Current carrying capacity approx. 200 A.

#### Supply includes:

- Earth rail made from E-Cu 57 to DIN 12 163, DIN EN 13 601, 15 x 5 mm
- 20 connection points with M5 screws
- 2 earth connections 25 mm<sup>2</sup>
- 2 isolators, including assembly parts

Length mm	Packs of	Model No. DK
450	1	7113.000

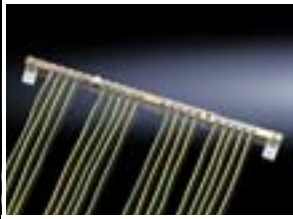

### Earthing kit, pre-assembled

for TS

For star earthing. With the pre-assembled earth conductors on a potential equalisation rail, star potential equalisation is easily integrated into network enclosures.

#### Supply includes:

- Earth rail made from E-Cu 57 to DIN EN 12 163, DIN EN 13 601
- 16 earthing leads 6 mm<sup>2</sup>
- 2 isolators
- Assembly parts

For TS enclosures up to W x H x D mm	Packs of	Model No. DK
800 x 2000 x 800	1 set	7829.100
800 x 2200 x 1000	1 set	7829.110



### Earth rail, vertical

for TS

Easily fitted to the 25 mm DIN pitch pattern of distributors or to the 482.6 mm (19") mounting angles. The supplied earth conductors facilitate star earthing of the cable clamp straps in the patch panels.

The earth terminals are fully adjustable.

Current carrying capacity of rail approx. 200 A.

#### Supply includes:

- Earth rail made from E-Cu 57 to DIN 12 163, DIN EN 13 601, 15 x 5 mm
- 16 conductor connection clamps 2.5 – 16 mm<sup>2</sup>
- 15 earthing leads 6 mm<sup>2</sup>, L = 500 mm
- Assembly parts

For enclosure height mm	Length mm	Packs of	Model No. DK
800	600	1 set	7541.000
1000	800	1 set	7542.000
1200	1000	1 set	7543.000
1400	1200	1 set	7544.000
1600	1400	1 set	7545.000
1800	1600	1 set	7546.000
2000	1800	1 set	7547.000
2200	2000	1 set	7548.000

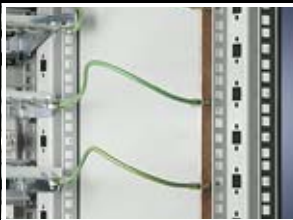

### Extension kit

for earth rail, vertical

For system-compatible expansion of the star earthing on the vertical potential equalisation rail.

#### Supply includes:

- 15 earthing leads 6 mm<sup>2</sup>, L = 500 mm,
- Preassembled, with ring terminal and wire end ferrule
- Earth terminals, 2.5 – 16 mm<sup>2</sup>
- Assembly parts

Packs of	Model No. DK
10	7549.000



### ESD connection point

Dangerously high potential differences can occur during maintenance or conversion work on the enclosure. To protect sensitive electronic components, this standardised connection point (push-button) provides potential equalisation. The connection point is directly conductively connected to the enclosure frame via two screws.

Packs of	Model No. DK
1	7752.950

#### Material:

Sheet steel, zinc-plated

#### Supply includes:

Assembly parts.



### Socket strips

The socket strips in the aluminium channel are available in various lengths with different functional elements. Special attention has been devoted to practical, universal fastening: With a bracket which may be used in four positions, there is a range of attachment options. Hence, for example, the 482 mm long socket strip may optionally be mounted on 482.6 mm (19") mounting angles, the 482.6 mm (19") mounting frame, on the enclosure frame, or in the rear section of the wall-mounted distributor. Without additional mounting accessories, the socket strip may be inserted into all sections with a 25 mm pitch pattern. This makes selection much easier, as well as providing additional flexibility and saving on warehousing. Provision has also been made for cable routing of the infeed, and when mounting in the 482.6 mm (19") section there is adequate space to route the infeed between the socket strip and the mounting angle without kinks. The arrangement of the sockets at a 45° angle allows unrestricted use of angular connectors.

#### Technical specifications:

- Rated voltage: 250 V
- Rated current: 10/16 A
- Connection cable: 2 m long H05VV-F3G1.5

#### Material:

- Aluminium section: Natural-anodised
- Socket inserts: Polycarbonate

#### Supply includes:

- Socket strip
- Two mounting brackets
- Assembly parts

#### Standards:

- Sockets:
  - DIN VDE 0620-1
- Sockets B/F:
  - UTE NFC 61-303, CEE 7/NV
- Overvoltage protection for low voltage:
  - DIN EN 61 643-11 (VDE 0675 Part 6-11)
- EMC interference suppression filter:
  - DIN EN 60 939-2 (VDE 0565 Part 3),
  - DIN VDE 0620-1 (VDE 06204-1)

#### Detailed drawings and further information:

Available on the Internet.

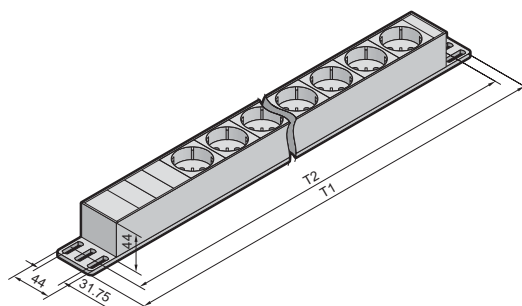
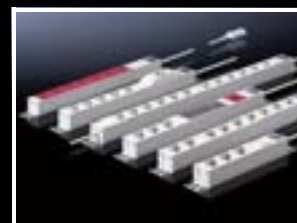

Design	Connection	Number of sockets	Connector type	Attachment			Length (T1) mm	Mounting dimension (T2) mm <sup>1)</sup>	Model No. DK
				Frame	Wall-mounted distributor, horizontal	482.6 mm (19") level			
Without rocker switch	Cable	3	Earthing-pin	■	–	–	262.6	232.5	<b>7240.110</b>
		7	Earthing-pin	■	■	■	482.6	452.5	<b>7240.210</b>
		12	Earthing-pin	■	–	–	658.6	628.5	<b>7240.310</b>
With rocker switch	Cable	3	Earthing-pin	■	■	–	306.6	276.5	<b>7240.120</b>
		7	Earthing-pin	■	■	■	482.6	452.5	<b>7240.220</b>
Overvoltage protection and interference suppression filter	Cable	5	Earthing-pin	■	■	■	482.6	452.5	<b>7240.230</b>
		9	Earthing-pin	■	–	–	658.6	628.5	<b>7240.330</b>
Miniature circuit-breaker	Cable	5	Earthing-pin	■	■	■	482.6	452.5	<b>7240.240</b>
Master-slave	Cable	1 + 3	Earthing-pin	■	■	■	482.6	452.5	<b>7240.250</b>
UPS strip	C14	7	Earthing-pin	■	■	■	482.6	452.5	<b>7240.260</b>
RCCB	Cable	5	Earthing-pin	■	■	■	482.6	452.5	<b>7240.280</b>
RCCB and line protection	Cable	5	Earthing-pin	■	■	■	482.6	452.5	<b>7240.290</b>
For IEC 320 connectors, 10 A	Cable	12	C13	■	■	■	482.6	452.5	<b>7240.200</b>
For IEC 320 connectors with IEC 320 input, 10 A	C14	9	C13	■	■	■	482.6	452.5	<b>7240.201</b>
For IEC 320 connectors with overvoltage protection and interference suppressor filter, 10 A	Cable	6	C13	■	■	■	482.6	452.5	<b>7240.205</b>
With 2 circuits	Cable	6 + 6	Earthing-pin	■	–	–	720.6	690.5	<b>7240.370</b>
B/F sockets (Belgium, France)	Cable	7	Earthing-pin	■	■	■	482.6	452.5	<b>7240.510</b>
B/F sockets (Belgium, France)	Cable	12	Earthing-pin	■	–	–	658.6	628.5	<b>7240.512</b>

<sup>1)</sup> Variable attachment distance within a range of 5 mm, the distance given is hole centre – hole centre of mounting bracket.

# Voltage supply

## Socket strips



### Socket strips

#### With C13/19 sockets

Socket strips with 2 m connection cable  
H05VV-F3G6 1.5 (PVC) with wire end ferrules.

#### Detailed drawing:

Available on the Internet.

Design	Number of sockets	Attachment			Length mm	Mounting dimension mm <sup>1)</sup>	Model No. DK
		Frame	Wall-mounted distributor, horizontal	482.6 mm (19") level			
C13 IEC 320 socket <sup>3)</sup>	15	■	–	–	592.6	562.5	<b>7240.130</b>
C13 IEC 320 socket <sup>3)</sup> with 2 <sup>2)</sup> infeeds	9 + 9	■	–	–	764.6	734.5	<b>7240.150</b>
C19 IEC 320 socket <sup>4)</sup>	6	■	■	■	482.6	452.5	<b>7240.160</b>
C19 IEC 320 socket <sup>4)</sup> with overvoltage protection device	4	■	■	■	482.6	452.5	<b>7240.170</b>
C19 IEC 320 socket <sup>4)</sup> with 2 <sup>2)</sup> infeeds	3 + 3	■	■	■	478.6	448.5	<b>7240.190</b>

All socket strips may also be ordered with a Wieland GST infeed.

<sup>1)</sup> Variable attachment distance within a range of 5 mm, the distance given is hole centre – hole centre of mounting bracket.

<sup>2)</sup> In order to make allowance for the higher output density e.g. in an IT environment, the socket strips are equipped with 2 independent infeeds. This means it is possible to supply 2 x 16 A/250 V with one socket strip.

<sup>3)</sup> With IEC 320 socket to standard F EN 60 320-2-2

<sup>4)</sup> With IEC 320 socket to standard J EN 60 320-2-2

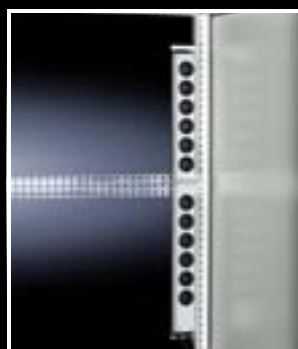

### Socket strips 230 V

#### Technical specifications:

- Rated voltage 250 V AC
- Max. load  
CH 10 A,  
GB 13 A.

#### Material:

- Plastic, halogen-free
- Connection cable, 2 m long, without connector H05VV-F3G1 (CH)  
H05VV-F3G1,5 (GB)
- Unrestricted use, including angular connectors, thanks to the long row arrangement of plug-type contacts.

Number of sockets	Length mm	Design	Model No. DK
6	470 <sup>1)</sup>	GB	<b>7404.000</b>
12	793		<b>7408.510</b>
18	1153		<b>7412.510<sup>2)</sup></b>
6	470 <sup>1)</sup>	CH	<b>7604.000<sup>2)</sup></b>
12	793		<b>7608.510<sup>2)</sup></b>

<sup>1)</sup> The socket strips can be mounted horizontally at the rear of the DK wall-mounted distributor based on EL/AE.

<sup>2)</sup> Extended delivery times.



### Socket strip TE

8-way socket strip for earthing-pin plug/version D. The strip is made of plastic and may be mounted vertically on the TE frame or in the rear 482.6 mm (19") section. In the 482.6 mm (19") section, more than 2 U of space is required. The sockets are arranged at an angle of 45° so that angular connectors are also easily used. The socket strip is supplied with a 2 m connection cable. The connection cable is contacted in a terminal slot in the strip.

The terminal slot has a separate cover. The socket strip has external terminals for separate earthing.

Socket strip TE	Model No. DK
8-way, earthing-pin	<b>7000.630</b>

#### Technical specifications:

- Rated voltage: 230 Volt AC
- Rated current: Max. 16 A
- Connection cable: Length 2 m, H05VV-F3G1, 1.5 mm<sup>2</sup>, without connectors, with wire end ferrules

# Voltage supply

## Socket strips

### Socket strip, 482.6 mm (19"), with fuse

#### with optional locking of the cable outlets

The socket strip constructed from an aluminium channel, is 482.6 mm (19") wide and 1 U high, and may be integrated into all standard 482.6 mm (19") mounting frames.

Special attention has been devoted to practical, universal fastening. The universal mounting bracket creates variable mounting opportunities. For example, the 439 mm long socket strip may optionally be mounted on the 482.6 mm (19") mounting angle or on the punched section with mounting flange and enclosure frame.

Additionally, a locking option for the outgoing cables to the equipment has now been integrated. This protects the cables from unintentional loosening, which in turn increases the security and availability of applications.

Design	Model No. DK
12 x C13	7240.600

#### Technical specifications:

- 10 A fuse/slow
- Cable type: H05VV
- Mains voltage: 250 V
- Rated current: 10/10 A
- Connection cable: 1.5 m

#### Supply includes:

- Socket strip
- Two mounting brackets
- Assembly parts



#### Accessories:

PSM cable lock, see page 204.



### Socket strips

#### with ammeter

The socket strip with ammeter measures the active power of the connected equipment. The two variants "earthing pin contact" and "IEC 320 socket C13" provide the most commonly used plug-in contacts in data centres. The 482.6 mm (19") long socket strip may optionally be mounted on the 482.6 mm (19") mounting angles, on the 482.6 mm (19") mounting frame, on the enclosure frame or in the rear section of wall-mounted distributors. The installation bracket may be mounted in four different positions for variable mounting. Without additional mounting accessories, the socket strip may be inserted into all sections with a 25 mm pitch pattern.

#### Material:

- Aluminium section: Natural-anodised
- Socket inserts: Polycarbonate

#### Supply includes:

- Socket strip
- Two installation brackets
- Assembly parts
- 1.5 m connection cable with open ends

#### Technical specifications:

- Mains voltage: 250 V
- Rated current: 16 A
- Connection cable: 1.5 m



Design	Number of sockets	Attachment			Length mm	Mounting dimension mm <sup>1)</sup>	Model No. DK
		Frame	Wall-mounted distributor, horizontal	482.6 mm (19") level			
Earthing-pin	6	■	■	■	482.6	464.1	7240.300
C13 IEC 320 socket	8	■	■	■	482.6	464.1	7240.305

<sup>1)</sup> Variable attachment distance within a range of 5 mm, the distance given is hole centre – hole centre of mounting bracket.

# Voltage supply

## Socket strips



### Socket strip CMC-TC

With integral

- interference suppressor filter
- Overvoltage protection
- Alarm contact

In the event of interference caused by overvoltage, the connected active network components are protected. With the relay message contact, undervoltage and any malfunctions caused by overvoltage can be reported via the CMC-TC in the network (SNMP trap). A green light on the strip indicates that the device is operational. The second protective device is the interference suppressor filter which protects valuable equipment as a passive component.

#### Technical specifications:

- Number of sockets: 9
- Length of strip: 650 mm
- Rated voltage: 230 V AC, 50/60 Hz
- Rated current: 16 A
- Relay alarm output: RJ 10 jack
- Relay load capacity: 50 Volt DC 100 mA

Packs of	Model No. DK
1	7200.630

#### Technical specifications, overvoltage protection:

- Arrester application category: D
- Surge current resistance per conductor: 2.5 kA
- Maximum surge current resistance: 8 kA



#### Also required:

For connecting the socket strip, the CMC III or CMC III Compact and an RJ 10 connection cable are required.



### Junction box

#### with multi-functional bracket

The angle bracket can be installed in all network enclosures in a system-compatible design. The junction box serves as a transfer point for the power supply to all equipment (fans, lamps and socket strips). As well as being used as a junction box or interchange point, the bracket may also accommodate the enclosure internal thermostat (SK 3110.000) or the hygrostat (SK 3118.000) thanks to its integral holes.

Packs of	Model No. DK
1 set	7280.035

#### Material of bracket:

Sheet steel

#### Colour of bracket:

RAL 7035

#### Supply includes:

- 1 bracket
- 1 junction box
- 6 m connection cable 3 x 1.5 mm<sup>2</sup> (flexible)



### Socket

- For mounting on support rails TS 35/7.5 and TS 35/15 to EN 60 715
- Screw terminals uniformly from one side
- Enclosure width 45 mm

#### Technical specifications:

- Rated voltage: 250 V AC
- Rated current (AC): 16 A

#### Material:

Polyamide

#### Colour:

Grey

#### Standards:

- DIN VDE 0620-1
- DIN 49 440-1

Design	Packs of	Model No. SZ
Germany	2	2506.100

# Voltage supply

## Socket strips

### Service socket

#### For enclosure frame attachment/16 A

Integration of a service socket within a separate supply circuit, independently of the IT network and UPS.

Simple installation via an angle bracket for attaching to the enclosure frame.

#### Material:

- Angle bracket: Sheet steel
- Socket: Plastic

#### Surface finish:

Angle bracket: Zinc-plated

#### Supply includes:

- Angle bracket
- Damp-proof socket (IP 44)
- Assembly parts

Packs of	Model No. DK
1 set	7280.100



### Energy-Box, 482.6 mm (19")

#### Technical specifications:

A depth-variable top hat rail for installed equipment to DIN 43 880, sizes 1 – 3 (e.g. to accommodate built-in sockets, miniature circuit-breakers etc.). Cable clamping at the rear, one N and one PE rail on an insulated plinth. Plastic cover including extension cover (UL 94-V0), maximum accommodation of 22 installed devices (width 18 mm). Maximum accommodation capacity = 22 HP (22 x 18 mm = 396 mm).

Packs of	U	Model No. DK
1	3	7480.035

#### Colour:

RAL 7035

#### Supply includes:

Energy-Box with plastic blanking covers.

#### Note:

Individual population with circuit-breakers at the factory available on request.



### Energy-Box, 482.6 mm (19")

#### Pull-out

This Energy-Box is designed to accommodate both DC and AC components. The pull-out component front affords optimum access to the wiring space from above and below.

Connection clamps for DC current:

2 clamps 35 mm<sup>2</sup>,  
9 clamps 16 mm<sup>2</sup> (per rail)

for AC current:

1 clamp 16 mm<sup>2</sup> (PE or N),  
20 clamps 4 mm<sup>2</sup> (per rail)

#### Technical specifications:

Depth-adjustable top hat rail for snap-in attachment of installed equipment to DIN 43 880 in sizes 1 – 3 (e.g. to accommodate built-in sockets, miniature circuit-breakers etc. or entire installation assemblies such as the ABB "smisline" system). Cable clamping at the rear, two power distribution rails with connection clamps on isolated base/plinth. Plastic cover including extension cover, maximum accommodation of 22 items of installed equipment (width 18 mm).

Maximum accommodation capacity = 22 HP (22 x 18 mm = 396 mm).

Depth: 220 mm.

U	Model No. DK
3	7480.300

#### Colour:

RAL 7035

#### Supply includes:

Energy-Box with plastic blanking covers.



# Voltage supply

## Socket strips



### Rittal Power Control Unit (PCU)

#### Socket strip, IP-compatible, 1 U

Featuring 8 current outlets with IEC 320 C13 slots. Each of the 8 slots is individually switchable (via the CMC III system). Furthermore, a current indicator, circuit display and thermal overload protection are integrated into the module. Installation on the enclosure frame or in the 482.6 mm (19") section (1 U) of a rack.

#### Operate the socket strip without CMC:

For operation of the socket strip, power pack DK 7201.210 and a connection cable are required. Up to 4 socket strips may be operated with one power pack.

Available functions: Current display, circuit display, automatic selective activation.

#### Operate the socket strip with CMC:

No additional power pack is required: The PCU is supplied via the CMC III system. You will need the CMC III or CMC III Compact, plus a CMC III CAN bus unit. See page 581 for details.

Available functions: Current display, automatic selective activation via CMC III in the network; Individual switching of the 8 current outlets, current limit monitoring, delayed switching of the individual current outlets, status display of the module.

#### Description of functions:

- 2-digit local LED 7-segment current display on the PCU. Legibility rotates according to the installation position.
- Measuring and monitoring of the current per PCU. Min./max. limits may be set. Measurement range 0 – 16 A.
- Alarm notifications via a flashing display.
- Monitoring of the thermo-fuse.
- PCUs may be combined via the bus system, thereby enabling selective activation.
- In conjunction with the CMC III, the 8 individual current outlets of the PCUs may be activated and deactivated individually via HTTP and SNMP.
- Remote administration of the power supply, editing and monitoring of remote limits, SNMP trap messages in case of alarm.
- 8 IEC 320 C13 slots per PCU.
- User administration.

#### Dimensions:

Width: 465 mm (19")  
Height: 44.5 mm (1 U)

#### Material:

Aluminium section with plastic cover

#### Supply includes:

- 1 socket strip PCU 1 U (max. 10 A per socket strip)
- 1 bus cable
- 1 infeed cable 24 V DC
- 1 adaptor for power pack 24 V DC
- 1 connector for power supply
- 1 connection cable 0.3 m with Wieland connector

Designation	Pin pattern	Number of slots	Switchable outputs	With individual current measurement	Depth mm	Model No. DK
IEC 60 320	C13	8	yes	–	60	<b>7200.001</b>
Earthing contact	Earthing pin/C13	4/2	yes	–	60	<b>7856.203<sup>1)</sup></b>
IEC 60 320	C19/C13	4/2	yes	–	60	<b>7856.204<sup>1)</sup></b>
Earthing contact	Earthing pin/C13	4/2	yes	■	160	<b>7859.215</b>
IEC 60 320	C13	8	yes	■	160	<b>7859.225</b>
IEC 60 320	C19/C13	4/2	yes	■	160	<b>7859.235</b>

<sup>1)</sup> Also required: PSM busbars, see page 202.



### Cable entry plates

**For**

- Cable entry grommets
  - Connector grommets
- instead of segments of the standard divided gland plates.

**Material:**

Sheet steel

**Surface finish:**

Zinc-plated

**Supply includes:**

Assembly parts.

**For installation in TS and PC enclosures**

Enclosure width mm	Cut-outs per plate	Packs of	Model No. TS
600	5	2	<b>8800.060</b>
800	8	2	<b>8800.080</b>
1000	4	4	<b>8800.100</b>
1200	6	4	<b>8800.120</b>

**For installation in CM enclosures and TP TopConsole system**

Enclosure width mm	Cut-outs per plate	Packs of	Model No. CM
600	5	1	<b>5001.226</b>
800	8	1	<b>5001.227</b>
1000	4	1	<b>5001.228</b>
1200	6	1	<b>5001.229</b>
1600	8	1	<b>5001.237</b>

**For installation in ES enclosures and TP universal console, CS Basic enclosure**

Enclosure width mm	Cut-outs per plate	Packs of <sup>1)</sup>	Model No. TS
600	5	2	<b>4320.700</b>
800	8	2	<b>4321.700</b>
1000	10	2	<b>4323.700</b>

<sup>1)</sup> Incl. compensating plate

**For TS stainless steel**

**Material:**

Stainless steel 1.4301 (AISI 304)

**For installation in TS, stainless steel**

Enclosure width mm	Cut-outs per plate	Packs of	Model No. TS
600	5	2	<b>8700.600</b>
800	8	2	<b>8700.800</b>
1200	6	4	<b>8700.120</b>



**Accessories:**

Cable entry grommets, see page 512.

**Three examples from a wide range of possibilities**

The diagrams show three TS examples for the positioning of cable entry plates instead of segments of the three-piece gland plates supplied as standard. This facilitates positioning to fit the mounting plate.

Thanks to the enclosure symmetry, where dimensions permit, cable entry plates may also be inserted in the enclosure depth, right and left, analogous to the gland plates.

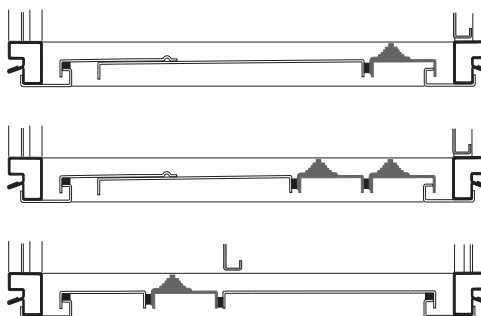
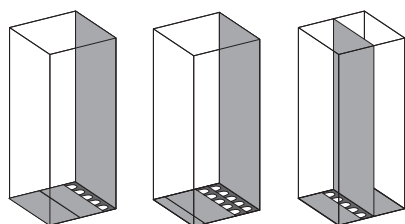

# Cable management

## Cable entry



### Cable entry grommets

In conjunction with the cable entry plate, simple and fast sealing of cables inserted in the base area of enclosures.

**Material:**

- Body: Polypropylene
- Cover: Thermoplastic elastomer

**Protection category:**

IP 55 subject to correct mounting.

Cables per grommet	Max. Ø mm	Packs of	Model No. PS
8	13	25	<b>4316.000</b>
3	21	25	<b>4317.000</b>
1	47	25	<b>4318.000</b>



### Connector grommets

Suitable for cable diameters from 8 to 36 mm.

**Material:**

- Outer cover: Polypropylene covered with thermoplastic elastomer
- Seal: Cellular rubber

**Protection category:**

IP 55 subject to correct mounting.

Packs of	Model No. PS
10	<b>4311.000</b>



### Section for cable entry, centre for TS, CM, TP

For top-mounting on gland plates. A superior alternative to the foam rubber cable clamp strip, thanks to:

- Easier mounting
- Full-surface support
- High level of sealing of cables inserted into the enclosure

**Material:**

- Extruded aluminium section
- Seal: PU foam
- Cross-section: 30 x 25 mm

**Protection category:**

IP 55 subject to correct mounting.

**Note:**

1 set is sufficient for one base opening up to an enclosure width of 800 mm. From an enclosure width of 1000 mm, two base openings are provided. 2 sets per enclosure may be fitted.



For enclosure width mm	Packs of	Model No. TS
600	1 set	<b>8802.060</b>
800	1 set	<b>8802.080</b>
1000	2 sets	<b>8802.100</b>
1200	2 sets	<b>8802.120</b>
1600	2 sets	<b>8802.160</b>

**+** **Accessories:**

- Cable clamp rails (right angle section), see page 527
- C rail 30/15, see page 465.

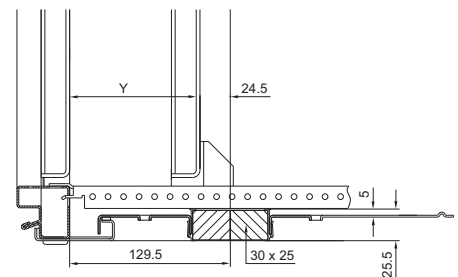

Y = Mounting plate depth-adjustable on a 25 mm pitch pattern (final pitch 30 mm).



### Section for cable entry, rear

#### for TS, CM, TP

Unlike the section for cable entry, centre, the rear section is mounted directly onto the base opening. In this way, when installing the mounting plate in the rearmost position (TS) or with CM, the cables may be routed directly on a cable clamping rail with no large radii. In conjunction with the cable clamp rail, optimum adjustment between the cable entry and mounting plate can be achieved.

#### Material:

- Extruded aluminium section
- Seal: PU foam
- Cross-section: 30 x 25 mm

#### Protection category:

IP 55 subject to correct mounting.

For enclosure width mm	Packs of	Model No. TS
600	1 set	<b>8802.065</b>
800	1 set	<b>8802.085</b>
1000	2 sets	<b>8802.105</b>
1200	2 sets	<b>8802.125</b>
1600	2 sets	<b>8802.165</b>

#### Note:

1 set is sufficient for one base opening up to an enclosure width of 800 mm. From an enclosure width of 1000 mm, two base openings are provided. 2 sets per enclosure may be fitted.



#### Accessories:

Cable clamp rail, see page 527.



### Foam rubber cable clamp strip

For sealing the cable entry between the gland plates. Particularly suitable for identical cable cross-sections.

#### Material:

- PU foam
- Cross-section: 30 x 30 mm

#### Protection category:

IP 55 subject to correct mounting.

Packs of	Model No. SZ
3 m	<b>2573.000</b>



### EMC gland plates

see page 499.



# Cable management

## Gland plates



### Plastic gland plates

#### With metric knockouts

With pre-punched holes for cable glands.  
Used for sealing standard gland plates.

#### Temperature range:

May be used from  $-40^{\circ}\text{C}$  to  $+70^{\circ}\text{C}$ .

#### Colour:

RAL 7035

#### Note:

The applicable size may be taken from the respective product ordering page.

Size	Packs of	Model No. SZ
1	10	<b>2560.010</b>
3	10	<b>2561.010</b>
4	5	<b>2562.010</b>
5	5	<b>2563.010</b>

Size 1

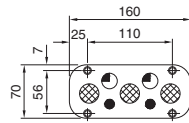

Size 3

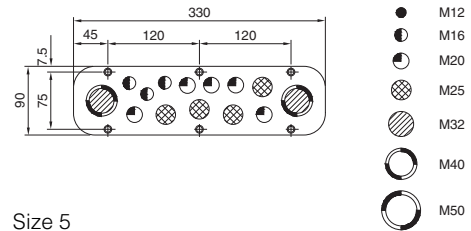

Size 4

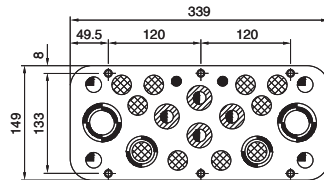

Size 5

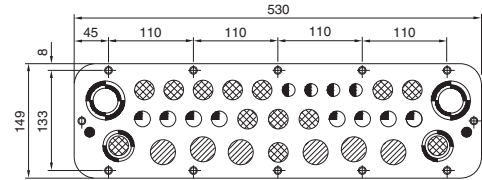

### Plastic gland plates

#### With PG knockouts

With pre-punched PG holes for cable glands.  
Used for sealing standard gland plates.

#### Temperature range:

May be used from  $-40^{\circ}\text{C}$  to  $+70^{\circ}\text{C}$ .

#### Material:

ABS

#### Colour:

RAL 7035

#### Note:

The applicable size may be taken from the respective product ordering page.

Size	PG	Qty.	Packs of	Model No. KL
2	13.5	12	5	<b>1581.000</b>
	13.5	6	5	<b>1582.000</b>
	16	2		
	21	2		

**KL 1581.000**

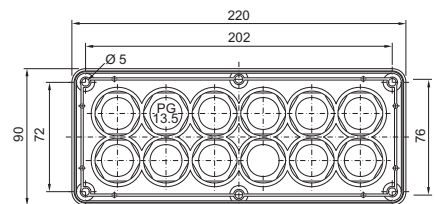

**KL 1582.000**

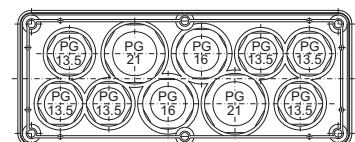

# Cable management

## Gland plates

### Plastic gland plates

#### with membranes

Simply pierce the plastic with a sharp object, and pull through the cable.

#### Material:

Plastic to UL 94-V0

#### Colour:

Similar to RAL 7035

#### Protection category:

IP 65 with careful cable entry.

#### Note:

The applicable size may be taken from the respective product ordering page.

Size 3

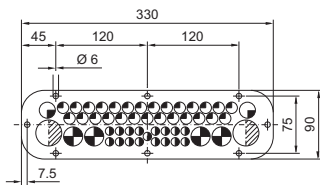

Size 4

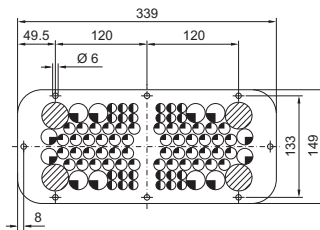

Size	Packs of	Model No. SZ
3	1	2561.500
4	1	2562.500
5	1	2563.500

	Diameter mm	Number of cable entries for Model No. SZ		
		2561.500	2562.500	2563.500
●	5 – 9	–	–	18
◐	6 – 11	17	–	–
◑	7 – 12	–	24	16
◒	10 – 15	27	48	36
◓	15 – 21	2	4	–
◔	15 – 24	–	–	6
◕	15 – 25	–	8	–
◖	16 – 25	4	–	–
◗	19 – 34	2	–	–
◘	23 – 30	–	–	2
◙	26 – 35	–	4	2
◚	26 – 54	–	–	4
○	50 – 110	–	–	1

Size 5

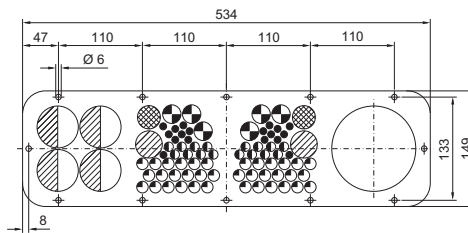

# Cable management

## Gland plates



### Metal gland plates

#### With metric knockouts

Simply knock out the holes for the cable glands using a screwdriver.

**Material:**  
Sheet steel

**Colour:**  
RAL 7035

**Protection category:**  
IP 66 when mounting in the usual position at the bottom.

**Note:**  
The applicable size may be taken from the respective product ordering page.

Size 2

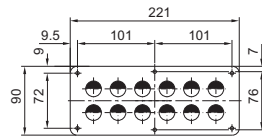

Size 3

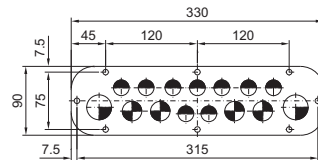

Size 4

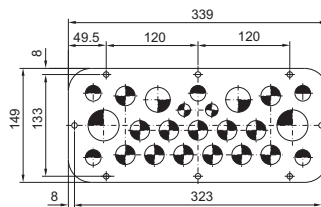

Size	Packs of	Model No. SZ
2	1	1581.100
3	1	2561.100
4	1	2562.100
5	1	2563.100

Number of cable entries

Diameter						Model No. SZ
M12	M16	M20	M25	M32	M40	
–	–	12	–	–	–	1581.100
–	–	9	4	2	–	2561.100
–	2	5	13	2	2	2562.100
1	–	12	11	8	4	2563.100

#### + Accessories:

Cable glands made from polyamide or brass, see page 519.

Size 5

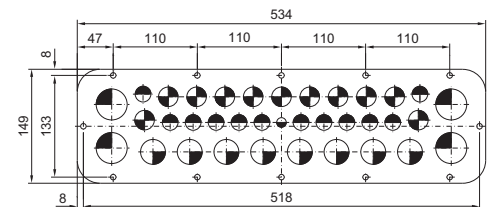

# Cable management

## Gland plates

### Metal gland plates

As spare/replacement part for the standard gland plates supplied loose.

**Material:**  
Sheet steel

**Colour:**  
RAL 7035

**Protection category:**  
IP 66 when mounting in the usual position at the bottom.

**Note:**  
The applicable size may be taken from the respective product ordering page.

### + Accessories:

Cable glands made from polyamide or brass, see page 519.

Size	Design	Packs of	Model No. SZ/IN/KL
1	Solid	1	2560.400
2	Solid	6	1158.500
3	Solid	1	2561.400
4	Solid	1	2562.400
5	Solid	1	2563.150



#### SZ 2560.400

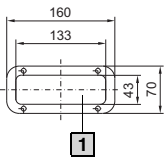

#### IN 2563.150

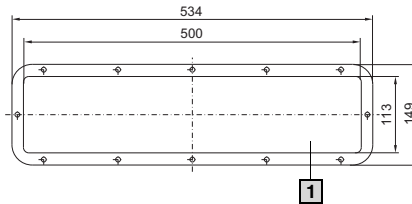

#### SZ 2561.400

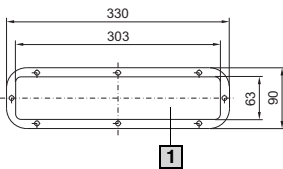

#### KL 1158.500

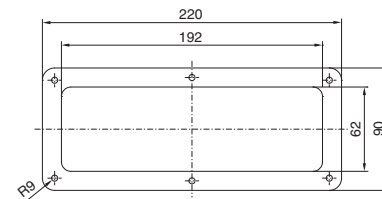

#### SZ 2562.400

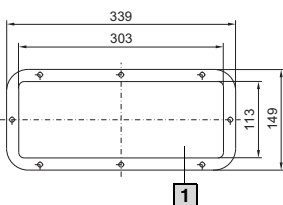

**1** Area available for population

### Gland plate

**solid, for QuickBox**

To conceal the cable entry openings. In exchange for the brush strip at the top and bottom that is used as standard.

**Material:**  
Sheet steel

**Colour:**  
RAL 7035

**Supply includes:**  
Assembly parts.

Packs of	Model No. QB
2	7502.310



### Gland plate

**for metric cable glands, for EL**

Folded gland plate with foamed-in seal and pre-punched, knock-out holes for metric cable glands M12, M20, M25, M32, M40.

**Material:**  
Sheet steel, 1.5 mm

**Colour:**  
RAL 7035

**Protection category:**  
IP 55 to IEC 60 529

Packs of	Model No. DK
1	7705.235

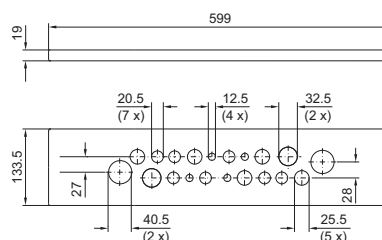

# Cable management

## Gland plates



### Gland plate

#### solid, for EL

Folded gland plate for the base box, with foamed-in seal.

#### Material:

Sheet steel, 1.5 mm

#### Colour:

RAL 7035

Packs of	Model No. EL
1	2235.135

Extended delivery times.



### Gland plate

#### with brush insert, for EL

Folded gland plate with foamed-in seal and plastic brush inserts for simple cable entry.

#### Material:

Sheet steel, 1.5 mm

#### Colour:

RAL 7035

Packs of	Model No. DK
1	7705.035

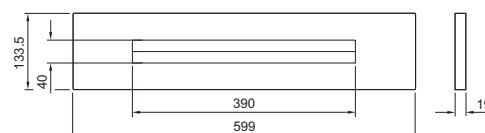

### Brush strip

For individual installation of enclosure panels, gland plates and panels. Cut-outs for cable routing at any given positions in the side panel, rear panel, doors, roof and gland plate may be finished off attractively by simply attaching the brush strip.

Packs of	Model No. DK
2 m	7072.200

#### Technical specifications:

- For metal thickness: 0.6 – 1.5 mm
- Bristle length: 30 mm
- Plastic sheathing: 18 mm
- Snap-on surface: 10 mm
- Maximum cut-out height: 38 mm



### Brush strip, super-airtight

For individual installation of enclosure panels, gland plates and panels. Cut-outs for cable routing at any position in the side panel, rear panel, doors, roof and base plate.

These special brush strips may be used to create airtight entries for cable sections and conductors. The brush strips arranged in an offset configuration ensure good sealing from the routed cables even with large quantities of cables. In this way, unwanted system losses may be reduced to a minimum.

Packs of	Model No. DK
2 x 1 m	7825.375

#### Technical specifications:

- For metal thickness: 1.5 – 2 mm
- Bristle length: 58 mm
- Plastic sheathing: 14 mm
- Snap-on surface: 11.5 mm
- Cut-out width: 88 – 90 mm

#### Material:

Plastic, UL 94-V0

#### Supply includes:

1 brush strip each, 1 m in length, right-hand and left-hand version.

# Cable management

## Cable glands

### Cable gland, brass

Benefits:

- Because the gland and lock nut are sold together in a single pack, this saves additional ordering and storage.
- Clamping membranes for even tightening and strain relief which protects the cables.
- Insulation via plastic insert.
- Optimum seal on the connection thread, thanks to O-ring.
- The lock nut cuts automatically into the spray-finish, thereby creating a conductive connection.

**Material:**

- Brass
- Seal: Neoprene

**Surface finish:**

Nickel-plated

**Protection category:**

- IP 68 (5 bar, 30 min.) to IEC 60 529
- IP 69K to DIN 40 050-9

**Approval:**

VDE tested to EN 50 262

- 1** Cap nut
- 2** Neoprene seal
- 3** Plastic insert
- 4** O-ring
- 5** Lock nut

Size	Cable diameter mm	Packs of	Model No. SZ
M12 x 1.5	3 – 6.5	15	<b>2411.800</b>
M16 x 1.5	4.5 – 10	15	<b>2411.810</b>
M20 x 1.5	6 – 12	10	<b>2411.820</b>
M25 x 1.5	11 – 17	10	<b>2411.830</b>
M32 x 1.5	15 – 21	5	<b>2411.840</b>
M40 x 1.5	19 – 28	4	<b>2411.850</b>
M50 x 1.5	27 – 38	2	<b>2411.860</b>
M63 x 1.5	34 – 44	1	<b>2411.870</b>

**↔ Possible alternative:**

Cable gland Hygienic Design, see page 521.

**+** **Accessories:**

- Sealing bungs, see page 520.
- Multi-seal inserts, see page 520.

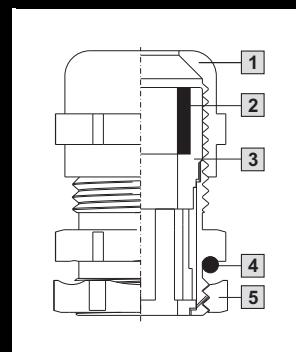

### Cable gland, polyamide

Benefits:

- Because the gland and lock nut are sold together in a single pack, this saves additional ordering and storage.
- Clamping membranes for even tightening and strain relief which protects the cables.
- Spray-moulded sealing lip ensures an optimum seal against the enclosure.
- Trapezoid thread for secure screw-fastening of the cap nut.

**Material:**

Polyamide 6, neoprene seal

**Colour:**

RAL 7035

**Protection category:**

IP 68 (5 bar, 30 min.) to IEC 60 529

**Approval:**

- VDE tested to EN 50 262
- CSA for USA and Canada

- 1** Cap nut
- 2** Neoprene seal
- 3** Trapezoid thread
- 4** Sealing lip
- 5** Lock nut

Size	Cable diameter mm	Packs of	Model No. SZ
M12 x 1.5	3 – 6.5	50	<b>2411.600</b>
M16 x 1.5	4.5 – 10	50	<b>2411.610</b>
M20 x 1.5	6 – 12	50	<b>2411.620</b>
M25 x 1.5	11 – 17	25	<b>2411.630</b>
M32 x 1.5	15 – 21	15	<b>2411.640</b>
M40 x 1.5	19 – 28	5	<b>2411.650</b>
M50 x 1.5	27 – 38	5	<b>2411.660</b>
M63 x 1.5	34 – 44	3	<b>2411.670</b>

**+** **Accessories:**

- Polyamide reducers, see page 520.
- Sealing bungs, see page 520.
- Multi-seal inserts, see page 520.

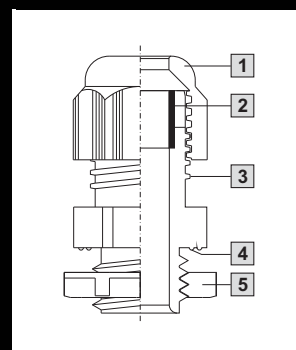

# Cable management

## Cable glands



### Polyamide reducers

#### for polyamide cable glands

For adapting metric cable glands to larger diameter holes or threads.

#### Benefit:

Reducer and locking nut are sold together in a single pack; this saves additional ordering and storage.

#### Material:

Polyamide 6 GF30

#### Colour:

RAL 7035

#### Note:

Polyamide cable gland, see page 519.

#### Thread

Exterior	Inside	Packs of	Model No. SZ
M16 x 1.5	M12 x 1.5	50	<b>2411.550</b>
M20 x 1.5	M12 x 1.5	50	<b>2411.551</b>
M20 x 1.5	M16 x 1.5	50	<b>2411.552</b>
M25 x 1.5	M16 x 1.5	50	<b>2411.553</b>
M25 x 1.5	M20 x 1.5	50	<b>2411.554</b>
M32 x 1.5	M16 x 1.5	50	<b>2411.555</b>
M32 x 1.5	M20 x 1.5	50	<b>2411.556</b>
M32 x 1.5	M25 x 1.5	50	<b>2411.557</b>
M40 x 1.5	M25 x 1.5	25	<b>2411.558</b>
M40 x 1.5	M32 x 1.5	25	<b>2411.559</b>
M50 x 1.5	M40 x 1.5	5	<b>2411.560</b>
M63 x 1.5	M40 x 1.5	5	<b>2411.561</b>
M63 x 1.5	M50 x 1.5	5	<b>2411.562</b>



### Sealing bung

#### for cable glands M20 x 1.5

For use in all situations where pre-installed cable glands M20 x 1.5 must be kept free for future installations but properly sealed. Simply loosen the cap nut, mount the sealing bung, and retighten.

#### Material:

Polyamide 6

#### Colour:

RAL 7035

Packs of	Model No. SZ
25	<b>2411.532</b>



### Multi-seal inserts

For the secure entry of several individual cables into a single cable gland.

#### Material:

Neoprene

Size	Cable diameter mm	Number of cables	Packs of	Model No. SZ
M25	3	7	25	<b>2411.504</b>
	4	6	25	<b>2411.505</b>
	5	4	25	<b>2411.506</b>
	6	3	25	<b>2411.507</b>



# Cable management

## Cable glands

### Cable gland HD

#### Applications:

- Manufacturing and packaging of foodstuffs etc.
- Clean room technology (e.g. pharmaceuticals)
- Biotechnology
- Chemical industry

#### Benefits:

- Smooth, solid exterior surfaces effectively prevent the depositing of harmful micro-organisms.
- Much easier, and therefore cheaper to clean compared with conventional cable glands.

#### Material:

- Cap nut: Stainless steel 1.4305 (AISI 303)
- Seal: Conforms to FDA 21 CFR 177.2600

#### Protection category:

- IP 68 (5 bar, 30 min.) to IEC 60 529
- IP 69K to DIN 40 050-9

#### Standard version

Size	Cable diameter mm	Packs of	Model No. HD
M12 x 1.5	3 – 6.5	5	<b>2410.000</b>
M16 x 1.5	4.5 – 10	5	<b>2410.010</b>
M20 x 1.5	6 – 12	5	<b>2410.020</b>
M25 x 1.5	11 – 17	5	<b>2410.030</b>

#### EMC version

Size	Cable diameter mm	Packs of	Model No. HD
M16 x 1.5	5 – 10	5	<b>2410.110</b>
M20 x 1.5	6 – 12	5	<b>2410.120</b>
M25 x 1.5	12 – 17	5	<b>2410.130</b>

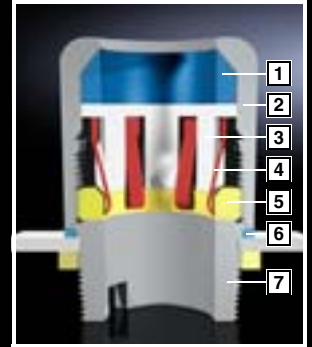

### Why hygiene-compatible cable glands?

#### Critical points with conventional solutions

- 1 Cable entry in front of seal
- 2 No minimum radii on the hexagon
- 3 External thread
- 4 Gap caused by O-ring on the enclosure surface

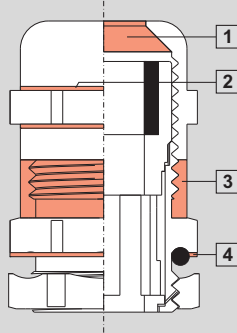

#### Hygiene-compatible design features

- 1 Seal directly at the cable entry
- 2 Compliance with minimum radii on the hexagon
- 3 No external thread
- 4 Flush termination between the cap nut and the enclosure

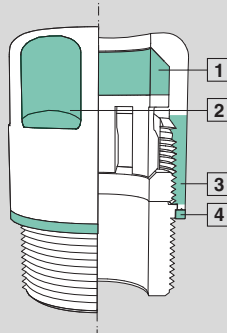

- 1 Seal
- 2 Cap nut
- 3 Gripper jaws
- 4 Shield spring (EMC version only)
- 5 Clamping ring
- 6 Enclosure seal
- 7 Base with locator for assembly tool

### Stainless steel lock nut

To match HD cable glands.

#### Material:

Stainless steel 1.4305 (AISI 303)

Size	Packs of	Model No. HD
M12 x 1.5	10	<b>2410.200</b>
M16 x 1.5	10	<b>2410.210</b>
M20 x 1.5	10	<b>2410.220</b>
M25 x 1.5	10	<b>2410.230</b>



### Assembly tool

#### for HD cable glands

For attaching HD cable glands in an internal thread or using lock nuts. This can be achieved either from the inside or from the outside using an Allen key.

#### Supply includes:

1 set = Adaptor for sizes from M12 – M25.

Packs of	Model No. HD
1 set	<b>2410.290</b>



# Cable management

## Cable glands



### Cable glands

#### for fibre-optic technology

The common size PG 13.5 has a slotted interior seal. This allows super-easy cable entry. Ideal for routing break-out cables, as this eliminates unnecessary bending of the fibre-optic cables.

#### Material:

- Cable gland: Brass
- Inner seal: Soft PVC insert

#### Surface finish:

Cable gland: Nickel-plated

Fibre-optic cable gland	Cable diameter mm	Packs of	Model No. DK
PG 13.5	2 x 3	12	7455.030

### Connector gland

#### for connector cut-outs (24-pole)

For the entry of 2 pre-assembled cables in the connector cut-out, without dismantling the connector.

For cable diameter from 8 – 36 mm.

#### Material:

- Enclosure: Plastic
- Clamps: Sheet steel

#### Surface finish:

Clamps: Zinc-plated

Packs of	Model No. SZ
1 set	2400.000

#### Supply includes:

1 set =  
2 half-shells, including seals, with fastening clamp.

### Cable gland

#### for IW worktops

To fit drilled holes Ø 60 mm. For the entry of cables with pre-assembled connectors, the rotating flap and cover are easily removed.

#### Material:

Plastic

#### Colour:

RAL 7035

Packs of	Model No. IW
1	6902.770

#### Detailed drawings:

Available on the Internet.

### Edge protector

For covering sharp edges of cut-outs. Provides protection from injuries and prevents damage to inserted cables. The edge protector is suitable for material thicknesses of approx. 1.0 – 2.0 mm, and may be cut to length individually.

#### Material:

Plastic PVC

#### Colour:

Black

Packs of	Model No. DK
10 m	7072.100

# Cable management

## Cable glands



The Rittal connector gland proves that sometimes "less is more": significantly faster installation, a flexible sealing system for different cable diameters, and simple cable entry with pre-assembled cables. Low installation costs, a high degree of protection and flexible cable management – added value guaranteed with the latest generation of cable entry solutions from Rittal.

### Benefits:

- Cable diameters 4 – 16 mm
- Simple cable entry for pre-assembled cables
- Individual cables can be added or replaced without dismantling the sealing frame
- Sealing modules remain safely attached to their cables

## Sealing frame

For pre-assembled cables with connectors.

Mounting over 24-pole or 16-pole connector cut-outs in:

- Module plates for TS divider panels
- Metal gland plates

### Material:

- Front panel: Polyamide
- Flat seal: CR

### Protection category:

IP 64 to IEC 60 529, complies with NEMA 12.

### Supply includes:

Assembly parts.

For modules 20 x 20 mm	For cut-out	Packs of	Model No. SZ
10	24-pole	1	<b>2400.900</b>
8	16-pole	1	<b>2400.910</b>



### Accessories:

Module plates for TS divider panel, see from page 390.

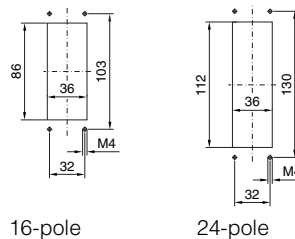

16-pole

24-pole

## Sealing module

To seal cables in conjunction with a sealing frame. It is possible to combine 20 x 20 mm and 40 x 40 mm sealing modules.

### Material:

- Hard shell: Polyamide
- Seal: TPE 2

### Protection category:

IP 64 to IEC 60 529, complies with NEMA 12.

### Sealing modules 20 x 20 mm

Diameter range	Packs of	Model No. SZ
4 – 6 mm	10	<b>2400.920</b>
6 – 9 mm	10	<b>2400.930</b>
Solid	10	<b>2400.970</b>

### Sealing modules 40 x 40 mm

Diameter range	Packs of	Model No. SZ
9 – 12 mm	10	<b>2400.940</b>
12 – 16 mm	10	<b>2400.950</b>
Solid	10	<b>2400.960</b>



# Cable management

## Cable glands



### Connector gland, small

For pre-assembled cables with connectors.

- For use with material thickness of up to 4 mm.
- Strain relief of the pre-assembled cables can be achieved with cable ties.

**Material:**

Plastic

**Colour:**

RAL 9005

**Protection category:**

IP 65 subject to correct mounting.

**Supply includes:**

Assembly parts.

To fit	Packs of	Model No. SZ
2 cables Ø 6 to Ø 8 mm	1	<b>2400.300</b>
3 cables Ø 4 to Ø 6 mm	5	<b>2400.500</b>

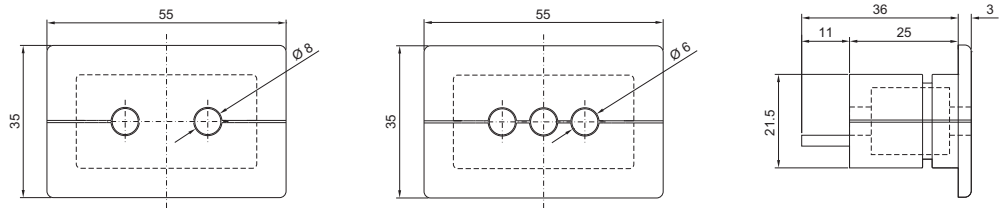

SZ 2400.300

SZ 2400.500

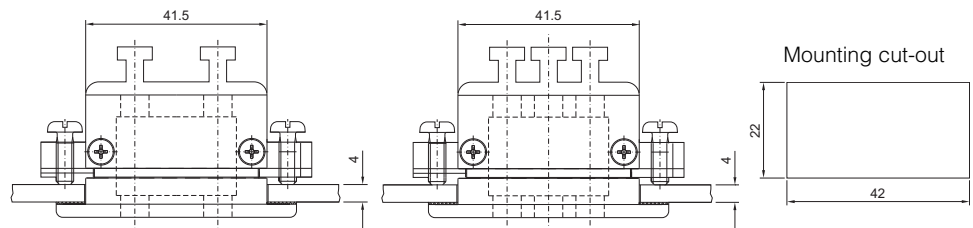

Mounting cut-out

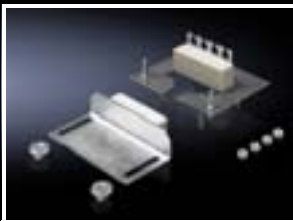

### Cable gland module

**CP-L, Ø 130 mm**

Use of the support arm cut-out CP-L, round, with enclosures mounted on the wall, for sealed cable entry. May also be mounted retrospectively with the cables already inserted.

Fitted with T-heads for cable clamping. Particularly well-suited to cables with identical cross-sections.

**Material:**

Sheet steel

**Surface finish:**

Zinc-plated

**Supply includes:**

Assembly parts.

Packs of	Model No. CP
1	<b>6052.500</b>

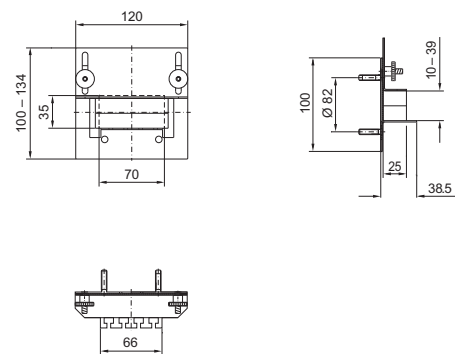

### Stepped collar

**For wall thicknesses from 1.5 to 4.5 mm**

For cable entry, simply cut off at the required level to match the cable diameter.

**Material:**

Plastic to UL 94-HB

**Protection category:**

IP 54 with careful cable entry.

For hole	Sealing range mm	Packs of	Model No. SZ
M20	5 – 16	100	<b>2899.200</b>
M25	5 – 21	50	<b>2899.250</b>
M32	13 – 26.5	25	<b>2899.320</b>
M40	13 – 34	20	<b>2899.400</b>

# Cable management

## Cable duct

### for vertical TS section

For direct mounting on the vertical enclosure section.

#### Width 50 mm

For assembly on a vertical enclosure section in the area of the side panel.

#### Width 100 mm

For assembly on two bayed enclosure profiles in the baying area. Baying brackets and baying clamps which have already been fitted can be covered over with the cable duct.

The nominal break points of the members are also oriented towards combination with the cable ducts for mounting plates; in addition a further nominal break at the level of the mounting plate enables direct insertion into the cable duct.

The cable duct fastening points are co-ordinated with the TS system hole pattern; elaborate drilling, as in the case of DIN ducts, is dispensed with.

Width mm	Height mm	Packs of	Model No. TS
50	1600	8 sets	<b>8800.570</b>
50	1800	8 sets	<b>8800.520</b>
100	1600	4 sets	<b>8800.540</b>
100	1800	4 sets	<b>8800.510</b>

#### Technical specifications:

- Depth: 80 mm
- Length: 1600 mm (for enclosure height 1800 mm)  
1800 mm (for enclosure height 2000 mm)  
May be shortened for other enclosure dimensions
- Bar width: 5.5 mm
- Slot width: 4.5 mm

#### Material:

- Hard PVC
- Flame-resistant, self-extinguishing
- Temperature resistant to +60°C

#### Colour:

Similar to RAL 7030

#### Supply includes:

- 1 set = 1 cable duct with cover.



#### Accessories:

Aluminium rivet for attachment, see page 526.

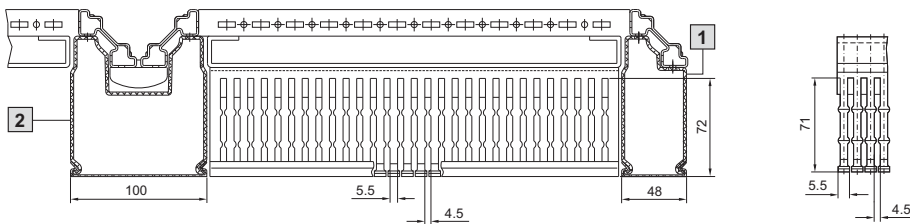
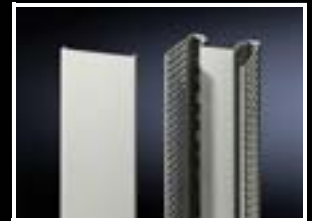
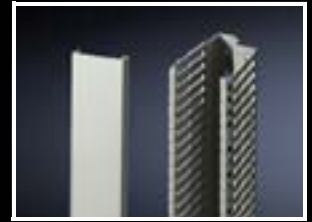

**1** TS 8800.570/TS 8800.520

**2** TS 8800.540/TS 8800.510

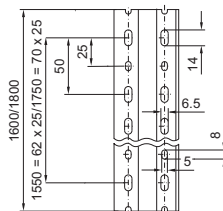
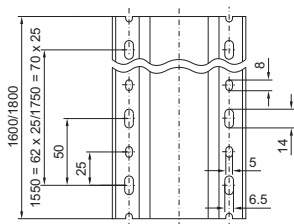

# Cable management

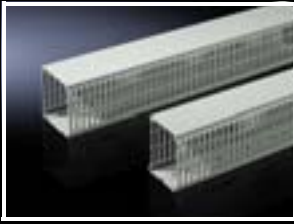

## Cable duct for mounting plate

- To fit the cable ducts for vertical TS sections. If the TS mounting plate is installed in the rear-most position, the horizontally mounted cable ducts are flush with the vertical ones.
- For external mounting on surfaces.

For enclosure width mm		Fixed length 2000 mm
Length (L) mm		
Width (B) mm	Packs of	Model No. TS
30	24 sets	<b>8800.750</b>
40	20 sets	<b>8800.751</b>
60	18 sets	<b>8800.752</b>
80	12 sets	<b>8800.753</b>
100	12 sets	<b>8800.754</b>

Width 30, 40 and 60 mm

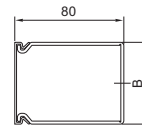
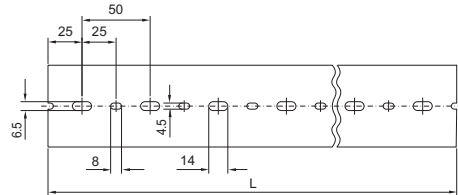

Width 80 and 100 mm

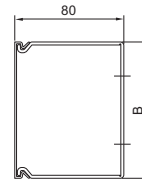
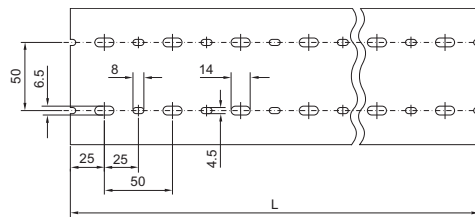

## Aluminium rivet

For secure assembly of cable ducts in conformity with the relevant standards. Also suitable for mounting support rails and punched rails.

To fit:

- TS system punchings
- Drilled hole  $\varnothing$  4.5 mm.

Packs of	Model No. TS
100	<b>8800.531</b>

### Accessories:

- Cable ducts for vertical TS section, see page 525.
- Cable ducts for mounting plate, see page 526.

# Cable management

## Cable clamp rails

### Mounting angle for TS, ES, PC, TP universal console, base/plinths

For strain relief with cable entry. Depth-variable mounting on a 25 mm pitch pattern on the horizontal enclosure section or in side base/plinth trim panels with assembly bolts.

**Material:**  
Steel

**Surface finish:**  
Zinc-plated

**Supply includes:**  
Assembly parts.

Enclosure width mm	Length mm	Packs of	Model No. PS
400	385	2	4193.000
600	585	2	4191.000
800	785	2	4192.000
1000	985	2	4336.000
1200	1185	2	4196.000
1600	1585	2	4338.000
1800	1785	2	4339.000

### + Accessories:

Assembly bolts for base/plinth, see page 364.



## Cable clamps,

### for cable clamp rails

For fastening the cables to the cable clamp rails.

**Material:**  
Sheet steel

**Surface finish:**  
Zinc-plated

**Supply includes:**  
Plastic insert.

For cable diameter mm	Packs of	Model No. SZ
6 – 12	25	2350.000
12 – 16	25	2351.000
14 – 18	25	2352.000
18 – 22	25	2353.000
22 – 26	25	2354.000
26 – 30	25	2355.000
30 – 34	25	2356.000
34 – 38	25	2357.000
38 – 42	25	2358.000
42 – 46	25	2359.000
46 – 50	25	2360.000

### ⇌ Possible alternative:

Rail for EMC shielding bracket and strain relief, see page 498.



## Cable clamp rails

### C section for TS, CM, TP

For strain relief with cable entry. The length of the cable clamp rail is tailored to the width of the mounting plate. The mounting bracket included with the supply supports three different installation situations on the mounting plate:

- 1 straight, at a distance of 23 mm from the mounting plate
- 2 straight, at a distance of 10 mm from the mounting plate
- 3 tilted, towards the mounting plate

**Material:**  
Sheet steel

**Surface finish:**  
Zinc-plated

**Supply includes:**  
Two mounting brackets and assembly screws.

For enclosure width mm	Length mm	Packs of	Model No. CM
600	499	1	5001.080
800	699	1	5001.081
1000	899	1	5001.082
1200	1099	1	5001.083

### + Accessories:

Cable clamps for C rails, see page 529.

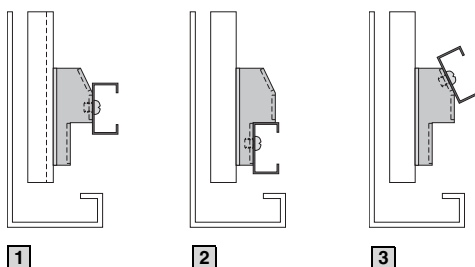

# Cable management



## Cable clamping bracket

For installing in the operating housing with mounting cut-out CP-L and CP-XL.

Cable clamping optionally via:

- Cable clamps
  - or
  - Cable tie SZ 2597.000
  - Commercially available cable ties.
- Bracket height = 25 mm with fitted C rail 40 mm.

**Material:**  
Sheet steel

**Surface finish:**  
Zinc-plated

**Supply includes:**  
C rail and screws.

Packs of	Model No. CP
1 set	6052.000

### + Accessories:

- Cable clamps, see page 529.
- Cable ties, see page 530.

## Cable clamp rails

see page 532.

## Combination rails

### for QuickBox

For cable clamping and routing.

Cables and leads can be fastened to the hammer heads top and bottom with cable ties. In addition, the C section of the combination rail will accommodate cable clamps with inserts. For producing a contacting connection, the anodised coating of the rail must be broken.

**Material:**  
Aluminium

**Surface finish:**  
Anodised

**Supply includes:**  
Assembly parts.

For enclosure depth mm	Length mm	Packs of	Model No. QB
300/400	200	6	7502.302
500/600	400	6	7502.304

For enclosure width mm	Length mm	Packs of	Model No. QB
600	400	6	7502.304

### + Accessories:

- Cable clamps, see page 529.
- Cable ties, see page 530.



## Cascade cable routing

### for chassis mounting for TS

Professional cable routing system for cascading of cables in several levels of the enclosure depth. The cables are attached to the C rail by means of clamps. Suitable for installation on the inner enclosure level.

**Material:**  
Sheet steel

**Surface finish:**  
Zinc-plated

**Supply includes:**  
– 6 mounting brackets  
– 3 C rails  
– Assembly parts

For enclosure width mm	Packs of	Model No. DK
600	3	7831.570
800	3	7831.571

### + Accessories:

- TS punched section with mounting flange for the inner mounting level, see page 459.
- PS punched section without mounting flange for vertical mounting in the enclosure frame, see page 464.
- Cable clamps, see page 529.



## Cable clamps

### for C rails

For attaching the cables to the C rails.

**Material:**  
Sheet steel

**Surface finish:**  
Zinc-plated

**Supply includes:**  
Plastic insert.

**Note:**  
C rails,  
see from page 465.

For cable diameter mm	Packs of	Model No. DK
6 – 14	25	7077.000
12 – 18	25	7078.000
18 – 22	25	7097.000
22 – 26	25	7097.220
26 – 30	25	7097.260
30 – 34	25	7097.300
34 – 38	25	7097.340
38 – 42	25	7098.000
42 – 56	25	7098.100
56 – 64	25	7099.000



## Cable conduit and cable conduit holder

For secure cable routing e.g. from the enclosure or mounting plate to the door. Attachment facility for standard commercially available cable ties is provided on the cable conduit holder, so that cables may be attached upon entry to/exit from the cable conduit.

**Material:**  
– Cable conduit: Polythene  
– Cable conduit holder: Polyamide

### Cable conduit

Internal Ø mm	Packs of	Model No. SZ
16	25 m	2595.000
29	25 m	2589.000
36	25 m	2596.000
48	25 m	2590.000

### Cable conduit holder

For cable conduit Ø mm	Packs of	Model No. SZ
16	20	2593.000 <sup>1)</sup>
29	20	2591.000 <sup>1)</sup>
36	20	2594.000
48	20	2592.000

<sup>1)</sup> Installation in compact enclosures AE with universal bracket SZ 2373.000, see page 476.



# Cable management



## Cable attachment

For professional, secure fastening of cables and conduits.

For fastening:

- Slide into the mounting rail 23 x 23 mm,
- Screw-fasten onto the round punchings of the enclosures, as well as all punched rails and punched sections.

As the fastening attachments are bayable, several fastening attachments, even those of different sizes, can be assembled by using just 2 screws.

### Material:

Polyamide

### Note:

Punched rail 23 x 23 mm, see page 463.

For cable diameter from – to mm	Packs of	Model No. PS
6 – 9	50	<b>4319.090</b>
9 – 12	50	<b>4319.120</b>
12 – 16	50	<b>4319.160</b>
16 – 20	50	<b>4319.200</b>



### Also required:

Posidrive raised countersunk screw M5 x 12 mm, SZ 2488.000, for screw-fastening to the round system punchings, see page 478.



## Cable ties

The super-fast solution for fastening cables to the enclosure profile or mounting system parts. Simply clip into the round system punchings.

Length mm	Packs of	Model No. SZ
150	100	<b>2597.000</b>



## Nylon loop

With the nylon loop, secured cables are easily released, allowing individual cables to be added or removed. Ideal for sensitive data cables (fibre-optic/Cu), as it avoids indentations on the cable sheathing.

In addition, the nylon loop may be screw-fastened to the round system punchings or attached using a quick-release fastener.

### Colour:

Black

### Supply includes:

Quick-release fastener.

Width mm	Length mm	Max. cable diameter mm	Packs of	Model No. DK
20	130	30	10	<b>7072.220</b>
20	200	50	10	<b>7072.230</b>
20	300	90	10	<b>7072.240</b>



### Also required:

Screw SZ 2486.500 for screw-fastening to the round system punchings, see page 478.



## Nylon loop

For tidy cable routing. Supplied on a reel for cutting to the required length.

Unlike cable ties,

- protects the cable sheathing
- easily reopened
- reusable

Length mm	Width mm	Packs of	Model No. IN
5000	16	1	<b>2203.400</b>

## Nylon loop cable holder

### self-adhesive

Suitable for universal use in all network enclosures and server racks, wall-mounted enclosures, mounting plates and gland plates.

### Material:

Woven polyamide 6.6

### Colour:

Black

Size length x width mm	Packs of	Model No. DK
70 x 16	10	7111.350



## Cable tie fastener

### for round system punchings and VIP 6000

For all commercially available cable ties up to a tie width of 4.8 mm.

Simply insert into the screw channel and secure by hammering down the split rivet.

### Material:

Polyamide 6.6

Packs of	Model No. CP
100	6059.000



## Cable tie fastener

### for Comfort Panel, Optipanel and Compact Panel

For secure cable routing of all standard commercially available cable ties up to a tie width of 4.0 mm.

Simply insert into the T channel and secure by rotating through 45°.

### Material:

Polyamide 6.6

Packs of	Model No. CP
100	6059.500

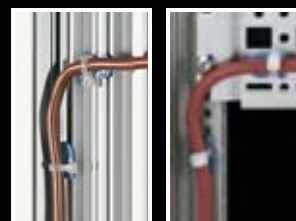

## Cable tie fastener

### for Comfort Panel, Optipanel and Compact Panel

For secure cable routing of all standard commercially available cable ties up to a tie width of 4.0 mm.

Simply insert into the T channel and secure by rotating through 45°.

### Material:

Polyamide 6.6

Packs of	Model No. CP
100	6059.500



## Snap-in cable routing

### for clipping into the system punchings

Cable routing suitable for universal use, for toolless, fast assembly, in two variants:

For locking:

- User-friendly opening for cable management via locating points
- For cable diameters 14 – 19 mm
- For system punchings 6.2 mm

For twisting:

- User-friendly opening for cable management
- For cable diameters 10.2 – 12.7 mm
- For system punchings 4.7 mm

### Material:

Polyamide 6.6, self-extinguishing to UL 94-V2

### Colour:

Natural

Design	Packs of	Model No. DK
For locking for system punchings 6.2 mm	10	7111.300
For twisting for system punchings 4.7 mm	10	7111.310

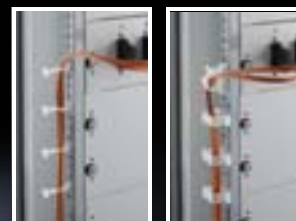
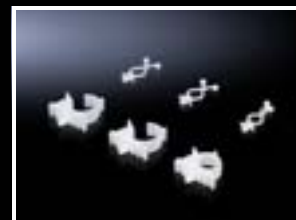

# Cable management



## Cable clamp rails

### for TS and 482.6 mm (19") mounting frames

The cables may be attached to the cable clamp rails with cable ties or nylon tapes. The cable clamp rails are simply located onto the frame section and may additionally be secured with a screw.

**Material:**  
Sheet steel

**Supply includes:**  
Assembly parts.

#### For the inner mounting level

For enclosures		Packs of	Model No. DK
Width mm	Depth mm		
600	600	4	<b>7828.061</b>
800	800	4	<b>7828.081</b>
1000	1000	4	<b>7828.101</b>
1200	1200	4	<b>7828.121</b>

#### For the outer mounting level

For enclosures		Packs of	Model No. DK
Width mm	Depth mm		
600	600	4	<b>7828.062</b>
800	800	4	<b>7828.082</b>
1000	1000	4	<b>7828.102</b>
1200	1200	4	<b>7828.122</b>

#### + Accessories:

- Cable ties, see page 530.
- Nylon loop, see page 530.



## Cable clamp rails, depth-variable

### for TS and 482.6 mm (19") mounting frames

For strain relief of the routed cables. The cables may be attached to the cable clamp rails with cable ties or nylon tapes.

The cable clamp rails may be located directly on a 482.6 mm (19") mounting frame horizontally at the rear or in the enclosure depth between two mounting frames. An additional screw fastening secures the unit.

The depth variability of the rails facilitates flexible adaptation of their length to the existing attachment distance between the two 482.6 mm (19") mounting frames.

**Material:**  
Sheet steel

**Supply includes:**  
Assembly parts.

Mounting dimension <sup>1)</sup> mm	Packs of	Model No. DK
325 – 575	4	<b>7858.160</b>
500 – 895	4	<b>7858.162</b>

<sup>1)</sup> Mounting dimensions + 120 mm = distance between 482.6 mm (19") levels

#### + Accessories:

- Cable ties, see page 530.
- Nylon loop, see page 530.



1

## Cable clamp, variable

### for enclosure-independent mounting

Variable attachment from 450 to 800 mm for flexible cable clamping in two variants.

Supports attachment to punched sections with and without mounting flanges and direct screw-fastening onto mounting plates and other flat surfaces.

**Material:**  
Sheet steel, zinc-plated

**Supply includes:**  
Assembly parts.

Design	Packs of	Model No. DK
C rail	1	<b>7016.140</b>
T-head rail	1	<b>7016.150</b>

- 1 C rail
- 2 T-head rail



2

# Cable management

## Cable manager

For system-compatible cable deflection while complying with minimal bending radii and to accommodate surplus cables and excess length. The elements may optionally be used individually or in combination for cable routing. They may be combined into semi-circular or circular elements. As the mounting distance between the elements grows larger, the deflection radius of the cables may optionally be enlarged, or the cable route designed individually. The option of securing elements on their straight-edge side supports the use of corners and edges, to allow protected cable routing around them.

Mounting clips for use above the arc hold the routed cables back within the elements. The elements are also bayable in an axial direction to allow U-based cable routing to the mounting level, or channelling of the cable sections.

**Material:**

Plastic, UL 94-V0

**Colour:**

RAL 7035

**Supply includes:**

Mounting clips and assembly parts.

	Packs of	Model No. DK
Basic kit	8	7064.100
Maxi kit	20	7064.110

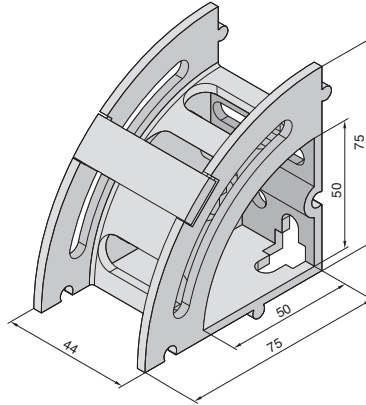

## Shunting ring, plastic

For flexible cable routing, in two materials and three size variants.

Option of mounting on the 482.6 mm (19") enclosure and swing frame section of the data distributor, on all patch panels, on the Rittal Data Rack and all components on a 25 mm DIN pitch pattern.

**Polyamide version:**

Infinitely variable mounting thanks to a longitudinal slot. The shunting ring DK 7218.035 may also be used on 1 U patch panels.

**Colour:**

RAL 7035

Material	Dimensions mm	Packs of	Model No. DK
1 Polyamide	70 x 44	10	7218.035
1 Polyamide	105 x 70	10	7219.035
2 Polycarbonate	95 x 50	10	7228.035



**Polycarbonate version:**

Variable mounting. With 45° attachment, the cable shunting ring may be attached to a 1 U panel.

**Colour:**

RAL 7035



**Possible alternative:**

Cable management panel, 1 U, see page 539.



# Cable management



## Cable shunting ring

For flexible, system-compatible cable routing at the side of the 482.6 mm (19") mounting frame or on 482.6 mm (19") mounting angles.

**Material:**  
Sheet steel, zinc-plated

**Supply includes:**  
Assembly parts.

Dimensions mm	Packs of	Model No. DK
125 x 85	10	7111.900
125 x 65	10	7111.000
85 x 43	10	7112.000



## Anti-twist guard

### for cable shunting rings

For individual attachment of cable shunting rings (DK 7111.000, DK 7111.900, DK 7112.000) to mounting angles, mounting frames or enclosure panels. May be mounted on a 25 mm pitch pattern of system punchings on mounting angles and on the 10.5 x 12.5 mm system punchings of the 482.6 mm (19") mounting frame. It may be variably mounted and rotated on the system punchings in 90° increments.

Form-fit accommodation of the shunting ring into the integral channel allows large forces to be accommodated in all directions.

**Material:**  
Plastic

**Colour:**  
RAL 7035

Packs of	Model No. DK
10	7111.100



## Shunting ring

To accommodate large quantities of cables. Shunting ring for side attachment to 482.6 mm (19") sections and mounting frames in 800 mm wide network enclosures.

The ring is attached asymmetrically providing approx. 110 mm free space in front of the 482.6 mm (19") level. This allows even large quantities of cables to be effectively managed.

**Material:**  
Round steel, zinc-plated

**Supply includes:**  
Assembly parts.

Dimensions mm	Packs of	Model No. DK
330 x 90/70	4	7220.600



## Fibre-optic shunting rings

The inner body is grooved, and fibre-optic shunting or jumper cables can be inserted into these. A rubber ring holds different fibre-optic cables with diameters of up to 4.5 mm. Strain relief and bending radius are ensured. Length: 120 mm.

### Material:

Dual compound plastic

### Colour:

- Exterior: RAL 7035
- Interior: Black

### Supply includes:

- 2 rubber rings
- Baying kit
- Mounting accessories

### Assembly:

The supplied mounting brackets are suitable for universal use; the fibre-optic cables can be routed to the patch panel in all directions in various mounting positions:

- 1** At the side, directly on the patch panel
- 2** In front of the patch panel
- 3** At the side next to the patch panel
- 4** In front of the patch panel

Packs of	Model No. DK
2	7116.500

### Possible alternative:

Fibre-optic cable management panel, 1 U, see page 541.



## Cable clamp strap

### for patch panels

To provide strain relief of incoming or outgoing data cables. Optionally available with spring brackets for accommodating and contacting the cable screen. Connection to the patch panel is by means of bolts on the panel itself.

### Material:

Sheet steel, 2 mm, zinc-plated

### Supply includes:

Assembly parts.

Design	Packs of	Model No. DK
Without cable screen contact	1	7610.000
With spring clips for contacting the cable screen	1	7611.000



## System supports for cable routes

### for TS

The depth-variable support system may be attached to all 800 – 1200 mm deep TS enclosures with external screw-fastening of the roof plate. The integral system punchings, for screws or captive nuts, support the attachment of most common cable route systems.

### Material:

Sheet steel

### Surface finish:

Powder-coated

### Colour:

RAL 7035

Packs of	Model No. DK
2	7831.472

### Accessories:

- Metal multi-tooth screws 5.5 x 13 mm, SZ 2486.500, see page 478.
- Captive nuts M6, TS 8800.340, see page 477.



# Cable management



## Cable route on the mounting frame

The mounting kit facilitates rear, side attachment of a cable tray to mounting frames inside enclosure systems TE 7000, TS. This allows the integration of vertical cable management independently of the enclosure frame.

**Material:**  
Sheet steel, zinc-plated

Packs of	Model No. DK
1	7000.685

**Supply includes:**  
1 cable route 100 mm wide, 1700 mm high, including mounting kit.

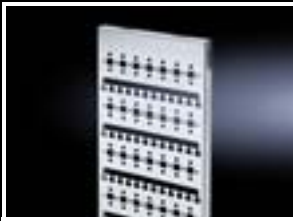

## Cable route, vertical for TS

For direct attachment between the roof and base frame of a 2000 mm high frame structure. Installation position optionally on the inner or outer mounting level. Route width 200 mm. With integral system punchings for the attachment of various cable routing aids and hammer-head attachment for nylon loops and cable ties.

**Material:**  
Sheet steel, zinc-plated

**Supply includes:**  
Assembly parts.

Packs of	Model No. DK
1	7858.200

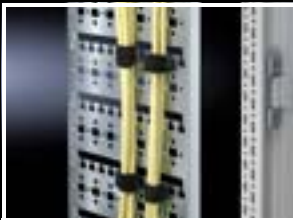

## Cable route for TS

For cable routing between two 482.6 mm (19") mounting angles in bayed enclosure suites (enclosure width 800 mm, mounting angles fitted centrally). Suitable for L-shaped and cranked mounting angles.

**Material:**  
Sheet steel

**Colour:**  
RAL 7035

**Supply includes:**  
Assembly parts.

Packs of	Model No. DK
1	7827.050



## Surplus cable holder

For fastening at the rear area of the enclosure, or at the side of network enclosures. The surplus cable holder can be attached to all depth stays or to punched sections and rails with a 25 mm pitch pattern – mounting dimension 150 mm. Units may also be fastened to each other.

**Material:**  
Sheet steel

**Colour:**  
RAL 7035

W x H x D mm	Packs of	Model No. DK
280 x 151 x 75	1	7220.500





# Cable management

## Cable routing 482.6 mm (19")

### Cable routing bars

For structured routing of entire cable bundles, the cable bars may be secured to a variety of different positions inside the enclosure.

#### Material:

- Support: Sheet steel
- Cable routing bars, connection combs: Plastic

#### Colour:

RAL 9005

#### Supply includes:

- Cable routing bars
- Connection combs



### 482.6 mm (19") attachment

For horizontal cable routing within the distributor level.

Thanks to their open mounting holes, they can also be retrospectively slotted onto the 482.6 mm (19") system punchings of the mounting level at any time and secured with the existing mounting screws of the installed components.

U	No. of connection combs	Packs of	Model No. DK
4	2	4	7111.224
1	5	10	7111.214



### All-round attachment for universal use

For vertical and horizontal cable routing inside the enclosure or within the distributor level.

U	No. of connection combs	Packs of	Model No. DK
4	2	4	7111.222
1	5	10	7111.212



### Cranked attachment

For mounting angles and mounting frames.

Horizontal, U-based cable routing to the distributor level.

U	No. of connection combs	Packs of	Model No. DK
4	2	4	7111.220
1	5	10	7111.210



### Connection comb

For connecting individual cable routing bars into complete systems (included with the supply).

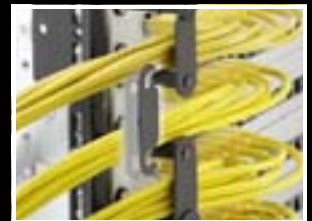

# Cable management

## Cable routing 482.6 mm (19")



### Cable duct

#### for TS/TE

For laying cable in particularly high packaging densities (high density network nodes), in the optical fibre or copper cabling sector.

Large capacity. A wide range of cable routing, cable clamping, channelling and cross-cabling options creates the requirements for maximum port density in the minimum possible space. Individual U-based cable routing makes it possible to dispense with additional cable routing via patch panels within the distributor level, thereby equipping every U with connection points. This increases port density by up to 50%.

The removable duct cover, hinged on both sides, facilitates user-friendly access at any time. The cable sections are held back by removable cross-bars to protect them against falling out. Mounting is either on mounting rails at the sides, and on mounting angles and mounting frames in the 482.6 mm (19") distributor level. Two ducts may also be secured back-to-back.

#### Material:

- Cable duct: Sheet steel, spray-finished
- Cable routing components: Plastic
- Front trim panel: Aluminium, spray-finished

#### Colour:

RAL 7035

#### Supply includes:

Hinged front trim panel and assembly parts.

Size W x D mm	No. of U	Packs of	Model No. DK
95 x 235	24	1	<b>7827.310</b>
	42	1	<b>7827.320</b>

#### Note:

When using the duct in conjunction with 482.6 mm (19") mounting frames and TS 8, the inner mounting level in the vicinity of the cable duct is not available.

Within the duct, additional cable ties may be attached to accommodate spare cables and for system-compatible cable deflection.

#### + Accessories:

Cable ties for spare cables:

	Packs of	Model No. DK
<b>1</b>	4	<b>7827.330</b>

### Distributor clip

#### Material:

Sheet steel

#### Surface finish:

Zinc-plated

#### Supply includes:

Assembly parts.

#### 1 Distributor clip

For structured cable routing of entire cable bundles, the distributor clip may be secured to a variety of different positions inside the enclosure. It may be used for both horizontal and vertical distribution of the cables.

#### 2 Distributor clip, horizontal

For mounting angles and mounting frames. Distribution of cables among the various height units of the patch level.

	Packs of	Model No. DK
<b>1</b>	4	<b>7111.252</b>
<b>2</b>	4	<b>7111.250</b>

# Cable management

## Cable routing 482.6 mm (19")

### Drawer 482.6 mm (19")

#### to accommodate surplus cables

The 1 U drawer offers a convenient opportunity for storing surplus cables in an organised, compact and secure way within the 482.6 mm (19") levels.

- With brush strip at the front for cable entry
- T-head rail in the rear section for cable clamping
- Ring-shaped kink-free routing of the conductors on adjustable elements in the interior
- May be fitted between two 482.6 mm (19") levels at a distance of 435 – 750 mm
- Independent from the enclosure system
- Both on L-shaped and cranked mounting angles and mounting frames.

Distance between levels mm	Packs of	Model No. DK
435 – 750	1	7063.200

**Material:**  
Sheet steel

**Colour:**  
RAL 7035

**Supply includes:**  
Drawer including telescopic slides and assembly parts.



#### Accessories:

Nylon loop DK 7072.220/DK 7072.230, see page 530.



### Cable management panel

#### 482.6 mm (19")

For horizontal management of the patch cables, with 5 cable shunting rings.

#### Material:

- Panel: Sheet steel
- Ring: Polyamide

**Colour:**  
RAL 7035

U	Ring size mm	Packs of	Model No. DK
1	70 x 44	1	7159.035 <sup>1)</sup>

<sup>1)</sup> Cable shunting rings supplied loose.



#### Material:

- Panel: Sheet steel
- Ring: Polycarbonate

**Colour:**  
RAL 7035

U	Ring size mm	Packs of	Model No. DK
1	95 x 50	1	7255.035 <sup>1)</sup>

<sup>1)</sup> Cable shunting rings supplied loose.



#### Material:

- Panel: Sheet steel
- Ring: Steel

**Surface finish:**  
Ring: Zinc-plated

**Colour:**  
RAL 7035

U	Ring size mm	Packs of	Model No. DK
1	105 x 43	1	7257.035
2	125 x 85	1	7257.100
1	43 x 55	1	7257.200

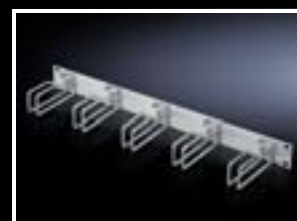

#### Material:

- Panel: Sheet steel
- Ring: Steel

**Surface finish:**  
Ring: Zinc-plated

**Colour:**  
RAL 9005

U	Ring size mm	Packs of	Model No. DK
1	105 x 43	1	7257.005
2	125 x 85	1	7257.105 <sup>1)</sup>

<sup>1)</sup> Extended delivery times.



#### Note:

The sizes given are external dimensions.

# Cable management

## Cable routing 482.6 mm (19")

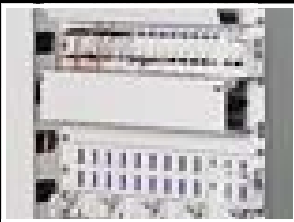

### Cable management panel with cable routing bars

#### 482.6 mm (19")

For horizontal management of the patch cables with cable routing bars. Opening the individual cable routing bars allows user-friendly modification and extension of the cabling.

#### Material:

- Panel: Sheet steel, spray-finished
- Cable routing bars: Plastic

#### Colour:

- Panel: RAL 7035
- Cable routing bars: Black

U	Bar depth mm	No. of bars/U	Packs of	Model No. DK
1	Approx. 80	5	1	<b>7257.050</b>
2	Approx. 80	4	1	<b>7257.150</b>

### Cable management panel, 2 U

#### 482.6 mm (19")

The cable routing chamber has cut-outs from above, into which the patch cables can be inserted. The cable management panel is equipped with a flap and quick-release fasteners at the front, for optimum access to the cables. From the rear, the cables can be inserted via a cut-out with brush strips. With accommodation facility for cable clamp straps DK 7610.000 or DK 7611.000.

#### Material:

Sheet steel

#### Colour:

RAL 7035

U	Depth mm	Packs of	Model No. DK
2	85	1	<b>7158.035</b>



#### Accessories:

Cable clamp strap, see page 535.

### Cable routing channel

#### 482.6 mm (19")

To hold the patching cables.

#### Material:

Sheet steel

#### Colour:

RAL 7035

U	Depth mm	Packs of	Model No. DK
1	85	1	<b>7149.135</b>
3	100	1	<b>7149.035</b>

### Cable management panel, 2 U

#### 482.6 mm (19")

To accommodate fibre-optic and copper cables. Fibres from the patch panels are placed into the tray via openings and may be distributed at the sides. Rounded openings protect the cable sheathing.

#### Material:

Sheet steel

#### Colour:

RAL 7035

U	Packs of	Model No. DK
2	1	<b>7269.135</b>

# Cable management

## Cable routing 482.6 mm (19")

### Cable management duct, horizontal

#### 482.6 mm (19")

The duct facilitates concealed, simple cable routing of large quantities of cables to equipment within the 482.6 mm (19") attachment level. Large cut-outs ensure convenient, kink-free cable routing to the components top and bottom. For simple handling, the entire front panel may be removed via quick-release fasteners. After attaching the cables, these are held in position via nylon ties, whilst the duct may be resealed.

**Material:**

Sheet steel

**Colour:**

RAL 7035

**Supply includes:**

5 nylon loops.

U	Packs of	Model No. DK
2	1	7158.100
3	1	7158.150 <sup>1)</sup>

<sup>1)</sup> Extended delivery times.



### Cable tray, 2 U

For side routing and distribution of fibre-optic and copper cables. In this way, cables inserted into the roof area may be routed at the side of the mounting angles in the upper section of the rack. Depth 85 mm.

**Material:**

Sheet steel

**Colour:**

RAL 7035

U	Packs of	Model No. DK
2	1	7269.235



### Fibre-optic cable management panel, 1 U

#### 482.6 mm (19")

The four fibre-optic cable shunting rings integrated into the front permit optimum management of up to 48 fibres.

**Material:**

- Panel: Sheet steel
- Ring: Dual compound plastic

**Colour:**

- Panel: RAL 7035
- Cable shunting rings on the outside: RAL 7035, black interior

U	Packs of	Model No. DK
1	1	7256.035

 **Possible alternative:**

Fibre-optic support guide DK 7116.500, see page 535.



# Cable management

## Cable routing 482.6 mm (19")

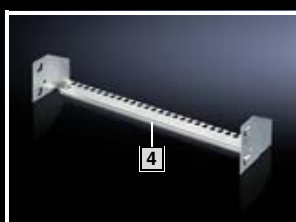
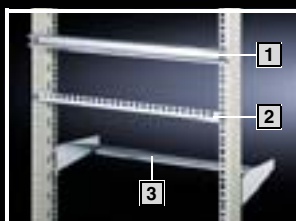
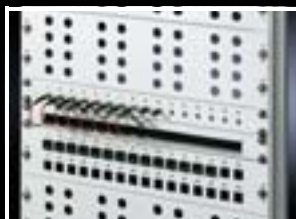

### Cable entry panel

#### 482.6 mm (19")

Cut-out 390 x 40 mm (2 U) or 390 x 20 mm (1 U) with brush insert. With accommodation facility for cable clamp straps DK 7610.000 or DK 7611.000.

**Material:**  
Sheet steel

**Colour:**  
RAL 7035

U	Packs of	Model No. DK
1	1	7140.535
2	1	7150.535

#### + Accessories:

Cable clamp strap, see page 535.

### Cable routing across the 482.6 mm (19") mounting level

There are various different cable clamping systems available for system-compatible cable routing in 482.6 mm (19") systems with one or two pairs of mounting angles:

**Material:**  
Sheet steel

**Surface finish:**  
Zinc-plated

- 1 C rail**  
for mounting between all pairs of 482.6 mm (19") mounting angles.

C rail	Depth in mm	Packs of	Model No. DK
482.6 mm (19") level	–	6	7016.100

- 2 Cable clamp rails**  
for mounting between all pairs of 482.6 mm (19") mounting angles, for cable ties.

Cable clamp rail	Depth in mm	Packs of	Model No. DK
482.6 mm (19") level	–	6	7016.110

- 3 Cable clamp straps for large swing frames, and Data Rack,**  
the cable clamp straps are mounted on the frame at the rear, whilst the cables are clamped 250 mm behind the 482.6 mm (19") mounting angles.

Cable clamp strap for	Depth in mm	Packs of	Model No. DK
Data Rack and large swing frame	250	6	7016.120
DK-TS mounting angles	100	6	7016.130

- 4 Cable clamp strap for DK-TS mounting angles,**  
with side lugs for suspending from the cranked 482.6 mm (19") mounting angles. Cable clamping is via cable ties.

#### ! Also required:

With L-shaped TS mounting angles, adaptor DK 7827.300 is additionally required, see page 488.

# 482.6 mm (19") installation system

## Swing frame

### Swing frame, small

#### Installation for 600 mm and 800 mm wide enclosures

For mounting 482.6 mm (19") equipment.

#### Material:

Sheet steel

#### Surface finish:

Zinc-plated

#### Supply includes:

Cam with double-bit lock insert and parts for attaching to the installation kit.

#### Technical information:

Available on the Internet.



Installation	Front, top/bottom	Set back, top/bottom	Set back/front, centre
U	Packs of	<b>Model No. SR</b>	
3	1	<b>2377.030</b>	
6	1	<b>2377.060</b>	
9	1	<b>2377.090</b>	
12	1	<b>2377.120</b>	
15	1	<b>2377.150</b>	
18	1	<b>2377.180</b>	

#### Also required:

		For enclosure width			
		600	800		
<b>1</b>	Installation kit	1 set			
		<b>2377.860</b>	<b>2377.880</b>		
<b>2</b>	PS punched section without mounting flange, 2 or 4 required	For enclosure depth mm		Page	
		400	4	4374.000	464
		500	4	4375.000	464
		600	4	4376.000	464
		800	4	4377.000	464
	Support bracket, 2 required per PS punched section without mounting flange	6 sets		8800.330	473
<b>Accessories</b>					
	Lock inserts, type D			2484.000	421

#### Note:

The swing frame stay is required to lock the open swing frame, see page 548.

### Installation kit

for swing frame, small in ES, TP universal console.

Enclosure width mm	Packs of	Model No. SR
600	1 set	<b>2377.460</b>



#### Accessories:

- Depending on the installation position:
- Support bracket PS 4183.000, see page 473 and
  - PS punched section without mounting flange in accordance with the enclosure depth, see page 464.



# 482.6 mm (19") installation system

## Swing frame



### Vario swing frames

#### Installation for ES and CS modular enclosures, 800 mm wide enclosures

For the installation of 482.6 mm (19") equipment.

**Material:**  
Sheet steel

**Colour:**  
RAL 7035

#### Supply includes:

Double-bit lock insert and assembly parts.

#### Technical information:

Available on the Internet.

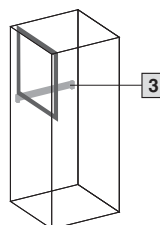
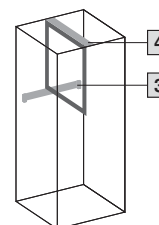
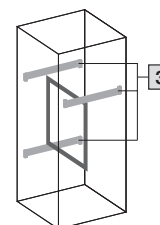
Installation	Front <sup>1)</sup> , top	Set back, top	Set back/front <sup>1)</sup> , centre
			
U	Packs of	<b>Model No. SR</b>	
6	1	<b>2004.235</b>	
12	1	<b>2008.235</b>	
18	1	<b>2011.235</b>	

#### Also required:

	For enclosure mm			Page
PS punched section with mounting flange	 400 depth	4	8800.640	464
	 500 depth	4	8800.650	464
	 800 width	4	4365.000	464

#### Accessories

Lock inserts, type D		2484.000	421
----------------------	--	----------	-----

<sup>1)</sup> Max. installation depth for enclosure depth 400 mm: 305 mm  
Max. installation depth for enclosure depth 500 mm: 405 mm



# 482.6 mm (19") installation system

## Swing frame

### Swing frame, large

Without trim panel, for 600 mm and 1200 mm wide enclosures

For mounting 482.6 mm (19") equipment.

#### Material:

Sheet steel

#### Surface finish:

Zinc-plated

#### Supply includes:

Cam with double-bit lock insert and parts for attaching to the installation kit.

#### Technical information:

Available on the Internet.



Installation	Full installation, front/set back	Partial installation top, front/set back	Partial installation centre, front/set back

For enclosure width mm			600	1200
U	For min. enclosure height mm	Packs of	<b>Model No. SR</b>	
22	1200	1	<b>2322.700</b>	
31	1600	1	<b>2331.700</b>	
36	1800	1	<b>2336.700</b>	
40	2000	1	<b>2340.700</b>	
45	2200	1	<b>2345.700</b>	

Accessories		Page
Lock inserts, type D	2484.000	421

#### Also required:

##### 1) Installation kits

For enclosure			Hinge	Load capacity	Model No.	Packs of	
TS	ES	CM					
-	-	■	130°	< 800 N	<b>1985.500</b>	1 set	
■	■	-		< 1500 N <sup>2)</sup>	<b>1994.835</b>	1 set	
■	■	-		< 1500 N <sup>2)</sup>	-	<b>1996.835</b>	1 set
■	-	-		< 1500 N <sup>1)</sup>	-	<b>1996.535</b>	1 set

<sup>1)</sup> Installation only possible with the mounting plate slide rail dismantled.

<sup>2)</sup> Maximum load 800 N with the TS mounting plate slide rail dismantled.

##### 2) For TS:

TS punched section with mounting flange 23 x 73 mm, 2 or 4 required

Installation in enclosure depth mm	Packs of	Model No. TS	Page
400	4	8612.140 <sup>1)</sup>	459
500	4	8612.550	460
600	4	8612.560	460
800	4	8612.580	460
1000	4	8612.500	460
1200	4	8612.520	460

<sup>1)</sup> TS punched section with mounting flange, 17 x 73 mm

##### 2) For ES:

PS punched section with mounting flange 23 x 73 mm, 2 or 4 required

Installation in enclosure depth mm	Packs of	Model No. TS	Page
400	4	4369.000	464
500	4	4370.000	464

#### Note:

The swing frame stay is required to lock the open swing frame, see page 548.

# 482.6 mm (19") installation system

## Swing frame



### Swing frame, large

**With trim panel, for 800 mm wide enclosures**

For mounting 482.6 mm (19") equipment.

**Material:**

Sheet steel

**Surface finish:**

- Front panel: Zinc-plated
- Trim panel: Spray-finished

**Colour:**

RAL 7035

**Supply includes:**

Locking rod system with double-bit lock insert and parts for attaching to the installation kit.

**Technical information:**

Available on the Internet.

Installation	Full installation, width 800 mm, front/set back	Partial installation top, width 800 mm, front/set back	Partial installation centre (in the height), width 800 mm front/set back

Mounting position	side	central

With hinge	130°/180°	180°
For enclosure width mm	800	

U	For min. enclosure height mm	Packs of	Model No. SR	
22	1200	1	<b>2323.235</b>	<b>2324.235</b>
31	1600	1	<b>2332.235</b>	-
36	1800	1	<b>2337.235</b>	<b>2338.235</b>
40	2000	1	<b>2341.235</b>	<b>2342.235</b>
45	2200	1	<b>2346.235</b>	<b>2347.235</b>

Heavy-duty version <sup>1)</sup>			Model No. SR	
U	For enclosure height mm	Packs of	<b>7858.100</b>	-
40	2000	1		

Accessories	
Ergoform-S lock systems	see page 419
Lock inserts, version A	see page 421

**Also required:**

1) Installation kits	
For enclosure	Hinge
TS ES CM	Load capacity
- - -	< 800 N
■ ■ -	< 1500 N <sup>3)</sup>
■ - -	< 1500 N <sup>2)</sup>
- - ■	< 800 N
■ ■ -	< 1200 N <sup>3)</sup>
■ - -	< 1200 N <sup>2)</sup>

For enclosure			Hinge	Load capacity	Packs of
-	-	-	130°	< 800 N	<b>1986.500</b>
■	■	-		< 1500 N <sup>3)</sup>	<b>1995.235</b>
■	-	-		< 1500 N <sup>2)</sup>	<b>1995.835</b>
-	-	■	180°	< 800 N	<b>1986.500 + 1978.200</b>
■	■	-		< 1200 N <sup>3)</sup>	<b>1997.235</b>
■	-	-		< 1200 N <sup>2)</sup>	<b>1997.835</b>

<sup>1)</sup> Load capacity 350 kg, including installation kit, for enclosure height 2000 mm.

<sup>2)</sup> Installation only possible with the mounting plate slide rail dismantled.

<sup>3)</sup> Maximum load 800 N with the TS mounting plate slide rail dismantled.

**2)** For TS: TS punched section with mounting flange 23 x 73 mm, 2 or 4 required

Installation in enclosure width/depth mm	Packs of	Model No. TS	Page
400	4	8612.140 <sup>1)</sup>	459
500	4	8612.550	460
600	4	8612.560	460
800	4	8612.580	460
1000	4	8612.500	460
1200	4	8612.520	460

<sup>1)</sup> TS punched section with mounting flange, 17 x 73 mm

**2)** For ES: PS punched section with mounting flange 23 x 73 mm, 2 or 4 required

Installation in enclosure width/depth mm	Packs of	Model No. TS	Page
400	4	4369.000	464
500	4	4370.000	464

**Note:**

The swing frame stay is required to lock the open swing frame, see page 548.

# 482.6 mm (19") installation system

## Swing frame

### Compact swing frames

#### for AE

For mounting slide-in electronic equipment, 482.6 mm (19"), across the entire height.

#### Technical specifications:

Torsionally stiff frame, welded from rectangular tube and triple-folded support section.

#### Material:

Sheet steel

#### Colour:

RAL 7035

#### Supply includes:

Double-bit lock insert and assembly parts.

Width mm	600	600	600/760
Height mm	380	600	760
U	6	11	14
Packs of	1	1	1
<b>Model No. SR</b>	<b>2026.200</b>	<b>2027.200</b>	<b>2034.200</b>



#### Accessories:

41 mm lock insert, version C, see page 421.

#### Detailed drawings:

Available on the Internet.

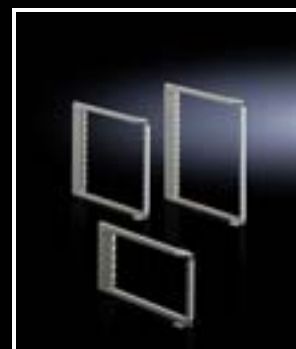

### Pull-out frame, 482.6 mm (19")

#### for TS

For the installation of a pull-out 482.6 mm (19") front. For 600 and 800 mm wide TS enclosures, from a depth of 800 mm.

- Overall depth: 525 mm
- Extension piece: 500 mm
- Distance: 300 mm

#### Load capacity:

50 kg

#### Colour:

RAL 7035

#### Supply includes:

Telescopic slides and assembly parts.

U	Packs of	<b>Model No. DK</b>
12	1	<b>7124.035</b>

#### Note:

The slide rail DK 7963.310 (see page 560) can be mounted directly in the pull-out frame to support heavy equipment.



### Divider kits

#### for pull-out frame

	Enclosure depth mm	Packs of	For enclosure width	
			600 mm	800 mm
<b>Model No. TS</b>				
1 TS punched section with mounting flange	800	4	<b>8612.080</b>	-
	1000	4	<b>8612.000</b>	-
2 Depth stays	800	4	-	<b>7827.800</b>
	1000	4	-	<b>7827.000</b>

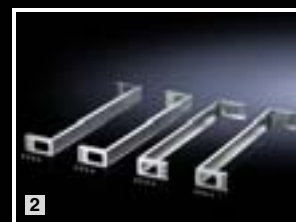
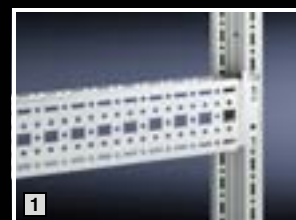

# 482.6 mm (19") installation system

## Swing frame



### Swing frame stay

Holds the swing frame in the open position.

For mounting on:

Swing frame, large

- SR 1979.200, at the top of the enclosure
- SR 1980.200, at the bottom of the enclosure (with safety stop at 160°)

	Packs of	Model No. SR
with 130° hinge	5	<b>1979.200</b>
with 180° hinge	1	<b>1980.200</b>



For mounting on:

Swing frame, small

- SR 1979.200, may be mounted at the top or bottom of the installation kit.

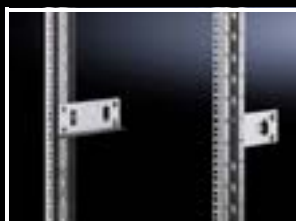

### Slide rails

To support heavy slide-in electronic equipment, 482.6 mm (19") in the swing frame.

**Material:**

Sheet steel

**Surface finish:**

Zinc-plated

For slide-in equipment with max. installation depth	Packs of	Model No. SR
D max. < 190 mm	10	<b>1962.200</b>
D max. > 190 mm	10	<b>1963.200</b>

# 482.6 mm (19") installation system

## Mounting angles

### Mounting angles, 482.6 mm (19")

for TS, CS Toptec

Available in two versions:

#### Cranked

The integral U markings in the front facilitate systematic assembly within the 482.6 mm (19") attachment level.

#### L-shaped

The L-shaped mounting angles accommodate the installation kits of server systems. The integral U markings in the front facilitate systematic assembly within the 482.6 mm (19") attachment level.

#### Technical specifications:

- 2 mm sheet steel
- Integral 482.6 mm (19") punchings (EIA standard)
- Side round and square punchings
- Clear chromated for conductive connection of the 482.6 mm (19") installed equipment.

#### Supply includes:

Assembly parts.

#### Explanation of the mounting dimensions in interior installations:

See page 550.

#### Cranked

Full installation rack height mm	U	Packs of	Model No. DK
800	15	2	7827.080
1000	20	2	7827.100
1200	24	2	7827.120
1400	29	2	7827.140
1600	33	2	7827.160
1800	38	2	7827.180
2000	42	2	7827.200
2200	47	2	7827.220

#### L-shaped

Full installation rack height mm	U	Packs of	Model No. DK
600	11	2	7827.061
800	15	2	7827.081
1000	20	2	7827.101
1200	24	2	7827.121
1400	29	2	7827.141
1600	33	2	7827.161
1800	38	2	7827.181
2000	42	2	7827.201
2200	47	2	7827.221

#### Note:

The mounting angles can also be used to accommodate 21", 23" and 24" attachment dimensions.



#### Also required:

- TS punched sections with mounting flanges or depth stays as installation kit for mounting angles, see page 555 – 556.
- For L-shaped mounting angle variant: for mounting slide rails or component shelves: Adaptor DK 7827.300, see page 488.



### Mounting angles, metric

for TS

The L-shaped mounting angles accommodate metric assemblies and components. Depending on the installation kit, mounting dimensions 465 mm and 515 mm can be configured.

#### Material:

Sheet steel

#### Surface finish:

Zinc-plated

#### Supply includes:

Assembly parts.

#### Explanation of the mounting dimensions in interior installations:

See page 550.

Full installation rack height mm	SU	Packs of	Model No. DK
-	17	2	7831.611 <sup>1)</sup>
1000	37	2	7831.621 <sup>1)</sup>
1200	43	2	7794.420 <sup>1)</sup>
1600	59	2	7794.740 <sup>1)</sup>
2000	76	2	7831.631
2200	84	2	7831.641 <sup>1)</sup>

<sup>1)</sup> Extended delivery times.



#### Also required:

TS punched sections with mounting flanges or depth stays as installation kit for mounting angles, see page 555 – 556.



# 482.6 mm (19") installation system

## Mounting angles

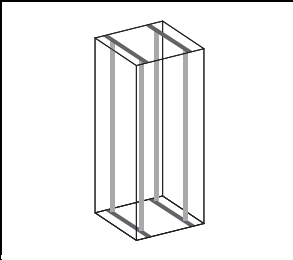

### Mounting frame, 482.6 mm (19")

#### for TS, CS Basic and modular enclosures

The welded 482.6 mm (19") mounting frame may be attached with complete depth variability and is used to structure the front and rear 482.6 mm (19") level.

The mounting frame has the same system punchings as the TS 8 enclosure section at the sides and rear, and therefore supports the mounting of various TS 8 system accessories such as cable clamp rails, cable shunting rings etc.

#### Load capacity:

Up to 1000 kg static load, with even load distribution on two 482.6 mm (19") mounting frames, with full installation.

#### Material:

Sheet steel

#### Surface finish:

Zinc-plated

#### Supply includes:

Assembly parts.

#### Note:

A combination of 482.6 mm (19") mounting frame plus fan mounting plate is not possible. For active ventilation, we recommend use with modular fan roof.

#### Explanation of the mounting dimensions in interior installations:

See page 550.

For enclosures		U	Packs of	Model No. DK
Width mm	Height mm			
600	600	11	1	<b>7856.710</b>
600	1200	24	1	<b>7856.713</b>
600	1800	38	1	<b>7856.716</b>
600	2000	42	1	<b>7856.719</b>
600	2200	47	1	<b>7856.722</b>
800	1200	24	1	<b>7856.725</b>
800	1800	38	1	<b>7856.728</b>
800	2000	42	1	<b>7856.731</b>
800	2200	47	1	<b>7856.734</b>

#### + Accessories:

- Captive nuts, see page 567.
- Assembly screws, see page 478.
- Cable clamp rails TS, see page 532.
- C rails, see page 465.
- Component shelves, see from page 480.
- Fan roof, modular, see page 223.
- TS divider kit, heavy-duty, width/depth-variable, see page 555.

## Explanation of the mounting dimensions in interior installations

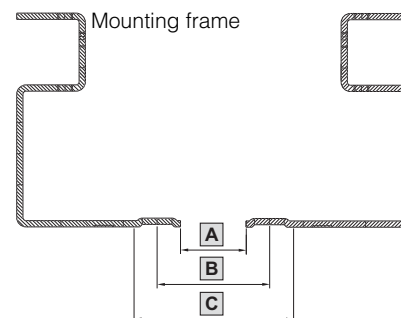
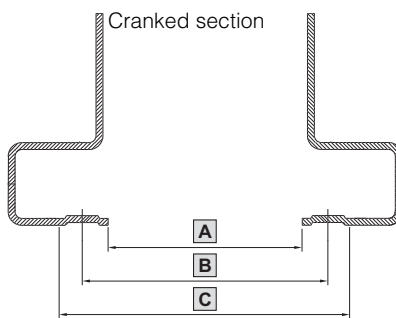

- A** = Clearance width
- B** = Mounting dimension
- C** = External dimension of the rack-mounted equipment or of the front panels

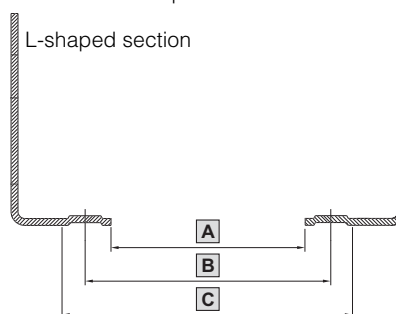

Installation width	<b>A</b> mm	<b>B</b> mm	<b>C</b> mm
≥ 19"	450	465	482.6
≥ 21"	500	515	533.4
≥ 23"	552	567	584.2
≥ 24"	577	592	609.6
≥ 10 <sup>7</sup> /39 HP	221.4	236	254
≥ 1 <sup>1</sup> / <sub>2</sub> 19 <sup>7</sup> /42 HP	236.6	251.2	269.2
≥ 9.5"	208.7	223.3	241.3
≥ 18 SU	450	465	485
≥ 20 SU	500	515	535

# 482.6 mm (19") installation system

## Mounting angles

### Adaptor sections, 482.6 mm (19")

#### for TS

For the installation of subracks and other equipment.

Adaptor sections are easily shortened for partial assemblies.

#### Supply includes:

Assembly parts.

#### Note:

The 482.6 mm (19") measurement is obtained when mounting on the TS frame for enclosures with width 600 mm.



#### Accessories:

- Infill panels, see page 552.
- Captive nuts, see page 477.
- Assembly screws, see page 478.
- Slide rails with one-sided mounting, see page 561.
- Slide rails with two-sided mounting, see page 561.
- Drawer installation kit, see page 563.
- Component shelf installation kit, see page 488.

#### For enclosure system TS<sup>1)</sup>

For enclosure height mm	Material	U	Packs of	Model No. TS
1600	Extruded aluminium section	33	4	<b>8613.060</b>
1800		38	4	<b>8613.080</b>
2000		42	4	<b>8613.000</b>
2200		47	4	<b>8613.020</b>
For PC enclosure <sup>2)</sup>		17	4	<b>8613.070</b>

<sup>1)</sup> For the rear of electronic enclosures, see page 552.

<sup>2)</sup> Behind bottom door.

#### Assembly examples of TS:

##### Drawing 1

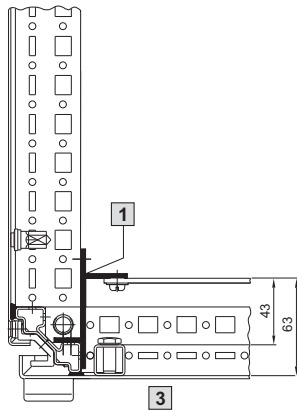

##### Drawing 2

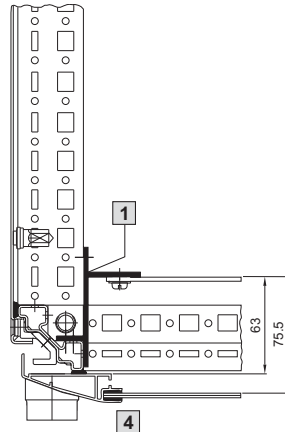

##### Drawing 1 and 2:

Adaptor section or adaptor piece fitted in the foremost installation position, directly on the vertical section. When installing slide rails with two-sided mounting (see page 561), the same adaptor sections or adaptor pieces must also be mounted on the vertical section at the rear.

##### Drawing 3

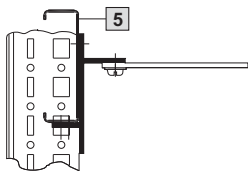

##### Drawing 5

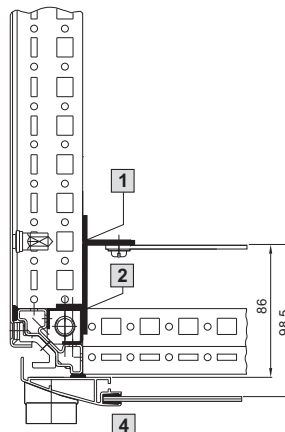

##### Drawing 3:

Mounting on two vertically installed PS punched sections permits fully flexible use of the enclosure depths.

##### Drawing 4

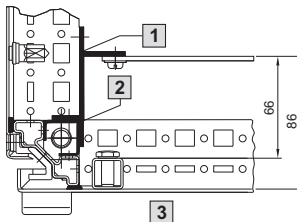

##### Drawing 4 and 5:

Greater distance from the door is achieved by mounting on adaptor rails for PS compatibility. In this position, the slide rails can be fitted with one-sided mounting.

**1** Adaptor section/piece

**2** Adaptor rail

**3** TS sheet steel door

**4** TS glazed door

**5** Punched section without mounting flange

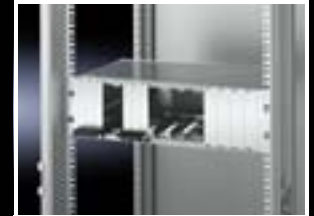

# 482.6 mm (19") installation system

## Mounting angles



### Adaptor pieces, 482.6 mm (19") for TS, ES

The "1 U" sub-section of adaptor sections. For the installation of individual subracks and other equipment.

**Supply includes:**  
Assembly parts.

**Assembly examples:**  
May be found on page 551.

**Note:**  
The 482.6 mm (19") measurement is obtained when mounting on the TS/ES frame for enclosures with width 600 mm. Adaptor set (DK 7246.100) for 800 mm wide enclosures, see page 562.

#### For TS

U	Packs of	Model No. TS
1	4	8613.010

#### For ES

U	Packs of	Model No. PS
1	8	4547.000

#### + Accessories:

- Captive nuts, see page 477.
- Assembly screws, see page 478.
- Slide rails with two-sided mounting, see page 561.
- Drawer installation kit, see page 563.
- Component shelf installation kit, see page 488.

### Adaptor sections, 482.6 mm (19")

**for rear installation in TS electronic enclosures**  
For installing subracks at the front and back, and for attaching the slide rails TS 8613.150, TS 8613.160 and TS 8613.180 (see page 561). Assembly is carried out on the inner mounting level.

The outer mounting level can, e.g. still be used for cable routing on depth-mounted TS punched sections with mounting flange.

**Material:**  
Extruded aluminium section

**Supply includes:**  
Assembly parts.

**Note:**  
Design similar to adaptor sections, 482.6 mm (19") (see page 551), but asymmetrical height, suitable for TS electronic enclosure.

For enclosure height mm	U	Packs of	Model No. TS
1600	33	2	8613.360
2000	42	2	8613.300

#### + Accessories:

- Captive nuts, see page 477.
- Assembly screws, see page 478.
- Slide rails with two-sided mounting, see page 561.
- Drawer installation kit, see page 563.
- Component shelf installation kit, see page 488.

#### ↔ Possible alternative:

Adaptor pieces, 482.6 mm (19"), see page 552.

### Infill panels, 482.6 mm (19"), horizontal

**for adaptor sections**  
To infill between installed 482.6 mm (19") equipment positioned in the full enclosure height and the enclosure clearance height.

**Material:**  
Extruded aluminium section

**Supply includes:**  
Assembly parts.

For enclosure height mm	Packs of	Model No. TS
1600/2000	2	8613.040
1800/2200	2	8613.030



# 482.6 mm (19") installation system

## Mounting angles

### Mounting angles, 482.6 mm (19")

#### for CS basic and modular enclosures

For mounting 482.6 mm (19") components in Outdoor enclosures. The mounting angles are depth-adjustable on a 25 mm pitch pattern. An installation bracket is required to attach the mounting angles.

**Material:**  
Sheet steel

**Surface finish:**  
Zinc-plated

**Supply includes:**  
Assembly parts.

**Explanation of the mounting dimensions in interior installations:** See page 550.

Enclosure height mm	U	Packs of	Model No. DK
800	15	2	<b>7685.000</b>
1200	24	2	<b>7688.000</b>



#### Also required:

Installation bracket PS,  
see page 553.



### Depth stay for PS

#### For mounting angles 482.6 mm (19")

**Material:**  
Sheet steel

**Surface finish:**  
Zinc-plated

Enclosure width mm	Packs of	Model No. DK
600/1200	2	<b>7696.000</b>
800	2	<b>7698.000</b>



### Mounting angles, 482.6 mm (19")

#### for DK-EL

This mounting angle kit allows you to integrate a second 482.6 mm (19") level into EL enclosures.

**Material:**  
Sheet steel

**Colour:**  
RAL 7035

**Supply includes:**  
Assembly parts.

**Explanation of the mounting dimensions in interior installations:** See page 550.

U	Packs of	Model No. DK
6	2	<b>7705.706</b>
9	2	<b>7705.709</b>
12	2	<b>7705.712</b>
15	2	<b>7705.715</b>
18	2	<b>7705.718</b>
21	2	<b>7705.721</b>

Extended delivery times.



# 482.6 mm (19") installation system

## Mounting angles



### Mounting angles, 482.6 mm (19")

#### for QuickBox

For the installation of 482.6 mm (19") rack-mounted equipment.

**Material:**  
Sheet steel

**Colour:**  
RAL 7035

**Supply includes:**  
Assembly parts.

For enclosures U	Packs of	Model No. QB
12	2	7502.203
15	2	7502.204
18	2	7502.205
21	2	7502.206



### Mounting angles, 482.6 mm (19")

#### for FlatBox

L-shaped bracket as 2nd attachment level.

**Material:**  
Sheet steel

**Supply includes:**  
Assembly parts for fast, toolless assembly.

U	Packs of	Model No. DK
6	2	7507.706
9	2	7507.709
12	2	7507.712
15	2	7507.715
18	2	7507.718
21	2	7507.721

**Note:**

The 2nd attachment level should always be ordered in the same height as the basic enclosure. Partial configuration is not possible.



### Mounting angles, 482.6 mm (19")

#### for VerticalBox

For mounting at the side of the VerticalBox. With these mounting angles, instead of 5 U vertically at the side, up to 10 U may be used horizontally if only a minimal installation depth is required. Infinitely depth-variable positioning.

**Material:**  
Sheet steel, spray-finished

**Colour:**  
RAL 7035

**Supply includes:**  
Assembly parts.

U	Packs of	Model No. QB
12	2	7502.203

**Note:**

10 usable U.

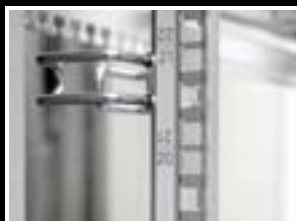

### Adhesive measurement strip, 482.6 mm (19")

Made from robust aluminium foil, guarantees easy handling and durability. With numerical labelling on a 482.6 mm (19") pitch pattern for clear identification of the various height units. The double-sided labelling allows the counting direction to be freely selected, up to a maximum of 56 U. In this way, clear documentation of the various mounting parts is easily achieved.

**Material:**  
Aluminium foil

Labelling range U	Packs of	Model No. DK
1 – 56	1	7950.100

# 482.6 mm (19") installation system

## Mounting angles/Mounting kits for mounting angles

### TS mounting kit, heavy-duty, width-/depth-variable

for mounting frame 482.6 mm (19") in TS, CS basic and modular enclosures

#### Installation in enclosure width 800 mm

The mounting kit allows depth- and width-variable installation of a 600 mm wide mounting frame, 482.6 mm (19"), in 800 mm wide enclosures.

#### Load capacity:

750/1500 kg static load per level/ per enclosure

#### Material:

Sheet steel

#### Surface finish:

Zinc-plated

#### Supply includes:

Assembly parts.

Packs of	Model No. DK
1 set	7827.590



### Additional fastening attachment for mounting angles

for 800 mm wide TS network enclosures

The additional fastening attachment counteracts bending of the mounting angles mounted on installation brackets in case of unevenly distributed loads. It is attached directly to 482.6 mm (19") mounting angles and to the punched section with mounting flange fitted in the depth (inner mounting level).

#### Material:

Sheet steel

#### Supply includes:

Assembly parts.

Packs of	Model No. DK
2	7284.135



#### Also required:

TS punched section with mounting flange for the inner mounting level, see page 459 – 460.



### TS punched section with mounting flange as installation kit

#### For

- Mounting angles, 482.6 mm (19")
- Mounting angles, metric, Mounting dimension 465 mm

#### Installation in enclosure width 600 mm

The installation kit consists of 4 TS punched sections with mounting flange 17 x 73 mm to accommodate mounting angles. One pack is sufficient for installing one or two 482.6 mm (19") attachment levels. For exceptionally heavy installed equipment, we recommend the installation of additional punched sections in the centre.

#### Material:

Sheet steel

#### Surface finish:

Zinc-plated

#### Supply includes:

Assembly parts.

For enclosures		Packs of	Model No. TS
Width mm	Depth mm		
600	600	4	8612.060
600	800	4	8612.080
600	1000	4	8612.000
600	1200	4	8612.020

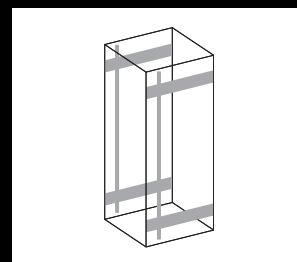
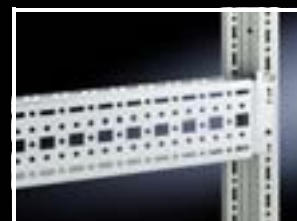

# 482.6 mm (19") installation system

## Mounting kits for mounting angles

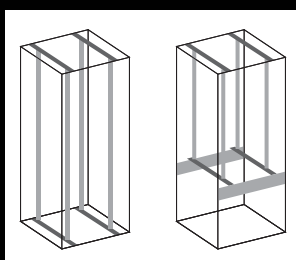

### Depth stays for TS

for mounting angles into TS, 482.6 mm (19")

Installation in enclosure width 800 mm

Depth stays are screw-fastened to the enclosure frame in the enclosure width.

The mounting angle is attached to the depth stay at the top and bottom. The bracket ensures optimum clearance at the sides for cable routing. For partial enclosure configuration, the depth stays may be attached to the TS punched sections with mounting flanges 17 x 73 mm on the outer attachment level of the enclosure frame. Fully depth-variable attachment is facilitated by the attachment slots. Either cranked or L-shaped mounting angles may be used.

**Material:**  
Sheet steel

**Surface finish:**  
Zinc-plated

**Supply includes:**  
Assembly parts.

Installation position	Packs of	Model No. DK
central	2	<b>7827.480</b>
side	2	<b>7827.490</b>

#### + Accessories:

- For partial installation,
- TS punched section with mounting flange, 17 x 73 mm, see page 459 – 460.
  - Mounting angles, cranked or L-shaped, see page 549.

### TS installation kit, width-variable

482.6 mm (19")/metric in TS

Universal depth stays to which both L-shaped and cranked mounting angles may be variably mounted in the depth and width.

Divider kit for all width dimensions

- Imperial mounting dimensions 19"/21"/23"/24"
- Metric mounting dimensions 18/20 SU

**Load capacity:**  
200 kg static load per level

**Material:**  
Sheet steel

**Surface finish:**  
Zinc-plated

**Supply includes:**  
Assembly parts.

For enclosure depth mm	Packs of	Model No. DK
800	1 set	<b>7827.550</b>
1000	1 set	<b>7827.560</b>
1200	1 set	<b>7827.570</b>

1 set = 4 stays

#### + Accessories:

Mounting angles, 482.6 mm (19"), see page 549.

### Depth stays as installation kit for mounting angles, 482.6 mm (19")

Installation in enclosure width 800 mm

One installation kit consists of 4 depth stays to accommodate mounting angles. One pack is sufficient for installing one or two 482.6 mm (19") attachment levels. For exceptionally heavy installed equipment, we recommend the installation of an additional depth stay in the centre. The front cut-out makes cable routing easier with full configuration

**Material:**  
Sheet steel

**Surface finish:**  
Zinc-plated

**Supply includes:**  
Assembly parts.

For enclosures		Packs of	Model No. DK
Width mm	Depth mm		
800	600	4	<b>7827.600</b>
800	800	4	<b>7827.800</b>
800	1000	4	<b>7827.000</b>

#### ⇌ Possible alternative:

Depth stays for TS for mounting angles, see page 556.

# 482.6 mm (19") installation system

## Mounting kits for mounting angles

### Depth stays as installation kit for mounting angles, 482.6 mm (19"), mounting dimensions 23" and 24"

#### Installation in enclosure width 800 mm

When using depth stays in 800 mm wide enclosures, attachment spacings of 23" and 24" are achieved. Either cranked or L-shaped, 482.6 mm (19") mounting angles may be used.

#### Material:

Sheet steel

#### Surface finish:

Zinc-plated

#### Supply includes:

Assembly parts.

#### Mounting dimension 23"

For enclosures		Packs of	Model No. DK
Width mm	Depth mm		
800	800	4	<b>7827.823</b>
800	1000	4	<b>7827.023</b>

Extended delivery times.

#### Mounting dimension 24"

For enclosures		Packs of	Model No. DK
Width mm	Depth mm		
800	800	4	<b>7827.824</b>
800	1000	4	<b>7827.024</b>

Extended delivery times.



#### Accessories:

Mounting angles, cranked or L-shaped, see page 549.



### Mounting frame 54 U

#### for TS

The mounting frame allows configuration of a side-offset 482.6 mm (19") level with 42 U useful installation space plus the additional integration of a further 12 U for vertical installation at the side. The additional side extension is divided into three installation levels arranged on top of one another, each with 4 U.

The mounting frame may be installed at either the front or rear.

#### Material:

Sheet steel

#### Surface finish:

- Mounting bracket: Zinc-plated
- Side trim panel: Spray-finished

#### Colour:

RAL 7035

#### Supply includes:

12 U mounting trim at the side.

For enclosures		Additional vertical installation area	Packs of	Model No. DK
Width mm	Height mm			
800	2000	12 U	1 set	<b>7827.554</b>

Extended delivery times.



#### Also required:

Mounting angles, 482.6 mm (19"), see page 549.



### Mounting kit, 2 U

#### for 482.6 mm (19") equipment

Facilitates fast, simple integration of additional 2 U mounting space within an enclosure by attaching to the enclosure frame or to the existing mounting angles at the sides. The flexible slot fastening of the brackets means that the distance between the two installation brackets may be freely selected, so that other 482.6 mm (19") attachment dimensions may be implemented. The second row of holes is used for the optional configuration of additional mounting surfaces.

#### Material:

Sheet steel

#### Surface finish:

Zinc-plated

#### Supply includes:

Assembly parts.

Packs of	Model No. DK
2	<b>7246.420</b>



# 482.6 mm (19") installation system

## Accessories for Data Rack

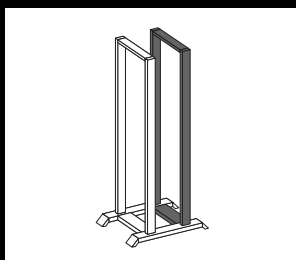

### Second pair of mounting angles

To accommodate 482.6 mm (19") network components or for the attachment of component shelves and slide rails.

482.6 mm (19") punched profile at the front, hole centre distance 465 (470 mm at the rear), tailored to the attachment of patch panels and cable routing rails.

The mounting level may be positioned on a 50 mm pitch pattern.

Minimum distance between levels 150 mm, maximum distance between levels 350 mm.

**Material:**

Sheet steel, 2 mm

**Colour:**

RAL 7035

**Supply includes:**

- 1 torsionally stiff profile frame
- Mounting accessories

U	Packs of	Model No. DK
31	1	<b>7296.000</b>
36	1	<b>7297.000</b>
40	1	<b>7298.000</b>
45	1	<b>7299.000</b>

**Detailed drawing:**

Available on the Internet.

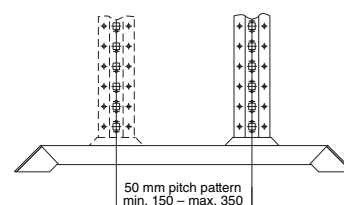

### Baying connector

For assembling rows of distributor frames, or for cable routing between data racks.

**Technical specifications:**

Length: 53 mm

**Colour:**

RAL 7035

Packs of	Model No. DK
3	<b>7494.000</b>



### Roof plate with cable route

For optimised use of the Data Rack as a corridor distributor or cable management rack. The size of individual cable routes may be individually dimensioned by sliding the guide plates. On all Data Racks, the roof plate can be attached with two mounting levels and a distance between the levels of 350 mm.

Packs of	Model No. DK
1	<b>7411.000</b>

**Material:**

Sheet steel, spray-finished

**Colour:**

RAL 7035

**Supply includes:**

- Roof plate
- Mounting accessories



### Depth stays

For securing and stabilising two pairs of 482.6 mm (19") mounting angles in the Data Rack. The length of the depth stays is adjustable, and can accommodate the following spacings of mounting angles: 250, 300 and 350 mm.

Packs of	Model No. DK
2	<b>7401.000</b>

**Material:**

Sheet steel, spray-finished

**Colour:**

RAL 7035



### Continuous slide rail for two pairs of mounting angles, 482.6 mm (19")

To support heavy equipment in the Data Rack. The mounting dimensions of the slide rails were selected to enable them to be combined with 500 mm deep, 482.6 mm (19") component shelves. The mounting distance of the 482.6 mm (19") mounting angles is 350 mm.

**Requirements:**

Second pair of mounting angles

Packs of	Model No. DK
2	<b>7402.000</b>

**Material:**

Sheet steel, zinc-plated



**Accessories:**

Component shelves, 500 mm deep, see page 482.

# 482.6 mm (19") installation system

## Slide rails

### Slide rails, depth-variable, 1 U for TE, 482.6 mm (19") mounting frame, flat mounting angles

The slide rail is pulled out to the required length and secured between the front and rear mounting level. Rear location lugs and front screw-fastening enable convenient one-man assembly. The mounting component to be integrated is inserted horizontally onto the slide rail and optionally secured to the mounting level via its attachment slots.

**Load capacity:**

80 kg/150 kg, static load

**Material:**

Sheet steel

**Surface finish:**

Zinc-plated

**Supply includes:**

Assembly parts.

Length mm	Load capacity kg	Contact surface mm	Packs of	Model No. DK
390 – 600	80	50	2	<b>7063.882</b>
590 – 930	80	50	2	<b>7063.883</b>
590 – 930	150	25	2	<b>7063.884</b>

**Note:**

The super-slimline design of the slide rail allows it to be used in most integration cases for 482.6 mm (19") mounting components. Because it is secured to the standardised mounting level, it is manufacturer-independent.

The slide rail slightly reduces the installation space below the slide rail so that the U below it is only available for limited use.

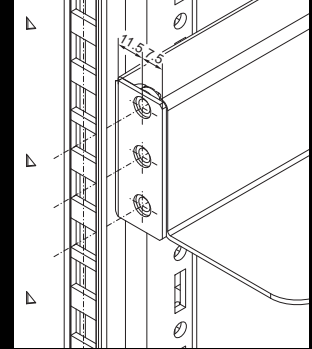

### Slide rails, depth-variable, 1 U for server and network enclosures with two 482.6 mm (19") mounting levels, without additional loss of U

For mounting both on cranked and flat mounting angles, 482.6 mm (19") mounting frames and on TE. The slide rails are pulled out to the required length and secured between the front and rear mounting level on the 482.6 mm (19") pitch pattern.

**Load capacity:**

20 kg static load

**Material:**

Sheet steel

**Surface finish:**

Zinc-plated

**Supply includes:**

Assembly parts.

Distance between 19" levels mm	Contact surface mm	Packs of	Model No. DK
390 – 550	30	2	<b>7063.750</b>
550 – 750	30	2	<b>7063.752</b>

**Note:**

Thanks to the thin support surface of only around 0.8 mm thickness, exceeding the U pitch pattern is generally avoided, provided the components do not exceed a maximum height of 43.5 mm. In this way, several units may be easily arranged on top of one another without offset.

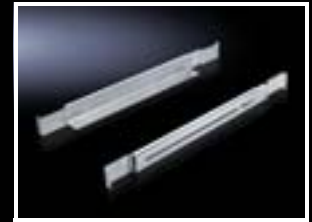

# 482.6 mm (19") installation system

## Slide rails



### Slide rails, heavy-duty

#### for TS network enclosures with two 482.6 mm (19") levels

To support heavy installed equipment. The slide rails are simply located into the cranked mounting angles and secured with screws. The combined use with additional depth stays or, in case of 80 mm wide enclosures, with the additional fastening attachment counteracts possible bending of the mounting angles in case of unevenly distributed loads.

**Load capacity:**  
80 kg, static load

**Material:**  
Sheet steel

**Surface finish:**  
Zinc-plated

**Supply includes:**  
Assembly parts.

**Note:**  
Not suitable for use in 482.6 mm (19") mounting frames.

Distance between 19" levels mm	Contact surface		Packs of	Model No. DK
	Width mm	Depth mm		
–	55	152 <sup>1)</sup>	2	<b>7063.000</b>
298	55	261	2	<b>7492.300</b>
398	55	361	2	<b>7492.400</b>
498	55	461	2	<b>7492.500</b>
598	55	561	2	<b>7492.060</b>
698	55	661	2	<b>7492.070</b>

<sup>1)</sup> Side leg height 72 mm.  
Load capacity: 50 kg, static load.

#### ! Also required:

For fastening to L-shaped TS mounting angles:  
Adaptor DK 7827.300,  
see page 488.



### Slide rails

#### for TE, 482.6 mm (19") mounting frame

For mounting between a front and a rear pair of mounting angles. The slide rails can be used to support heavy 482.6 mm (19") components.

**Load capacity:**  
80 kg, static load

**Material:**  
Sheet steel

**Surface finish:**  
Zinc-plated

**Supply includes:**  
Assembly parts.

Distance between 19" levels mm	Contact surface		Packs of	Model No. DK
	Width mm	Depth mm		
395	85	324	2	<b>7963.310</b>
495	85	424	2	<b>7963.410</b>
595	85	524	2	<b>7963.510</b>
695	85	624	2	<b>7963.610</b>
795	85	724	2	<b>7963.710</b>

#### ⇔ Possible alternative:

Slide rail, depth-variable,  
see page 559.



### Slide rails, heavy-duty

#### for TS, TE

With L-shaped mounting angles or 482.6 mm (19") mounting frame and a clearance between levels of 740 mm.

Easily and quickly installed thanks to locating brackets for the rear level.

**Load capacity:**  
100 kg, static load

**Material:**  
Sheet steel

**Surface finish:**  
Zinc-plated

**Supply includes:**  
Assembly parts.

Distance between 19" levels mm	Contact surface		Packs of	Model No. DK
	Width mm	Depth mm		
740	50	734	2	<b>7063.740</b>

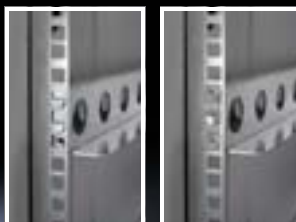



# 482.6 mm (19") installation system

## Slide rails

### Slide rails

#### for TS mounting angles

With **two-sided mounting** between the 482.6 mm (19") front and rear adaptor sections or 482.6 mm (19") adaptor pieces.

#### Material:

Sheet steel

#### Surface finish:

Zinc-plated

#### Supply includes:

Assembly parts.

For enclosure depth mm	Packs of	Model No. TS
500	10	<b>8613.150</b>
600	10	<b>8613.160</b>
800	10	<b>8613.180</b>



#### Also required:

- Adaptor sections, 482.6 mm (19"), see page 551, or
- Adaptor pieces, 482.6 mm (19"), see page 552.



### Slide rails

#### for TS mounting angles

With **one-sided mounting** on the 482.6 mm (19") adaptor sections.

#### Material:

Sheet steel

#### Surface finish:

Zinc-plated

#### Supply includes:

Assembly parts.

Length mm	Packs of	Model No. PS
185	10	<b>4530.000</b>
270	10	<b>4531.000</b>



#### Also required:

- Adaptor sections, 482.6 mm (19"), see page 551.



# 482.6 mm (19") installation system

## 482.6 mm (19") installation

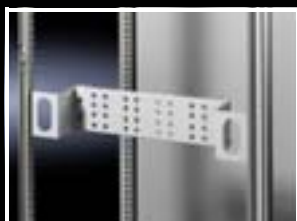

### Adaptor kit, 3 U

#### for 800 mm wide TS enclosures

For fastening individual 482.6 mm (19") components, or as an additional mounting facility at the rear of the enclosure. The mounting level in the adaptor angle can be adjusted in 25 mm increments by up to 100 mm in the depth, leaving sufficient space for buying where patch panels or splicing boxes are used. Attachment is on the inner mounting level of the frame section or a suitable chassis in the enclosure depth.

**Material:**  
Sheet steel

**Colour:**  
RAL 7035

Height	Mounting position	Packs of	Model No. DK
3 U	central	2	<b>7246.100</b>



### Adaptor, 3 U

#### Depth offset 100 mm

This adaptor is used to recess 482.6 mm (19") mounting of equipment inside enclosures with 482.6 mm (19") installation in the foremost position, such as server or electronic enclosures. In this way, sufficient space can be gained in front of the mounting equipment to integrate patch panels or switches, whilst at the same time exploiting the maximum enclosure depth.

**Material:**  
Sheet steel

**Surface finish:**  
Zinc-plated

**Supply includes:**  
Assembly parts.

Packs of	Model No. DK
2	<b>7246.400</b>



### Adaptor, metric to 21"/>"

With this adaptor, 482.6 mm (19") assemblies may be fastened to metric (535 mm) mounting angles, or combined systems may be configured.

**Material:**  
Extruded aluminium section

**Supply includes:**  
Assembly parts.

SU	U	Packs of	Model No. DK
2	1	2	<b>7246.010</b>
6	3	2	<b>7246.030</b>
11	6	2	<b>7246.060</b>

# 482.6 mm (19") installation system

## 482.6 mm (19") installation

### Drawer, 2 U, 3 U

#### for a 482.6 mm (19") mounting level

For front attachment to mounting angles, 482.6 mm (19"). With cover and telescopic slides to accommodate assignment lists, operating manuals and small parts. The small version of the 2 U variant is also suitable for mounting inside a swing frame.

**Material:**  
Sheet steel

**Colour:**  
RAL 7035

**Supply includes:**  
Fully assembled, including assembly parts.

Height	Clearance openings		Installation depth mm	Packs of	Model No. DK
	Width mm	Depth mm			
2 U	411	244	250	1	<b>7282.135</b>
2 U	411	419	427	1	<b>7282.035</b>
3 U	411	419	427	1	<b>7283.035</b>

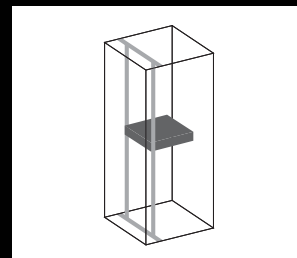

### Drawer for 482.6 mm (19")

#### with adaptor sections

For keyboards, operating manuals etc. The perforated plate in the base helps air to circulate in the enclosure. Load capacity 50 kg. The 1 U drawer can be installed rotated through 180° about its longitudinal axis, allowing it to be used as a utility table.

**Material:**  
– Drawer: Aluminium  
– Telescopic slides: Sheet steel

**Surface finish:**  
– Drawer: Anodised  
– Telescopic slides: Zinc-plated

**Supply includes:**  
Telescopic slides.

U	Packs of	Model No. PS
1	1	<b>4541.000</b>
3	1	<b>4542.000</b>

**!** **Also required:**

Installation kit for enclosure system, see page 563.



### Installation kit

#### for component shelves and drawers, with 482.6 mm (19") installation in TS

For installation between the front and rear adaptor sections or adaptor pieces, 482.6 mm (19") in 600 mm wide enclosures.

**Material:**  
Sheet steel

**Surface finish:**  
Zinc-plated

**Supply includes:**  
Assembly parts.

#### For enclosure system TS

For enclosure depth mm	Packs of	Model No. TS
600	1 set	<b>8800.560</b>
800	1 set	<b>8800.580</b>

**!** **Also required:**

– Adaptor sections, 482.6 mm (19"), see page 551, or  
– Adaptor pieces, 482.6 mm (19"), see page 552.



### Installation kit, depth-variable

#### for 482.6 mm (19") component shelves

Depending on the distance between the two 482.6 mm (19") mounting levels, the installation kit is screw-fastened in the depth between the cranked, L-shaped mounting angles or 482.6 mm (19") mounting frame. Also suitable for TE.

**Material:**  
Sheet steel

**Surface finish:**  
Zinc-plated

**Supply includes:**  
Assembly parts.

Distance between 19" levels mm	Packs of	Model No. DK
550 – 850	2	<b>7063.850</b>



# 482.6 mm (19") installation system

## 482.6 mm (19") installation



### Blanking plate, 482.6 mm (19")

For installation in electronic enclosures or housings.

**Material:**  
Aluminium

**Surface finish:**  
Natural-anodised

U	Packs of	Model No. VC
1	3	<b>1931.200</b>
2	3	<b>1932.200</b>
3	3	<b>1933.200</b>
4	3	<b>1934.200</b>
6	3	<b>1936.200</b>
7	3	<b>1935.200</b>
9	3	<b>1939.200</b>
12	3	<b>1937.200</b>



### Blanking plate, horizontally hinged

For installation in electronic enclosures or housings.

**Material:**  
– Blanking plate: 3 mm aluminium  
– Hinge: Die-cast zinc

**Surface finish:**  
– Blanking plate: Natural-anodised  
– Hinge: Zinc-plated

**Supply includes:**  
Assembly parts.

Width	U	Packs of	Model No. EL
482.6 mm (19")	6	1	<b>1945.000</b>



### Blanking plate, vertically hinged

For installation in electronic enclosures or housings.

**Material:**  
– Blanking plate: 3 mm aluminium  
– Hinge: Die-cast zinc

**Surface finish:**  
– Blanking plate: Natural-anodised  
– Hinge: Zinc-plated

**Supply includes:**  
Assembly parts.

Width	U	Packs of	Model No. EL
482.6 mm (19")	3	1	<b>1940.000</b>
482.6 mm (19")	6	1	<b>1941.000</b>



### Hinge for blanking plates

**Material:**  
Die-cast zinc

**Surface finish:**  
Zinc-plated

**Supply includes:**  
Assembly parts.

Packs of	Model No. EL
2	<b>1950.000</b>



### Ventilated front panels

For venting enclosures and housings.

**Material:**  
Aluminium

**Surface finish:**  
Natural-anodised

Width	U	Packs of	Model No. EL
482.6 mm (19")	1	3	<b>2231.000</b>
482.6 mm (19")	2	3	<b>2232.000</b>
482.6 mm (19")	3	3	<b>2233.000</b>

# 482.6 mm (19") installation system

## 482.6 mm (19") installation

### Air baffle plates

#### for TS

Targeted air routing to the components. To prevent bridges between hot and cold air. Energy efficiency is boosted while retaining cooling output. Mounted all-round on the 482.6 mm (19") installation between the 482.6 mm (19") mounting frame and modular LCP, LCP rack, side panel or partition. The width-variable air baffle plates may be individually adapted to suit the requirements. In the variant for 800 mm wide enclosures, vertical 482.6 mm (19") mounting holes of 3 x 1 U are additionally integrated, which may be used for configuration with additional components. Cable glands with stepped collars distributed across the height facilitate shielded cable routing between the front and rear section. In its delivered state, these openings are sealed with a 1 U blanking panel with snap-in attachment.

For enclosures		Packs of	Model No. DK
Width mm	Height mm		
600	2000	2	<b>7151.206</b>
800	2000	2	<b>7151.208</b>

#### Material:

- Air baffle plates: Sheet steel, spray-finished
- Stepped collar: Plastic, to UL 94-V0
- Blanking panel: Plastic, to UL 94-V0

#### Colour:

RAL 7035

#### Supply includes:

- 2 air baffle plates, side, width-variable
- 1 air baffle plate, top, horizontal
- With 800 mm width including blanking panel and stepped collar

#### Note:

Mounting on the inner and outer mounting level in the enclosure depth is not possible.



### Infill panel, hinged

#### for 800 mm wide TS network enclosures

To cover the side cable chamber. The infill panel is attached to the vertical enclosure frame at the front. The generous curved design will conceal even large quantities of cables, and facilitates combined use with large-scale shunting rings DK 7220.600, see page 534.

The infill panel has a hinged design and allows easy access to the cabling level by simply swinging it out. Locating points keep the panel in its open and closed state.

With an offset 482.6 mm (19") mounting level the panel may likewise be offset in the enclosure depth and secured to TS punched sections with mounting flange on the inner mounting level. For mounting the 482.6 mm (19") attachment level in the foremost mounting position, choose the version with straight trim panel.

#### Material:

Sheet steel

#### Surface finish:

Spray-finished

#### Colour:

RAL 7035

#### Supply includes:

Assembly parts.

#### Trim panel curved

For installation height U	Packs of	Model No. TS
38	2	<b>7827.532<sup>1)</sup></b>
42	2	<b>7827.534</b>
47	2	<b>7827.536</b>

<sup>1)</sup> Extended delivery times.

#### Trim panel straight

For installation height U	Packs of	Model No. TS
42	2	<b>7827.520<sup>1)</sup></b>

<sup>1)</sup> Extended delivery times.



#### Accessories:

- TS punched section with mounting flange 17 x 73 mm for the inner mounting level, see from page 459.
- PS punched section without mounting flange, 23 x 73 mm, see page 464.

#### Note:

The installation of depth stays, e.g. DK 7827.600/.800, is not possible.



# 482.6 mm (19") installation system

## 482.6 mm (19") installation

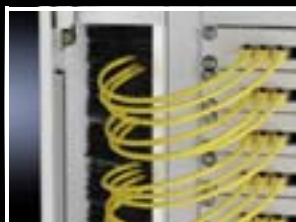
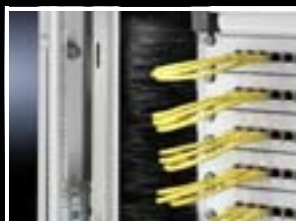

### Brush strip, vertical

#### for TS, TE

Within the network distributor, this serves as a flexible infill panel which stylishly conceals the cable management area to the side of the 482.6 mm (19") mounting level. The brush strip facilitates convenient cable routing from the side and rear distributor area to the front connection level.

The clearance required in front of the mounting level is at least 75 mm.

Within the TS, the brush strip is mounted at the side on the vertical frame section, on horizontal or vertical punched sections. It may also be mounted directly on the mounting level of the TS or TE 7000. For direct mounting on the 482.6 mm (19") mounting frame of the TS or TE, the brush strip should be cut to length accordingly.

#### Material:

Aluminium section with brush strip:  
Plastic, UL 94-V0

#### Supply includes:

1 set = 4 brush strips,  
length 950 mm each.

For enclosure height mm	Packs of	Model No. DK
2000	1 set	<b>7827.544</b>

### Mounting panel 482.6 mm (19"), 2 U

For fast integration of smaller mounting units within the 482.6 mm (19") level, such as potential equalisation rails, distributor boxes, small electrical components etc.

Simple screw-fastening of the components to the integral 25 mm system punchings.

#### Material:

Sheet steel

#### Surface finish:

Zinc-plated

#### Supply includes:

Assembly parts.

Panel height U	Panel width mm	Packs of	Model No. DK
2	450	1	<b>7151.300</b>

### Support

#### for small appliances

For secure attachment of small, non-482.6 mm (19")-conforming equipment such as modems, power packs, routers etc. Angle-shaped support for mounting in the empty space at the side between the 482.6 mm (19") level and the side panel on L-mounting angles, mounting frame or chassis.

Attachment of the components and connection cables can be achieved quickly and easily using nylon tape or cable ties. Also suitable for cable routing in the enclosure depth.

#### Material:

Sheet steel

#### Surface finish:

Zinc-plated

#### Supply includes:

Assembly parts.

W x H x D mm	Packs of	Model No. DK
350 x 150 x 97	1	<b>7246.500</b>

#### Accessories:

Nylon loop, cable ties,  
see page 530.

# 482.6 mm (19") installation system

## 482.6 mm (19") installation

### Mounting kit

#### for VerticalBox

The vertically hinged support plate offers even more flexibility in interior installation for cable routing, attachment of small appliances, socket strips etc.

Depth-variable positioning on a 25 mm pitch pattern.

#### Material:

Sheet steel

#### Surface finish:

Zinc-plated

#### Supply includes:

Assembly parts.

W x H mm	Packs of	Model No. DK
350 x 485	1	7501.100



### Captive nuts M5/M6

For the attachment of rack-mounted electronic equipment, 482.6 mm (19") installed equipment and blanking plates to mounting angles, 482.6 mm (19").

For use with metal thickness from 0.8 – 2.0 mm.

In areas of narrow tolerance, captive nuts for metal thicknesses of 1.2 – 1.5 mm should be used. Optionally with or without contact of the installed equipment to the 482.6 mm (19") section/ enclosure.

#### Captive nut M5

Design	For metal thicknesses mm	Packs of	Model No. EL
With contact	0.8 – 2.0	50	2094.500
Without contact	0.8 – 2.0	50	2092.500

#### Captive nut M6

Design	For metal thicknesses mm	Packs of	Model No. EL
With contact	0.8 – 2.0	50	2094.200
Without contact	0.8 – 2.0	50	2092.200
With contact	1.2 – 1.5	50	2094.300
Without contact	1.2 – 1.5	50	2092.300



### Multi-tooth screws

#### M5 x 16 mm/M6 x 16 mm

For optimum transmission of torques, an extended tool life and increased safety and reliability when tightening and loosening screw connections.

#### Supply includes:

Plastic washers.

	Bit size	Packs of	Model No. DK
M5	Multi-tooth 25	50	7094.130
M6	Multi-tooth 30	50	7094.140



# 482.6 mm (19") installation system

## 482.6 mm (19") installation



### Assembly screws

#### M5 x 16 mm/M6 x 16 mm

For electronic equipment, 482.6 mm (19") installed components and blanking plates.

#### Supply includes:

Plastic washers.

Design	Packs of	Model No. EL
Phillips-head screw M5	50	7094.120
Cheese-head screw M6	50	7094.110
Phillips-head screw M6	50	7094.100



### Cage nut – front mounting, 482.6 mm (19")

The cage nut consists of an expanding nut which is simply inserted into the square attachment hole at the front and then secured with the assembly screw.

When tightening the screw, the cage expands and thus secures the required components. Clamping range from 1.2 – 4.5 mm. Multi-tooth screw head, bit size T 30.

#### Material:

Sheet steel

#### Surface finish:

Zinc-plated

#### Supply includes:

- 50 expanding nuts
- Assembly screws
- Plastic washers

Dimensions mm	Size of mounting hole mm	Packs of	Model No. DK
M6 x 16	9.5 x 9.5	50	2094.400



### Spring nuts with screws

#### M6 x 10 mm for T-slot mounting angle

The spring nuts ensure flexible, secure mounting of accessory components on the T-slot mounting angles.

#### Supply includes:

50 spring nuts,  
50 screws, 10 mm, self-locking.

Design	Packs of	Model No. DK
Phillips-head, M6	50	7000.990



# 482.6 mm (19") installation system

## Patch panels

### Top-hat rail module

Top-hat rail module with mounting clip for top-hat rails to DIN 50 002, robust metal housing, with strain relief.

Cat. 6, 2 x RJ 45, System Corning Future Com S 250 (cables are attached without the use of tools).

Design	Cat.	Packs of	Model No. DK
2 x Corning Future Com S 250	6	3	<b>7870.614</b>



### Data distributors

#### LSA-plus system

24 x RJ 45 jacks, shielded, cover with quick-release fastener, with strain relief, earthing connection and 12 patch cables STP, 0.6 m, yellow.

U	Cat.	Packs of	Model No. DK
1	6	1	<b>7870.830</b>



### For shielded RJ 45 modular jacks

To accommodate shielded RJ 45 jacks. Cut-outs and rear of patch panels electrically conductive to contact the fitted jacks with the patch panel and the zinc-plated 482.6 mm (19") mounting angles.

With accommodation facility for cable clamp straps DK 7610.000 or DK 7611.000.

#### Material:

Sheet steel

#### Surface finish:

Zinc-plated

#### Colour:

- Front: RAL 7035
- Reverse: Zinc-plated, passivated

U	Number of locations	Packs of	Model No. DK
1	16	1	<b>7394.035</b>



#### Accessories:

Cable clamp strap DK 7610.000 or DK 7611.000, see page 535.

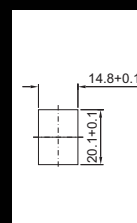

### For 24 V interfaces

For the installation of 16 sub-D (trapezoid) jacks and connectors.

With accommodation facility for cable clamp straps DK 7610.000 or DK 7611.000.

L1 mm	L2 mm	L3 mm	Packs of
25	21	16.5	1
33.3	29.2	24.7	1
47	43	38.5	1

U	For no. of poles	Number of locations	Model No. DK
2	9	16	<b>7087.535</b>
2	15	16	<b>7086.535</b>
2	25	16	<b>7089.535</b>

#### Material:

Sheet steel

#### Colour:

RAL 7035



#### Accessories:

Cable clamp strap DK 7610.000 or DK 7611.000, see page 535.

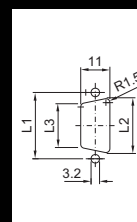

### To accommodate BNC jacks (version E)

With accommodation facility for cable clamp straps DK 7610.000 or DK 7611.000.

#### Material:

Sheet steel

#### Colour:

RAL 7035

U	Number of locations	Packs of	Model No. DK
3	32	1	<b>7069.535</b>



#### Accessories:

Cable clamp strap DK 7610.000 or DK 7611.000, see page 535.

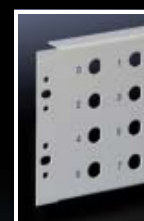
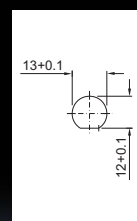

# 482.6 mm (19") installation system

## Patch panels

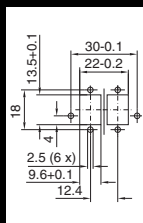

### To accommodate E-2000, E-2000 duplex, SC or LC duplex fibre-optic couplings

For 1 U with accommodation facility for cable clamp straps DK 7610.000 or DK 7611.000.

**Material:**  
Sheet steel

**Colour:**  
RAL 7035

U	Number of locations single/duplex	Packs of	Model No. DK
1	16/8	1	7433.035

Extended delivery times.

#### Accessories:

Cable clamp strap DK 7610.000 or DK 7611.000, see page 535.

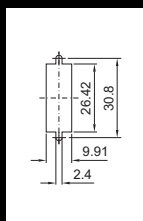

### To accommodate SC duplex and LC quad fibre-optic couplings

With accommodation facility for cable clamp straps DK 7610.000 or DK 7611.000.

**Material:**  
Sheet steel

**Colour:**  
RAL 7035

U	Number of locations	Packs of	Model No. DK
1	12	1	7154.035

#### Accessories:

Cable clamp strap DK 7610.000 or DK 7611.000, see page 535.

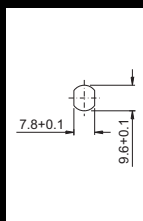

### To accommodate ST fibre-optic couplings

With accommodation facility for cable clamp straps DK 7610.000 or DK 7611.000.

**Material:**  
Sheet steel

**Colour:**  
RAL 7035

U	Number of locations	Packs of	Model No. DK
1	16	1	7437.035

Extended delivery times

#### Accessories:

Cable clamp strap DK 7610.000 or DK 7611.000, see page 535.



### Panel 1 U, 482.6 mm (19")

#### with solid tray

For the storage of fibre-optic coupling covers or assembly parts.  
Depth: 100 mm

**Material:**  
Sheet steel

**Colour:**  
RAL 7035

U	Packs of	Model No. DK
1	1	7300.335

# 482.6 mm (19") installation system

## Patch panels

### Blanking panel, 482.6 mm (19")

As an extension cover or for population as required.

**Material:**  
Sheet steel

#### Colour: RAL 7035

U	Installation height mm	Packs of	Model No. DK
1	44	2	7151.035
1.5	66	2	7157.035
2	88	2	7152.035
3	132.5	2	7153.035
6	266	2	7156.035

#### Colour: RAL 9005

U	Installation height mm	Packs of	Model No. DK
1	44	2	7151.005
2	88	2	7152.005
3	132.5	2	7153.005 <sup>1)</sup>
6	266	2	7156.005 <sup>1)</sup>

<sup>1)</sup> Extended delivery times.



### Blanking panel, 482.6 mm (1 U)

#### Toolless attachment, 482.6 mm (19")

The blanking panel is used to seal unused areas within the 482.6 mm (19") mounting level. Quick toolless attachment means that it is easily integrated anywhere, and can also be removed again if necessary. The consistent use of blanking panels ensures targeted air routing in partially configured racks.

**Material:**  
Plastic, ABS

**Fire protection:**  
Self-extinguishing to UL 94-V0, non-halogen-free

**Supply includes:**  
10 blanking panels with integral quick-fastening.

Colour	Packs of	Model No. DK
RAL 7035	10	7151.110
RAL 9005	10	7151.105



### Identification strips

#### for patch panels

For individual labelling of different slots, self-adhesive.

Length: 210 mm, height: 10 mm.

Packs of	Model No. DK
32	7167.000



# 482.6 mm (19") installation system

## Splicing boxes



### Splicing cassette holder

To accommodate differently sized splicing cassettes with variable cassette accommodation. Up to 8 splicing cassettes may be fitted in one holder. The splicing cassette holder can be flexibly secured to any mounting surface, and is particularly suitable for retro-fitting in small fibre-optic distributors without patch panels.

**Material:**  
Sheet steel

**Colour:**  
RAL 7035

- Supply includes:**
- Holder with threaded bolts
  - Variable bracket
  - Cassette cover
  - Knurled nut
  - Assembly parts

Height		Packs of	Model No. DK
Overall height mm	Threaded bolts mm		
93	85	1	7450.035



### Fibre-optic splicing box, depth-variable

The 482.6 mm (19") splicing box is designed to accommodate splicing cassettes and can be installed in any network distributor with 482.6 mm (19") accommodation and used as a fibre-optic termination or distributor. The variable cassette fixture permits twist-proof installation of all standard splicing cassettes. The rear section of the splicing box is completely open for cable entry; a rubber cable clamp strip provides protection against dust. The fibre-optic cables can be secured with cable ties or cable clamps.

The splicing box is infinitely depth-adjustable up to 100 mm within the 482.6 mm (19") flanges. In addition, the splicing box may be fully withdrawn from the 482.6 mm (19") flanges. Two strain relief clips and cable routing clips for the fibre stock provide a solution to suit any fibre-optic wiring system.

U	Maximum no. of splicing cassettes	Packs of	Model No. DK
1	2	1	7241.005
2	4	1	7242.005

**Installation depth:**  
302 mm

**Material:**  
Sheet steel

**Colour:**  
RAL 7035

- Supply includes:**
- Splicing box
  - Cable routing clips
  - Cassette cover
  - Mounting accessories for patch panel

**Note:**  
Supplied without patch panel and splicing cassettes.



### Fibre-optic breakout box, 1 U

For splice-free cabling of fibre-optic breakout cables.

Cable bundles may be clamped on the hammer heads at the rear. 4 self-adhesive cable clips are supplied loose for cable clamping and for storing excess lengths inside the box.

**Material:**  
Sheet steel

**Colour:**  
RAL 7035

- Supply includes:**
- Breakout box
  - Cable routing clips
  - Mounting accessories for patch panel

Installation depth	Packs of	Model No. DK
250 mm	1	7241.500

# 482.6 mm (19") installation system

## Splicing boxes

### Patch panels

#### For

- Fibre-optic splicing box, depth-variable
- Fibre-optic breakout box, 1 U

With cut-outs for population with fibre-optic couplings.

#### Material:

Sheet steel

#### Colour:

RAL 7035

#### Note:

For drawings of the cut-outs, see page 569/570.

For coupling	Number of locations	U	Packs of	Model No. DK
ST	12	1	1	7241.015
	16	1	1	7241.065
	24	2	1	7242.015
E-2000, E-2000 duplex <sup>1)</sup> , SC or LC duplex	24	1	1	7241.024
SC duplex, LC quad	12	1	1	7241.045

<sup>1)</sup> For E-2000 duplex only half of the locations are available.



### Fibre-optic splicing box with telescopic pull-out

#### lockable

The 482.6 mm (19") splicing box is designed to accommodate splicing cassettes and can be installed in any network distributor with 482.6 mm (19") accommodation and used as a fibre-optic termination or distributor. The telescopic pull-out provides optimum access to the splicing cassettes and cable clamp. The variable cassette fixture permits twist-proof installation of all standard splicing cassettes. The security lock fitted at the front protects against unauthorised access. The rear section of the splicing box is completely open for cable entry; a rubber cable clamp strip provides protection against dust. The fibre-optic cables can be secured with cable ties or cable clamps; two strain relief clips and cable routing clips for the fibre stock provide a solution to suit any fibre-optic wiring system.

U	Maximum no. of splicing cassettes	Packs of	Model No. DK
1	2	1	7170.535
2	4	1	7470.535
3	6	1	7570.535

#### Installation depth:

363 mm

#### Material:

Sheet steel

#### Colour:

RAL 7035

#### Supply includes:

- Splicing box
- Cable routing clips
- Security lock
- Cassette cover
- Mounting accessories for patch panel

#### Note:

Supplied without patch panel and splicing cassettes.



### Patch panels

#### for fibre-optic splicing box, lockable

There is a choice of 20 panels with appropriate cutouts for the installation of various fibre-optic couplings, together with 3 blanking panels for individual population or as a cover.

#### Material:

Sheet steel

#### Colour:

RAL 7035

#### Note:

For drawings of the cut-outs, see page 569/570.

For coupling	Number of locations	U	Packs of	Model No. DK
ST	12	1	1	7174.535 <sup>1)</sup>
	24	2	1	7474.535
	48	3	1	7574.535 <sup>1)</sup>
E-2000, E-2000 duplex <sup>2)</sup> or SC, LC duplex	20	1	1	7178.535
		2	1	7478.535
		3	1	7578.535 <sup>1)</sup>
SC duplex, LC quad	12	1	1	7169.535
	24	2	1	7469.535

<sup>1)</sup> Extended delivery times.

<sup>2)</sup> For E-2000 duplex only half of the locations are available.



# 482.6 mm (19") installation system

## Splicing boxes/LSA connection system



### Blanking cover

#### for fibre-optic cut-outs

To cover unused cut-outs in patch panels.

#### Material:

Plastic PA 6.6

#### Colour:

Black

	Packs of	Model No. DK
SC, E-2000, LC duplex	20	7300.230
E-2000 duplex	20	
SC duplex, LC quad	20	7300.240
ST	20	7300.250



### Fixture with rods, 3 U

#### for LSA strips

To accommodate 15 LSA profile dividing strips 2/10 on 2 rods, Ø 12 mm.

The fixture unit may be integrated in all 482.6 mm (19") mounting levels. With cable clamp rail at the rear.

#### Dimensions:

W x H x D:

482.6 mm (19") x 132.5 mm (3 U) x 180 mm

U	Packs of	Model No. DK
3	1	7050.200

#### Material:

- Side panels: Aluminium plates
- 482.6 mm (19") flange/horizontal rail: Extruded aluminium section

#### Supply includes:

Fixture with rods as modular system.



### Support unit, 3 U

#### for LSA-Plus strips, max. 150 paired wires

To accommodate a maximum of 15 LSA-Plus strips (each with 10 paired wires). 3 x 5 LSA-Plus connection strips 2/10, series 2, may be installed horizontally. Strip length 124 mm, height pitch pattern 22.5 mm. The support unit may be integrated in all 482.6 mm (19") mounting levels. The mounting level is recessed 75 mm behind the 482.6 mm (19") flanges. Integral shunting rings enable tidy routing and distribution of the telecommunication cables.

U	Packs of	Model No. DK
3	1	7050.100

#### Material:

Stainless steel

#### Supply includes:

Support unit, 8 shunting rings.



### Accommodation system, 2 U

#### for LSA installation kit

To accommodate LSA mounting troughs/cable retainers on the 482.6 mm (19") mounting angle.

#### Dimensions:

- Overall depth: 98.5 mm
- Height: 2 U

#### Material:

Sheet steel

#### Colour:

RAL 7035

U	Packs of	Model No. DK
2	2	7050.035



#### Accessories:

FM universal mounting bracket, see page 575.



# 482.6 mm (19") installation system

## LSA connection system

### FM universal mounting bracket

The universal mounting bracket for LSA-Plus strips (8 or 10 paired wires) and other connection systems are comprised of 2 brackets, which may be combined with different systems depending on their position in relation to one another. The brackets also slide flexibly against each other so that strips with different lengths can be used.

**Material:**

Sheet steel

**Surface finish:**

Zinc-plated

**Supply includes:**

- 2 mounting brackets
- Support strips
- Assembly parts

Length mm	Connection system	LSA-Plus	Other connection systems	Packs of	Model No. DK
	Pitch pattern in mm	22.5	17.5		
275	No. of strips	12	15	1 set	<b>7031.100</b>







# System accessories for monitoring

## CMC III Processing Unit/Compact

CMC III system representation .....	578
CMC III system overview .....	580
CMC III Processing Unit/Compact .....	582

## CMC III sensors/accessories

Control units for CMC III Processing Unit .....	583
CMC III sensors for direct connection .....	583
Interface for CMC II sensors .....	583
Access System .....	583
Interface for PSM, PCU, FCS, DRC .....	583

## CMC III accessories

Power pack .....	584
Programming cable .....	584
CAN-Bus connection cable .....	584
Connection cable/extension .....	585
Extension cable .....	585
CMC III mounting unit, 1 U .....	585
CMC III mounting unit .....	585
Mounting unit, 1 U .....	586
Display Unit II .....	586
ISDN unit .....	586
GSM unit, quad-band .....	587
Fan Control System FCS .....	587
Fan 24 V DC for FCS .....	587
Universal lock unit .....	587

## Door Control System

Door Control System .....	588
Door control module .....	589
Door kit .....	589
Door comfort handle .....	589
Door switch .....	589

## Monitor/keyboard unit

Monitor/keyboard unit .....	590
-----------------------------	-----

## KVM switches

SSC view 8 USB .....	591
SSC view 32 Cat .....	591
SSC compact 32 Cat .....	591
SSC premium 2/16, 4/32, 8/32 .....	592
SSC Duo 16 .....	593
Console local .....	594
Console Cat 5 .....	594
Console IP .....	595
SSC cnverter .....	595
SSC converter VT100 (RS232) .....	595
CPU cable .....	596
Cat 5 patch cable .....	596
SSC Power Control .....	596
SSC Power Pack .....	596

## Dynamic Rack Control

RFID mounting frame .....	597
RFID tags .....	597
RFID controller .....	597



# Monitoring system CMC III

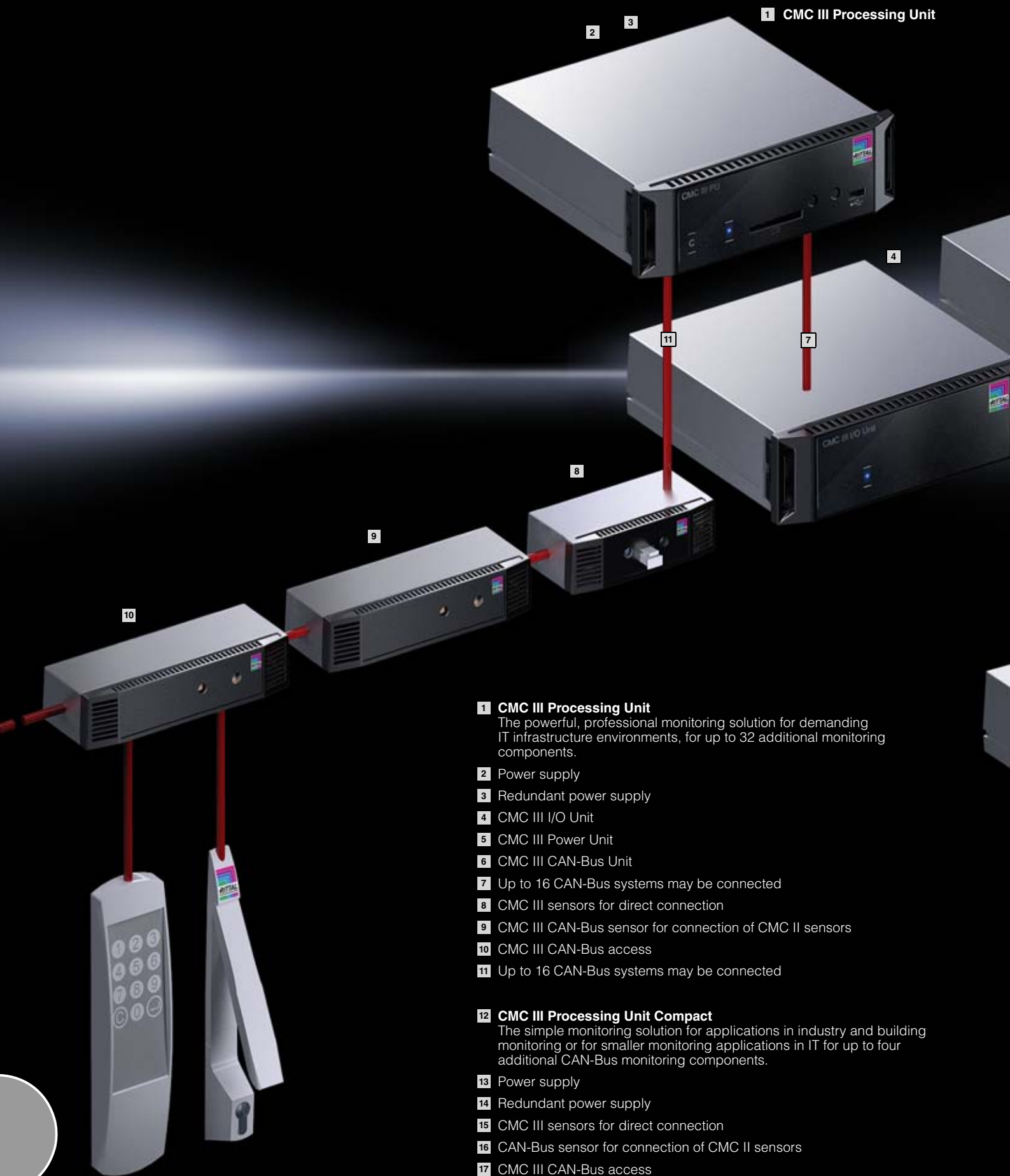

**1** CMC III Processing Unit

**1** CMC III Processing Unit

The powerful, professional monitoring solution for demanding IT infrastructure environments, for up to 32 additional monitoring components.

**2** Power supply

**3** Redundant power supply

**4** CMC III I/O Unit

**5** CMC III Power Unit

**6** CMC III CAN-Bus Unit

**7** Up to 16 CAN-Bus systems may be connected

**8** CMC III sensors for direct connection

**9** CMC III CAN-Bus sensor for connection of CMC II sensors

**10** CMC III CAN-Bus access

**11** Up to 16 CAN-Bus systems may be connected

**12** CMC III Processing Unit Compact

The simple monitoring solution for applications in industry and building monitoring or for smaller monitoring applications in IT for up to four additional CAN-Bus monitoring components.

**13** Power supply

**14** Redundant power supply

**15** CMC III sensors for direct connection

**16** CAN-Bus sensor for connection of CMC II sensors

**17** CMC III CAN-Bus access

**18** Up to four CAN-Bus systems may be connected

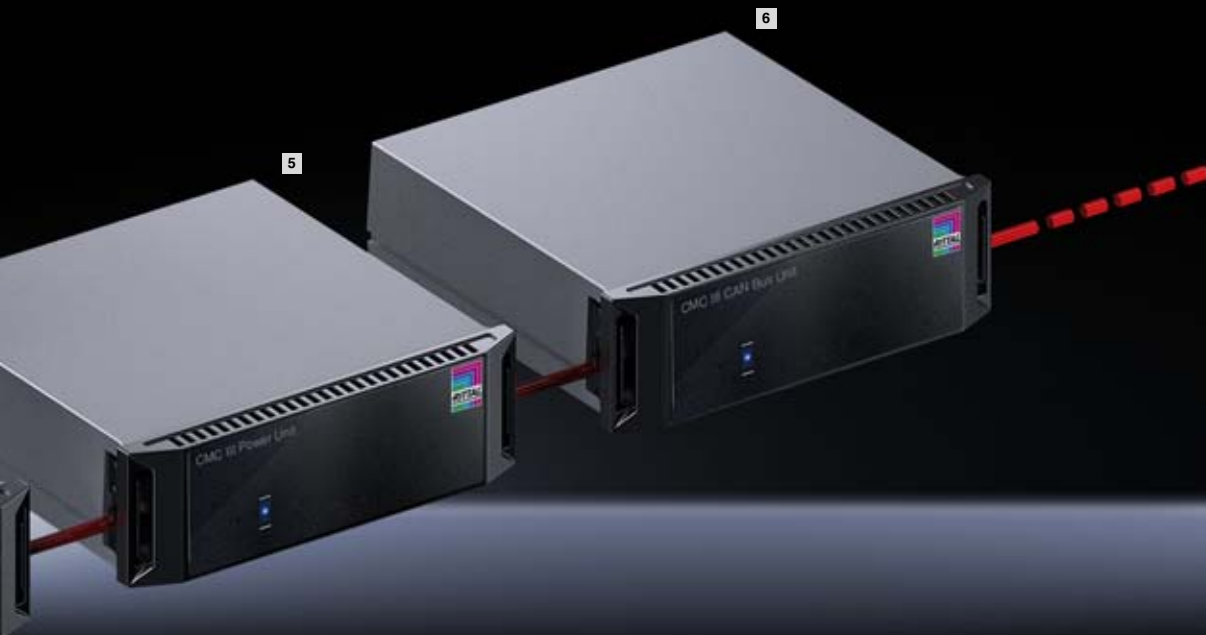

12 CMC III Processing Unit Compact



# CMC III Processing Unit Compact

## System overview



Up to 4 CAN-Bus components are supported.<sup>1)</sup>

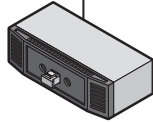

**CMC III sensors**  
for direct connection

**CMC III CAN-Bus sensor**

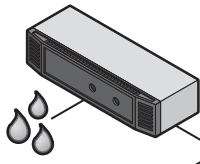

**CMC II sensors**

**CMC III CAN-Bus access**

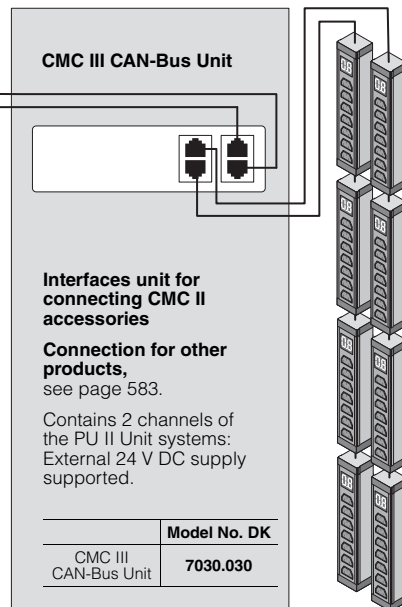
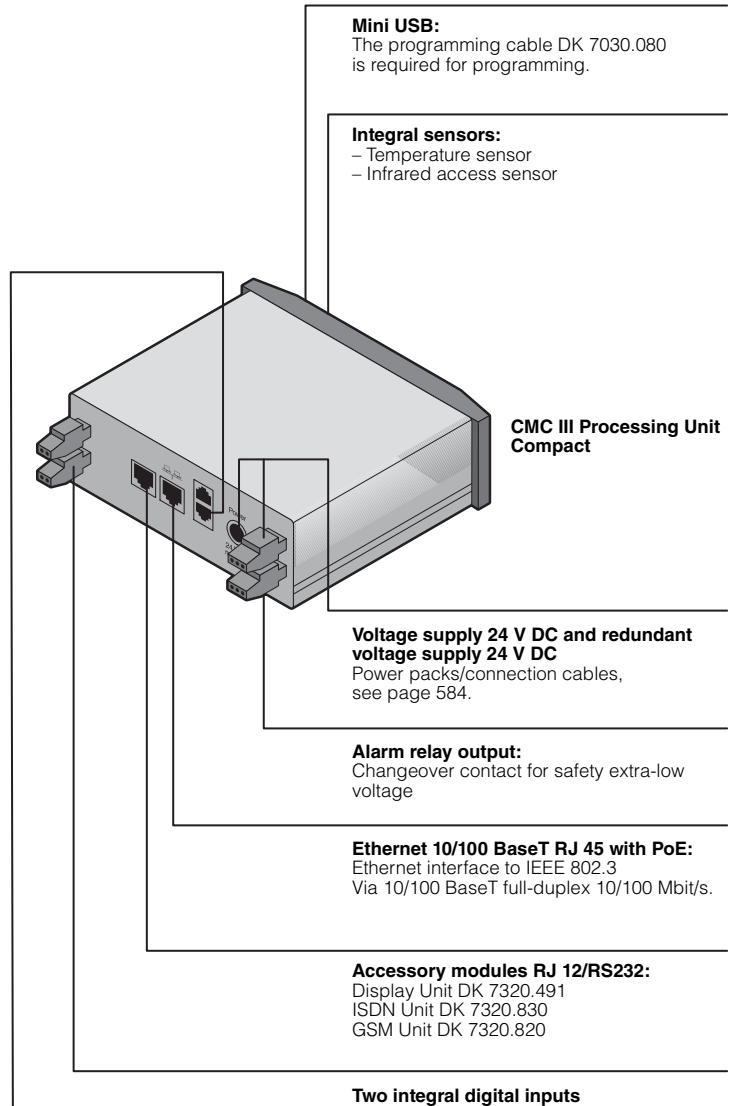
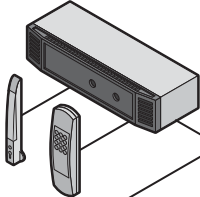

<sup>1)</sup> Depending on the power supply/connection combinations, see page 583.

# CMC III Processing Unit

## System overview

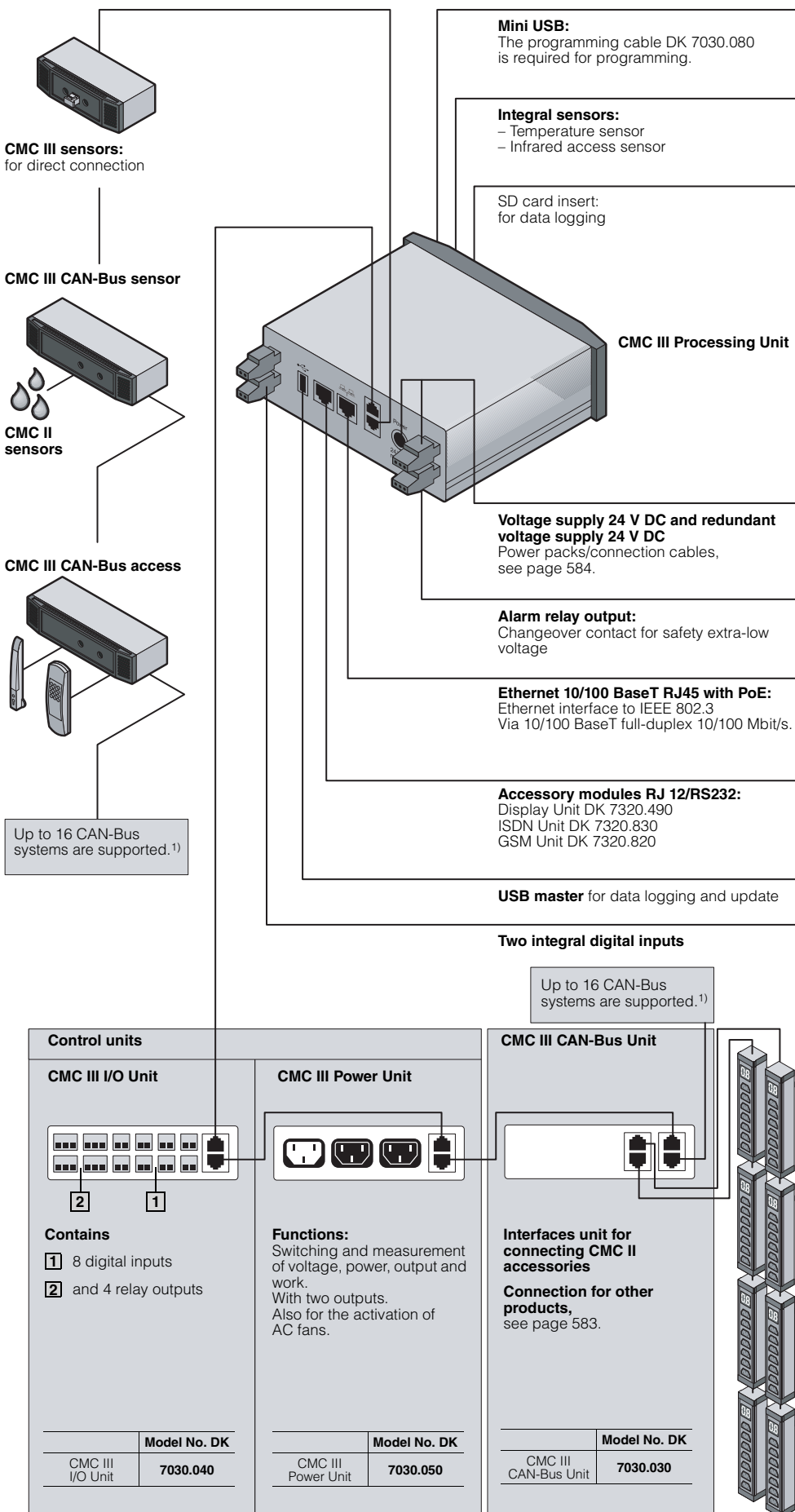

<sup>1)</sup> Depending on the power supply/connection combinations, see page 583.

# CMC III Processing Unit/Compact



System overview Page 580/581 Basic modules and connection accessories Page 583

## Application areas:

### CMC III Processing Unit Compact:

- Industrial and enclosure monitoring
- Building monitoring
- Small monitoring applications in IT

### CMC III Processing Unit

- Larger monitoring applications in IT and industry

## Material:

Plastic

## Surface finish:

- Front: Smooth
- Enclosure: Textured

## Colour:

- Front: RAL 9005
- Enclosure: RAL 7035

## Protection category:

IP 30 to IEC 60 529

## Supply includes:

- Basic system
- Quick-start instructions
- 4 mounting feet

Photo shows a configuration example with equipment not included in the scope of supply.

		CMC III Processing Unit Compact	CMC III Processing Unit
W x H x D mm		138 x 40 (1 U) x 120 + 12 (front assembly)	138 x 40 (1 U) x 120 + 12 (front assembly)
Temperature range		0°C to +55°C	0°C to +55°C
Operating humidity range		5% to 95% relative humidity, non-condensing	5% to 95% relative humidity, non-condensing
Sensors/CAN-Bus connection units		max. 4	max. 32
Max. overall cable length for CAN-Bus		1 x 50 m	2 x 50 m
<b>Model No. DK</b>		<b>7030.010</b>	<b>7030.000</b>
<b>Interfaces</b>	Network interface (RJ 45)	Ethernet to IEEE 802.3 via 10/100BaseT with PoE	Ethernet to IEEE 802.3 via 10/100BaseT with PoE
	Front USB interface	Mini USB for system setting	Mini USB for system setting
	Rear USB interface	–	for USB stick for data recording and SW updates up to 32 GB
	Front SD-HC slot	–	1 x up to 32 GB for data recording
	Rear serial RS232 (RJ 12)	1 x for connecting Display Unit DK 7320.491 or GSM Unit DK 7320.820 or ISDN Unit DK 7320.830	1 x for connecting Display Unit DK 7320.491 or GSM Unit DK 7320.820 or ISDN Unit DK 7320.830
<b>Inputs and outputs</b>	Digital inputs (terminal)	2	2
	Relay output (terminal)	Changeover contact max. 24 V DC, 1 A	Changeover contact max. 24 V DC, 1 A
	CAN-Bus (RJ 45)	1 x for max. 4 sensors (quantity restriction, see page 583)	2 x for max. 16 sensors each = 32 sensors in total (quantity restriction, see page 583)
<b>Operation/ signals</b>	Push-button	1 x acknowledgement button	1 x acknowledgement button
	Concealed reset button	1 x service button	1 x service button
	Piezo signal generator	1	1
	LED display	1 x multi-colour OK/warning/alarm	1 x multi-colour OK/warning/alarm
	Rear LED	1 x for the network status	1 x for the network status
<b>Protocols</b>	Ethernet	TCP/IPv4, TCP/IPv6, SNMPv1, SNMPv3, Telnet, SSH, FTP, SFTP, HTTP, HTTPS, NTP, DHCP, DNS server, SMTP, XML, Syslog, LDAP	TCP/IPv4, TCP/IPv6, SNMPv1, SNMPv3, Telnet, SSH, FTP, SFTP, HTTP, HTTPS, NTP, DHCP, DNS server, SMTP, XML, Syslog, LDAP
	<b>Redundant power supply</b>	Input 24 V DC (jack)	1 x for connecting CMC III power pack
	Input 24 V DC (terminals)	1 x for direct connection or for connecting CMC III power pack	1 x for direct connection or for connecting CMC III power pack
	Power over Ethernet	1 x	1 x
<b>Functions</b>	Time function	Real-time clock, energy-buffered (24 h) without battery/accumulator, with NTP	Real-time clock, energy-buffered (24 h) without battery/accumulator, with NTP
	User administration	LDAP	LDAP
	User interface	Integral WEB server	Integral WEB server
	Control room connection	Integral OPC server	Integral OPC server
<b>Integral sensors</b>	Temperature sensor	NTC sensor in the enclosure front	NTC sensor in the enclosure front
	Access sensor	Infrared technology in the enclosure front	Infrared technology in the enclosure front

# CMC III sensors/accessories

## Control units for CMC III Processing Unit

	Model No. DK	PU Compact	PU	Page
		Maximum quantity		
CMC III I/O Unit, 8 digital inputs + 4 relay outputs	7030.040 <sup>3)</sup>	–	16	581
CMC III Power Unit, 1 input (C14) + 2 outputs (C13) 230 V, 50/60 Hz	7030.050 <sup>3)</sup>	–	16	581

## CMC III sensors for direct connection

Temperature sensor	7030.110	4	32	–
Temperature/humidity sensor	7030.111	4	32	–
Infrared access sensor	7030.120	4	32	–
Vandalism sensor	7030.130	4	32	–
Analog airflow sensor	7030.140	4	10 <sup>1)</sup>	–
Analog differential pressure sensor	7030.150	4	32	–
Universal sensor (digital input or 4-20 mA or S <sub>0</sub> Bus power meter or Wiegand interface)	7030.190	4	32	–

## Interface for CMC II sensors

CMC III CAN-Bus sensor	7030.100	4	32	–
For connecting the following products:				
5 x access sensors (packs of 2), connect a max. of 5 in series	7320.530			–
1 x smoke detector	7320.560			–
1 x motion detector	7320.570			–
1 x voltage monitor 48 V DC	7320.620			–
1 x leakage sensor	7320.630			–
1 x leakage sensor, with sensor length 15 m	7320.631			–
1/3 x fire detector and extinguisher system DET-AC Plus with 3 messages	7338.120			328
1/3 x early fire detection system DET-AC Plus with 3 messages	7338.220			328
1/2 x door control system with 2 enclosure channels	7320.790			589

## Access System

CMC III CAN-Bus Access (with integral infrared access sensor and interface for one reader III)	7030.200	2	16 <sup>1)</sup>	–
For connecting the following products:				
1 x Ergoform-S handle (electro-magnetic)	7320.700			–
1 x Comfort handle TS 8 (electro-magnetic TS 8 handle with master key function, with and without CCP)	7320.721			–
1 x universal lock	7320.730			587
1 x universal handle	7320.950			–
1 x CMC III coded lock	7030.220	2	16 <sup>1)</sup>	–
1 x CMC III transponder reader	7030.230	2	16 <sup>1)</sup>	–

## Interface for PSM, PCU, FCS, DRC

CMC III CAN-Bus Unit for 2 unit channels	7030.030 <sup>3)</sup>	1	4 <sup>2)</sup>	581
For connecting the following products (note: separate supply via power pack possible):				
2 x Fan Control System FCS (DK 7320.812 fan 24 V DC for FCS)	7320.810			587
2 x fan mounting plate DC (universal fan roof W x D 800 x 800 mm with FCS)	7858.488			224
2 x RFID controller DRC	7890.500			597
2 x 4 x Rittal Power Control Unit (PCU) 8-way	7200.001			510
2 x 4 x Rittal Power Control Unit (PCU) C13/earthing pin LED 6-way	7859.215			510
2 x 4 x Rittal Power Control Unit (PCU) C13 LED 8-way	7859.225			510
2 x 4 x Rittal Power Control Unit (PCU) C13/19 LED 6-way	7859.235			510
2 x 4 x PSM socket module active PSM C13 8-way	7856.201			203
2 x 4 x PSM socket module active PSM C13/earthing pin 6-way	7856.203			510
2 x 4 x PSM socket module active PSM C13/19 6-way	7856.204			510
2 x 4 x PSM socket module active PSM C13/earthing pin LED 6-way	7859.212			203
2 x 4 x PSM socket module active PSM C13 LED 8-way	7859.222			203
2 x 4 x PSM socket module active PSM C13/19 LED 6-way	7859.232			203
2 x PSM busbar with measurement 16 A	7856.016			202
2 x PSM busbar with measurement 32 A	7856.003			202
2 x PSM measurement module 16 A	7856.019			204

<sup>1)</sup> Max. 5 p. and <sup>2)</sup> max. 1 p. for power supply with PoE or 48 V power pack.

<sup>3)</sup> Optional attachment see page 585.



# CMC III accessories



## Power pack 230 V

The CMC III power pack may be integrated into the CMC III assembly unit

CMC III power pack	Model No. DK
CMC III power pack Input voltage 100 – 240 V 50/60 Hz, output voltage 24 V DC, 2 A	<b>7030.060<sup>1)</sup></b>

<sup>1)</sup> Connection cable/extension required  
D/F/B: 230 V, Model No. DK 7200.210  
USA/CDN: 230/115 V, Model No. DK 7200.214  
C13/C14: 230/115 V, Model No. DK 7200.215



## Power pack 48 V/ Connection cable 24 V

### for CMC III PU, PU Compact/FCS

An alternative power pack is designed for the telecommunications sector (48 V battery voltages) and is connected at the input end via a terminal block.

The power pack includes an output cable, 1.65 m long.

#### Technical specifications DK 7320.435:

- Rated voltage: 20 – 72 V DC
- Rated current: max. 2.5 A
- Secondary range: 24 V DC, 1.3 A

Primary input voltage	Output voltage	Model No. DK
48 V DC	24 V DC	<b>7320.435</b>

**Connection cable for CMC III/FCS for direct connection, provided the 24 V DC supply is available.**

Packs of	Length	Model No. DK
1	2 m	<b>7320.813</b>



## Programming cable

The programming cable is required for commissioning of the Processing Unit (PU) or PU Compact.

	Model No. DK
CMC III programming cable USB	<b>7030.080</b>



## CAN-Bus connection cable

This can be used to connect the PU with the CAN-Bus sensors III, units III, control units III as a bus. Also for cabling together.

Cable	Length (m)	Packs of	Model No. DK
CMC III CAN-Bus connection cable RJ 45	0.5	1	<b>7030.090</b>
CMC III CAN-Bus connection cable RJ 45	1	1	<b>7030.091</b>
CMC III CAN-Bus connection cable RJ 45	1.5	1	<b>7030.092</b>
CMC III CAN-Bus connection cable RJ 45	2	1	<b>7030.093</b>
CMC III CAN-Bus connection cable RJ 45	5	1	<b>7030.094</b>
CMC III CAN-Bus connection cable RJ 45	10	1	<b>7030.095</b>



# CMC III accessories

## Connection cable/extension

The cable is used to connect to:

- CMC III power pack C13
- CMC III power unit C13
- PCU

### Technical specifications:

PVC cable, 3-pole, with IEC connector (non-heating appliances) with contact protection CEE22.  
Length: at least 1.8 m

Country version	Voltage Volt	Model No. DK
D/F/B/C13	230	<b>7200.210</b>
USA/CDN/C13	230/115	<b>7200.214</b>
IEC 320 device extension C13/C14	230/115	<b>7200.215</b>
Connection cable D/C19	230/115	<b>7200.216</b>
Connection cable C19/C20	230/115	<b>7200.217</b>



## Extension cable

for cable extension of CMC III sensors and FCS fans

Connector/jack	Length m	Packs of	Model No. DK
RJ 12	5	4	<b>7200.450</b>
RJ 12	1	2	<b>7320.814</b>



## CMC III mounting unit, 1 U

To accommodate PU, PU Compact, control units, CMC III CAN-Bus unit and CMC III power pack. The mounting unit can accommodate up to 3 units and is secured in the 482.6 mm (19") frame.

	Packs of	Model No. DK
CMC III mounting unit, 1 U	1	<b>7030.070</b>

### + Accessories:

Cable clamp strap DK 7610.000, see page 535.



## CMC III mounting unit

for enclosure frame

Can accommodate one unit and is mounted on the enclosure frame.

	Packs of	Model No. DK
CMC III mounting unit for enclosure frame	1	<b>7030.071</b>



# CMC III accessories



## Mounting unit, 1 U

**For display, ISDN and GSM unit, fan control system, door control module, dynamic rack control**

For accommodating between two 482.6 mm (19") mounting angles. Cable clamp straps DK 7610.000 or DK 7611.000 can be used for cable clamping.

**Material:**  
Sheet steel

**Surface finish:**  
Spray-finished

**Colour:**  
RAL 7035

### Mounting unit, 1 U

Packs of	Model No. DK
1	7320.440

### Single cover

Packs of	Model No. DK
2	7320.441

### + Accessories:

Cable clamp strap, see page 535.

## Display Unit II

The Display Unit II may be linked directly to the CMC III. CMC alarms, status messages, temperatures, voltages, currents etc. may be displayed on the screen, depending on the monitoring application.

Packs of	Model No. DK
1	7320.491

### Note:

The serial interface RS232 of the PU/PUC may only be assigned to one accessory module.

### ! Also required:

- Processing unit, see page 582.
- Mounting unit, see page 586.

## ISDN unit

For configuring a redundant transmission channel or, if there is no network infrastructure available, for alarm forwarding. The alarm signal is designed in SMS format. Power supply is via the processing unit.

### Requirements for the ISDN connection:

- DSS1 (Euro-ISDN) must also be provided when connecting to the ISDN system
- Point-to-multi-point configuration

**Supply includes:**  
Connection cable.

Components	Model No. DK
ISDN unit	7320.830 <sup>1)</sup>

<sup>1)</sup> Extended delivery times.

### Note:

The serial interface RS232 of the PU/PUC may only be assigned to one accessory module.

### ! Also required:

- Processing unit, see page 582.
- Mounting unit, see page 586.

## GSM unit quad-band

For configuring a redundant transmission channel or, if there is no network infrastructure available, the unit may be used for alarm forwarding. The alarm signal is designed in SMS format. The GSM Unit Quad-Band covers 4 GSM frequencies: 850 MHz, 900 MHz, 1800 MHz and 1900 MHz. A standard, commercially available SIM card for GSM must be provided by the customer.

GSM unit quad-band	Model No. DK
SMS function	<b>7320.820</b>

### Note:

The serial interface RS232 of the PU may only be assigned to one accessory module.



### Also required:

- Processing unit, see page 582.
- Mounting unit, see page 586.



## Fan Control System FCS

### Speed-controlled fan system

The Fan Control System regulates and controls the speed of up to 6 fans, 24 V DC. It may optionally be connected to the CMC III CAN-Bus unit DK 7030.030.

FCS	Model No. DK
Without fan	<b>7320.810</b>

### Functions:

- Speed-regulated speed control
- Fan speed monitoring
- Optional connection via Web/SNMP

### Note:

FCS fitted in fan roof, see page 224.



### Also required:

- Power pack DK 7030.060, see page 584.
- Connection cable DK 7200.210, see page 585.
- Fan DK 7320.812, see page 587.
- Extension DK 7320.814, see page 585.
- 1 U mounting unit 7320.440, see page 586.



## Fan 24 V DC for FCS

### with speed monitoring

Fan with integral speed monitoring with RJ 12 connector/connection cable 0.6 m for connecting to FCS DK 7320.810.

### Technical specifications:

- Rated voltage: 24 V DC
- Rated current: 0.28 A (max.)
- Rated output: 6.72 W (max.)
- Air throughput (unimpeded air flow): 175 m<sup>3</sup>/h
- Speed: 2650 rpm
- Noise level: 45 dB (A)

Packs of	Model No. DK
2	<b>7320.812</b>



### Also required:

RJ 12 extension, 1 m, DK 7320.814, see page 585.



## Universal lock unit

The security lock consists of a base unit and a lock counterpart. The base unit is attached to the enclosure frame. The lock counterpart is attached to the door.

### Technical specifications:

- Rated voltage: 24 V DC
- Rated current: 140 mA

Packs of	Model No. DK
1 set	<b>7320.730</b>

### Note:

Supplied without mounting kit.



### Also required:

CMC III CAN-Bus access DK 7030.200, see page 583.



# Door Control System

## Door Control System

For automatic opening of closed rack systems:

- In the event of cooling system failures.
- For extinguishing a fire using a fire extinguisher system.

### Note:

To be connected at rear:

- **Door Kit**  
Up to 16/2 door kits may be connected for automatic opening.
- **Door comfort handle or Door switch**  
Up to 16/2 door comfort handles/door switches may be connected for manual opening.
- Automatic opening is achieved by connecting to the PU/PU Compact. Independently of this, the doors may be opened using the door comfort handle/door switch.
- In the event of a power failure, the doors will open.
- The front and rear door must always be opened.



### Also required:

CMC III Processing Unit/Compact, see page 582.

### System representation

#### Door Control System:

- A maximum of 16 door control systems per processing unit
- A maximum of 2 door control systems per processing unit may be connected

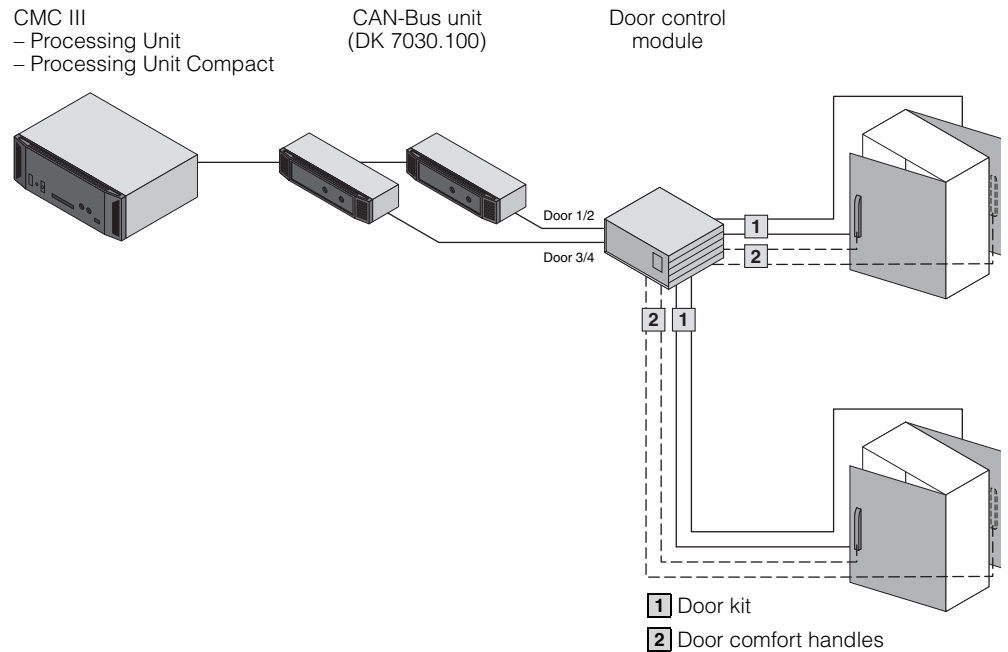

# Door Control System

## Door control module

For activation of up to 4 door kits There is 1 control channel available per 2 door kits (e.g. front and rear door). There is optionally a normally-closed contact integrated for each door output, which is used to connect the automatic door switch, door comfort handle or a customer-specific system (e.g. room extinguisher system).

<b>Model No. DK</b>	<b>7320.790</b>
W x H x D mm	136 x 44 (1 U) x 129
Rated voltage	24 V DC
Door outputs	4 x 24 V DC, 400 mA
Ports for CMC III CAN-Bus unit	2 x RJ 12
Normally closed contacts	Connection must be designed for 30 V DC, 1 A
Temperature application range	+5°C to +45°C
Humidity application range	5% to 95% relative humidity, non-condensing
IP protection category	IP 40 to IEC 60 529



### Also required:

- Mounting unit DK 7320.440, see page 586.
- AC power pack 230 V, see page 584.
- Connection cable, see page 585.



## Door kit

- Fitting a standard door for the Door Control System
- The door kit operates with a gas pressure damper system, allowing the door to be opened in any emergency situation. The doors are kept closed by a magnet system, which unlike mechanical lock systems will release the door in every instance.
- The door kit is connected and activated using the corresponding door control module DK 7320.790.

Version for	Packs of	Model No. DK
2-piece door	1	<b>7320.792</b>
1-piece glazed door	1	<b>7320.795</b>
1-piece sheet steel door	1	<b>7320.796</b>

### Supply includes:

- Gas pressure damper
- Cable harness
- Magnetic lock
- Assembly parts



## Door comfort handle

### with door opener function

By actuating the lock mechanism, the door is released via the automatic door opening system. Prepared for the installation of standard commercially available semi-cylinders, 40 mm, and SZ lock and push-button inserts. Length: 302 mm.

### Technical specifications:

- Rated voltage: 24 V DC
- Rated current: max. 3 A
- Connection cable: Length 3 m
- Temperature application range: +5°C to +40°C

Design	Model No. DK
RAL 7035	<b>7320.794</b>



### Also required:

Handle adaptor for mounting on glazed door TS 8611.080, see page 402.



## Door switch

Switch for connecting to the normally closed contacts of the door control module (DK 7320.790) for manual door opening.

It is mounted on the 25 mm pitch pattern of the TS 8 frame section.

### Technical specifications:

- Installation Ø 16.2 mm
- 250 V/2 A

Packs of	Model No. DK
1	<b>7320.793</b>

### Supply includes:

- 3 m connection cable
- Mounting bracket
- Assembly parts



# Monitor/keyboard unit



## Monitor/keyboard unit, 1 U

With 17" TFT display and VGA/DVI connection

### Benefits:

- High-quality manufacturing
- Analog and digital video input
- Separate numerical keypad
- Optionally with integrated KVM switch for up to 32 server connections in just 1 U
- Low energy consumption
- Simple, one-man installation

### Technical design

- 17" (432 mm) TFT display
- Native resolution 1280 x 1024
- Format 4 : 3
- 16.7 million colours
- Brightness approx. 350 cd/m<sup>2</sup> (typ.)
- Contrast ratio approx. 1000 : 1
- Mains voltage 100 – 240 V AC, 50 – 60 Hz
- Ambient temperature +5°C to +45°C (in operation)
- Max. power consumption in operation, without optional KVM switch: 32 W
- Max. power consumption when closed, without optional KVM switch: < 1 W
- Rear connections: Mains power, VGA, DVI-D, PS/2, USB, power supply for KVM
- Lockable at the front
- Cables are safely routed in the energy chain



### Accessories:

For monitoring several servers:  
KVM switches, see page 591.

Width mm	Height U	Depth mm	Installation depth mm	Packs of	Colour	Keyboard	Model No. DK
482.6 (19")	1	680	680 – 850	1	RAL 7035	German	<b>9055.310</b>
						English	<b>9055.312</b>
					RAL 9005	German	<b>9055.410<sup>1)</sup></b>
						English	<b>9055.412<sup>1)</sup></b>

Other country-specific versions available on request.

<sup>1)</sup> Extended delivery times.

# KVM switches

## KVM switches

With these ultra-compact KVM switches for 482.6 mm (19") mounting or for mounting behind a Rittal monitor/keyboard unit, space-saving server administration becomes possible in any IT rack. The Rittal SSC switching system grows flexibly with your requirements. With the SSC compact/view 32 Cat, the computers are connected via Cat cables and converters (SSC converter). The signals for video, keyboard and mouse are transmitted via a shared cable.

Processor-controlled keyboard and mouse emulation for each channel ensures fault-free booting and reliable switching between the connected computers. The SSC view optionally extends the Rittal monitor/keyboard unit to include the function of an 8- or 32-port KVM switch, without requiring an additional U in the server rack for mounting.

	<sup>1</sup> SSC view 8 USB	<sup>1</sup> SSC view 32 Cat	<sup>2</sup> SSC compact 32 Cat
Installation type	For mounting behind the monitor/keyboard unit DK 9055.XXX		For mounting on 482.6 mm (19") levels
<b>Model No. DK</b>	<b>7552.002</b>	<b>7552.100</b>	<b>7552.110</b>
<b>Equipment</b>	<b>8 Port KVM</b>	<b>32 Port KVM</b>	<b>32 Port KVM</b>
Number of computers in stand-alone mode	8	32	32
Number of users (with password protection)	1	1	1
Cascading <sup>2)</sup> as slave to SSC view/compact 32 Cat (with OSD transfer)	–	■	■
OSD menu with mouse operation (English)	■	■	■
OSD superimposed on computer screen (may be de-activated)	■	■	■
OSD display of channels used	■	■	■
Hotkeys for computer selection	■	■	■
Autoscan	■	■	■
Autoskip (skip over unused channels)	■	■	■
Type of cable to computer or to SSC Connect	VGA/HD15 and PS/2	Cat 5, 6	Cat 5, 6
Maximum cable length, SSC to computer (depending on cable quality)	4 m	15 m (30 m)	15 m (30 m)
Port and system support	PS/2 and USB	PS/2, USB, SUN-USB	PS/2, USB, SUN-USB
Automatic cable alignment (manually readjustable)	–	■ <sup>1)</sup>	■ <sup>1)</sup>
LED displays (rear)	None	Power	Power
Maximum video resolution (depending on cable length)	1280 x 1024@85 Hz	1920 x 1440@75 Hz	1920 x 1440@75 Hz
Bandwidth	200 MHz	250 MHz	250 MHz

Computer	SUB-HD15 / PS/2 / USB-B	RJ 45	RJ 45
Strengtheners	SUB-HD15 / PS/2 / USB-B	SUB-HD15 / PS/2	SUB-HD15 / PS/2
Cascading port (connection for slave, SSC compact only)	–	RJ 45	RJ 45
Service (for firmware update)	–	Jack 2.5 mm	Jack 2.5 mm
12 V DC power supply (from monitor/keyboard unit)	■	■	–
Power supply 100 – 240 V, 50/60 Hz (internal power pack, IEC 320, C14)	–	–	■
Power consumption (approx.)	10 W	13 W	13 W
Operating temperature	+5 to +45°C	+5 to +45°C	+5 to +45°C
Protection category	IP 20	IP 20	IP 20
Enclosure	Material	Sheet steel	Sheet steel
	Surface finish	Powder-coated	Powder-coated
Colour	RAL 9006	RAL 9006	RAL 7035
Dimensions (excluding protruding parts) approx. W x H x D mm	482.6 x 44 x 140	482.6 x 44 x 140	482.6 x 44 x 140
Certification	CE	CE	CE

<sup>1)</sup> With a cable length of max. 15 metres, there is no need for any manual video readjustments. Above and beyond this, the maximum permissible cable length is approximately 30 metres (depending on the cable quality). Here, manual readjustment may be required.

<sup>2)</sup> Up to 3 SSC compact/view 32 Cat may be cascaded to one master (max. 125 servers on 1 user).

### Accessories

Mains connection cable (for SSC compact only)	–	–	7200.210
3 CPU cable VGA/PS/2 (with lockable PS/2 connectors, at both ends)	2 m	7552.120	–
	4 m	7552.140	–
3 CPU cable VGA/USB, USB-A (computer) to USB-B (switch)	2 m	7552.122	–
	5 m	7552.142	–
SSC converter PS/2	–	7552.201	7552.201
SSC converter USB	–	7552.202	7552.202



# KVM switches

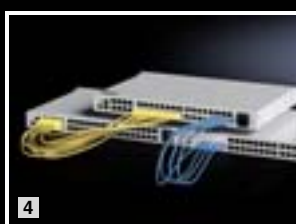

## SSC premium 2/16, 4/32, 8/32

### Highly integrated KVM matrix based on Cat technology

KVM switching technology which adapts flexibly to your future requirements. Thanks to Cat technology (transmission of the signals for keyboard, video and mouse via a Cat cable), the amount of cabling work required can be significantly reduced. Super-compact 1 U systems with up to 32 server ports are supported. The full matrix switches offer each of the connected users unrestricted, simultaneous access to the chosen computer system. There are various console types available for administration.

By separating the hardware switch and operating console, the systems may be adapted to any required computer environment. On the computer side, conversion to standard PC interfaces is achieved via separate converters which optimise all signals (keyboard, video, mouse) for transmission via the Cat cable.

**Material:**  
Sheet steel

**Colour:**  
RAL 7035

**Protection category:**  
IP 30

#### ! Also required:

- SSC converter (depending on the number of computers) and at least one operator console, see page 594/595.
- Mains connection cable (DK 7200.210), see page 585.

**Connection example:**  
Available on the Internet.

Rittal SSC premium	[1] 2/16	[2] 4/32	[3] 8/32
<b>Model No. DK</b>	7552.020 <sup>1)</sup>	7552.030 <sup>1)</sup>	7552.040 <sup>1)</sup>
<b>Equipment</b>			
Number of computers in stand-alone mode	16	32	32
[4] Number of computers with cascading as full matrix (max. 3 levels, type-identical SSC premium)	1024	2048	512
Number of users (local, remote, IP), mixed and simultaneous	2	4	8
Number of users that may be administered (with allocation of rights)	128	128	128
Integral user/computer administration	■	■	■
Support of central directory services and authentication systems	–	–	■
OSD menu with mouse operation (English)	■	■	■
Display of system structure in the OSD per computer (path)	■	■	■
OSD superimposed on computer screen (may be de-activated)	■	■	■
OSD display of channels used	■	■	■
Hotkeys for computer selection	■	■	■
Type of cable to SSC converter and SSC console	Cat 5, 6	Cat 5, 6	Cat 5, 6
Maximum cable length console – computer (depending on cable quality)	300 m	300 m	300 m
Port and system support (SSC converter)	PS/2, USB, SUN-USB/VT100	PS/2, USB, SUN-USB/VT100	PS/2, USB, SUN-USB/VT100
Automatic video/cable alignment (manually readjustable)	■	■	■
<b>LED displays, front</b>			
Power/Power Redundant	■	■	■
System Ready (illuminates as soon as the system booting process has been completed without error)	■	■	■
Status Switch (illuminates when the SSC is operational)	■	■	■
<b>LED displays, rear</b>			
Computer port busy/connected	yellow/green	yellow/green	yellow/green
Console port busy/connected	yellow/green	yellow/green	yellow/green
Network port full duplex/half duplex	–	–	yellow/flashing
Network port connection status/activity	–	–	green/flashing
Maximum video resolution (depending on cable length)	1920 x 1440 @ 75 Hz	1920 x 1440 @ 75 Hz	1920 x 1440 @ 75 Hz
Bandwidth	250 MHz	250 MHz	250 MHz
Activation of switchable socket strip (on/off)	■	■	■
<b>Connections</b>			
Computers/consoles	RJ 45	RJ 45	RJ 45
Service (front) for firmware update	Jack 2.5 mm	Jack 2.5 mm	Jack 2.5 mm
RS232 (front)	RJ 11	RJ 11	RJ 11
Network	–	–	2 x RJ 45
Power supply via IEC 320 connection (IEC 320 C13)	■	■	■
Redundant power supply (with SSC power pack)	4-pole mini-DIN	4-pole mini-DIN	4-pole mini-DIN
Power supply (internal power pack)	90 – 264 V/ 47 – 63 Hz	90 – 264 V/ 47 – 63 Hz	90 – 264 V/ 47 – 63 Hz
External power supply, redundant	12 V/approx. 1 A	12 V/approx. 1 A	12 V/approx. 1 A
Power consumption (approx.)	12 W	13 W	16 W
Dimensions (excluding protruding parts) approx. W x H x D mm	482.6 x 44 x 286	482.6 x 44 x 286	482.6 x 44 x 286
Conformity	CE	CE	CE

<sup>1)</sup> Extended delivery times.



# KVM switches

## SSC Duo 16

Ultra-compact KVM switch with both a local access and an IP access. These two users are able to access the connected servers in parallel/simultaneously.

Up to 16 servers may be connected using Cat cables and SSC converter adaptors (available in a PS/2 and USB variant). Processor-controlled keyboard and mouse emulation for each channel ensures fault-free booting and reliable switching between the connected computers. The integral IP console supports location-independent access to the servers down to BIOS level.

Access may be made both via the integral Web interface (via Java client) and via client software for Windows and selected Linux distributions, available free of charge. The switch includes rights administration for up to 16 user profiles.

### Material:

Sheet steel, powder-coated

### Colour:

RAL 7035

### Protection category:

IP 40



### Also required:

One SSC converter adaptor DK 7552.201 (PS/2) or DK 7552.202 (USB) is required for each connected computer, see page 595.

### Note:

Software updates are available at [www.rittal.com](http://www.rittal.com)

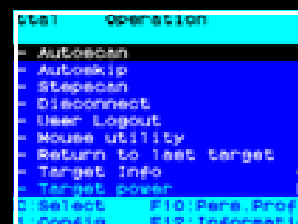

Model No. DK	SSC Duo 16 7552.510
<b>Equipment</b>	
No. of computers that may be connected	16
Number of users (local, IP), mixed and simultaneous	2
Number of users that may be administered (with allocation of rights)	16
Integral user/rights administration (also via directory services)	■
OSD menu with mouse operation (English)	■
OSD superimposed on computer screen (may be de-activated)	■
OSD display of channels used	■
Hotkeys for computer selection	■
Type of cable to SSC converter and SSC console	Cat 5, Cat 6
Maximum cable length SSC Duo 16 – computer (depending on cable quality)	30 m
Port and system support (SSC converter)	PS/2, USB
Automatic video and cable alignment (manually readjustable)	■
<b>LED displays</b>	
Power	■
System Ready (illuminates as soon as the system booting process has been completed without error)	■
Status Switch (illuminates when the SSC is operational)	■
Network port (activity, connection status)	■
Maximum video resolution (depending on cable length)	1920 x 1440 @ 75 Hz
Bandwidth	250 MHz
<b>Connections</b>	
Computers/consoles	RJ 45
Service for firmware update	Jack 2.5 mm
Network	RJ 45
Power supply via IEC 320 connection (EN 60 320 C14)	■
Power supply (internal power pack)	90 – 264 V/47 – 63 Hz
Power consumption (approx.)	20 W
Dimensions approximately W x H x D mm	482.6 mm x 1 U x 290 mm
Certifications	CE
<b>Accessories</b>	
SSC converter PS/2	7552.201
SSC converter USB	7552.202
Cat 5 cable 2 m	7320.472
Cat 5 cable 5 m	7320.475
Cat 5 cable 10 m	7320.481
Cat 5 cable 15 m	7320.485
Mains connection cable (earthing-pin)	7200.210

# KVM switches



## Console local

### for SSC premium

For installation in

- 482.6 mm (19")
- at the rear of 15"/17" monitor unit (9055.XXX)

As the link between the keyboard, monitor, mouse (or the Rittal monitor/keyboard unit) and the SSC premium. Via the console, the computer systems connected to the switch may be conveniently selected and administered using the OSD.

Power supply is optionally via the Rittal monitor/keyboard unit or, in the case of stand-alone 482.6 mm (19") installation, via the SSC Power Pack (DK 7552.220).

#### Material:

Sheet steel

#### Colour:

RAL 9006 (white aluminium)

#### Supply includes:

Assembly parts.

#### Technical specifications:

- Video resolution: Max. 1920 x 1440 @ 75 Hz (depending on the cable length)
- Video bandwidth: 250 MHz
- Voltage supply: 12 V DC (from monitor/keyboard unit) or via SSC Power Pack DK 7552.220
- Dimensions:  
W x H x D mm: 325 x 44 x 85 (stand-alone)  
W x H x D mm: 482.6 x 44 x 140 (built into 482.6 mm/19")

Type	Packs of	Model No. DK
Console local	1	7552.200

Extended delivery times.

#### Connections (jack):

- PS/2 (keyboard/mouse)
- USB-A (keyboard/mouse)
- D15 (VGA-Video RGB & Sync.)
- RJ 45 (KVM matrix connection)
- Mini-DIN 4 (12 V power supply)



#### Also required:

- Only for 482.6 mm (19") installation without monitor/keyboard unit:  
SSC Power Pack DK 7552.220, see page 596.
- Cat 5 patch cable, see page 596.



## Console Cat 5

### for SSC premium

This remote console forms the link between the keyboard, monitor, mouse and the SSC premium.

Via the console, the computer systems connected to the switch may be conveniently selected and administered using the OSD. The signals are forwarded via Cat cable, depending on the cable quality up to 300 m, via the KVM matrix to the connected computers. Additionally, 2 local PCs may be connected if required.

The console is designed as a compact desktop enclosure with integral wide-range power pack (482.6 mm (19") versions on request).

#### Material:

Sheet steel

#### Colour:

RAL 7035

#### Technical specifications:

- Video resolution: Max. 1920 x 1440 @ 75 Hz (depending on the cable length)
- Video bandwidth: 250 MHz
- Power supply (internal power pack):  
100 – 280 V, 50 – 60 Hz/0.2 A
- Dimensions:  
W x H x D mm: 270 x 44 x 220

Type	Packs of	Model No. DK
Console Cat 5	1	7552.212

Extended delivery times.

#### Connections (jack):

- PS/2 (keyboard/mouse) USB-A (keyboard/mouse)
- SUB-HD15 (VGA video RGB & Sync.)
- 2 x Cat (RJ 45) to connect 2 local PCs via SSC converters (VGA, PS/2 or USB)
- RJ 45 (KVM matrix connection) IEC 320 C-14 (power supply)
- Mini-DIN 4 (redundant power supply)



#### Also required:

- Cat 5 patch cable, see page 596.
- SSC converter for local PCs, see page 595.
- Mains connection cable (e.g. DK 7200.210), see page 585.

## Console IP

### for SSC premium (KVM-over-IP)

With the IP remote console, computers connected to the KVM matrix may be accessed via any given TCP/IP network. The SSC Console IP is a hardware solution, and guarantees remote monitoring of the computers even during the booting phase, down to BIOS level. With the system operational, the target computers may be accessed at any time via web browsers and Java applets (irrespective of the operating system), or if Java is not supported, via optimised client software for common operating systems. This client has extended functions (e.g. a setup mode) and can be used throughout the company without restriction. In addition to remote access via IP, the SSC Console IP also has an integral local console port (competing with IP access) for connecting the keyboard, mouse and monitor locally in the rack.

Access to the console is additionally password-protected. KVM access to the web interface may be encrypted via HTTPS (SSL 128-bit). In order to further increase failsafeness, the SSC console IP may also be extended with a redundant power pack via the SSC Power Pack (DK 7552.220).

**Material:**  
Sheet steel

**Colour:**  
RAL 7035

Type	Packs of	Model No. DK
Console IP	1	7552.214

Extended delivery times.

#### Technical specifications:

- Video resolution: max. 1280 x 1024 @ 75 Hz
- Network: 10/100 MBit/s
- Power pack: 100 – 240 V AC, 50/60 Hz
- Dimensions:  
W x H x D mm: approx. 440 x 44 x 380

#### Connections (jack):

- PS/2 (keyboard/mouse)
- SUB-HD15 (VGA video, RGB and Sync.)
- RJ 45 (KVM matrix connection)
- RJ 45 (Ethernet)
- Sub-D (RS232)
- IEC320 C14 (power supply)
- Mini-DIN 4 (redundant power supply)

#### Supply includes:

Includes client software for the latest Windows operating systems (MS Windows XP Professional, Server 2003, Server 2008, Windows 7) and Linux Distribution (RedHat, Suse) in German and English.



#### Also required:

- Mains connection cable (DK 7200.210), see page 585.
- Cat 5 patch cable, see page 596.



## SSC converter

### for SSC premium/Duo 16/view 32 cat

The SSC converters convert the signals for keyboard, video and mouse from the connected computer to the Cat cable.

There is a choice of three different variants for connecting PCs with PS/2 or USB ports, and a separate version for use with SUN computers with a USB port. One converter is required for each computer. Every SSC converter has a unique identification number (Unique ID).

SSC converter	Packs of	Model No. DK
PS/2	1	7552.201
USB	1	7552.202
SUN-USB (German)	1	7552.203
SUN-USB (US English)	1	7552.204

#### Technical specifications:

- Video resolution: 1600 x 1200 @ 85 Hz
- Power supply:  
5 V DC/approx. 150 mA (from computer)
- Certification: CE
- Dimensions: approx. 65 x 45 x 20 mm



## SSC converter VT100 (RS232)

### for SSC premium/Duo 16

With this SSC adaptor, active network components (such as an Ethernet switch) with a serial management port which support the VT100 terminal mode may be integrated into the SSC premium KVM system.

#### Connections:

- Sub-D 9-pole (RS232)
- RJ 45 (KVM matrix connection)
- Mini-DIN 4 (power supply)

#### Supply includes:

- Power pack  
(100 – 240 V, 50/60 Hz/s secondary, 12 V/0.7 A)
- Mains connection cable DK 7200.210

	Packs of	Model No. DK
SSC converter VT100	1	7552.205

Extended delivery times.



#### Also required:

- Cat 5 patch cable, see page 596.



# KVM switches



## CPU cable

### for SSC view 8/USB, PS/2 and USB

Combination connection cable between SSC view 8 and the individual servers, each with 2 HD 15 connectors for video, plus lockable PS/2 connectors at both ends for the keyboard and mouse, colour-coded.

USB cable with USB-A and USB-B connector (connection switch) and VGA cable.

Connection	Cable length	Model No. DK
PS/2	2 m	<b>7552.120</b>
PS/2	4 m	<b>7552.140</b>
USB	2 m	<b>7552.122</b>
USB	5 m	<b>7552.142</b>



## Cat 5 patch cable

Flexible, pre-configured Cat 5 STP patch cable with shielded RJ45 connectors for connecting the SSC converter and SSC console to the SSC premium switch. The cables are wired 1 : 1 to AT&T 258A/T568B and comply with ISO/IEC 11801, UL E151955.

**Colour:**  
Grey

Length m	Packs of	Model No. DK
2	4	<b>7320.472</b>
5	4	<b>7320.475</b>
10	1	<b>7320.481</b>
15	1	<b>7320.485<sup>1)</sup></b>

<sup>1)</sup> Extended delivery times.



## SSC Power Control

### for SSC premium

With this adaptor, the Power Control Unit socket strips (DK 7200.001) and the active PSM module (DK 7856.201) may be switched individually or in pairs (for servers with redundant power supply). Control is via the OSD integrated into the SSC premium.

Up to 8 PSM and PCU modules may be switched (max. 64 EN 60 320 C13 slots).

#### Note:

- The connection cable between the SSC premium and the SSC Power Control with a length of 2.5 m is included with the supply.
- Only suitable for use with SSC premium switches and modules 7856.201 and 7200.001.

	Packs of	Model No. DK
SSC Power Control	1	<b>7552.420</b>

#### ! Also required:

- Power pack (DK 7201.210).
- Mains cable (DK 7200.210), see page 585.
- At least 1 active PSM/PCU module, DK 7856.201 only, see page 203 and DK 7200.001, see page 510.
- Cat 5 patch cable, see page 596.



## SSC Power Pack

In order to increase fail-safeness, we recommend configuring a redundant power supply to the SSC premium and the connected user consoles. This compact wide-range power pack (AC: 100 – 240 V, 50/60 Hz, DC: 12 V/5 A) with IEC 320 socket (EN 60 320) and Mini-DIN 4 connector is ideal for this purpose. Should the first power supply of the internal power pack fail, the functionality of the KVM switch is maintained.

**Supply includes:**  
Assembly parts.

SSC	Packs of	Model No. DK
SSC Power Pack	1	<b>7552.220</b>

#### ! Also required:

Connection cable for power pack, see page 585.

# Dynamic Rack Control

## RFID mounting frame

### for TS 8

With integral RFID reader (aerial) to accommodate the 482.6 mm (19") built-in components. The mounting frame may be depth-variably secured in the TS 8 and is used to structure the front 482.6 mm (19") mounting level.

Position detection of the components is accurate to within 1/3 U, therefore there are 3 aerial elements and signalling LEDs integrated into each U. The installation position of the components is correctly recognised even if they are not located precisely in the height pitch pattern. Reading and writing of the RFID tags is likewise signalled by one LED in each case.

### Load capacity:

Max. 1000 kg static load with even distribution across 20 482.6 mm (19") mounting levels.

### Material:

Sheet steel, zinc-plated, passivated

### Supply includes:

Assembly parts.

For TS 8		U	RFID mounting frame, front	Mounting frame, rear
Width mm	Height mm		Model No. DK	Model No. DK
600	2000	42	<b>7890.206</b>	<b>7856.719</b>
800	2000	42	<b>7890.208</b>	<b>7856.731</b>
600	2200	47	<b>7890.226</b>	<b>7856.722</b>
800	2200	47	<b>7890.228</b>	<b>7856.734</b>

Other sizes available on request.



### Also required:

A matching mounting frame without RFID reader (see ordering table) to emulate the rear mounting level.

The mounting frame must be connected to the RFID controller DK 7890.500, see page 597.



## RFID tags

1 RFID tag is required for each component. Each tag has a "Unique ID" (UID, not sequential), which cannot be altered, data is stored on the tag in conformity with ISO 15693. The tags are unwritten in their delivered state. The tag is stuck to the inside/right of the 482.6 mm (19") mounting bracket. For this purpose, the tag has got an adhesive surface. The component is later screw-fastened to the 482.6 mm (19") level.

Passive, writable RFID tag (13.56 MHz)	
Packs of	Model No. DK
20	<b>7890.020</b>



## RFID controller

This controller connects the RFID reader (aerial) of the 482.6 mm (19") mounting frame to the CMC. In this way, the CMC is able to notify automatic changes, graphically depict the enclosure with the built-in components, and list capacity management.

One RFID controller is required per rack.

### Enclosure dimensions W x H x D:

136 x 44 (1 U) x 129 mm

### Material:

Plastic

### Rated voltage:

24 V DC

### Connections:

- RJ 45 jack (connection to CMC)
- 2 x Mini-DIN (connection of RFID frame & floor-reader)

Packs of	Model No. DK
1	<b>7890.500</b>



### Also required:

Cat 5 patch cable, see page 596.





# System accessories for the human/machine interface

## Handles/external mounting accessories

Handle set .....	600
Handles .....	602
Clipboard.....	603
Display board with wall bracket .....	603
Enclosure surface connector .....	603

## Front assembly

Front panels.....	604
Mounting kit.....	605

## Monitors

TFT monitor.....	606
Power pack.....	606
Connection cable .....	606
TFT holder .....	607

## Keyboards, supports and drawers

Keyboards .....	608
Supports .....	610
Drawers .....	612

## Interfaces

Interface box .....	616
Interface extension .....	616
Interface flaps.....	617

## Signal pillars

Signal pillars, LED compact .....	618
Signal pillars, modular .....	619

# Handles



## Handle set

### for Comfort Panel

For external mounting on corner pieces, also suitable for retro-fitting.

#### Material:

- Handle tube: Aluminium
- Handle holder: Die-cast zinc
- Covers: Polyamide

#### Surface finish:

- Handle tube: Natural-anodised
- Handle holder: Powder-coated

#### Colour:

- Handle holder: RAL 7024
- Covers: Similar to RAL 7024

#### For horizontal mounting

With front panel width	Packs of	Model No. CP
482.6 mm (19")	1 set	<b>6375.010</b>
520 mm	1 set	<b>6375.000</b>

#### Supply includes:

- Handle tube, Ø 20 mm
- 2 handle holders
- 2 covers
- Assembly parts

#### Note:

Shorter heights and widths can be achieved by cutting the handle tube to length. For enclosures with 74 mm depth, cannot be mounted on the same side as the support arm connection.



#### Accessories:

- Clipboard, see page 603.
- Display board see page 603.

#### For vertical mounting

With front panel height	Packs of	Model No. CP
400 mm	1 set	<b>6375.040</b>
500 mm	1 set	<b>6375.050</b>
600 mm	1 set	<b>6375.060</b>

#### Supply includes:

- 2 handle tubes, Ø 20 mm
- 4 handle holders
- 4 covers
- Assembly parts



## Handle set

### for Optipanel

For external mounting on corner pieces, also suitable for retro-fitting.

#### Material:

- Handle tube: Aluminium
- Handle holder: Die-cast zinc
- Covers: Polyamide

#### Surface finish:

- Handle tube: Natural-anodised
- Handle holder: Powder-coated

#### Colour:

- Handle holder: RAL 7035
- Covers: RAL 7024

#### For horizontal mounting

With front panel width	Packs of	Model No. CP
482.6 mm (19")	1 set	<b>6385.010</b>
520 mm	1 set	<b>6385.000</b>

#### Supply includes:

- Handle tube, Ø 25 mm
- 2 handle holders
- 2 covers

#### Note:

Shorter heights and widths can be achieved by cutting the handle tube to length. For enclosures with 100 mm depth, cannot be mounted on the same side as the support arm connection.



#### Accessories:

- Clipboard, see page 603.
- Display board see page 603.

#### For vertical mounting

With front panel height	Packs of	Model No. CP
400 mm	1 set	<b>6385.040</b>
500 mm	1 set	<b>6385.050</b>
600 mm	1 set	<b>6385.060</b>

#### Supply includes:

- 2 handle tubes, Ø 25 mm
- 4 handle holders
- 4 covers



## Handle set

For vertical and horizontal mounting on all surfaces.  
Overall length: 420 mm.

### Material:

- Handle tube: Aluminium
- Tube holder: Die-cast zinc

### Surface finish:

Handle tube: Natural-anodised

### Colour:

Conduit holder: RAL 7035

### Supply includes:

- 4 conduit holders
- 2 handle tubes

Packs of	Model No. SZ
1 set	2389.000



### Accessories:

- Clipboard, see page 603.
- Display board, see page 603



## Handle frame

for operating housing with display panel front

### Colour:

RAL 8019

### Supply includes:

- Square aluminium tube
- Plastic corner bracket
- End caps
- Assembly parts

### Note:

Command panel with display panel front  
CP 6662.500,  
see page 123.

Model No. CP	6190.000
Operating housing width (B1) mm	600
Width of the horizontal rectangular tube (B2 = B1 + 48) mm	648
Height of the vertical rectangular tube (H1) mm	299
Hole distance between the assembly holes (H2) mm	249

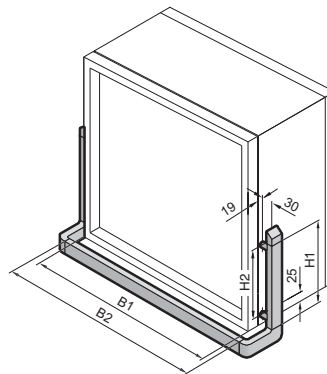

## Aluminium strip

### For

- One-piece console
- Surfaces

Prevents wiring plans etc. from slipping.

For console	Length mm	Packs of	Model No. AP
AP	1183	3	2682.000

May be cut to length for other dimensions.



# Handles, external mounting accessories

## Handles

For horizontal or vertical attachment to the enclosure panel of:

- Comfort Panel,
- Optipanel,
- Other enclosures or
- Surfaces

Mounting holes and surfaces without fins are required for assembly purposes. For the Comfort Panel version with fins, selectable via configurators at [www.rittal.com](http://www.rittal.com), corresponding milling work may be carried out. To this end, please specify "Prepared for handle set CP 6107.XXX" for the command panel.

### Material:

- Handle holder: Die-cast zinc
- Cover bungs: Plastic
- Handle tube: Aluminium

### Surface finish:

Handle tube: Powder-coated

### Colour:

- Handle holder: RAL 7035
- Cover bungs: Similar to RAL 7035
- Handle tube: Similar to RAL 9006



## Corner handle

### Supply includes:

- 4 handle holders
- 2 handle tubes
- Assembly parts

Mounting on enclosure corner

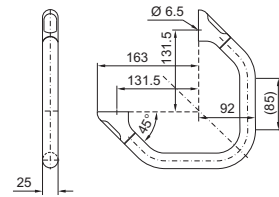

Packs of	Model No. CP
1 set	6107.000



For external mounting on straight surfaces (90° rotation of handle holder)

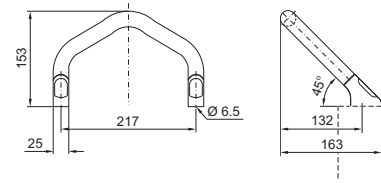

## U handle

### Supply includes:

- 2 handle holders
- 1 handle tube
- Assembly parts

For front panel size	Packs of	Model No. CP
≥ 7 U	1 set	6107.100
482.6 mm (19")	1 set	6107.200

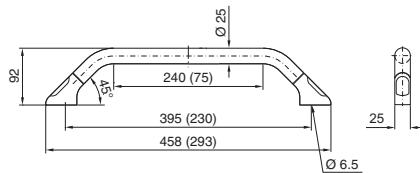

### Note:

Dimensions in brackets for CP 7 U.

### Accessories:

For CP 6107.200:

- Clipboard, see page 603.
- Display board, see page 603.

# External mounting accessories

## Clipboard

For securing operating instructions or plans (A4 size) at eye level.

Prepared for mounting on the right-hand side; mounting on the left is also possible by unscrewing and moving the clip part.

For mounting purposes, a straight tube length of  $\geq 200$  mm,  $\varnothing 20$  mm or  $\varnothing 25$  mm, is required.

### Material:

- Clipboard: Sheet steel
- Clip part: Aluminium

### Surface finish:

Clip part: Natural-anodised

### Colour:

RAL 7035

Width mm	Height mm	Packs of	Model No. CP
225	315	1	6013.000

### ! Also required:

- Handle set SZ 2389.000, see page 601 or
- Handle set for Comfort Panel, see page 600 or
- Handle set for Optipanel, see page 600 or
- U handle CP 6107.200, see page 602.



## Display board with bracket

To accommodate test plans, documents etc. in A4 format.

### Assembly:

- On surfaces,
- On a 25 mm pitch pattern of the TS frame or rail system,
- On handle set  $\varnothing 20$  mm or  $\varnothing 25$  mm.

### Supply includes:

- Display boards
- Wall bracket
- Assembly parts

Packs of	Model No. CP
1 set	6013.100

### + Accessories:

- Handle set SZ 2389.000, see page 601 or
- Handle set for Comfort Panel, see page 600 or
- Handle set for Optipanel, see page 600 or
- U handle CP 6107.200, see page 602.



## Enclosure surface connector

To accommodate keyboard support (SM 2383.000, see page 610).

### Material:

- Surface connector: Extruded aluminium section
- Side cover: Sheet steel

### Surface finish:

Surface connector: Natural-anodised

### Colour:

RAL 7024

### Supply includes:

Assembly parts.

Packs of	Model No. SM
1 set	2383.010

Mounting on surfaces

Mounting underneath surfaces

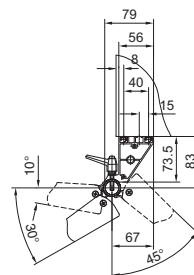
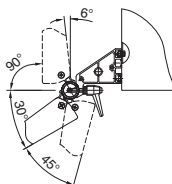

# Front assembly

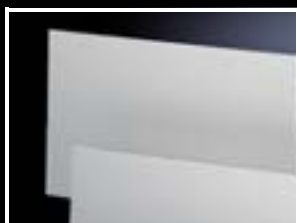

## Front panels for Comfort Panel and Optipanel

**Material:**  
Aluminium, 3 mm

**Surface finish:**  
Natural-anodised

**Note:**  
Mounting kits included with the supply of 520 mm wide standard enclosures.

### With mounting hole

Width mm	Height mm	Model No. CP
482.6 (19')	155.0 (3.5 U)	<b>6027.000</b>
482.6 (19')	310.3 (7 U)	<b>6028.000</b>

### With threaded bolts M5

Width mm	Height mm	Model No. CP
482.6 (19')	155.0 (3.5 U)	<b>6027.010</b>
482.6 (19')	310.3 (7 U)	<b>6028.010</b>
520	400	<b>6028.014</b>
520	500	<b>6028.015</b>
520	600	<b>6028.016</b>



### Also required:

Mounting kit  
 – for Comfort Panel CP 6053.800,  
 see page 605,  
 – for Optipanel CP 6053.000/.500,  
 see page 605.

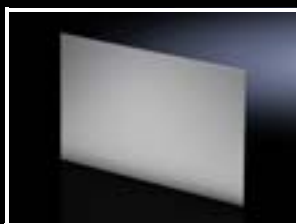

## Front panels for Compact Panel

**Material:**  
Aluminium, 3 mm

**Surface finish:**  
Natural-anodised

Size W x H mm	To fit Compact Panel	Model No. CP
178 x 200	CP 6340.000	<b>6028.500</b>
178 x 350	CP 6340.100	<b>6028.510</b>
252 x 200	CP 6340.300	<b>6028.530</b>
252 x 350	CP 6340.400	<b>6028.540</b>



## Cover plate for support arm connection

For secure sealing of an unrequired support arm connection in the enclosure.

**Material:**  
Sheet steel

**Supply includes:**  
Seal and assembly parts.

### Note:

If with

- Comfort Panel
- Optipanel
- Compact Panel

command panels, there are already 2 support arm cut-outs provided, a cover plate is included with the supply of the enclosure.

Support arm connection	Surface finish	Model No. CP
CP-S	Spray-finished in RAL 7024	<b>6505.200</b>
CP-L, Ø 130 mm	Zinc-plated, passivated	<b>6505.500</b>
CP-L, □ 120 x 65 mm	Zinc-plated, passivated	<b>6505.100</b>

# Front assembly

## Mounting kit

### for Optipanel

For installing

- Aluminium front panels
- Command panels
- Keyboards

### For holes

#### Supply includes:

Packs of  
30 retaining claws, captive nuts, screws  
and sealing washers.

For front panels	Thread	Model No. CP
Others	M4	6058.000
Rittal and others	M5	6053.000

### For threaded bolts

#### Supply includes:

Packs of  
10 retaining claws and cap screws.

For front panels	Thread	Model No. CP
Others	M4	6058.500
Rittal and others	M5	6053.500 <sup>1)</sup>

<sup>1)</sup> For the installation of TFT monitors 15", 17" and 19".

### For screw clamp

#### Supply includes:

Packs of  
4 pressure plates,  
4 attachment strips.

#### Note:

Command panels  
TP 277 6", OP 277 6", MP 277 10" Touch,  
MP 377 12" Touch, MP 377 15" Touch  
are installed using an adaptor plate (included  
with the supply subject if selected accordingly,  
or available on request).

For direct installation of	Model No. CP
Siemens Sinumerik: OP 010, OP 010C, OP 012, OP 015, MCP 483, PP 012, Querty 19", KB 483C, TP 015A	6053.210
Siemens Simatic: Panel PC 477, 577, 677, 677B: 12.1" Touch, 15.1" Touch, 12.1" keys, 15.1" keys, 19" Touch <sup>1)</sup> Panel PC 877: 15.1" Touch, 12.1" keys, 15.1" keys, 19" Touch <sup>1)</sup> , Flat Panel <sup>1)</sup> 12", 15", 17", 19"	
Pro Face Industrial PC: ALP 3600, ALP 3700, ALP 3900	

The mounting set can only be installed vertically.

<sup>1)</sup> 2 packs are required.

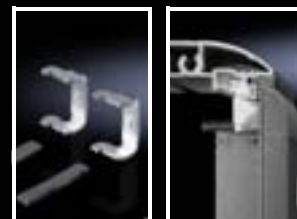

## Mounting kit

### for Comfort Panel

For the installation of aluminium front panels,  
command panels and keyboards.

#### Supply includes:

CP 6058.800, CP 6053.800:  
20 each of retaining claws, captive nuts, screws,  
nuts and sealing washers.

CP 6053.300:

8 medium retaining claws, 8 short retaining claws,  
4 long retaining claws

**1** 6058.800, 6053.800

**2** 6053.300

### For drilled holes/bolts/front panel mounting from behind

Thread	Model No. CP
M4	6058.800
M5	6053.800

### For screw clamp

For installing	Model No. CP
Siemens Sinumerik: OP 010, OP 010 C, OP 012, TP 012, OP 015, OP 015 A, MCP 483 C, MCP 483, PP 012, PP 012 extension, MCP, KB 483 C, Querty 19"	6053.300
Siemens Simatic: Panel PC 477, 577, 677, 677B: 12.1" keys, 12.1" Touch, 15.1" keys, 15.1" Touch, 19" Touch	
Panel PC 877: 12.1" keys, 15.1" keys, 15.1" Touch, 19" Touch, TP 277 6" MP 377 15" Touch, MP 377 12" Touch, MP 377 19" Touch	
B & R: Automation Panel Panel PC	



# Monitors



## TFT monitor

Installation variant for surfaces and command panels.

### Benefits:

- High-quality industrial design
  - Reduced installation work thanks to integral front frame
  - No additional ventilation required
  - Very small installation depth (45 mm)
- Resistive touchscreen for operation with a pen, finger or glove.

### Material:

Front frame: Aluminium

### Surface finish:

Powder-coated

### Colour:

RAL 7035

### Protection category:

IP 65 to IEC 60 529 (front)

### Supply includes:

Seal, hex nuts (for installation in surfaces), VGA cables, rear threaded bolts M5 (14). Touch variants additionally with integral connection cable and driver CD-ROM.

Size	Width mm	Height mm	Model No. SM	
			Touch	
			Without <sup>1)</sup>	resistive, USB
15"	430	343	<b>6450.010</b>	<b>6450.070</b>
17"	482.6	354.8	<b>6450.020</b>	–
19"	482.6	399.3	<b>6450.170</b>	–

<sup>1)</sup>With anti-reflection coated safety glass screen.

### Note:

Other variants as resistive touchscreen with serial or USB interface available on request.



### Also required:

Mounting kit CP 6053.800 (when installing in Comfort Panel), see page 605.  
Mounting kit CP 6053.500 (when installing in VIP 6000 and Optipanel), see page 605.  
Power pack SM 6450.050, see page 606 and connection cable SM 6450.060, see page 606, if an operating voltage of only 100 – 240 V AC is available instead of 12 V DC.

### Detailed drawings:

Available on the Internet.

Technical specifications	15"	17"	19"
Resolution of display (max. pixels)	1024 x 768	1280 x 1024	1280 x 1024
Resolution of controller/colours	VGA-SXGA/16.2 million		
Brightness (cd/m <sup>2</sup> )	400	300	250
Contrast ratio	500 : 1		
Reading angle horizontal (right/left)	65°/65°	75°/75°	88°/88°
Reading angle vertical (top/bottom)	45°/65°	65°/65°	88°/88°
Lamp life <sup>1)</sup> (h)	min. 35.000	typ. 50.000	min. 40.000
On-screen display (OSD)	At rear		
VGA input/DVI-D	D-Sub HD 15-pole	DVI-D jack	
Operating temperature (°C)/storage temperature (°C)	0 to +50/-20 to +60		
Voltage input	12 V DC		
Power consumption (W)	30	35	40
H-Sync. (kHz)/V-sync. (Hz)	31.5 to 80/60 to 75		
Humidity in operation (%)	20 to 80 (non-condensing)		
Humidity in storage (%)	5 to 95 (non-condensing)		

<sup>1)</sup>Until half the original brightness is reached.



## Power pack

### For TFT monitor

- With IEC 320 socket,
  - With connection cable (1.5 m) and connector for connecting to the TFT monitor.
- Dimensions, W x H x D: 107 x 30 x 59 mm.

### Technical specifications:

- Input voltage: 100 – 240 V AC
- Output voltage: 12 V DC
- Operating temperature: 10°C – 40°C

Packs of	Model No. SM
1	<b>6450.050</b>

### Material:

Enclosure: Plastic



## Connection cable

### for power pack

With IEC connector at one end.  
Length: 1.5 m.

Packs of	Model No. SM
1	<b>6450.060</b>

## TFT holder

Suitable for mounting TFTs with VESA 75/100 adaptation up to 21" on

- Housing coupling CP-S, CP 6501.050, see page 129
- CP-L enclosure attachment □ 120 x 65 mm, CP 6525.610, see page 133
- Vertical support arm via enclosure attachment, tilting CP 6902.670, see page 129

**Material:**

Sheet steel

**Surface finish:**

Spray-finished

**Colour:**

RAL 7024

Dimensions mm	Packs of	Model No. SM
477 x 372 x 110.5	1	2383.030

**Detailed drawings:**

Available on the Internet.



## TFT holder

### Vertically hinged

Suitable for mounting TFTs with VESA 75/100 adaptation up to 20.1" on

- PC enclosures
- Other enclosures based on TS

The TFT support is attached to the upper horizontal enclosure section using appropriately fitted bars and/or punched sections.

The integral swing mechanism allows the TFT to be swung forwards out of the enclosure while operational, to provide access to the equipment behind it. The display on the TFT remains visible even after it has been swung forwards. The length of the actuator handle is adjustable to adapt to the size of the TFT.

**Material:**

Sheet steel

**Supply includes:**

Assembly parts.

Packs of	Model No. SM
1	2383.040



**Also required:**

For enclosure depth mm	Punched rail TS 18 x 38 mm	Page
400	8612.240	462
500	8612.250	462
600	8612.260	462
800	8612.280	462

**Detailed drawings:**

Available on the Internet.



# Keyboards, supports and drawers



## Keyboard, pull-out with integral trackball

Super-slimline keyboard with cursor keys and trackball. The handle also serves as a hand rest. The 10° angled pullout ensures ergonomic working.

For installation in:

- Any sufficiently large surface (e.g. door, side panel)
- Front panels
- Directly in Comfort Panel and Optipanel of a suitable size, selectable via configurators – see [www.rittal.com](http://www.rittal.com)

### Material:

Sheet steel

### Surface finish:

Front panel: Powder-coated

### Colour:

RAL 7035

### Technical specifications:

Keyboard:

- 84 short-stroke keys, IBM-AT compatible (MF2), incl. cursor keys
- With integral 16 mm trackball
- Interface: 2 x 6-pole PS/2 DIN connector
- Operating temperature: +5°C to +50°C
- Storage temperature: -10°C to +60°C
- Humidity: max. 95% (non-condensing)

Keyboard layout	Packs of	Model No. SM
German	1	6002.100

### Protection category:

IP 65 (front, solid) to IEC 60 529

### SM 6002.100

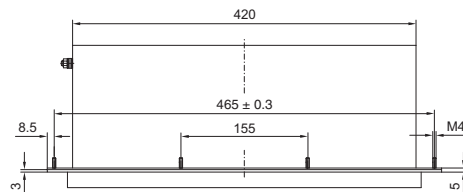
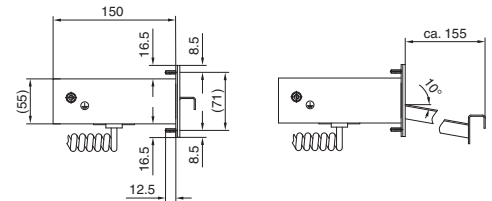
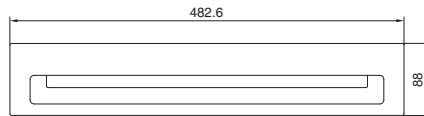

### Mounting cut-out

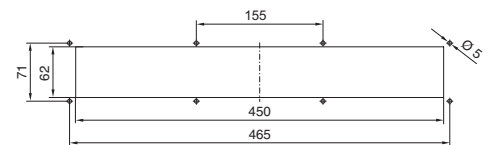



# Keyboards, supports and drawers

## Built-in keyboard 19" 4 U

### with integrated touchpad

The integral touchpad means that the installation of an additional, correct protection category mouse is no longer required, and cabling is also reduced. The short stroke keys are easily identified by edge embossing, less force is required to operate them and they have good positive key actuation.

#### Benefits:

- The separate number pad enables the parameters to be entered quickly
- Sealed, wipeable surface finish
- High level of mechanical and chemical resistance as per DIN 42 115.

#### Technical specifications:

- Number of keys: 105
- Front panel dimensions: 482.6 x 177.0 mm (482.6 mm (19") x 4 U)
- Installation depth: 23 mm
- 12 M5 x 20 threaded bolts at back
- Actuation travel/force: 0.3 mm/2.6 N
- Service life: 3 million switching cycles
- Operating temperature: -40°C to +90°C
- Touchpad resolution, capacitive: 40 pixels/mm
- Interfaces: 2 x PS/2 (1 USB adaptor supplied loose)

#### Material:

Front panel: Aluminium

#### Protection category:

IP 65 to IEC 60 529 (front)

#### Supply includes:

- Y connection cable, length 1.8 m
- PS/2 connector
- USB adaptor
- Seal
- Drilling template
- Assembly parts for surfaces

Keyboard layout	Packs of	Model No. SM
German	1	6446.020

#### ! Also required:

Mounting kit CP 6053.800 (when installing in Comfort Panel), see page 605.

Mounting kit CP 6053.500 (when installing in Optipanel), see page 605.

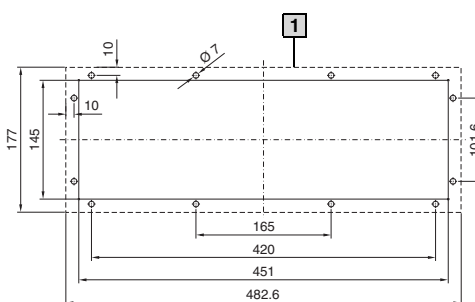

1 Contact surface



## Fold-out tray

### for keyboard and mouse

For installation in

- 600 and 800 mm wide doors
- 482.6 mm (19") swing frames and enclosures

Standard double-bit lock insert which may be exchanged for lock inserts 27 mm, version A, see page 421 and for lock cylinder SZ 2571.000, see page 422.

#### Material:

- Flap: Sheet steel
- Side parts: Cast aluminium
- Tray: Extruded aluminium section

#### Surface finish:

- Cover, side parts: Textured paint
- Tray: Natural-anodised

#### Colour:

Cover, side parts: RAL 7035

#### Protection category:

IP 55 to IEC 60 529

#### + Accessories:

Mousepad support, pull-out, see page 610.

Mounting cut-out

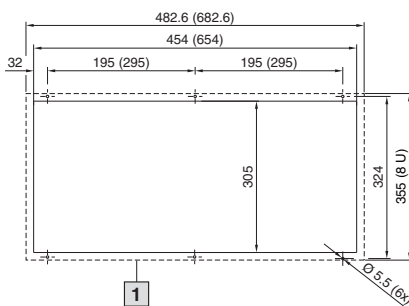

1 Contact surface



For door width mm	Dimensions W x H x D mm	Installation depth mm	Max. keyboard dimensions W x H x D mm	Model No. SZ
600	482.6 (19") x 355 (8 U) x 126	93	405 x 50 x 250 405 x 50 x 195 <sup>1)</sup>	2379.600
800	682.6 x 355 (8 U) x 126	93	605 x 50 x 250 605 x 50 x 195 <sup>1)</sup> 475 <sup>1)</sup> x 50 x 250	2379.800

<sup>1)</sup> Maximum keyboard size with holder for mouse.

# Keyboards, supports and drawers



## Support for mousepad, pull-out

### with mouse holder

For screw-fastening into the fold-out tray  
SZ 2379.600/SZ 2379.800, see page 609.  
To fit all standard mousepads up to 250 x 205 mm.

### Supply includes:

Assembly parts.

Packs of	Model No. SZ
1 set	2379.900



## Support

### for keyboards

for max. 473 x 210 mm.

Prepared for

- Cable gland
- Support for mousepad, vertically hinged (SM 2383.020)

### Material:

- Side parts: Sheet steel
- Front and rear: Extruded aluminium section

### Surface finish:

- Side parts: Textured paint
- Front and rear: Natural-anodised

### Colour:

Side parts: RAL 7024

### Supply includes:

2 clamping screws, end stoppers, cover plate, cable entry grommet and nylon loop tape.

Packs of	Model No. SM
1 set	2383.000



### Also required:

For external mounting on surfaces using enclosure surface connectors, see page 603.



### Accessories:

Mousepad support, swivelling, see page 615.



## Utility bars, vertically hinged

To support standard keyboards during programming and servicing work.

Mounting distance of utility bars for problem-free insertion at least 300 mm.

Depth adequate for keyboards up to max. 210 mm.

For mounting beneath:

- Comfort Panel<sup>1)</sup>
- Optipanel<sup>2)</sup>
- Any sufficiently large surface, such as:
  - Worktops IW
  - Operating housing
  - Command panel housing with door

on:

- Vertical services (doors/side panels)

Min. front panel width

<sup>1)</sup> 385 mm

<sup>2)</sup> 405 mm

After use, the utility bars fit securely and neatly under the mounting surface, thus giving the operator more space to move around.

Packs of	Model No. CP
1 set	6514.200

### Material:

Sheet steel

### Surface finish:

Zinc-plated

### Supply includes:

Assembly parts.



# Keyboards, supports and drawers

## Keyboard rack, 482.6 mm (19")

- 19" rack-mounted chassis 1 U, 430 mm deep
- Prepared for the installation of 482.6 mm (19") keyboards with touchpad or trackball and mouse with the following dimensions:  
max. height: 39 mm,  
max. width: 417 mm,  
max. depth: 210 mm
- Solid, lockable front
- Telescopic slides with integral clamp
- Prepared for installation of a mousepad

**Material:**  
Sheet steel

Design	Packs of	Model No. RP
PS/2	1	3659.520
USB	1	3659.680

**Colour:**  
RAL 7035

- Supply includes:**
- 482.6 mm (19") chassis **excluding keyboard**,
  - Connection cable,
  - Mounting bracket for 800 and 900 mm enclosure depth,
  - Assembly parts.



## Mousepad

### for keyboard rack

- For optional mounting on the left, right or front of the keyboard rack (fold-away design)
- Maybe folded into the keyboard drawer after use
- Only suitable for use in conjunction with 482.6 mm (19") keyboards with a total height of max. 39 mm (Model No. RP 9911.396)

**Material:**  
Sheet steel

Assembly	Packs of	Model No. RP
right/left	1	3659.620

**Colour:**  
RAL 7035

- Supply includes:**  
Assembly parts.



## Keyboard, 482.6 mm (19")

### with PS/2 connections

- 482.6 mm (19") keyboard for installation in the 482.6 mm (19") keyboard rack in conjunction with the mousepad
- German keyboard layout
- 36/38.9 mm high keys facilitate installation in 1 U keyboard drawers
- PS/2 connector
- 105 keys (including WIN 95 keys)
- Operating temperature: 0°C to +50°C

W x H x D mm	Design	Packs of	Model No. RP
403 x 36 x 171	German	1	9911.396

**Protection category:**  
IP 20

- Supply includes:**  
Connection cable.



## TFT display, 15"

- 482.6 mm (19") front panel, 7 U
- TFT LCD 15.1"
- Anti-reflection coated safety glass screen
- Brightness: 250 cd/m<sup>2</sup>
- On-screen display
- Colours: 16.7 million
- Power pack: Input voltage: 100 – 240 V AC, output: 12 V DC/3.75 A
- OSD membrane keyboard
- VGA + SVGA, non-interlaced
- Maximum resolution 1024 x 768 pixels
- Contrast ratio: 300 : 1
- Viewing angle: 160° (H+V)
- Video input 15-pin D-SUB (analog RGB)
- RS232 monitor interface

Packs of	Model No. RP
1	3659.440

**Material:**  
Front panel: Aluminium, powder-coated

**Colour:**  
RAL 7035

**Protection category:**  
Tested to EN 60 950 and EMC directive 89/336/EEC.

**Note:**  
Depth varies according to the display design (protective glass, touchscreen etc.).

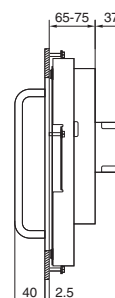
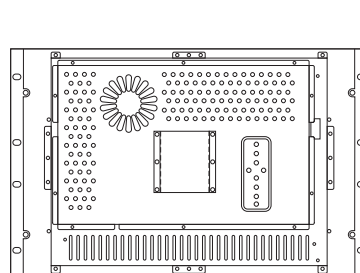
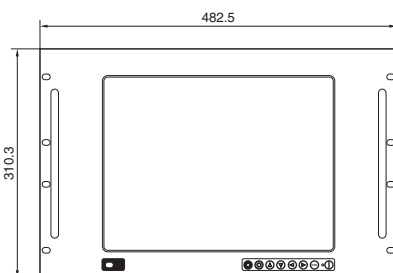

# Keyboards, supports and drawers



## Drawer 482.6 mm (19 1/2 U) for keyboard and mouse

For installation in:

- Any sufficiently large surface (e.g. door, side panel)
- 482.6 mm (19") system punchings
- Front panels
- Directly in Comfort-Panel and Optipanel of a suitable size, selectable via configurators – see [www.rittal.com](http://www.rittal.com)

Suitable for

- Accommodation of keyboards up to max. 390 x 32 x 139 mm.
- Support of standard commercially available mouse or trackball.

### Design:

- Drawer: With stay
- Front panel: With security lock (lock no. 12321) and handle strip

Width mm	U	Depth mm	Model No. CP
482.6 (19")	2	150	6002.000

### Material:

- Drawer housing: Sheet steel
- Drawer and front panel: Aluminium

### Surface finish:

- Drawer housing: Zinc-plated
- Drawer and front panel: Natural-anodised

### Supply includes:

Assembly parts for installation in Comfort Panel/ Optipanel command panel.

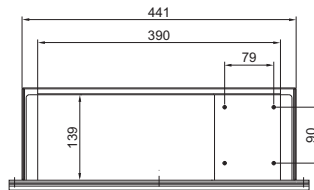
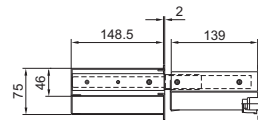
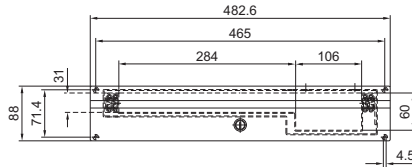

Mounting cut-out  
(for installation in surfaces)

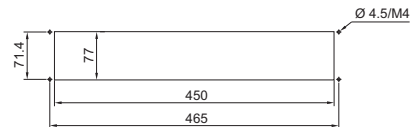

# Keyboards, supports and drawers

## Drawer for keyboard and mouse

### with mousepad support

For installation in:

- Any sufficiently large surface (e.g. door, side panel)
- 482.6 mm (19") system punchings
- Front panels

Suitable for accommodating

- Keyboards up to a maximum of 460 x 42 x 170 mm.
- Standard mouse and mousepad.

### Design:

- Drawer and enclosure: With side pull-out mousepad support and tray
- Front panel: With 3 mm double-bit lock insert, folds out as handrest

Width mm	U	Depth mm	Model No. CP
482.6 (19")	3.5	261	6003.000

### Material:

- Drawer and enclosure: Sheet steel
- Front panel: Aluminium

### Surface finish:

- Drawer and enclosure: Textured paint
- Front panel: Natural-anodised

### Supply includes:

Assembly parts.

### + Accessories:

Standard double-bit lock insert may be exchanged for 27 mm lock inserts, version A, see page 421.

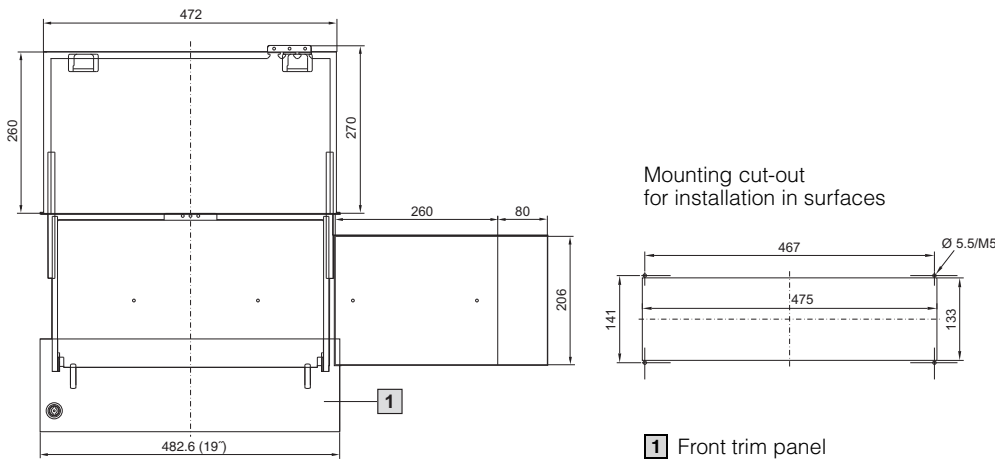

## Keyboard drawer 1 U

### for 482.6 mm (19") attachment level

This space-saving keyboard drawer is screw-fastened to the front and rear 482.6 mm (19") attachment level.

The installation spacing is infinitely adjustable from 460 – 800 mm.

It is fully extendible, lockable, with strain relief and hinged cable support.

The drawer is suitable to accommodate 482.6 mm (19") keyboards.

### Interior dimensions:

W x H x D approx. 420 x 40 x 220 mm

### Material:

Sheet steel

### Colour:

RAL 7035

### Supply includes:

Assembly parts, excluding keyboard.

### Note:

Monitor/keyboard unit, 1 U, see page 590.

Distance between levels mm	Model No. DK
460 – 800	7281.200 <sup>1)</sup>

<sup>1)</sup> Delivered without keyboard.



# Keyboards, supports and drawers

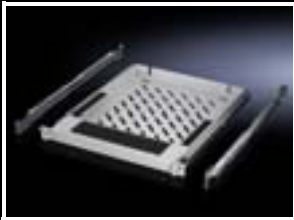
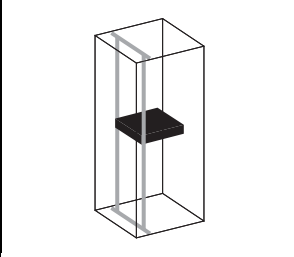

## Keyboard drawer 2 U

### for a 482.6 mm (19") mounting level

For keyboards up to 430 mm wide and 250 mm deep with the front panel folded over.

#### Material:

Sheet steel with aluminium front

#### Surface finish:

Spray-finished

#### Colour:

RAL 7035

#### Supply includes:

- Lockable drawer with handles,
- Folding front,
- Pull-out mousepad,
- Mouse support,
- Practical cable entry
- and strain relief.

Height	Packs of	Model No. DK
2 U	1	7281.035

Installation depth: 390 mm.

## Drawer 482.6 mm (19")

### for keyboard

For attaching to the 482.6 mm (19") mounting angles front and rear. Suitable for standard keyboards > 482.6 mm (19"). Keyboard support with non-slip base, plus wrist support. Depth-variable installation from 610 – 950 mm. Clearance opening W x H x D: 408 x 40 x 550 mm.

#### Material:

Sheet steel

#### Colour:

RAL 7035

#### Supply includes:

Assembly parts, excluding keyboard.

Packs of	Model No. DK
1	7063.888

#### Note:

Installation only possible on L-shaped and cranked 482.6 mm (19") mounting angles and/or 482.6 mm (19") mounting frames.

## Support for mousepad

### for command panels and surfaces

The angle of the mousepad support is individually adjustable.

Two holes are needed on the enclosure for attachment purposes.

#### Material:

Sheet steel

#### Surface finish:

Zinc-plated

#### Supply includes:

Assembly parts.

Weight kg	Packs of	Model No. SM
1.0	1	2381.000



#### Accessories:

Holder for mouse, see page 615.

# Keyboards, supports and drawers

## Support for mousepad, vertically hinged

For mounting on the left/right, beneath support for keyboards. Latches home automatically, both when retracted and extended. With mounting holes for mouse holder (SM 2382.000). With cutouts for cable routing and holes for attachment via cable ties, for fast assembly (SZ 2597.000).

**Material:**  
Sheet steel

**Surface finish:**  
Zinc-plated

**Supply includes:**  
Assembly parts and mousepad, stuck on with adhesive.

Packs of	<b>Model No. SM</b>
1	<b>2383.020</b>

### + Accessories:

Holder for mouse, see page 615.  
Cable ties, see page 530.

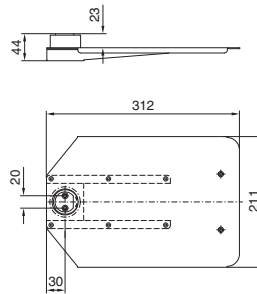

## Holder for mouse

To fit mousepad support and for secure accommodation of a standard mouse.

**Material:**  
Sheet steel

**Surface finish:**  
Zinc-plated

**Supply includes:**  
Assembly parts.

Weight kg	Packs of	<b>Model No. SM</b>
0.3	1	<b>2382.000</b>

### ! Also required:

Support for mousepad, see page 614.



## Paper removal flap

### For installation in surfaces

Facilitates easy removal of pages from the printer without opening the enclosure door. Plexiglass flap with magnetic lock.

Paper removal flap	Colour RAL	Packs of	<b>Model No. IW</b>
DIN A4	7015	1	<b>6903.200</b>



# Interfaces

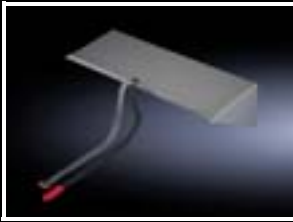

## Base

### for tubular door frame

The space-saving alternative instead of component shelves to accommodate tower PCs (maximum 20 kg).

For screw-fastening to the tubular door frame of 600 mm wide enclosures based on TS.

Load capacity: 20 kg.

**Material:**  
Sheet steel

**Surface finish:**  
Spray-finished

**Colour:**  
RAL 7015

**Supply includes:**  
Retaining strap and assembly parts.

Width x height x depth mm	Packs of	Model No. IW
495 x 159 x 230	1	6902.950



### Also required:

TS support strips for direct screw-fastening to the tubular door frame, see page 462.



## Interface box

For secure accommodation for all common computer ports, 3 1/2" disk drives and sockets. The lockable metal cover provides a high mechanical load-bearing capacity, protects against unauthorised access and ensures an increased shielding effect for the installed equipment.

**Material:**  
– Front panel: Extruded aluminium section  
– Mounting tray: Aluminium, 1.5 mm  
– Flap: Aluminium, 3.0 mm

**Surface finish:**  
– Front panel: Powder-coated  
– Mounting tray: Powder-coated  
– Flap: Natural-anodised

Weight kg	Packs of	Model No. SZ
0.8	1	2482.000

**Colour:**  
RAL 7035

**Supply includes:**  
– Frame with hinged flap  
– Cam with security lock (No. 12321)  
– Mounting tray including seal and assembly parts



## Interface extension with wall connection and built-in RJ 45 module

For extending the internal enclosure interfaces – e.g. from industrial PCs and switches – up to the outside of the enclosure. The wall connection only needs the same space as a switch.

### Benefits:

- Rapid access for maintenance work
- The protection category of the enclosure is preserved
- The lock nut cuts automatically into the spray-finish or eloxal layer, thereby creating a conductive connection
- Captive protective cap

**Material:**  
– Enclosure: Brass  
– Cover: Aluminium  
– Seal: Polyamide

**Surface finish:**  
– Enclosure: Nickel-plated  
– Cover: Natural-anodised

**Protection category:**  
IP 66/67 to IEC 60 529  
(with the protective cap closed)

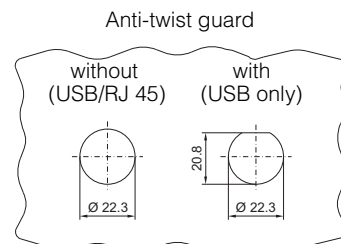

Material thickness: 1 – 6 mm



Design	Wall connection	Inside	Length m	Packs of	Model No. SZ
USB	Type A jack	Type A connector	0.5	1	2482.210
			1.0	1	2482.220
			2.0	1	2482.230
RJ 45	Jack	Connector	0.5	1	2482.700
			1.0	1	2482.710
			2.0	1	2482.720
RJ 45	Jack	Jack	–	1	2482.730



## Interface flaps, modular

For universal use in all situations where rapid access to interfaces and sockets is needed. The affected enclosure remains closed and is therefore protected from ambient influences and unauthorised access.

Space-saving installation e.g.

- in **small enclosures and compact enclosures** as a programming interface for controllers
- in **IT and industrial enclosures** as maintenance access for networks
- in **PC enclosures and console systems** for the temporary connection of additional equipment
- in mobile **Industrial Workstations** for rapid connection to existing network structures
- in **Command Panel systems** for programming and maintenance of integral components.

The mounting frame has a flap which snaps into position in various stages at opening angles of 90 to 180°. A snap fastener ensures a reliable seal. This may be locked if required.

### Material:

- Mounting frame and metal flap: Fine die-cast zinc
- Plastic flap: Polycarbonate (semi-transparent)
- Lock: Polycarbonate, RAL 7024

### Surface finish:

Mounting frame and metal flap: Matt nickel-plated

### Colour:

Lock: RAL 7024

### Protection category:

IP 65 to IEC 60 529 with sealed flap and proper assembly.

Description	cUL	UL	Packs of	Model No. SZ
<b>Mounting frame<sup>1)</sup></b>				
<b>1</b> Single, with plastic flap (semi-transparent)			1	<b>2482.300</b>
Double, with plastic flap (semi-transparent)			1	<b>2482.310</b>
<b>2</b> Single, with metal flap	■	■	1	<b>2482.320</b>
<b>3</b> Double, with metal flap	■	■	1	<b>2482.330</b>
<b>Socket modules</b>				
<b>4</b> Germany (VDE), spring-action terminals max. 2 x 2.5 mm <sup>2</sup> , connection at rear			1	<b>2482.400<sup>3)</sup></b>
<b>5</b> Germany (VDE), screw terminals max. 6 mm <sup>2</sup> , connection at rear, colour: yellow (RAL 1016), for installation in front of main switch			1	<b>2482.410<sup>3)</sup></b>
<b>Interface inserts</b>				
<b>6</b> 2 x SUB-D9 (jack/pin)	■	■	1	<b>2482.500</b>
<b>7</b> SUB-D9 (jack/jack)	■	■	1	<b>2482.510</b>
<b>8</b> 2 x USB A (jack/jack)	■	■	1	<b>2482.540<sup>2)</sup></b>
<b>9</b> RJ 45 (jack/jack, Cat. 5e), SUB-D9 (jack/jack), SUB-D9 (pin/pin)	■	■	1	<b>2482.550</b>
<b>10</b> 2 x RJ 45 (jack/jack, Cat. 5e)	■	■	1	<b>2482.560<sup>2)</sup></b>
<b>11</b> USB A (jack/jack), RJ 45 (jack/jack, Cat. 5e), SUB-D9 (jack/pin)	■	■	1	<b>2482.570<sup>2)</sup></b>
<b>12</b> Blanking plate (slimline), for individual population, usable area: 45 x 75 mm	■	■	1	<b>2482.590</b>

<sup>1)</sup> Electrically conductive.

<sup>2)</sup> Conductively linked to mounting frame.

<sup>3)</sup> Rated voltage: 250 V AC, rated current: 10 – 16 A

All SUB-D interfaces may be rotated while in use.

Other socket modules and interface inserts available on request.

### Interface flap, single

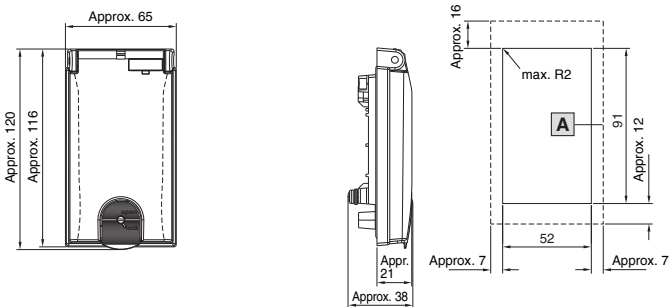

Permissible material thickness:  
1 – 5 mm

**A** Contact surface

### Interface flap, double

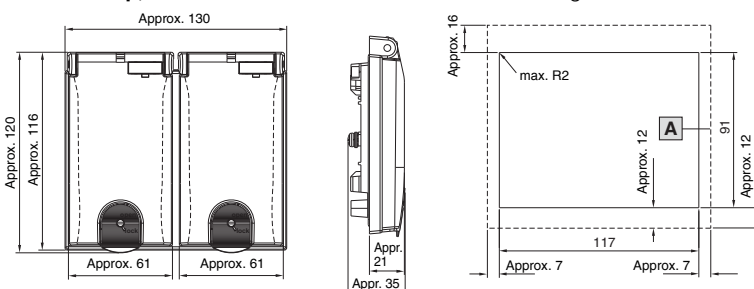

# Signal pillars



## Signal pillars, LED compact

### Benefits:

- Complete, ready-to-connect solution
- Minimal build height
- Extremely long service life of the LEDs (at least 70,000 h) – therefore maintenance-free
- Minimal assembly work and warehousing costs

### Technical specifications:

- Operating voltage: 24 V AC/DC
- Electrical connection: Screw terminals
- Light: LED
- Transmission angle: 3 x 120°
- Operating temperature: -20 to +70°C
- Flashing function: Controllable via PLC
- Cable entry: Metric screwed cable gland M12 x 1.5 for cable diameter 3.0 – 6.5 mm

### Protection category:

IP 65 to IEC 60 529

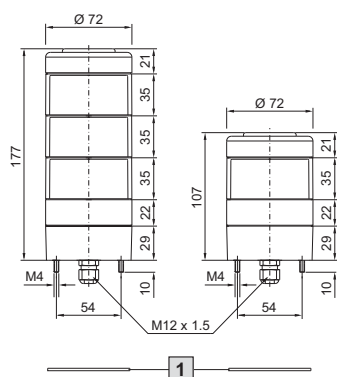

1 Seal

Design	Packs of	H mm	Model No. SG
3-stage, red, yellow, green	1	177	<b>2372.100</b>
1-stage, red	1	107	<b>2372.130</b>

### ! Also required:

- For wall mounting: Bracket for wall mounting, see page 622.
- For conduit mounting/support arm systems: Connection adaptor, see page 618.
- Other mounting components, see page 623/624.

Connection picture SG 2372.100/.130/.140

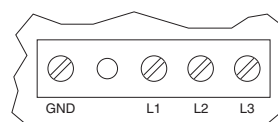

- GND – 0 V (Ground)  
 L1 – L3 – +24 V DC (LED light stages, from bottom to top, unneeded contacts are left free)

Mounting cut-out

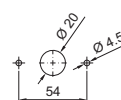

## Connection adaptors

### for signal pillar, LED compact

For conduit mounting and mounting on support arm systems.

### Material:

Plastic

### Colour:

Black

Packs of	Model No. SG
1	<b>2372.120</b>

### + Accessories:

- Mounting components for conduit mounting, see page 624.
- Mounting components for support arm system, see page 623.

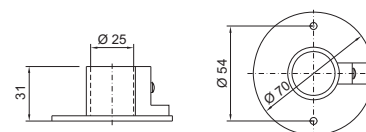

## Signal pillars, modular

### Benefits:

- Simple assembly and contact via bayonet fastener.
- Configuration of up to five components with the same voltage.
- Flashing and stroboscopic light element incl. lamp, suitable for direct use.
- Components are available in a range of colours and voltages.

For modular configuration of

- Connection components
- AS interface element
- Optical components
- Incandescent lamps/LED lamps
- Acoustic components
- Label panel



## Connection component

### for signal pillars, modular

Optionally for conduit or wall/base mounting. Screw terminals in the connection component. With cover for optical components. Contact hazard protection to VDE.

### Material:

Enclosure of polyamide

### Colour:

Black

### Protection category:

IP 54

Connection component	Model No. SG
For conduit mounting	<b>2368.000</b>
For wall/base mounting	<b>2368.010</b>



### Accessories:

- Mounting components for wall/base mounting, see page 622.
- Mounting components for conduit mounting, see page 624.
- Mounting components for support arm system, see page 623.



**Connection component for conduit mounting**  
SG 2368.000

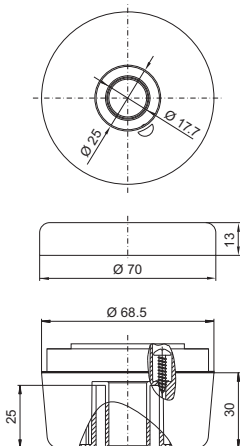

**Connection component for wall/base mounting**  
SG 2368.010

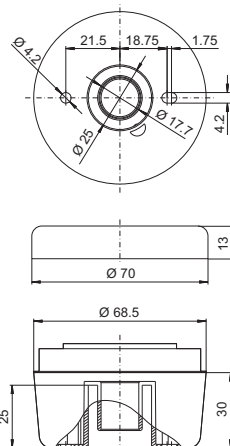

**1** Seal

Connection diagram

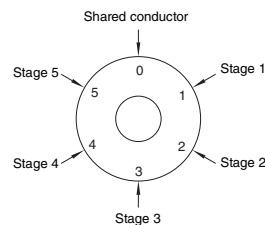

# Signal pillars

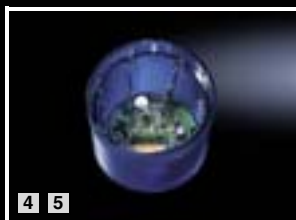
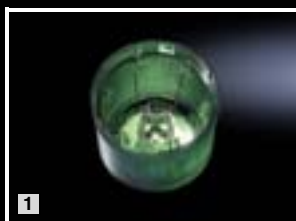

## Optical components

### for signal pillars, modular

With 360° signal transmission thanks to optimised prism system.

No. of potential stages = 5 components, with identical voltage.

#### Material:

- Enclosure: Polyamide
- Cap: Transparent polycarbonate

#### Protection category:

IP 54 if a cover or acoustic component is fitted at the top.

### ! Also required:

Incandescent lamps for steady light component, see page 620.

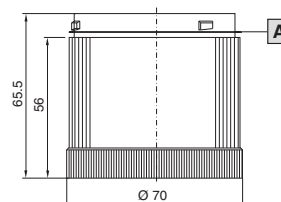

**A** Pre-configured seal

#### 1 Steady light component 12 – 240 V AC/DC<sup>1)</sup>

Model No. SG				
Red	Green	Yellow	Clear	Blue
2369.000	2369.010	2369.020	2369.030	2369.040

<sup>1)</sup> Incandescent lamps not included with the supply.

#### 2 LED steady light component 24 V AC/DC, 25 mA

Model No. SG				
Red	Green	Yellow	Clear	Blue
2372.000	2372.010	2372.020	2372.030	2372.040

#### 3 LED steady light component 230 V AC/DC

Model No. SG				
Red	Green	Yellow	Clear	Blue
2370.150	2370.160	2370.170	2370.180	2370.190

#### 4 LED flashing light component 24 V AC/DC

Model No. SG				
Red	Green	Yellow	Clear	Blue
2370.500	2370.510	2370.520	2370.530	2370.540

#### 5 LED flashing light component 230 V AC/DC

Model No. SG				
Red	Green	Yellow	Clear	Blue
2370.550	2370.560	2370.570	2370.580	2370.590

#### 6 Stroboscopic light component 24 V DC, 125 mA

Model No. SG				
Red	Green	Yellow	Clear	Blue
2371.000	2371.010	2371.020	2371.030	2371.040

#### 7 Stroboscopic light component 230 V DC, 15 mA

Model No. SG				
Red	Green	Yellow	Clear	Blue
2371.050	2371.060	2371.070	2371.080	2371.090

## Incandescent lamps

### for steady light components

With BA 15d base/plinth.

Incandescent lamp	Packs of	Model No. SG
24 V, 5 W	3	2374.060
230 V, 5 W	3	2374.070



# Signal pillars



## AS interface element for signal pillars, modular

User-friendly activation of the signal pillar levels via AS interface.

### Benefits:

- Standard slave.
- Max. 31 addresses.
- Up to 4 signal levels may be activated.
- Power supply may be switched from internal bus supply to external auxiliary voltage.
- With programming interface.
- Wiring and commissioning work is significantly reduced.
- For mounting directly on the connection component of the signal pillar.

Design	Packs of	Model No. SM
24 V DC	1	2376.100

Extended delivery times.

### Material:

Polycarbonate

### Colour:

Black, transparent

### Protection category:

IP 54 to IEC 60 529



### Also required:

Connection element, see page 619.

### Technical specifications:

Voltage supply		
AS interface element	Via bus cable	
Operating voltage	18.5 V DC to 31.6 V DC (to AS interface specification)	
Polarity reversal protection	Built-in	
Watchdog	Built-in	
External auxiliary voltage	24 V DC +/- 10%	
Auxiliary voltage	internal	external
Current carrying capacity max.	200 mA	200 mA per element
Current rating max.	250 mA	75 mA
Voltage on signal element	18 – 31 V DC	24 V DC +/- 10%
Short-circuit/overload protection	Built-in	Pre-fuse M 1.6 A
Temperature range	-20°C to +50°C	

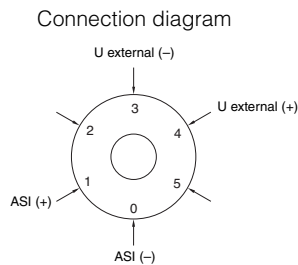
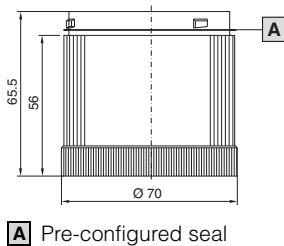

## Acoustic components

### for signal pillars, modular

To indicate warnings or malfunctions.

### Material:

Enclosure: Polyamide

### Colour:

Black

### Note:

Mounting only on the upper end of the optical components or directly on the connection component.

### 24 V AC/DC

Acoustic components	Packs of	Model No. SG
85 dB <sup>1)</sup> max. 25 mA	1	2376.000
100 dB <sup>2)</sup> max. 25 mA	1	2376.010

<sup>1)</sup> Continuous tone or pulsating

<sup>2)</sup> Volume and 8 tones may be set

### 230 V AC

Acoustic components	Packs of	Model No. SG
85 dB <sup>1)</sup> max. 25 mA	1	2376.020
100 dB <sup>2)</sup> max. 25 mA	1	2376.030

<sup>1)</sup> Continuous tone or pulsating

<sup>2)</sup> Volume and 8 tones may be set



# Signal pillars



## Label panel

### for signal pillars, modular

For text additions for up to 5 optical components, with break point for any fields that are not required (50 x 150 mm), including clamping section for base or tube with a diameter of 25 mm.

#### Material:

Acrylic, transparent

Label panel	<b>Model No. SG</b>
For 5 optical components	<b>2374.150</b>



## Mounting components

### for wall/base mounting

Fig.	Mounting component	Colour	Suitable for signal pillar		Model No. SG
			LED compact	modular	
<b>1</b>	Bracket for wall mounting, including rubber gland for concealed cable routing	Black	■		<b>2372.110</b>
<b>2</b>	Bracket for connection component	Black		■ <sup>1)</sup>	<b>2374.040</b>
<b>3</b>	For side cable outlet	Black		■ <sup>1)</sup>	<b>2374.080</b>



#### Also required:

<sup>1)</sup> Connection component SG 2368.010, see page 619.

### Bracket for wall mounting

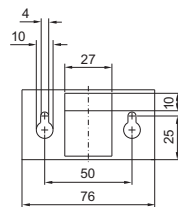
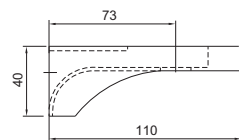

### Bracket for connection component

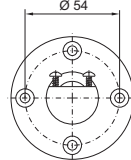
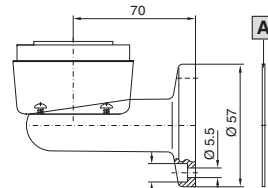

### For side cable outlet

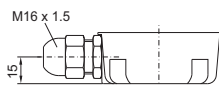
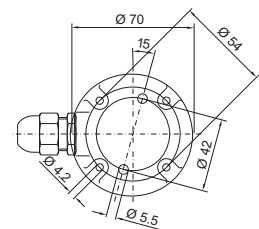

**A** Seal

**B** Flat seal

## Mounting components for support arm systems

Fig.	Mounting component	Colour	Suitable for signal pillar		Model No. SG
			LED compact	modular	
<b>4</b>	For support arm system CP-L – Angle piece CP 6524.0X0 – Angle coupling CP 6526.0X0	RAL 9017 (traffic black)	■ <sup>1)</sup>	■ <sup>2)</sup>	<b>2375.000</b>
<b>5</b>	For support arm system CP-L – Intermediate hinge CP 6523.0X0 – Wall-mounted hinge CP 6521.0X0 – Top-mounted joint CP 6522.0X0	RAL 9017 (traffic black)	■ <sup>1)</sup>	■ <sup>2)</sup>	<b>2375.020</b>
<b>6</b>	For support arm system CP-S – Angle piece 90° CP 6501.140	RAL 7024 (graphite grey)	■ <sup>1)</sup>	■ <sup>2)</sup>	<b>2375.030</b>
<b>7</b>	For support arm system CP-C – Angle coupling 90° CP 6071.200 – Angle piece 90° CP 6071.400 – Intermediate hinge CP 6071.800 – Wall-mounted hinge CP 6072.500 – Top-mounted joint CP 6072.600	RAL 7024 (graphite grey)	■ <sup>1)</sup>	■ <sup>2)</sup>	<b>6073.000</b>



### Also required:

- <sup>1)</sup> Connection adaptor SG 2372.120,  
see page 618.  
<sup>2)</sup> Connection component SG 2368.000,  
see page 619.



# Signal pillars

## Mounting components for conduit mounting

Fig.	Mounting component	Colour	Suitable for signal pillar		Model No. SG
			LED compact	modular	
8	Base with integral conduit, Ø 25 mm, 110 mm long	Black	■ <sup>1)</sup>	■ <sup>2)</sup>	2374.000
9	Individual base	Black	■	■	2374.010
10	Single conduit, 250 mm long	Aluminium	■ <sup>1)</sup>	■ <sup>2)</sup>	2374.020
	Single conduit, 400 mm long	Aluminium	■ <sup>1)</sup>	■ <sup>2)</sup>	2374.030
11	Angle bracket for conduit mounting	Black	■	■	2374.050
12	Base, tiltable from 0° – 90° in 7.5° increments. Simple cable entry up to a cable diameter of 14 mm.	Black	■ <sup>1)</sup>	■ <sup>2)</sup>	2374.090 <sup>3)</sup>

<sup>3)</sup> Extended delivery times.

### ! Also required:

<sup>1)</sup> Connection adaptor SG 2372.120, see page 618.

<sup>2)</sup> Connection component SG 2368.000, see page 619.



Base with integral conduit

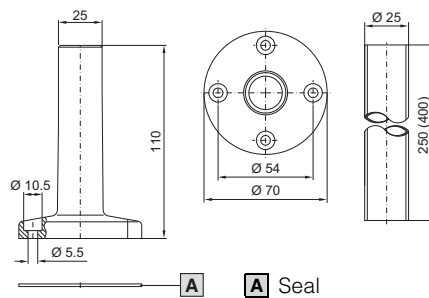

Single conduit

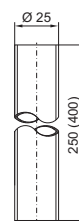

Individual base, plastic

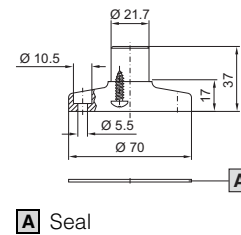

Angle bracket for conduit mounting

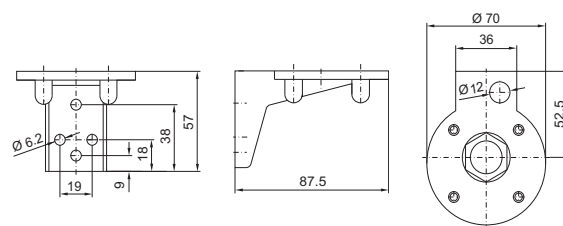

Base, tiltable

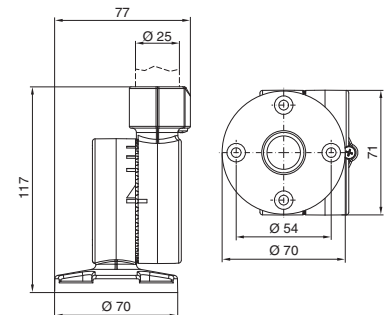



# List of model numbers

## 1001.600 to 2102.180

Model No.	Page	Model No.	Page	Model No.	Page	Model No.	Page
1001.600	162	1280.500	46	1526.010	161	1584.520	39
1002.500	162	1302.600	155	1527.010	161	1585.010	161
1002.600	162	1306.600	155	1528.010	161	1585.520	39
1003.600	162	1307.600	155	1528.510	34	1586.520	39
1004.600	162	1308.600	155	1529.010	161	1589.510	35
1005.500	163	1310.600	155	1529.510	35	1590.000	439
1005.600	163	1316.600	155	1530.010	161	1591.000	425
1006.500	163	1317.600	155	1530.510	35	1592.000	425
1006.600	163	1320.600	155	1531.510	35	1592.010	425
1007.600	163	1338.500	45	1532.510	35	1594.000	439
1008.600	163	1339.500	45	1533.510	36	1605.520	40
1009.600	163	1350.500	45	1535.510	35	1606.520	40
1010.500	163	1360.500	45	1536.510	35	1609.510	41
1010.600	163	1376.500	45	1537.510	36	1611.510	41
1011.600	162	1380.500	44	1539.510	35	1670.600	154
1012.600	163	1400.500	51	1548.500	37	1671.600	154
1013.600	163	1423.500	50	1549.500	37	1672.600	154
1014.600	164	1432.500	50	1550.500	37	1674.600	154
1015.600	163	1434.500	50	1553.500	37	1675.600	154
1016.600	164	1444.500	50	1554.500	37	1676.600	154
1017.600	164	1446.500	50	1555.500	37	1782.135	205
1018.600	164	1448.500	50	1556.500	37	1919.500	64
1019.500	164	1449.500	50	1557.500	37	1920.500	64
1019.600	164	1453.500	50	1558.010	161	1926.500	64
1030.500	44	1454.500	51	1558.510	40	1931.200	564
1031.500	44	1466.500	51	1559.010	161	1932.200	564
1032.500	44	1467.500	51	1559.510	40	1933.200	564
1033.500	44	1468.500	51	1560.700	443	1934.200	564
1034.500	44	1469.500	51	1561.700	443	1935.200	564
1035.500	44	1479.500	51	1562.700	443	1936.200	564
1038.500	45	1480.500	51	1563.700	443	1937.200	564
1039.500	45	1481.000	446	1564.700	443	1939.200	564
1045.500	45	1482.000	478	1565.700	443	1940.000	564
1050.500	45	1483.010	440	1567.700	443	1941.000	564
1054.500	45	1484.000	420	1568.700	443	1945.000	564
1055.500	46	1484.001	420	1569.700	443	1950.000	564
1057.500	45	1485.000	421	1571.700	443	1962.200	548
1058.500	45	1486.000	421	1575.700	443	1963.200	548
1060.500	45	1487.000	421	1576.700	443	1978.200	546
1073.500	46	1488.000	421	1577.450	40	1979.200	548
1076.500	45	1489.000	421	1577.500	38	1980.200	548
1077.500	46	1490.010	419	1577.520	40	1985.500	545
1090.500	45	1491.000	446	1577.530	40	1986.500	546
1100.500	46	1492.000	421	1577.550	40	1994.835	545
1101.110	165	1500.510	35	1577.560	40	1995.235	546
1101.120	165	1501.510	35	1578.450	41	1995.835	546
1101.130	165	1502.510	35	1578.500	38	1996.535	545
1101.140	165	1503.510	35	1578.520	41	1996.835	545
1101.800	429	1504.510	35	1578.530	41	1997.235	546
1101.910	406	1505.510	36	1578.550	41	1997.835	546
1101.920	406	1507.510	35	1578.560	41	2004.235	544
1101.930	406	1508.510	35	1579.450	41	2008.235	544
1101.940	406	1509.510	36	1579.500	38	2011.235	544
1110.500	46	1511.510	35	1579.520	41	2026.200	547
1114.500	46	1514.510	34	1579.530	41	2027.200	547
1130.500	46	1515.510	34	1579.550	41	2034.200	547
1158.500	517	1516.510	34	1579.560	41	2092.200	567
1180.500	46	1517.510	34	1580.000	439	2092.300	567
1199.100	400	1518.510	34	1581.000	514	2092.500	567
1213.500	46	1521.010	161	1581.100	516	2094.200	567
1228.010	368	1522.010	161	1582.000	514	2094.300	567
1228.110	368	1523.010	161	1583.010	161	2094.400	568
1228.310	368	1524.010	161	1583.520	39	2094.500	567
1260.500	46	1525.010	161	1584.010	161	2102.180	223

# List of model numbers

## 2102.190 to 2412.210

Model No.	Page	Model No.	Page	Model No.	Page	Model No.	Page
2102.190	223	2343.000	501	2372.100	618	2400.910	523
2102.320	223	2345.700	545	2372.110	622	2400.920	523
2102.400	223	2346.235	546	2372.120	618	2400.930	523
2102.410	223	2347.235	546	2372.130	618	2400.940	523
2102.490	223	2350.000	527	2373.000	476	2400.950	523
2203.400	530	2351.000	527	2373.210	459	2400.960	523
2231.000	564	2352.000	527	2373.250	459	2400.970	523
2232.000	564	2353.000	527	2373.300	459	2401.000	392
2233.000	564	2354.000	527	2373.350	459	2402.000	392
2235.135	518	2355.000	527	2374.000	624	2403.000	409
2237.000	467	2356.000	527	2374.010	624	2404.000	409
2238.000	467	2357.000	527	2374.020	624	2410.000	521
2239.000	467	2358.000	527	2374.030	624	2410.010	521
2243.605	62	2359.000	527	2374.040	622	2410.020	521
2246.605	62	2360.000	527	2374.050	624	2410.030	521
2249.605	62	2361.000	431	2374.060	620	2410.110	521
2252.605	62	2362.000	431	2374.070	620	2410.120	521
2253.605	63	2363.000	431	2374.080	622	2410.130	521
2255.605	62	2364.000	503	2374.090	624	2410.200	521
2256.605	63	2365.000	476	2374.150	622	2410.210	521
2258.605	62	2366.000	476	2375.000	623	2410.220	521
2259.605	63	2367.040	500	2375.020	623	2410.230	521
2261.605	62	2367.060	500	2375.030	623	2410.290	521
2262.605	63	2367.080	500	2376.000	621	2411.090	499
2265.605	63	2367.120	500	2376.010	621	2411.110	499
2268.605	63	2367.160	500	2376.020	621	2411.140	499
2271.605	63	2367.200	500	2376.030	621	2411.160	499
2304.000	421	2368.000	619	2376.100	621	2411.210	499
2304.010	156	2368.010	619	2377.030	543	2411.290	499
2305.000	409	2369.000	620	2377.060	543	2411.504	520
2307.000	421	2369.010	620	2377.090	543	2411.505	520
2308.000	424	2369.020	620	2377.120	543	2411.506	520
2309.000	467	2369.030	620	2377.150	543	2411.507	520
2310.038	427	2369.040	620	2377.180	543	2411.532	520
2310.076	427	2370.150	620	2377.460	543	2411.550	520
2310.100	427	2370.160	620	2377.860	543	2411.551	520
2310.120	427	2370.170	620	2377.880	543	2411.552	520
2311.225	426	2370.180	620	2379.600	609	2411.553	520
2311.250	426	2370.190	620	2379.800	609	2411.554	520
2313.150	467	2370.500	620	2379.900	610	2411.555	520
2313.750	467	2370.510	620	2381.000	614	2411.556	520
2314.000	467	2370.520	620	2382.000	615	2411.557	520
2315.000	467	2370.530	620	2383.000	610	2411.558	520
2316.000	467	2370.540	620	2383.010	603	2411.559	520
2317.000	467	2370.550	620	2383.020	615	2411.560	520
2318.000	467	2370.560	620	2383.030	607	2411.561	520
2319.000	467	2370.570	620	2383.040	607	2411.562	520
2322.700	545	2370.580	620	2384.010	160	2411.600	519
2323.235	546	2370.590	620	2384.020	160	2411.610	519
2324.235	546	2371.000	620	2384.030	160	2411.620	519
2325.000	426	2371.010	620	2384.040	160	2411.630	519
2326.000	426	2371.020	620	2388.000	498	2411.640	519
2327.000	426	2371.030	620	2388.100	498	2411.650	519
2328.000	426	2371.040	620	2388.120	498	2411.660	519
2331.700	545	2371.050	620	2388.150	498	2411.670	519
2332.235	546	2371.060	620	2388.200	498	2411.800	519
2334.000	501	2371.070	620	2388.280	498	2411.810	519
2335.000	501	2371.080	620	2388.600	498	2411.820	519
2336.700	545	2371.090	620	2388.800	498	2411.830	519
2337.235	546	2372.000	620	2389.000	601	2411.840	519
2338.235	546	2372.010	620	2400.000	522	2411.850	519
2340.700	545	2372.020	620	2400.300	524	2411.860	519
2341.235	546	2372.030	620	2400.500	524	2411.870	519
2342.235	546	2372.040	620	2400.900	523	2412.210	501

# List of model numbers

## 2412.216 to 2786.000

Model No.	Page	Model No.	Page	Model No.	Page	Model No.	Page
2412.216	501	2476.000	423	2515.000	428	2573.000	513
2412.225	501	2477.000	392	2518.000	429	2574.000	476
2412.310	501	2478.000	392	2519.000	429	2575.000	420
2412.316	501	2479.000	392	2519.200	429	2576.000	420
2412.325	501	2480.000	392	2520.000	421	2581.000	388
2413.375	499	2481.000	392	2521.000	424	2583.010	440
2413.550	499	2482.000	616	2522.000	421	2584.000	441
2414.000	500	2482.210	616	2523.000	421	2589.000	529
2414.500	500	2482.220	616	2525.000	422	2590.000	529
2415.000	500	2482.230	616	2526.000	421	2591.000	529
2415.100	430	2482.300	617	2527.000	421	2592.000	529
2415.500	447	2482.310	617	2528.000	421	2593.000	529
2416.000	423	2482.320	617	2530.000	421	2594.000	529
2418.000	423	2482.330	617	2531.000	424	2595.000	529
2419.000	423	2482.400	617	2532.000	424	2596.000	529
2420.000	421	2482.410	617	2533.000	420	2597.000	530
2422.000	438	2482.500	617	2534.100	422	2599.000	420
2423.000	438	2482.510	617	2534.500	422	2682.000	601
2424.100	432	2482.540	617	2535.000	420	2683.600	170
2425.100	432	2482.550	617	2536.000	420	2684.600	170
2426.100	432	2482.560	617	2537.000	418	2685.600	170
2426.500	432	2482.570	617	2537.010	418	2686.600	170
2427.100	432	2482.590	617	2540.500	421	2694.500	107
2430.000	421	2482.700	616	2541.235	298	2695.500	107
2432.000	425	2482.710	616	2542.235	298	2696.500	107
2433.000	439	2482.720	616	2543.235	298	2730.000	408
2433.500	439	2482.730	616	2545.000	424	2731.000	408
2435.000	419	2483.000	421	2546.000	424	2732.000	408
2436.732	388	2484.000	421	2547.000	424	2733.000	408
2436.735	388	2485.000	420	2548.000	424	2734.000	408
2437.000	388	2485.100	420	2549.000	424	2735.250	407
2438.735	388	2486.300	478	2549.500	424	2735.500	407
2439.000	420	2486.500	478	2549.510	156	2735.510	407
2440.735	388	2487.000	478	2549.600	156	2735.520	407
2446.000	427	2488.000	478	2559.000	501	2735.530	407
2449.000	425	2489.000	478	2560.010	514	2735.540	407
2450.000	419	2489.500	478	2560.400	517	2735.560	407
2450.010	419	2493.000	422	2561.010	514	2735.570	407
2451.000	419	2493.500	423	2561.100	516	2735.580	407
2452.000	419	2501.500	431	2561.400	517	2735.590	407
2453.000	419	2502.500	431	2561.500	515	2736.500	407
2454.000	419	2503.010	439	2562.010	514	2736.510	407
2455.000	419	2504.000	478	2562.100	516	2736.520	407
2455.010	419	2504.500	478	2562.400	517	2736.530	407
2456.500	419	2504.800	478	2562.500	515	2736.540	407
2459.000	384	2505.510	440	2563.010	514	2740.000	410
2459.500	384	2506.100	508	2563.100	516	2741.000	410
2460.000	421	2507.100	496	2563.150	517	2742.000	410
2460.650	421	2507.200	496	2563.500	515	2743.000	410
2461.000	421	2507.300	496	2564.000	501	2744.000	410
2462.000	421	2507.400	496	2565.000	501	2745.000	410
2463.000	421	2507.500	496	2565.100	501	2746.000	410
2464.000	421	2508.010	439	2565.110	501	2749.000	410
2465.000	421	2508.100	439	2565.120	501	2760.000	408
2466.000	421	2509.000	438	2566.000	501	2761.000	408
2467.000	416	2509.500	438	2567.000	501	2762.000	408
2468.000	416	2510.000	428	2568.000	501	2763.000	408
2469.000	416	2511.500	431	2569.000	501	2772.000	408
2470.000	431	2512.000	428	2570.000	501	2780.000	408
2471.000	431	2513.000	428	2570.100	503	2781.000	408
2472.000	431	2514.000	428	2570.200	501	2782.000	408
2473.000	431	2514.500	428	2570.500	502	2784.000	408
2474.000	431	2514.600	428	2571.000	422	2785.000	408
2475.000	431	2514.800	428	2572.000	420	2786.000	408

# List of model numbers

## 2787.000 to 3244.140

Model No.	Page	Model No.	Page	Model No.	Page	Model No.	Page
2787.000	408	2906.200	369	3159.100	347	3232.800	273
2788.000	408	2907.000	367	3164.115	220	3232.810	273
2789.000	408	2908.000	367	3164.230	220	3232.820	273
2791.000	410	2909.200	369	3164.610	220	3232.830	273
2792.000	410	2910.200	369	3164.620	220	3232.840	273
2793.560	409	2913.000	367	3165.024	225	3232.850	273
2796.000	408	3020.500	341	3165.048	225	3232.860	273
2801.200	369	3105.310	289	3165.115	225	3232.870	273
2802.200	369	3105.320	289	3165.230	225	3232.880	273
2804.200	369	3105.330	289	3165.615	225	3232.890	273
2805.200	369	3105.340	289	3165.624	225	3235.440	294
2807.200	369	3105.350	289	3165.630	225	3236.124	222
2808.200	369	3105.360	289	3165.648	225	3237.020	303
2816.200	369	3105.370	289	3165.815	225	3237.060	303
2817.000	364	3105.380	289	3165.824	225	3237.066	301
2818.200	369	3105.390	289	3165.830	225	3237.080	303
2819.000	364	3105.400	289	3165.848	225	3237.100	212
2819.200	364	3105.410	289	3169.007	220	3237.110	212
2823.200	369	3105.420	289	3171.100	301	3237.124	212
2824.200	369	3105.430	289	3172.100	301	3237.200	303
2826.200	369	3108.024	221	3173.100	301	3237.600	212
2828.200	369	3108.100	221	3174.000	301	3238.020	303
2829.200	369	3108.115	221	3175.000	304	3238.055	302
2830.200	369	3110.000	294	3176.000	304	3238.060	303
2836.200	369	3110.200	294	3177.000	299	3238.066	301
2837.200	369	3114.200	293	3181.100	302	3238.080	303
2839.200	369	3118.000	294	3182.100	302	3238.100	212
2840.200	369	3120.200	295	3183.100	302	3238.110	212
2843.160	499	3121.000	341	3201.040	302	3238.124	212
2843.200	499	3124.100	295	3201.050	301	3238.200	303
2843.250	499	3124.200	295	3201.070	295	3238.600	212
2843.320	499	3125.800	226	3201.200	232	3239.020	303
2843.400	499	3126.100	227	3201.300	232	3239.060	303
2843.500	499	3126.115	227	3201.900	304	3239.066	301
2843.630	499	3126.230	325	3201.910	304	3239.080	303
2855.000	370	3126.240	325	3209.100	252	3239.100	213
2856.000	370	3126.270	326	3209.104	253	3239.110	213
2859.000	374	3126.410	228	3209.500	252	3239.124	213
2860.000	370	3126.424	228	3209.504	253	3239.200	303
2865.000	370	3127.100	227	3210.100	253	3239.600	213
2866.000	370	3127.115	227	3210.104	254	3240.020	303
2867.000	370	3128.100	227	3210.140	253	3240.060	303
2868.000	370	3128.115	227	3210.500	253	3240.066	301
2869.000	370	3128.410	228	3210.504	254	3240.080	303
2870.000	370	3128.424	228	3210.540	253	3240.100	214
2875.000	370	3129.100	227	3212.024	255	3240.110	214
2876.000	370	3129.115	227	3212.115	255	3240.124	214
2878.000	370	3129.410	228	3212.230	255	3240.200	303
2879.000	370	3129.424	228	3213.310	293	3240.600	214
2880.000	370	3129.800	226	3213.320	293	3241.100	214
2885.000	370	3130.100	227	3213.330	293	3241.110	214
2886.000	370	3130.115	227	3214.100	255	3241.124	214
2887.000	370	3130.410	228	3215.100	255	3241.600	214
2889.000	371	3130.424	228	3216.480	258	3243.020	303
2890.000	371	3144.000	218	3232.700	272	3243.060	303
2891.000	364	3145.000	218	3232.710	272	3243.066	301
2892.000	364	3148.007	220	3232.720	272	3243.080	303
2899.200	524	3149.007	220	3232.730	272	3243.100	215
2899.250	524	3149.410	219	3232.740	272	3243.110	215
2899.320	524	3149.420	219	3232.750	272	3243.200	303
2899.400	524	3149.440	219	3232.760	272	3243.600	215
2903.200	369	3149.810	219	3232.770	272	3244.100	215
2904.200	369	3149.820	219	3232.780	272	3244.110	215
2905.200	369	3149.840	219	3232.790	272	3244.140	215

# List of model numbers

## 3244.600 to 3351.024

Model No.	Page	Model No.	Page	Model No.	Page	Model No.	Page
3244.600	215	3300.090	249	3301.967	305	3322.700	301
3245.080	303	3300.110	249	3302.100	234	3327.700	301
3245.500	216	3300.120	249	3302.110	234	3328.500	239
3245.510	216	3300.160	278	3302.200	234	3328.504	243
3245.600	216	3300.170	278	3302.210	234	3328.510	239
3248.000	229	3300.180	278	3302.300	233	3328.514	243
3253.000	299	3300.260	305	3302.310	233	3328.540	239
3253.010	299	3300.261	305	3303.500	235	3328.544	243
3253.200	300	3300.262	305	3303.504	242	3328.600	239
3253.220	300	3300.263	305	3303.510	235	3328.610	239
3254.000	299	3300.270	278	3303.514	242	3328.640	239
3254.200	300	3300.280	278	3303.530	243	3329.500	240
3267.100	299	3300.290	305	3303.600	235	3329.504	243
3267.200	300	3300.291	305	3303.610	235	3329.510	240
3273.500	246	3300.292	305	3304.500	237	3329.514	243
3273.515	246	3300.293	305	3304.504	242	3329.540	240
3284.200	300	3300.294	305	3304.510	237	3329.544	243
3284.210	300	3300.295	305	3304.514	242	3329.600	240
3285.000	299	3300.296	305	3304.530	243	3329.610	240
3285.200	300	3300.297	305	3304.540	237	3329.640	240
3286.000	299	3300.310	274	3304.544	242	3329.903	301
3286.100	299	3300.320	274	3304.560	243	3329.904	301
3286.110	299	3300.330	274	3304.600	237	3332.540	240
3286.120	300	3300.340	274	3304.610	237	3332.640	240
3286.200	300	3300.353	276	3304.640	237	3334.600	265
3286.210	300	3300.354	276	3305.500	238	3334.660	265
3286.230	300	3300.355	276	3305.504	242	3335.590	267
3286.240	300	3300.356	276	3305.510	238	3335.600	267
3286.250	300	3300.360	276	3305.514	242	3335.610	267
3286.260	297	3300.370	276	3305.530	243	3335.620	267
3286.270	297	3300.510	276	3305.540	238	3335.630	267
3286.280	297	3300.560	276	3305.544	242	3335.640	267
3286.300	299	3300.710	276	3305.560	243	3335.650	267
3286.310	300	3300.760	276	3305.600	238	3335.660	267
3286.400	299	3301.221	283	3305.610	238	3336.100	268
3286.410	300	3301.320	283	3305.640	238	3336.200	268
3286.500	299	3301.370	283	3307.700	248	3336.300	268
3286.510	300	3301.380	283	3307.710	248	3336.500	268
3286.520	300	3301.390	283	3307.740	248	3336.600	268
3286.530	300	3301.421	283	3310.700	248	3336.650	268
3286.540	300	3301.560	302	3310.710	248	3336.700	269
3286.550	300	3301.570	302	3310.740	248	3336.710	269
3286.600	299	3301.580	302	3311.010	279	3336.720	269
3286.610	300	3301.590	302	3311.020	280	3336.730	269
3286.700	297	3301.600	302	3311.030	283	3336.740	269
3286.780	292	3301.606	303	3311.040	283	3336.750	269
3286.800	297	3301.608	303	3311.050	283	3339.100	269
3286.850	292	3301.610	303	3311.060	283	3339.200	269
3286.860	292	3301.612	303	3311.110	279	3339.250	269
3286.870	291	3301.620	274	3311.130	279	3339.280	269
3286.880	292	3301.660	274	3311.210	280	3340.024	217
3286.900	297	3301.800	246	3311.230	279	3340.115	217
3286.970	291	3301.830	274	3311.260	279	3340.230	217
3286.980	292	3301.870	274	3311.310	283	3341.024	217
3286.990	291	3301.900	304	3311.400	281	3341.115	217
3288.200	300	3301.910	304	3311.530	280	3341.230	217
3289.200	300	3301.920	304	3311.560	280	3342.024	217
3294.100	299	3301.930	304	3311.600	282	3342.115	217
3294.200	300	3301.940	304	3318.600	264	3342.230	217
3300.040	249	3301.950	305	3318.610	264	3342.500	217
3300.050	249	3301.955	305	3319.600	264	3350.024	218
3300.060	249	3301.957	305	3319.610	264	3350.115	218
3300.070	249	3301.960	305	3320.600	265	3350.230	218
3300.080	249	3301.965	305	3321.700	301	3351.024	218

# List of model numbers

## 3351.115 to 4597.000

Model No.	Page	Model No.	Page	Model No.	Page	Model No.	Page
3351.115	218	3384.600	246	4140.220	493	4319.160	530
3351.230	218	3384.610	246	4140.810	494	4319.200	530
3352.024	218	3384.640	246	4140.820	494	4320.700	511
3352.115	218	3385.500	247	4140.830	494	4321.700	511
3352.230	218	3385.510	247	4140.840	494	4323.700	511
3352.500	218	3385.540	247	4155.000	492	4333.120	447
3355.100	218	3385.600	247	4155.100	492	4333.160	447
3356.100	218	3385.610	247	4155.500	492	4333.180	447
3357.100	218	3385.640	247	4156.000	425	4336.000	527
3359.500	245	3386.540	247	4157.000	477	4338.000	527
3359.510	245	3386.640	247	4162.000	477	4339.000	527
3359.540	245	3387.540	247	4163.000	477	4347.000	466
3359.600	245	3387.640	247	4164.000	477	4348.000	500
3359.610	245	3636.010	490	4165.000	477	4361.000	466
3359.640	245	3659.440	611	4166.000	477	4362.000	466
3360.100	266	3659.520	611	4169.000	463	4363.000	466
3360.250	266	3659.620	611	4170.000	463	4364.000	464
3360.470	266	3659.680	611	4171.000	463	4365.000	464
3361.500	236	3861.580	485	4172.000	463	4367.000	464
3361.510	236	4000.100	156	4173.000	463	4369.000	464
3361.540	236	4000.200	156	4174.000	463	4370.000	464
3361.600	236	4000.210	156	4175.000	463	4371.000	464
3361.610	236	4114.000	429	4176.000	463	4372.000	464
3361.640	236	4115.000	429	4177.000	463	4373.000	464
3363.100	256	4115.500	429	4178.000	463	4374.000	464
3363.104	259	4116.000	429	4179.000	477	4375.000	464
3363.500	256	4116.500	429	4180.000	477	4376.000	464
3363.504	259	4118.000	429	4181.000	473	4377.000	464
3364.100	256	4118.500	429	4182.000	472	4378.000	464
3364.104	259	4119.000	477	4183.000	473	4379.000	464
3364.500	256	4120.000	427	4189.000	425	4380.000	464
3364.504	259	4123.000	429	4190.000	425	4381.000	464
3366.500	241	4124.000	429	4191.000	527	4382.000	464
3366.510	241	4127.010	496	4192.000	527	4393.000	463
3366.540	241	4127.210	496	4193.000	527	4394.000	466
3366.600	241	4131.700	449	4196.000	527	4395.000	466
3366.610	241	4132.700	449	4198.000	438	4396.000	466
3366.640	241	4133.000	474	4199.000	474	4396.500	466
3373.100	257	4134.000	474	4309.000	462	4398.000	466
3373.104	260	4137.700	449	4311.000	512	4398.500	466
3373.500	257	4138.140	492	4315.100	496	4530.000	561
3373.504	260	4138.150	492	4315.150	496	4531.000	561
3374.100	257	4138.180	492	4315.200	496	4532.000	470
3374.104	260	4138.190	492	4315.320	496	4538.000	430
3374.500	257	4138.240	492	4315.350	496	4540.000	398
3374.504	260	4138.250	492	4315.400	496	4541.000	563
3375.100	258	4138.280	492	4315.450	496	4542.000	563
3375.104	261	4138.290	492	4315.520	496	4547.000	552
3375.500	258	4138.300	492	4315.550	496	4568.000	438
3375.504	261	4138.350	492	4315.600	496	4570.000	370
3377.000	297	4138.400	492	4315.710	496	4576.000	445
3382.500	244	4138.450	492	4315.720	496	4579.000	462
3382.510	244	4139.140	492	4315.800	495	4582.000	398
3382.600	244	4139.150	492	4315.810	495	4582.500	398
3382.610	244	4139.180	492	4315.820	495	4583.000	429
3383.500	245	4139.190	492	4315.830	495	4583.500	429
3383.510	245	4139.300	492	4315.840	495	4590.700	443
3383.540	245	4139.350	492	4315.850	495	4591.700	443
3383.600	245	4140.000	493	4315.860	495	4592.700	443
3383.610	245	4140.010	493	4316.000	512	4593.000	445
3383.640	245	4140.020	493	4317.000	512	4594.000	462
3384.500	246	4140.110	493	4318.000	512	4595.000	440
3384.510	246	4140.120	493	4319.090	530	4596.000	462
3384.540	246	4140.210	493	4319.120	530	4597.000	470

# List of model numbers

## 4598.000 to 6510.340

Model No.	Page	Model No.	Page	Model No.	Page	Model No.	Page
4598.000	462	5001.228	511	6070.200	137	6340.300	120
4599.000	462	5001.229	378	6071.000	142	6340.400	120
4611.000	374	5001.233	378	6071.200	137	6341.000	442
4612.000	373	5001.234	378	6071.400	137	6372.541	116
4638.600	427	5001.235	378	6071.600	143	6372.542	116
4638.800	427	5001.236	379	6071.800	137	6372.543	116
4650.000	171	5001.237	511	6072.000	137	6372.551	116
4694.000	462	5001.310	431	6072.200	137	6372.552	116
4695.000	462	5001.330	431	6072.400	137	6372.553	116
4696.000	462	5001.350	431	6072.500	137	6372.561	116
4697.000	462	5001.360	431	6072.600	137	6372.562	116
4757.500	107	5001.370	461	6072.800	137	6372.563	116
4911.000	393	5001.371	461	6073.000	623	6375.000	600
4911.100	393	5110.500	48	6074.000	137	6375.010	600
4912.000	393	5111.500	48	6074.100	137	6375.020	600
4916.000	393	5112.500	48	6074.300	137	6375.029	600
4918.000	393	5113.500	48	6074.500	137	6375.040	600
4920.000	393	5114.500	48	6075.100	137	6375.050	600
4933.000	467	5115.500	48	6075.300	137	6375.060	600
4934.000	467	5116.500	48	6075.500	137	6380.000	118
4935.000	467	5117.500	48	6100.000	141	6380.020	118
4937.000	467	5118.500	49	6100.500	141	6380.040	118
4943.000	465	5119.500	49	6107.000	602	6380.050	118
4944.000	465	5120.500	49	6107.100	602	6380.400	118
4945.000	465	5121.500	49	6107.200	602	6380.410	118
4946.000	465	5122.500	49	6108.000	478	6380.500	118
4947.000	465	5123.500	49	6110.010	141	6380.510	118
5001.000	425	6002.000	612	6110.100	141	6380.600	118
5001.050	459	6002.100	608	6120.010	141	6380.610	118
5001.051	459	6003.000	613	6130.010	141	6385.000	600
5001.052	459	6005.500	442	6130.510	141	6385.010	600
5001.053	459	6013.000	603	6130.610	141	6385.040	600
5001.054	459	6013.100	603	6135.000	148	6385.050	600
5001.060	416	6016.200	441	6136.000	148	6385.060	600
5001.061	416	6016.600	145	6136.500	148	6442.500	123
5001.062	416	6016.700	145	6137.035	147	6446.020	609
5001.070	446	6023.010	141	6137.535	147	6450.010	606
5001.075	447	6027.000	604	6140.010	141	6450.020	606
5001.080	527	6027.010	604	6141.100	148	6450.050	606
5001.081	527	6028.000	604	6141.200	148	6450.060	606
5001.082	527	6028.010	604	6143.200	147	6450.070	606
5001.083	527	6028.014	604	6143.210	151	6450.170	606
5001.130	381	6028.015	604	6143.310	151	6462.500	123
5001.140	381	6028.016	604	6144.100	151	6501.000	129
5001.150	381	6028.500	604	6146.100	147	6501.020	129
5001.160	381	6028.510	604	6146.200	147	6501.050	129
5001.210	378	6028.530	604	6146.300	147	6501.070	129
5001.211	378	6028.540	604	6146.400	147	6501.090	146
5001.212	378	6040.010	141	6147.000	151	6501.110	129
5001.213	378	6050.000	141	6148.000	374	6501.120	129
5001.214	378	6050.500	141	6160.010	141	6501.130	129
5001.215	378	6052.000	528	6170.010	141	6501.140	129
5001.216	378	6052.500	524	6180.010	141	6501.150	129
5001.217	378	6053.000	605	6190.000	601	6501.160	129
5001.218	378	6053.210	605	6200.000	141	6503.000	151
5001.219	378	6053.300	605	6200.500	141	6505.100	604
5001.220	378	6053.500	605	6205.000	143	6505.200	604
5001.221	378	6053.800	605	6205.100	470	6505.500	604
5001.222	379	6058.000	605	6214.000	150	6508.010	133
5001.223	379	6058.500	605	6214.500	149	6508.020	142
5001.224	379	6058.800	605	6215.000	149	6509.000	133
5001.225	379	6059.000	531	6220.000	150	6510.210	144
5001.226	511	6059.500	531	6340.000	120	6510.330	144
5001.227	511	6070.000	137	6340.100	120	6510.340	144

# List of model numbers

## 6511.000 to 7072.220

Model No.	Page	Model No.	Page	Model No.	Page	Model No.	Page
6511.000	133	6706.500	103	7000.510	86	7030.200	583
6513.000	133	6707.500	104	7000.520	87	7030.220	583
6513.050	133	6710.500	101	7000.530	87	7030.230	583
6514.200	610	6711.500	102	7000.532	87	7031.100	575
6515.000	133	6712.500	103	7000.560	86	7040.010	191
6519.000	145	6713.500	104	7000.570	86	7040.020	191
6520.010	133	6714.500	101	7000.580	87	7040.030	191
6520.510	133	6715.500	102	7000.590	87	7040.040	191
6521.010	133	6716.500	103	7000.592	87	7040.060	192
6522.010	133	6717.500	104	7000.620	483	7040.065	192
6523.010	133	6720.100	101	7000.625	486	7040.070	193
6524.010	133	6720.200	101	7000.630	506	7040.075	193
6524.210	133	6720.500	101	7000.640	400	7040.110	191
6525.010	133	6721.100	102	7000.652	388	7040.120	191
6525.110	133	6721.200	102	7000.653	388	7040.201	191
6525.210	133	6721.500	102	7000.663	388	7040.202	191
6525.510	133	6722.100	103	7000.670	224	7040.204	191
6525.610	133	6722.200	103	7000.672	375	7040.211	191
6526.010	133	6722.500	103	7000.675	503	7040.212	191
6527.010	133	6723.100	104	7000.676	460	7040.214	191
6527.110	133	6723.200	104	7000.678	460	7040.301	192
6528.010	142	6723.500	104	7000.680	224	7040.305	192
6528.110	146	6730.030	105	7000.684	204	7040.311	192
6528.210	143	6730.100	105	7000.685	536	7040.315	192
6528.410	144	6730.110	105	7000.840	85	7040.361	193
6528.450	142	6730.120	105	7000.850	85	7040.500	198
6528.510	142	6730.130	105	7000.852	85	7050.035	574
6529.010	133	6730.310	450	7000.875	95	7050.100	574
6530.200	122	6730.330	450	7000.882	95	7050.200	574
6531.200	122	6730.340	450	7000.885	95	7051.000	489
6532.200	122	6730.400	105	7000.892	95	7061.000	489
6533.200	122	6730.410	105	7000.895	95	7063.000	560
6534.000	121	6730.600	298	7000.940	88	7063.200	539
6535.000	121	6740.500	106	7000.944	88	7063.710	485
6535.010	167	6742.500	106	7000.990	568	7063.720	485
6536.000	121	6746.500	106	7016.100	542	7063.725	485
6536.010	167	6748.500	106	7016.110	542	7063.740	560
6537.000	121	6900.000	111	7016.120	542	7063.750	559
6538.000	121	6900.100	111	7016.130	542	7063.752	559
6538.010	167	6900.300	109	7016.140	532	7063.835	484
6539.010	167	6900.400	111	7016.150	532	7063.837	484
6540.200	122	6900.410	111	7030.000	582	7063.850	563
6544.000	121	6901.100	111	7030.010	582	7063.858	488
6552.500	123	6902.100	111	7030.030	580	7063.860	488
6660.010	169	6902.300	111	7030.040	581	7063.882	559
6660.050	169	6902.310	148	7030.050	581	7063.883	559
6662.500	123	6902.400	111	7030.060	584	7063.884	559
6663.000	169	6902.500	111	7030.070	585	7063.888	614
6663.400	169	6902.640	143	7030.071	585	7063.890	488
6663.500	169	6902.670	145	7030.080	584	7063.892	488
6664.000	169	6902.700	481	7030.090	584	7063.895	484
6664.100	169	6902.770	522	7030.091	584	7063.897	484
6664.300	169	6902.920	371	7030.092	584	7064.000	489
6664.500	169	6902.950	616	7030.093	584	7064.100	533
6665.000	169	6902.960	480	7030.094	584	7064.110	533
6665.500	169	6902.980	480	7030.095	584	7065.000	489
6680.000	166	6903.200	615	7030.100	583	7066.000	489
6681.000	166	7000.390	86	7030.110	583	7066.700	489
6700.500	101	7000.410	86	7030.111	583	7067.100	400
6701.500	102	7000.430	86	7030.120	583	7067.200	400
6702.500	103	7000.440	86	7030.130	583	7069.535	569
6703.500	104	7000.450	87	7030.140	583	7072.100	522
6704.500	101	7000.460	87	7030.150	583	7072.200	518
6705.500	102	7000.500	86	7030.190	583	7072.220	530



# List of model numbers

## 7072.230 to 7463.100

Model No.	Page	Model No.	Page	Model No.	Page	Model No.	Page
7072.230	530	7148.035	485	7240.190	506	7300.335	570
7072.240	530	7149.035	540	7240.200	505	7320.435	584
7077.000	529	7149.135	540	7240.201	505	7320.440	586
7078.000	529	7150.535	542	7240.205	505	7320.441	586
7081.000	489	7151.005	571	7240.210	505	7320.472	596
7086.535	569	7151.035	571	7240.220	505	7320.475	596
7087.535	569	7151.105	571	7240.230	505	7320.481	596
7089.535	569	7151.110	571	7240.240	505	7320.485	596
7091.000	465	7151.206	565	7240.250	505	7320.491	586
7094.100	568	7151.208	565	7240.260	505	7320.530	583
7094.110	568	7151.300	566	7240.280	505	7320.560	583
7094.120	568	7152.005	571	7240.290	505	7320.570	583
7094.130	567	7152.035	571	7240.300	507	7320.620	583
7094.140	567	7153.005	571	7240.305	507	7320.630	583
7095.000	465	7153.035	571	7240.310	505	7320.631	583
7096.000	465	7154.035	570	7240.330	505	7320.700	583
7097.000	529	7156.005	571	7240.370	505	7320.721	583
7097.220	529	7156.035	571	7240.510	505	7320.730	587
7097.260	529	7157.035	571	7240.512	505	7320.790	589
7097.300	529	7158.035	540	7240.600	507	7320.792	589
7097.340	529	7158.100	541	7241.005	572	7320.793	589
7098.000	529	7158.150	541	7241.015	573	7320.794	589
7098.100	529	7159.035	539	7241.024	573	7320.795	589
7099.000	529	7161.000	489	7241.045	573	7320.796	589
7100.000	465	7161.700	489	7241.065	573	7320.810	587
7102.000	465	7163.500	490	7241.500	572	7320.812	587
7109.035	293	7163.550	490	7242.005	572	7320.813	584
7109.200	497	7163.560	490	7242.015	573	7320.814	585
7111.000	534	7163.565	490	7246.010	562	7320.820	587
7111.100	534	7164.035	480	7246.030	562	7320.830	586
7111.210	537	7165.035	480	7246.060	562	7320.950	583
7111.212	537	7166.035	480	7246.100	562	7338.120	328
7111.214	537	7166.735	480	7246.400	562	7338.130	328
7111.220	537	7167.000	571	7246.420	557	7338.160	329
7111.222	537	7169.535	573	7246.500	566	7338.161	329
7111.224	537	7170.535	573	7255.035	539	7338.162	329
7111.250	538	7174.535	573	7256.035	541	7338.163	329
7111.252	538	7178.535	573	7257.005	539	7338.164	329
7111.300	531	7183.100	487	7257.035	539	7338.165	329
7111.310	531	7184.035	480	7257.050	540	7338.166	329
7111.350	531	7185.035	480	7257.100	539	7338.167	329
7111.900	534	7186.035	480	7257.105	539	7338.168	329
7112.000	534	7186.735	480	7257.150	540	7338.170	329
7113.000	504	7200.001	510	7257.200	539	7338.171	329
7115.000	490	7200.210	585	7264.035	480	7338.220	328
7116.500	535	7200.214	585	7265.035	480	7338.320	328
7119.140	486	7200.215	585	7266.035	480	7391.000	89
7119.155	486	7200.216	585	7269.135	540	7394.035	569
7119.250	487	7200.217	585	7269.235	541	7396.000	89
7119.255	487	7200.450	585	7280.035	508	7400.000	89
7119.400	487	7200.630	508	7280.100	509	7401.000	558
7119.455	487	7200.800	417	7281.035	614	7402.000	558
7124.035	547	7200.810	417	7281.200	613	7404.000	506
7140.535	542	7218.035	533	7282.035	563	7408.510	506
7143.035	482	7219.035	533	7282.135	563	7411.000	558
7144.035	482	7220.500	536	7283.035	563	7412.510	506
7145.005	482	7220.600	534	7284.135	555	7433.035	570
7145.035	482	7228.035	533	7296.000	558	7437.035	570
7145.535	483	7240.110	505	7297.000	558	7445.000	89
7145.605	482	7240.120	505	7298.000	558	7450.035	572
7145.635	482	7240.130	506	7299.000	558	7451.000	67
7145.705	482	7240.150	506	7300.230	574	7455.030	522
7145.735	482	7240.160	506	7300.240	574	7462.000	67
7147.035	489	7240.170	506	7300.250	574	7463.100	67

# List of model numbers

## 7463.200 to 7824.282

Model No.	Page	Model No.	Page	Model No.	Page	Model No.	Page
7463.200	67	7507.010	55	7552.214	595	7820.650	84
7464.035	480	7507.020	56	7552.220	596	7820.700	84
7465.035	480	7507.030	56	7552.420	596	7820.710	84
7466.035	480	7507.100	55	7552.510	593	7820.730	84
7466.735	480	7507.110	55	7561.500	366	7820.740	84
7469.535	573	7507.120	56	7570.535	573	7820.750	84
7470.535	573	7507.200	56	7574.535	573	7820.770	84
7474.535	573	7507.210	56	7578.535	573	7820.800	84
7478.535	573	7507.220	56	7581.500	366	7820.810	84
7480.035	509	7507.706	554	7582.500	366	7820.850	84
7480.300	509	7507.709	554	7604.000	506	7821.100	83
7484.035	480	7507.712	554	7608.510	506	7821.200	83
7485.035	480	7507.715	554	7610.000	535	7821.300	83
7486.035	480	7507.718	554	7611.000	535	7821.340	83
7486.735	480	7507.721	554	7641.000	65	7821.410	83
7492.060	560	7507.740	374	7643.000	65	7821.500	83
7492.070	560	7507.750	371	7644.000	66	7821.510	83
7492.300	560	7507.755	371	7644.400	487	7821.600	84
7492.400	560	7507.760	222	7645.000	65	7821.610	84
7492.500	560	7526.050	424	7685.000	553	7821.650	84
7493.000	373	7526.750	383	7688.000	553	7821.700	84
7493.100	373	7526.755	383	7696.000	553	7821.710	84
7493.230	373	7526.760	383	7698.000	553	7821.730	84
7494.000	558	7526.770	383	7705.035	518	7821.740	84
7495.000	374	7526.780	383	7705.110	418	7821.750	84
7501.000	54	7526.785	383	7705.120	418	7821.770	84
7501.100	567	7526.790	383	7705.235	517	7821.800	84
7502.013	57	7526.795	383	7705.706	553	7821.810	84
7502.014	57	7526.800	383	7705.709	553	7821.850	84
7502.016	57	7526.807	436	7705.712	553	7824.086	387
7502.024	57	7526.820	383	7705.715	553	7824.106	387
7502.026	57	7526.827	436	7705.718	553	7824.120	387
7502.034	57	7526.829	383	7705.721	553	7824.126	387
7502.035	57	7526.834	383	7706.135	61	7824.127	403
7502.036	57	7526.850	383	7709.135	61	7824.128	387
7502.044	58	7526.860	383	7709.535	60	7824.130	406
7502.045	58	7526.964	470	7709.735	60	7824.132	406
7502.046	58	7541.000	504	7712.135	61	7824.146	387
7502.054	58	7542.000	504	7715.135	61	7824.148	387
7502.056	58	7543.000	504	7715.535	60	7824.166	387
7502.064	58	7544.000	504	7715.735	60	7824.168	387
7502.066	58	7545.000	504	7718.135	61	7824.180	387
7502.114	58	7546.000	504	7721.135	61	7824.183	403
7502.124	58	7547.000	504	7721.535	60	7824.186	387
7502.126	58	7548.000	504	7721.735	60	7824.188	387
7502.136	58	7548.210	502	7752.950	504	7824.200	387
7502.144	58	7549.000	504	7794.420	549	7824.201	403
7502.146	58	7552.002	591	7794.740	549	7824.202	403
7502.166	58	7552.020	592	7816.120	387	7824.203	403
7502.203	554	7552.030	592	7816.200	387	7824.204	403
7502.204	554	7552.040	592	7816.360	404	7824.205	403
7502.205	554	7552.100	591	7816.362	404	7824.206	387
7502.206	554	7552.110	591	7816.380	404	7824.207	403
7502.220	424	7552.120	596	7816.382	404	7824.208	387
7502.240	503	7552.122	596	7820.100	83	7824.220	387
7502.260	503	7552.140	596	7820.200	83	7824.222	403
7502.302	528	7552.142	596	7820.300	83	7824.223	403
7502.304	528	7552.200	594	7820.340	83	7824.224	403
7502.310	517	7552.201	595	7820.350	83	7824.225	403
7502.436	57	7552.202	595	7820.410	83	7824.226	387
7502.446	58	7552.203	595	7820.500	83	7824.227	403
7502.630	59	7552.204	595	7820.510	83	7824.228	387
7502.660	59	7552.205	595	7820.600	84	7824.280	404
7507.000	55	7552.212	594	7820.610	84	7824.282	404

# List of model numbers

## 7824.310 to 7856.719

Model No.	Page	Model No.	Page	Model No.	Page	Model No.	Page
7824.310	388	7826.605	436	7827.823	557	7831.631	549
7824.312	388	7826.625	436	7827.824	557	7831.641	549
7824.360	404	7826.645	436	7828.040	465	7831.723	390
7824.362	404	7826.665	436	7828.050	465	7831.724	390
7824.380	404	7826.669	437	7828.060	465	7831.726	390
7824.382	404	7826.685	436	7828.061	532	7831.800	94
7824.490	404	7826.689	437	7828.062	532	7831.802	94
7824.510	388	7826.750	296	7828.080	465	7831.803	94
7824.520	425	7826.760	437	7828.081	532	7831.810	94
7824.522	425	7826.766	437	7828.082	532	7831.812	94
7824.525	425	7826.768	437	7828.100	465	7831.813	94
7824.540	400	7826.780	437	7828.101	532	7855.340	372
7824.560	389	7826.786	437	7828.102	532	7855.342	372
7824.580	389	7826.788	437	7828.120	465	7856.003	202
7824.650	392	7826.805	436	7828.121	532	7856.005	202
7825.150	372	7826.806	437	7828.122	532	7856.006	202
7825.250	372	7826.809	437	7828.600	481	7856.008	202
7825.260	372	7826.825	436	7828.660	481	7856.010	202
7825.342	377	7826.845	436	7828.680	481	7856.011	204
7825.350	382	7826.865	436	7828.800	481	7856.013	204
7825.360	382	7826.866	437	7828.880	481	7856.014	204
7825.361	382	7826.869	437	7828.950	483	7856.015	201
7825.364	381	7826.885	436	7828.951	484	7856.016	202
7825.365	381	7826.886	437	7828.960	483	7856.017	201
7825.366	382	7826.889	437	7828.961	484	7856.018	201
7825.367	383	7827.000	556	7828.970	483	7856.019	204
7825.375	518	7827.023	557	7828.971	484	7856.020	202
7825.380	382	7827.024	557	7829.100	504	7856.022	204
7825.381	382	7827.050	536	7829.110	504	7856.023	204
7825.382	381	7827.061	549	7829.150	502	7856.025	204
7825.384	381	7827.080	549	7829.152	502	7856.026	204
7825.385	381	7827.081	549	7829.200	502	7856.027	204
7825.386	382	7827.100	549	7829.300	417	7856.030	204
7825.387	383	7827.101	549	7829.400	479	7856.043	202
7825.388	382	7827.120	549	7830.100	80	7856.070	203
7825.601	361	7827.121	549	7830.110	80	7856.080	203
7825.603	361	7827.140	549	7830.130	81	7856.081	201
7825.605	361	7827.141	549	7830.200	80	7856.082	203
7825.607	365	7827.160	549	7830.202	81	7856.090	203
7825.608	365	7827.161	549	7830.230	81	7856.095	203
7825.610	381	7827.180	549	7830.240	81	7856.100	203
7825.612	381	7827.181	549	7830.250	81	7856.101	201
7825.620	382	7827.200	549	7830.260	82	7856.110	203
7825.622	383	7827.201	549	7830.270	81	7856.120	203
7825.660	381	7827.220	549	7830.330	81	7856.130	203
7825.680	381	7827.221	549	7830.335	81	7856.140	203
7825.801	361	7827.300	488	7830.380	81	7856.150	203
7825.803	361	7827.310	538	7830.550	82	7856.160	203
7825.805	361	7827.320	538	7830.670	82	7856.170	204
7825.807	365	7827.330	538	7830.850	80	7856.180	203
7825.808	365	7827.480	556	7831.429	323	7856.190	203
7825.810	381	7827.490	556	7831.433	92	7856.201	203
7825.812	381	7827.520	565	7831.438	92	7856.203	510
7825.860	381	7827.532	565	7831.442	92	7856.204	510
7825.880	381	7827.534	565	7831.446	92	7856.220	203
7825.900	375	7827.536	565	7831.453	93	7856.230	203
7826.245	436	7827.544	566	7831.463	93	7856.231	201
7826.360	223	7827.550	556	7831.472	535	7856.240	203
7826.366	223	7827.554	557	7831.481	92	7856.321	202
7826.368	223	7827.560	556	7831.485	92	7856.323	202
7826.480	223	7827.570	556	7831.570	529	7856.710	550
7826.486	223	7827.590	555	7831.571	529	7856.713	550
7826.488	223	7827.600	556	7831.611	549	7856.716	550
7826.588	437	7827.800	556	7831.621	549	7856.719	550

# List of model numbers

## 7856.722 to 8600.665

Model No.	Page	Model No.	Page	Model No.	Page	Model No.	Page
7856.722	550	7890.020	597	7999.980	324	8115.235	385
7856.725	550	7890.206	597	7999.981	324	8126.235	385
7856.728	550	7890.208	597	7999.982	324	8126.500	386
7856.731	550	7890.226	597	7999.983	324	8128.235	385
7856.734	550	7890.228	597	7999.984	324	8145.235	385
7857.130	200	7890.500	597	7999.985	324	8146.235	385
7857.150	200	7950.100	554	7999.986	324	8148.235	385
7857.180	200	7950.150	430	7999.987	324	8165.235	385
7857.190	200	7950.200	430	7999.988	324	8166.235	385
7857.300	200	7952.100	496	7999.989	324	8168.235	385
7857.310	200	7963.310	560	7999.990	324	8170.235	385
7857.320	200	7963.410	560	7999.991	326	8173.235	385
7857.321	200	7963.510	560	7999.992	326	8174.235	385
7857.350	200	7963.610	560	7999.999	322	8175.235	385
7857.364	193	7963.710	560	8000.100	359	8176.235	385
7857.366	198	7966.035	221	8000.500	359	8180.235	385
7857.372	198	7967.000	438	8001.040	358	8184.235	385
7857.410	196	7968.035	221	8001.050	358	8184.500	386
7857.420	198	7980.000	222	8001.060	358	8185.235	385
7857.421	347	7980.100	222	8001.240	358	8185.500	386
7857.423	347	7980.148	222	8001.250	358	8186.235	385
7857.424	347	7986.035	221	8001.260	358	8186.500	386
7857.430	190	7988.035	221	8001.280	358	8188.235	385
7857.431	190	7990.012	346	8001.450	358	8204.500	73
7857.432	190	7990.014	346	8001.460	358	8205.500	73
7857.433	190	7990.101	345	8001.601	358	8206.500	74
7857.434	190	7990.103	345	8001.605	358	8208.500	74
7857.435	196	7990.201	345	8001.621	358	8226.500	75
7857.437	196	7990.203	345	8001.625	358	8245.500	70
7857.440	196	7990.205	345	8001.650	358	8265.500	71
7857.441	196	7990.206	345	8001.660	358	8284.500	71
7857.442	196	7990.207	345	8001.661	358	8285.500	72
7857.443	197	7990.208	345	8001.665	358	8286.500	72
7857.444	197	7990.209	345	8001.680	358	8360.920	366
7857.445	197	7990.210	345	8001.681	358	8366.000	108
7857.448	197	7990.211	345	8001.685	358	8366.100	108
7857.482	190	7990.213	346	8001.800	358	8366.200	108
7857.483	190	7990.301	345	8001.801	358	8366.300	108
7857.488	196	7990.303	345	8001.805	358	8366.400	108
7857.800	199	7990.305	345	8001.821	358	8368.000	108
7857.801	199	7990.306	345	8001.825	358	8368.100	108
7857.802	199	7990.307	345	8001.840	358	8404.300	401
7857.803	199	7990.308	345	8001.850	358	8450.600	172
7858.100	546	7990.309	345	8001.861	358	8450.680	76
7858.160	532	7990.310	345	8001.880	358	8451.600	172
7858.162	532	7990.311	345	8001.881	358	8452.600	172
7858.200	536	7990.313	346	8001.885	358	8453.600	172
7858.488	224	7995.969	323	8001.940	358	8454.600	172
7859.120	203	7995.992	322	8001.950	358	8455.600	172
7859.130	203	7999.892	323	8004.500	73	8456.600	172
7859.212	203	7999.893	323	8005.500	73	8457.600	172
7859.215	510	7999.896	324	8006.500	74	8484.300	401
7859.222	203	7999.897	324	8080.500	71	8504.300	401
7859.225	510	7999.898	322	8084.500	71	8505.300	401
7859.232	203	7999.961	326	8100.235	385	8584.300	401
7859.235	510	7999.962	326	8104.235	385	8585.300	401
7870.614	569	7999.963	326	8104.500	386	8600.255	363
7870.830	569	7999.964	326	8105.235	385	8600.265	363
7885.000	223	7999.965	326	8105.500	386	8600.455	363
7885.100	223	7999.966	326	8106.235	385	8600.465	363
7885.200	223	7999.970	323	8106.500	386	8600.510	363
7886.000	223	7999.977	324	8106.580	76	8600.520	363
7886.100	223	7999.978	324	8108.235	385	8600.655	363
7886.200	223	7999.979	324	8108.500	386	8600.665	363

# List of model numbers

## 8600.855 to 8800.080

Model No.	Page	Model No.	Page	Model No.	Page	Model No.	Page
8600.855	363	8605.300	401	8612.000	459	8614.675	448
8600.865	363	8605.500	73	8612.010	460	8614.680	448
8601.000	361	8606.300	401	8612.020	459	8614.840	448
8601.010	362	8606.500	74	8612.030	459	8614.850	448
8601.015	362	8608.500	74	8612.040	459	8614.880	448
8601.025	362	8609.020	392	8612.050	459	8616.602	262
8601.026	362	8609.030	392	8612.060	459	8616.622	262
8601.030	362	8609.040	389	8612.080	459	8616.700	263
8601.040	362	8609.050	389	8612.100	459	8616.710	263
8601.050	362	8609.060	389	8612.120	459	8616.720	263
8601.060	362	8609.080	389	8612.130	459	8616.750	263
8601.065	362	8609.100	390	8612.140	459	8616.760	263
8601.080	362	8609.110	390	8612.150	459	8616.761	263
8601.085	362	8609.120	390	8612.160	459	8616.762	263
8601.086	362	8609.130	390	8612.180	459	8616.772	263
8601.100	362	8609.140	391	8612.200	450	8616.773	263
8601.110	365	8609.150	391	8612.240	462	8616.802	262
8601.130	365	8609.160	391	8612.250	462	8616.822	262
8601.140	365	8609.170	391	8612.260	462	8626.300	401
8601.200	361	8609.190	391	8612.280	462	8626.500	75
8601.300	361	8609.260	389	8612.400	469	8645.500	70
8601.400	361	8609.390	391	8612.410	469	8665.500	71
8601.450	370	8609.840	389	8612.500	460	8684.300	401
8601.500	361	8609.850	389	8612.520	460	8684.500	71
8601.600	361	8609.860	389	8612.550	460	8685.300	401
8601.602	361	8610.600	402	8612.560	460	8685.500	72
8601.605	361	8610.620	402	8612.580	460	8686.300	401
8601.640	77	8610.680	402	8612.600	450	8686.500	72
8601.660	77	8610.800	402	8612.650	461	8700.000	396
8601.680	370	8610.820	402	8612.660	461	8700.010	76
8601.800	361	8610.880	402	8612.680	461	8700.060	385
8601.802	361	8611.010	415	8612.750	461	8700.120	511
8601.805	361	8611.020	415	8612.760	461	8700.140	399
8601.850	361	8611.030	415	8612.780	461	8700.150	399
8601.860	77	8611.040	415	8612.960	466	8700.160	399
8601.905	361	8611.045	415	8612.980	466	8700.600	511
8601.915	361	8611.050	415	8613.000	551	8700.680	76
8601.920	361	8611.060	415	8613.010	552	8700.800	511
8601.980	361	8611.070	415	8613.020	551	8700.840	385
8602.000	361	8611.080	402	8613.030	552	8700.850	385
8602.015	362	8611.100	421	8613.040	552	8701.000	367
8602.025	362	8611.110	421	8613.060	551	8701.040	367
8602.030	362	8611.120	421	8613.070	551	8701.050	367
8602.040	362	8611.130	421	8613.080	551	8701.060	367
8602.050	362	8611.140	421	8613.150	561	8701.180	425
8602.060	362	8611.150	421	8613.160	561	8701.200	367
8602.065	362	8611.160	421	8613.180	561	8701.600	367
8602.080	362	8611.170	421	8613.300	552	8701.800	367
8602.085	362	8611.180	416	8613.360	552	8702.000	367
8602.100	361	8611.190	416	8613.640	77	8702.040	367
8602.200	361	8611.200	416	8613.660	77	8702.050	367
8602.400	361	8611.210	418	8613.860	77	8702.060	367
8602.500	361	8611.220	421	8614.040	448	8702.200	367
8602.600	361	8611.250	415	8614.050	448	8702.600	367
8602.605	361	8611.260	415	8614.060	448	8702.800	367
8602.800	361	8611.270	415	8614.100	449	8800.020	425
8602.805	361	8611.280	415	8614.180	451	8800.030	425
8602.850	361	8611.290	415	8614.200	451	8800.040	402
8602.905	361	8611.300	402	8614.240	448	8800.050	444
8602.915	361	8611.330	415	8614.250	448	8800.060	511
8602.920	361	8611.340	415	8614.260	448	8800.070	418
8602.980	361	8611.350	415	8614.640	448	8800.071	386
8604.300	401	8611.360	415	8614.650	448	8800.075	377
8604.500	73	8611.370	417	8614.660	448	8800.080	511

# List of model numbers

## 8800.090 to 9665.780

Model No.	Page	Model No.	Page	Model No.	Page	Model No.	Page
8800.090	444	8800.880	399	9106.210	32	9511.000	29
8800.100	511	8800.892	399	9107.210	32	9511.100	29
8800.110	387	8800.900	481	9108.210	32	9512.000	29
8800.120	511	8800.910	481	9108.700	33	9512.100	29
8800.130	462	8800.920	366	9110.210	32	9513.000	29
8800.150	479	8800.950	425	9110.700	33	9513.100	29
8800.160	479	8801.000	405	9111.210	32	9514.000	29
8800.170	399	8801.010	405	9112.210	32	9514.050	30
8800.180	479	8801.310	296	9112.700	33	9514.100	29
8800.190	425	8801.320	296	9113.210	32	9515.000	29
8800.200	376	8801.330	296	9113.700	33	9515.100	29
8800.210	376	8801.340	296	9114.210	32	9516.000	29
8800.220	375	8801.350	296	9114.700	33	9516.100	29
8800.230	425	8801.380	296	9116.210	32	9517.000	29
8800.240	479	8801.450	405	9116.700	33	9517.100	29
8800.280	445	8801.735	433	9117.210	32	9518.000	29
8800.290	375	8801.745	433	9117.700	33	9518.100	29
8800.300	463	8801.755	433	9118.210	32	9519.000	29
8800.310	463	8801.765	433	9118.700	33	9519.100	29
8800.320	463	8801.775	433	9119.210	32	9520.000	29
8800.330	473	8802.060	512	9121.122	33	9520.100	29
8800.340	477	8802.065	513	9121.160	33	9521.000	29
8800.350	477	8802.080	512	9121.230	33	9521.050	30
8800.360	471	8802.085	513	9123.000	33	9521.100	29
8800.370	472	8802.100	512	9201.600	177	9522.000	29
8800.380	463	8802.105	513	9202.600	177	9522.100	29
8800.390	363	8802.120	512	9203.600	177	9523.000	29
8800.400	395	8802.125	513	9204.600	177	9523.100	29
8800.410	395	8802.160	512	9205.600	177	9524.000	29
8800.420	396	8802.165	513	9206.600	177	9524.100	29
8800.430	397	8802.220	446	9207.600	177	9530.000	30
8800.470	398	8802.260	446	9208.600	177	9531.000	30
8800.490	396	8802.280	446	9209.600	177	9545.000	31
8800.500	395	8804.300	401	9214.000	503	9547.000	31
8800.510	525	8804.500	73	9266.000	440	9548.000	31
8800.520	525	8805.300	401	9301.000	176	9549.000	31
8800.531	526	8805.500	73	9302.000	176	9550.000	31
8800.540	525	8806.300	401	9303.000	176	9564.000	31
8800.560	488	8806.500	74	9304.000	176	9565.000	31
8800.570	525	8806.580	76	9305.000	176	9566.000	31
8800.580	488	8808.500	74	9306.000	176	9567.000	31
8800.590	395	8826.500	75	9401.600	176	9568.000	31
8800.600	499	8845.500	70	9402.600	176	9580.000	31
8800.610	444	8865.500	71	9403.600	176	9581.000	31
8800.620	499	8880.500	72	9404.600	176	9582.000	31
8800.630	444	8881.500	72	9405.600	176	9583.000	31
8800.640	464	8884.500	71	9406.600	176	9659.525	434
8800.650	464	8885.500	72	9407.600	176	9659.535	434
8800.660	499	8886.500	72	9408.600	176	9659.545	434
8800.670	399	8900.050	393	9409.600	176	9659.555	434
8800.680	499	8900.060	393	9500.000	28	9660.210	469
8800.690	500	8900.840	393	9500.050	30	9660.220	469
8800.710	425	8900.850	393	9502.000	28	9660.235	434
8800.750	526	9055.310	590	9504.000	28	9660.245	434
8800.751	526	9055.312	590	9505.000	28	9660.255	434
8800.752	526	9055.410	590	9506.000	28	9660.265	434
8800.753	526	9055.412	590	9507.000	28	9660.935	434
8800.754	526	9100.210	32	9508.000	28	9660.945	434
8800.806	471	9101.210	32	9508.050	30	9660.955	434
8800.808	471	9102.210	32	9508.100	28	9660.965	434
8800.830	377	9103.210	32	9509.000	28	9665.750	435
8800.840	399	9104.210	32	9509.100	28	9665.760	435
8800.850	399	9105.210	32	9510.000	28	9665.770	435
8800.860	399	9105.700	33	9510.100	28	9665.780	435

# List of model numbers

## 9665.785 to 9911.396

Model No.	Page	Model No.	Page	Model No.	Page	Model No.	Page
9665.785	435	9673.941	468	9754.025	186	9765.095	451
9665.903	434	9673.950	468	9754.035	187	9765.096	451
9665.913	434	9673.951	468	9754.045	187	9765.097	451
9665.923	434	9673.953	468	9755.015	186	9765.120	441
9665.943	434	9673.960	468	9755.025	187	9765.150	497
9665.953	434	9673.961	468	9755.035	187	9765.182	368
9665.963	434	9673.981	468	9755.045	187	9765.191	451
9671.446	434	9673.983	468	9755.055	187	9768.152	287
9671.448	434	9673.995	468	9755.065	186	9774.105	185
9671.468	434	9674.056	469	9756.015	186	9774.205	185
9671.488	434	9674.058	469	9756.025	187	9774.305	185
9671.536	434	9751.015	186	9756.035	187	9774.405	185
9671.538	434	9751.025	186	9756.045	187	9776.102	286
9671.546	434	9751.035	186	9756.055	187	9776.152	286
9671.548	434	9751.045	187	9756.065	186	9776.500	286
9671.568	434	9751.055	187	9757.015	186	9776.550	286
9671.586	434	9751.065	187	9757.025	187	9783.510	183
9671.588	434	9751.075	186	9757.035	187	9783.520	183
9671.636	434	9751.085	187	9757.045	187	9783.530	183
9671.638	434	9752.015	187	9757.055	187	9783.540	183
9671.646	434	9752.025	187	9757.065	186	9783.550	183
9671.648	434	9753.015	186	9758.015	186	9783.610	183
9671.666	434	9753.025	187	9758.025	187	9784.520	184
9671.668	434	9753.035	186	9758.035	187	9784.540	184
9671.686	434	9753.045	186	9758.045	187	9784.620	184
9671.688	434	9753.055	186	9758.055	187	9784.640	184
9671.736	434	9753.065	187	9761.212	287	9785.040	416
9671.738	434	9753.075	186	9762.212	287	9785.042	416
9671.746	434	9753.085	186	9764.040	287	9785.511	384
9671.748	434	9753.095	186	9765.051	287	9785.512	384
9671.766	434	9753.105	187	9765.071	368	9785.513	384
9671.768	434	9753.115	186	9765.072	368	9785.514	384
9671.786	434	9753.125	186	9765.082	368	9791.015	182
9671.788	434	9753.135	186	9765.083	368	9791.025	182
9671.846	434	9753.145	187	9765.084	368	9791.035	182
9671.848	434	9753.155	186	9765.085	368	9791.045	182
9673.901	475	9753.165	186	9765.086	368	9911.396	611
9673.902	475	9753.175	186	9765.087	368		
9673.903	475	9753.185	186	9765.088	368		
9673.915	468	9753.195	186	9765.089	368		
9673.920	468	9753.205	186	9765.090	451		
9673.940	468	9754.015	186	9765.092	451		

# Index

## A

Access sensor	583
Accessories	355 – 624
– Climate control	291 – 305
– for cast aluminium enclosures GA	33
– for Data Rack	558
– for polycarbonate enclosures PK	31
– for Power System Module	204
– for UPS	196 – 199
– Hygienic Design	156, 157
– Support arm systems	142 – 146
– TopConsole	105
Accommodation system, 2 U	
– for LSA installation kit	574
Acoustic components	
– for signal pillars, modular	621
Acrylic glazed cover	408
Active kit for TE	224
Adaptor	
– 3 U	562
– for levelling feet	375
– for L-shaped mounting angles	488
– for Siemens Pro-Panel	142
– for twin castors	375
– Metric to 482.6 mm (19")	562
Adaptor bracket	
– for TS	471
Adaptor frame	
– for wall-mounted cooling units	298
Adaptor kit, 3 U	562
Adaptor pieces, 482.6 mm (19")	
– for TS, ES	552
Adaptor power pack	
for LED system light	495
Adaptor rail	
– for PS compatibility	463
Adaptor sections, 482.6 mm (19")	
– for TS	551
– for TS electronic enclosures	552
Adaptor sleeve, Flex-Block	359
Adaptors	
– for connector cut-outs	392
Add-on cover	283
Add-on unit	
– GSM unit quad-band	587
Adhesive measurement strip	554
Adjacent door latch for TS	417
Adjustable frame	
– for air/air heat exchangers	297
Adjustment set for support section	143
AE	
– Compact enclosures	44 – 46
– Wall-mounted distributors	65, 66
AE Laser Express	337
Air baffle plates for TS	565
Air diverter	293
Air duct system	
– for roof-mounted cooling units	
and air/water heat exchangers	291
Air/air heat exchangers	226 – 229
– Wall-mounted,	
railway-compatible version	228
Air/water heat exchangers	252 – 261
Aisle containment	278
All-glass door for DK-TS	404
Alternate frame, magnetic	430
Aluminium rivet	526
Aluminium strip	601
Analog airflow sensor	583
Analog differential pressure sensor	583
Angle adaptor 90°	146
Angle bracket PS	473
Angle piece	474
Angular baying brackets	397, 398
Anti-twist guard	
for cable shunting ring	534
AP universal consoles	107
AS interface element	
– for signal pillars, modular	621

Assembly block for TS	463
Assembly parts	
– for system punchings	501
Assembly screws	568
Assembly tool	
– for HD cable gland	521
Attachment	
– for punched section	
with mounting flange TS	460
– for wall mounting HD	156
– Pole clamp	441
Auto Range power pack	302

## B

Base	
– for tubular door frame	616
Base configuration rail for CM	461
Base frame, divided	377
Base module for cable entry	383
Base mount	
– for cast feet	151
Base mounting bracket	376
Base mounting plate	
– for base/plinth	364
Base/plinth	
– Complete, sheet steel	369
– Complete, stainless steel	370
– for areas at risk from earthquakes	77
– for FlatBox	371
– Stationary	366
Base/plinth adaptor	
– for levelling feet	375
– for twin castors	375
Base/plinth baying brackets	362
Base/plinth cap	365
Base/plinth components	
– Front and rear, sheet steel	361
– Front and rear, stainless steel	367
Base/plinth trim panels	
– Side, sheet steel	362
– Side, stainless steel	367
– with brush strip	365
– with designer trim panels	366
Base/plinth trim, modular	367
Basic enclosures CS	183, 184
Basic modules	
– CMC III Processing Unit	580
– CMC III Processing Unit Compact	580
Basic Safe	322
Battery Manager RiBat	199
Battery packs	
– for PMC 12	196
Baying attachment	399
Baying brackets	
– for TS base/plinth	362
– for TS/TS and TS/PS	398
Baying clamp	395, 396
– for back-to-back mounting	399
Baying clip, Flex-Block	359
Baying connector	
– for Data Rack	558
– for TS	396, 400
Baying cover, top	399
Baying kit	
– for KL, AE	400
– for TE/TE	400
Baying seal, EMC	500
Baying system	394 – 401
Baying systems TS 8	70 – 77
– IP 66/NEMA 4X	76
– Stainless steel	172
Bit HD	156
Blanking cover	
– for fan-and-filter units/outlet filters	303
– for fibre-optic cut-outs	574
Blanking panel	571
Blanking plates, 482.6 mm (19")	564

Bottom-mounted adaptor	
– for enclosure internal thermostat	294
and hygrostat	294
Bracket	
– Wall bracket KS	440
– Wall bracket TS/ES	440
Bracket/spacer	474
Brush strip	518
– Vertical	566
Built-in keyboard 19"74 U	609
Bus enclosures BG	39 – 41
– Stainless steel	161
BUS system SK	295

## C

C rails	465 – 467
– for cable chamber enclosures	469
Cable attachment	530
Cable chamber for TS	363
Cable clamp rails	
– C rail	527
– Depth-variable	532
– for TS and 482.6 mm (19")	
mounting frames	532
– Mounting angle	527
Cable clamp strap	
– for patch panels	535
Cable clamp, variable	532
Cable clamping bracket	528
Cable clamps	
– for cable clamp rails	527
– for C rails	529
Cable conduit/cable conduit holder	529
Cable duct	
– for mounting plate	526
– for TS/TE	538
– for vertical TS section	525
Cable entry	
– on gland plate for TS, CM, TP	512, 513
Cable entry glands	435
Cable entry grommets	512
Cable entry module CP-L, round	524
Cable entry panel	
– 482.6 mm (19")	542
Cable entry plates	511
Cable gland plates	
– Metal	516, 517
– Plastic	514, 515
Cable glands	
– Brass	519
– EMC	499
– for fibre-optic technology	522
– for IW worktops	522
– Polyamide	519
– Stainless steel, HD	521
Cable lock PSM	204
Cable management	525 – 536
Cable management duct	
– Horizontal, 482.6 mm (19")	541
Cable management panel	539 – 541
– 2 U	540
– for DK-TS	389
Cable manager	533
Cable route	
– for TS	536
– Vertical, for TS	536
Cable routing	
– 482.6 mm (19") mounting level	537 – 542
– Snap-in	531
Cable routing bars	537
Cable routing channel	
– 482.6 mm (19")	540
Cable shunting ring	534
Cable support, hinged	490
Cable tie fastener	531
Cable ties	530
Cable tray	
– on the mounting frame	536



Cable tray, 2 U	541	Condenser unit	283	CP-XL support arm system	138 – 141
Cage nut – front mounting, 482.6 mm (19")	568	Connecting plinth trim	365	CRAC system CW	274, 275
Cam lock HD	156	Connection accessories		CRAC system DX	276, 277
Cam locks	421	– CMC III	583	Crane bracket	398
– for operating panel	410	– for LED system light	495	Cross member	
Captive nuts M5/M6	567	– for lights	496	– adjustable	370
Captive nuts/threaded blocks	477	Connection adaptor		Cross-brace	
Cast aluminium enclosures GA	32, 33	– CP-L to CP-L	142	– for mounting plates, for TS, ES	447
Cast feet	371	– CP-L to CP-XL	142	CS	
Castors	374	– for signal pillar, LED compact	618	– Modular enclosures	186, 187
Cat 5 patch cable	596	Connection cable/extension	585	– New Basic enclosures	183, 184
CD/disk box	427	Connection cables	596	– Toptec	185
Central earthing point	502	– CAN-Bus	584	– Wall-mounted enclosures	182
Chillers for IT cooling	272	– for LED system lights	495		
Chillers for water		– for lights	496		
– in floor-standing enclosure	268, 269	– for power pack, TFT monitor	606		
– TopTherm	264 – 267	– for PSM busbar	204		
Circuit-breaker 10 A		Connection component			
– Connection component	496	– for signal pillars, modular	619		
Clamp rails for cables	527	Connection console CP-L			
Clamp strip, foam rubber	513	– for Beckhoff Control-Panels	142	Data Centre Container DCC	327
Client Access licence	346	Connection cover	604	Data distributors	569
Climate control		Connection element		Data Rack	88
– Modular Safe/Extend	325, 326	– with air circuit-breaker	496	DC fan mounting plate	
Climate control doors	249	Connection hose, bottom and top	283	– for TS	224
Climate control system CW	274	Connection kit	305	Deflector 90° for air duct system	291
Climate control system DX	276	Connection plates CP-L	143	Depth stay for mounting angles	
Climate control units		Connector gland	522, 524	– PS	553
– for CS Toptec	286	– Sealing frame	523	Depth stays	
Clipboard	603	– Sealing modules	523	– for Data Rack	558
Clips for gland plate	377	Connector grommets	512	Depth stays as installation kit	
CM base configuration rail	461	Connector pieces		– for mounting angles	556, 557
CM compact system enclosures	48, 49	– for TS punched rail 17 x 17 mm	475	Depth stays for mounting angles	
CM configurator	343	– Frame connector piece for TS	475	– TS	556
CMC III		Connectors		Digital enclosure internal	
– CAN-Bus connection cable	584	– Enclosure surface connector	603	temperature display and thermostat	293
– CAN-Bus Unit	580	– for enclosures	441	Display board with bracket	603
– I/O Unit	581	– for frame	442	Display Unit II	586
– Monitoring system	578	– for TS punched rail 17 x 17 mm	475	Distributor clip	538
– Mounting unit	585	Console for SSC	594, 595	Distributor racks	
– Power Unit	581	Consoles		– Data Rack	88, 558
– Processing Unit	582	– One-piece consoles AP	170	– TE 7000 open	88
– Processing Unit Compact	582	– One-piece consoles TP	106	Divider kit	
Cold Plate		– TopConsole	98 – 105	– for pull-out frame	547
– for frequency converters	262	– Universal consoles TP	107	Divider panel	
Combination angle	398	Contact cutter	500	– for module plates TS	390
Combination rails	528	Contact paint	500	– for TS	389
Comfort handle	415, 589	Contact washers	501	Divider panel seal, EMC	500
Comfort Panel	116, 117	Control unit for EC fan-and-filter units	294	Document clip, magnetic	430
Command panel		Converter for SSC	595	Door comfort handle	589
– Stainless steel	166, 167	Cooling medium for recooling systems	305	Door control module	589
– With display panel front	123	Cooling modules "Blue e"	248	Door Control System	588
Command panel configurator	343	Cooling units		Door kit	589
Command panel housing with door	121	– for CS modular enclosures	287	Door latch mechanism	
Compact climate control Modular Safe	325	– for CS Toptec	286	– for bayed suites	393
Compact enclosures		– Roof-mounted	244, 247	Door stay for escape routes for TS	429
– AE	44 – 46	– Wall-mounted	233, 243	Door switch	589
– EMC	179	Corner connectors		Door-mounted fan	
– HD	155	– for TS punched rail 17 x 17 mm	475	– for server enclosures TS, TE	225
Compact light	493	Corner enclosures TS 8	401	Door-operated switch	495, 496
Compact Panel	120	Corner handle	602	Door variants	402 – 406
– Wall mounting bracket	442	Courtesy light	492	Drawer	
Compact swing frame		Cover		– 482.6 mm (19")	563, 609
– for AE	547	– Acrylic glazed	408	– 482.6 mm (19"), for keyboard	
Compact system enclosures CM	48, 49	Cover cap		and mouse	612, 613
Compensating panel for TS	400	– for TS base/plinth components	365	– 482.6 mm (19"), for keyboards	614
Complete earthing kit	503	Cover hinge		– 482.6 mm (19") to accommodate	
– Extension kit	502	– for KL	425	surplus cable length	539
Component shelf		Cover plates		– Installation kits	563
– 482.6 mm (19") installation	482	– for connector cut-outs	392	– Tray	481
– for attachment to the 482.6 mm (19")		– for fan panels FlatBox	222	Dust guard trim	
system punchings	485 – 487	– for support arm connection	604	– for AE, CM, EB, KL, BG	432
– for frame attachment	480, 481	Cover retainer		– for TS, ES	432
– Heavy-duty	483, 484	– for KL	425		
– Installation kits	488	Cover with door for TS	392		
– Static installation on the		CP housing couplings			
482.6 mm (19") mounting frame	483	for desktop mounting	144		
Concrete base/plinth	368	CP-C support arm system	134 – 137		
Condensate collecting bottle	302	CP-L support arm system	130 – 133		
Condensate discharge	384	CP-L to CP-L	142		
Condensate hose	303	CP-S, steel, support arm system	126 – 129		
		CPU cable for SSC	596		

## D

Data Centre Container DCC	327
Data distributors	569
Data Rack	88
DC fan mounting plate	
– for TS	224
Deflector 90° for air duct system	291
Depth stay for mounting angles	
– PS	553
Depth stays	
– for Data Rack	558
Depth stays as installation kit	
– for mounting angles	556, 557
Depth stays for mounting angles	
– TS	556
Digital enclosure internal	
temperature display and thermostat	293
Display board with bracket	603
Display Unit II	586
Distributor clip	538
Distributor racks	
– Data Rack	88, 558
– TE 7000 open	88
Divider kit	
– for pull-out frame	547
Divider panel	
– for module plates TS	390
– for TS	389
Divider panel seal, EMC	500
Document clip, magnetic	430
Door comfort handle	589
Door control module	589
Door Control System	588
Door kit	589
Door latch mechanism	
– for bayed suites	393
Door stay for escape routes for TS	429
Door switch	589
Door-mounted fan	
– for server enclosures TS, TE	225
Door-operated switch	495, 496
Door variants	402 – 406
Drawer	
– 482.6 mm (19")	563, 609
– 482.6 mm (19"), for keyboard	
and mouse	612, 613
– 482.6 mm (19"), for keyboards	614
– 482.6 mm (19") to accommodate	
surplus cable length	539
– Installation kits	563
– Tray	481
Dust guard trim	
– for AE, CM, EB, KL, BG	432
– for TS, ES	432

# Index

## E

Earth clamps, EMC 500  
 Earth rails 504  
 Earth straps 501  
 Earthing kit  
 – for KL 503  
 – for QuickBox 503  
 – KE, for KL, AE, TS 503  
 – Pre-assembled, for DK-TS 504  
 Earthing kit, complete  
 – for DK-TS 502  
 – for TE 503  
 Earthing plate 502  
 Earthing point, central 502  
 Earthing strap 501  
 Earthquake base/plinth 77  
 Earthquake kit, TS 8 77  
 E-Box EB 37, 38  
 – EMC 178  
 Edge protector 522  
 EL wall-mounted distributors 60 – 64  
 Electric condensate evaporator EMC 302  
 – Compact enclosures AE 179  
 – Earth clamps 500  
 – E-Box EB 178  
 – Gland plates 499  
 – Shield bus 498, 499  
 – Shielding bracket 498  
 EMC cable glands 499  
 EMC seals  
 – Baying seal 500  
 – Divider panel seal 500  
 Enclosure attachment  
 – Tilting, base mounting CP-L, rectangular 143  
 – Tilting, top mounting 145  
 Enclosure connector, adjustable 441  
 Enclosure flange 151  
 Enclosure for tower PC 109  
 Enclosure heaters 289  
 Enclosure internal fan  
 – for TS 221  
 Enclosure internal thermostat 294  
 Enclosure keys 424  
 – Hygienic Design 156  
 Enclosure light 497  
 Enclosure panel fasteners, internal  
 – for TS 386  
 Enclosure reinforcement 151  
 Enclosure suites 394  
 Enclosure surface connector 603  
 Enclosure systems  
 – PC 108, 109  
 – Stainless steel 171, 172  
 – TS 69 – 77  
 Energy-Box 509  
 Energy-saving extractor plenum 305  
 Entry grommets  
 – for cables 512  
 – for connectors 512  
 EPLAN platform 338, 339  
 Ergoform-S lock system 419  
 ESD connection point 504  
 Ex enclosures 174 – 177  
 – Plastic 177  
 – Stainless steel 176  
 Explosion-proof cooling units 243  
 Extension cable 585  
 Extension kit  
 – for complete earthing kit 502  
 – for earth rail, vertical 504  
 Eyebolts 438

## F

Fan  
 – 24 V DC with speed monitoring 587  
 Fan Control System FCS 587  
 Fan expansion kit 222  
 – for door-mounted fan TS 225  
 Fan mounting plate  
 – for TS 221, 224  
 Fan roof, modular, two-piece  
 – for TS 223  
 Fan systems  
 – for TS 219  
 Fan unit, active  
 – for TE 224  
 Fan-and-filter units  
 – Accessories 299 – 302  
 – for filter technology 299 – 302  
 – TopTherm 212 – 216  
 Fastener  
 – for support arm connection 604  
 Fastening bolts  
 – for base/plinth 364  
 – for component shelves 490  
 Feet 371, 373, 374  
 Fibre-optic  
 – Blanking cover 574  
 – Breakout box, 1 U 572  
 – Cable management panel 541  
 – Patch panels 570, 573  
 – Shunting ring 535  
 – Small distributor, polycarbonate 67  
 – Splicing boxes and accessories 572, 573  
 – Splicing cassette holder 572  
 Filter holder for roof ventilation 304  
 Filter mats  
 – for base/plinth component, vented 366  
 – for climate control door/section door 300  
 – for cooling units 299, 300  
 – for discontinued cooling units 299  
 – for heat exchangers 300  
 – for one-piece gland plate 382  
 – for tangential fans/front outlet grilles 299  
 Fine filter mats  
 – for discontinued fan-and-filter units/outlet filters 302  
 – for fan-and-filter units 302  
 Fire alarm and extinguisher system DET-AC 328 – 329  
 Fixture with rods, 3 U  
 – for LSA strips 574  
 Flat screen 606  
 FlatBox 55, 56  
 FlatBox base/plinth 371  
 Flex-Block 358  
 Flex-Block base/plinth system 358  
 Flexible hose 263  
 Flow regulator valve 304  
 Fluid distribution manifold 263  
 FM  
 – Universal mounting bracket 575  
 Foam rubber cable clamp strip 513  
 Folding keyboard 609  
 Folding lever handle  
 – for CM 416  
 Fold-out tray  
 – for keyboard and mouse 609  
 Frame connector  
 – for Comfort Panel 442  
 Frame connector piece  
 – for TS punched rail 17 x 17 mm 475  
 Front cover 283  
 Front outlet grille 2 U  
 – for tangential fans 304  
 Front panels  
 – for Comfort Panel and Optipanel 604  
 – for Compact Panel 604  
 Fuel cell system 205

## G

Gas pressurised spring  
 – for viewing window 408  
 Gland plate  
 – for CM, TP 378 – 380  
 Gland plate modules for DK-TS 382  
 Gland plate modules, vented 382  
 Gland plates 514 – 518  
 – EMC 499  
 – for cable entry 435  
 – for CS New Basic enclosures 384  
 – for DK-TS, multi-piece 381  
 – for TS, one-piece 381  
 – Metal 516 – 518  
 – Plastic 514, 515  
 – with membranes, plastic 515  
 Glazed door  
 – for DK-TS 403  
 – for TS 402  
 Grommets  
 – for cable entry 512  
 – for connector entry 512  
 GSM unit quad-band 587  
 Guide  
 – for mounting plate 446

## H

Handle adaptor 402  
 Handle frame  
 – for operating housings 601  
 Handle set  
 – for Comfort Panel 600  
 – for Optipanel 600  
 Handles  
 – Corner handle 602  
 – Folding lever handle 416  
 – for component shelves 490  
 – for mounting plates 447  
 – Plastic handles 420  
 – Security handle with code 417  
 – Swivel handle 417  
 – T handles 420  
 – U handles 602  
 Heat exchangers  
 – Air/air 226 – 229  
 – Air/water 252 – 261  
 – for CS modular enclosures 287  
 – for CS Toptec 286  
 – LCP Inline CW and DX 280  
 – LCP Passive CW 282  
 – LCP rack CW and DX 279  
 – LCP T3+ CW 281  
 High density cable duct 538  
 Hinge attachment  
 – for partial mounting plate TS 449  
 Hinge pin remover 425  
 Hinged blanking plate 564  
 Hinged cable support 490  
 Hinged lid for interfaces 617  
 Hinges  
 – 130°/180° 425  
 – exterior, for GA 33  
 – for blanking plates 564  
 – for PK 31  
 – for TS side panel 387  
 Holder  
 – for cable conduit 529  
 – for mouse 615  
 – for protective bar 405  
 – for TFT 607  
 Horizontally hinged FT stay 408  
 Hose-proof hood 303  
 Housing coupling  
 – CP-XL for desktop mounting 144

HPC racks  
 – for High Performance Cooling 94  
 Hygienic Design HD  
 – Accessories 156, 157  
 – Bit 156  
 – Cable gland 521  
 – Cam lock 156  
 – Compact enclosures 155  
 – Enclosure key 156  
 – Levelling feet 156  
 – Rails for interior installation 157  
 – Terminal boxes 154  
 – Wall spacer bracket 156  
 Hygrostat 294

## I

Identification strips 409, 432  
 – for patch panels 571  
 Incandescent lamps  
 – for steady and flashing light components 620  
 Industrial Workstations 110, 111  
 – Base for tubular door frame 616  
 – Cast feet 371  
 Infill panels  
 – for adaptor sections 552  
 – for TS network enclosures 565  
 Infrared access sensor 583  
 Installation examples, rail systems 456 – 458  
 Installation kit  
 – Depth-variable 488, 563  
 – for back-to-back mounting plates TS 445  
 – for component shelves 488, 563  
 – for drawers 488, 563  
 – for mounting angles 555 – 557  
 – for swing frame, small 543  
 – TS, width-variable 556  
 Integrated louvres 298  
 Interconnecting cables  
 – for lights 495  
 Interface box 616  
 Interface board 295  
 Interface extension with wall connection and built-in RJ 45 module 616  
 Interface flaps  
 – modular 617  
 Interior door for AE IP 69K 406  
 Interior installation  
 – Rails for CM, TP 459  
 – Rails for AE 459  
 Internal latch  
 – for side panel, lockable 388  
 IP 66 baying systems TS 76  
 IP console  
 – for SSC premium 595  
 ISDN unit 586  
 Isolator door cover 393  
 IT configurator 343

## J

Junction box  
 – with multi-functional bracket 508

## K

Key 424  
 Keyboard  
 – Built-in keyboard with touchpad 609  
 – Pull-out 608  
 Keyboard drawer 612 – 614  
 Keyboard rack, 482.6 mm (19") 611  
 Keyboard support 610  
 Keyboard, 482.6 mm (19") 611  
 Kit for separate frame TS 479  
 KVM switches 591 – 596

## L

Label panel  
 – for signal pillars, modular 622  
 Latch for adjacent door TS 417  
 LCP Inline CW and DX 280  
 LCP Passive CW 282  
 LCP rack CW and DX 279  
 LCP T3+ CW 281  
 Leakage sensor 583  
 Levelling component  
 – for TS base/plinth 364  
 Levelling feet 371, 373, 374  
 – Hygienic Design 156  
 Lid for interfaces 617  
 Lights  
 – 1 U 497  
 – Compact light 493  
 – Courtesy light 492  
 – Enclosure light 497  
 – LED 494  
 – Standard light 492  
 – System lights 491  
 – Universal light 492  
 Lint screen 301  
 Liquid Cooling Package 279 – 283  
 Locating adaptor 143  
 Lock components for frame TS 402  
 Lock cover 422, 423  
 Lock cylinder inserts 422  
 Lock inserts 416, 421  
 Lock nut, stainless steel 521  
 Lock systems  
 – for compact enclosures, sheet steel 411  
 – for console systems and industrial workstation, sheet steel 413  
 – for enclosures and cases, stainless steel 414  
 – for large enclosures, sheet steel 412  
 Lockable and adjacent door for TS 405  
 Locking bar latch 418  
 Louvred grille  
 – for lint screen 301

## M

Master/slave adaptor  
 – for Thermoelectric Cooler 295  
 Measurement module PSM 204  
 Mechanical maintenance bypass 196  
 Membrane gland plate 515  
 Metal filters for climate control units 300  
 Metal gland plates 516  
 Microsoft Operations Manager 346  
 Mini-comfort handle 418  
 Mini-chillers 264, 265  
 Mini-fan 222  
 Modular climate control concept 248, 249  
 Modular enclosures CS 186, 187

Modular Safe 323  
 Modular Safe Extend 324  
 Module plates 391  
 – for TE 383  
 Monitor frame 409  
 Monitor switches 591, 592  
 Monitor, flat 606  
 Monitor/keyboard unit, 1 U 590  
 Monitoring 577  
 Monitoring system CMC III 578  
 Motion detector 583  
 Mounting  
 – Wall mounting bracket 441  
 Mounting angles  
 – Additional fastening attachment 555  
 – C rails 465, 467, 469  
 – for CS Basic and modular enclosures 553  
 – for CS Topotec 549  
 – for DK-EL 553  
 – for FlatBox 554  
 – for QuickBox 554  
 – for TS 549  
 – for VerticalBox 554  
 – Installation kits 553, 555 – 557  
 – Metric 549  
 Mounting block for AE 476  
 Mounting bracket 470, 472  
 – FM universal mounting bracket 575  
 – for CP 470  
 Mounting clip for support rails 467  
 Mounting components  
 – for signal pillar 622 – 624  
 Mounting frame  
 – 482.6 mm (19") 550  
 – for TS 557  
 Mounting kit  
 – for cable trays 536  
 – for Comfort Panel 605  
 – for Optipanel 605  
 – for VerticalBox 567  
 – Magnet 493  
 – TS, width-/depth-variable 555  
 Mounting kit PSM  
 – for busbar 204  
 Mounting kit, 2 U 557  
 Mounting panel 482.6 mm (19"), 2 U 566  
 Mounting plates 443, 469, 470  
 – Adjustment bracket for KS 446  
 – Attachment 444, 445  
 – Attachment for CM 447  
 – Cross-brace for TS, ES 447  
 – for cast aluminium enclosures GA 33  
 – for CS Basic and modular enclosures and for CS Topotec 451  
 – for KL and KL-HD 443  
 – for polycarbonate enclosures 31  
 – for TS 451  
 – Infill for TS 443  
 – Slide block for CM 446  
 – Slide rail for TS 446  
 – Small 450  
 – Transport handles for TS, ES 447  
 Mounting unit  
 – for enclosure frame 585  
 Mounting unit, 1 U 586  
 Mouse holder 615  
 Mousepad  
 – for keyboard rack 611  
 – Support 610, 614, 615  
 Multiple lock 423  
 Multi-seal inserts 520  
 Multi-tooth screws 478, 567

# Index

## N

NEMA 4X, NEMA 4	
– Enclosures TS	76
– Wall-mounted cooling units	242
Network cable	596
Network distribution enclosures	78 – 89
Network enclosures	
– Based on Rittal TE 7000	85 – 87
– Based on Rittal TS 8	80 – 84
New Basic enclosures CS	183 – 184
Noise protection kit for TS	392
Nuts	477
– for TS section	471
Nylon loop	530
Nylon loop cable holder	531

## O

One-piece consoles	
– AP, stainless steel	170
– TP, sheet steel	106
Operating housing	
– With handle strips	122
Operating panel	410
Optical components	
– for signal pillars, modular	620
Optipanel	118, 119
Outdoor climate control	
– Modular Safe	326
Outdoor enclosures	181 – 187
Outlet filter	303
Overflow valve	304
Overvoltage protection PSM	204

## P

Pair of mounting angles, second	558
Panel	540
– with solid tray	570
Paper removal flap	615
Parallel hot swap chassis UPS	197
Partial mounting plates	
– for ES, CS Basic	
– and modular enclosures	449
– for TS, CS Toptec	448
– Locatable	450
Partition	390
Patch cable, Cat 5	596
Patch panels	67, 569 – 571, 573
PC enclosure systems	108, 109
– Stainless steel	171
PE busbar	503
Pedestal, complete	148
Pedestal, modular	147
Perforated mounting strip	
– for AE stainless steel,	
– TP universal console	427
Perforated plate	
– Base/plinth trim, modular	367
Pillar	150
– Small	149
Pivot CP-L	145
Plastic	
– Base/plinth	358, 359
– Cable gland plates	514
– Enclosures KS	50, 51
– Ex enclosures	177
– Gland plates	515
– Handles	420
Plate	
– for base mounting	364
Plug-in PSM modules for busbar	201

PMC 12 relay card	196
PMC UPS accessories	196 – 199
Pole clamp	441
Polyamide reducers	
– for cable glands	520
Polycarbonate enclosures PK	28 – 31
Potential equalisation rail	504
Potential equalisation star	502
Power Control for SSC	596
Power Control Unit	510
Power Distribution Rack/Module	200
Power engineering software	341
Power packs	
– 24 V (DC)	302
– CMC III	584
– for PU II/Basic CMC/FCS	584
– for SSC	596
– for TFT monitor	606
Power System Module	201 – 204
Premium Panel	166
Pressure relief stoppers	384
Primer/paint	388
– Contact paint	500
Processing Unit Compact, CMC III	582
Processing Unit, CMC III	582
Programming cable	584
Protective bar	
– for TS	405
PSM busbar	201, 202
PSM socket modules	201 – 203
Pull-out frame, 482.6 mm (19")	547
Punched rails	
– 17 x 17 mm for TS	468
– 18 x 38 mm, TS	462
– 23 x 23 mm, PS	463
– 23 x 73 mm, PS	464
– 25 x 38 mm, TS	461
Punched section with mounting flange	
– 17 x 73 mm, TS	459, 460, 488
– 23 x 73 mm, PS	464
– 23 x 73 mm, TS	460
– for coupling section	469
Punched section without mounting flange	
– 23 x 73 mm, PS	464
– 45 x 88 mm, TS	461

## Q

Quality management	353
Quick-action vent valve	263
Quick-assembly block	474
QuickBox	57 – 59
Quick-change frame	
– for roof-mounted cooling units	297
Quick-fit baying clamps	395
Quick-release fastener	304
– for QuickBox	424

## R

Rack-mounted fans	217 – 218
Rail mounting bracket	476
Rail systems	456 – 470
Rails	
– Base configuration rail for CM	461
– for EMC shielding bracket	
– and strain relief	498
– for interior installation	157
– for interior installation AE	459
– for interior installation CM, TP	459
– Support rails for TS, CM, PC, TP	450
Rain canopies	
– for AE, CM	431
RCCMD software	347
Reinforcement	
– for enclosure	151

Reinforcement bracket	
– for TS, SE, TP universal console	377
Relay card PMC 12	196
RFID	
– Controller	597
– Mounting frame	597
– Tags	597
RiBat, Battery Manager	199
RiCAD 3D	337
RiCell Flex fuel cell system	205
Ride-up roller	
– for TS, ES, PC	430
RiDiag II	347
RiZone software	345, 346
RJ 45	
– Installation module and extension	616
Roof	431 – 438
Roof mounting screw	438
Roof plates	
– for Data Rack	558
– for DK-TS	436, 437
– for SV-TS	434
– Multi-piece	436
– TS for cooling units	296
Roof vent	220
Roof-mounted	
– Cooling units	244 – 247
– Fans	219, 220
– Heat exchangers air/air	229
– Heat exchangers air/water	252 – 254

## S

Screen, flat	606
Screws	478, 567, 568
Sealing bungs	
– for cable glands	520
Second pair of mounting angles	558
Section doors for cooling modules	249
Section for cable entry	
– for TS, CM, TP	512, 513
Security handle with code	417
Security lock	423
Security rooms	331
Self-tapping screws	478
Semi-cylinder lock	422
Server enclosures	
– Based on Rittal TS 7000	95
– Based on TS 8	92, 93
– for High Performance Cooling	94
Server Switch Control	591
Service socket	509
Shallow air duct system	292
Shallow duct extension	292
Sheet steel door for DK-TS	
– Vented	403
– Vertically divided	404
Sheet steel glazed door,	
– vertically divided	
– for TS	404
Shelves	
– for AE with pull-out frame	487
– See component shelves	480 – 490
Shield bus, EMC	499
Shielding	
– Vertical	283
Shunting ring	533, 534
Shunting ring fibre-optic	535
Side panels	
– Asymmetrical, for TS	386
– for cable chamber	363
– for TE	388
– for top mounting module	433
– Lockable, for TS	387
– Plug-type, divided	388
– Screw-fastened, for TS,	
– sheet steel	385
– Screw-fastened, for TS,	
– stainless steel	385

- Side parts for static installation  
of component shelves 489
- Signal pillars 618, 619  
– Optical components 620
- Single-phase connection cable 204
- SK BUS system 295
- Slide rails 558 – 561  
– for mounting plate TS 446  
– for swing frames 548
- Small distributor  
– Fibre-optic, polycarbonate 67
- Smoke detector 583
- Snap-in cable routing 531
- Snap-on nut TS 471
- Socket strips 505 – 507, 510  
– CMC 508
- Sockets 508, 509
- Software 337 – 347
- Spacers 426  
– for roof plate TS 438
- Spare filter mat  
– for base/plinth component 366  
– for EMC fan-and-filter unit 301  
– for fan-and-filter units/outlet filters 301  
– for filter holder 301  
– for gland plate modules 382, 383  
– for thermoelectric cooler 301
- Spare key 424
- Speed control 295
- Spring nut  
– M5 478
- Spring nuts  
– M6 568
- Spring washer 418
- SSC  
– compact 591  
– Console Cat 5 594  
– Console IP 595  
– Console local 594  
– Converter 595  
– Converter VT100 595  
– Duo 16 593  
– Power Control for SSC premium 596  
– Power Pack 596  
– premium 592  
– view 591
- Stabiliser bracket for base/plinth TS 372
- Stabiliser for TS server enclosures 372
- Stainless steel 158 – 172, 176  
– AE protection category IP 69K 165  
– Base/plinth 370  
– Baying systems TS 8 172  
– Bus enclosures BG 161  
– Cable entry plates 511  
– Cable gland 521  
– Command panel housing with door 167  
– Compact enclosures AE 162 – 164  
– Cooling units – roof-mounted 244 – 247  
– Cooling units – wall-mounted 234 – 243  
– Ex enclosures 176  
– One-piece consoles AP 170  
– PC enclosure systems 171  
– Premium Panel 166  
– Support arm system CP-S 168, 169  
– Switch housing 160  
– Terminal boxes KL 161  
– Viewing window 409
- Stand systems 147 – 151
- Standard light 492
- Stationary base/plinth 366
- Stay  
– Door stay for escape routes 429  
– for door 429  
– for viewing window 408
- Stepped collar 524
- Stoppers  
– for roof-mounted cooling units 292
- Straps, earth straps 501
- Strengtheners  
– for desk unit 105
- Sub-distribution UPS 197, 198
- Subracks  
– Configurator 343
- Supplementary unit  
– ISDN unit 586
- Support  
– for keyboards 610  
– for mousepad 610, 614, 615  
– for small appliances 566
- Support arm bracket 90° CP-L 145
- Support arm configurator 343
- Support arm system  
– Accessories 142 – 146  
– CP-C 134 – 137  
– CP-L 130 – 133  
– CP-S, steel 126 – 129  
– CP-XL 138 – 141
- Support arm, height adjustable,  
for support arm system CP-L/CP-C 144
- Support bracket 473
- Support rail, locatable 450
- Support rails 467  
– 65 x 42 mm for TS, ES 466  
– for polycarbonate enclosures 31  
– for TS, ES, CM 466
- Support strips  
– for AE 426  
– for TS, CM, ES, TP 426, 462
- Support unit, 3 U 574
- Surface connector for enclosures 603
- Surplus cable holder 536
- Swing frame  
– Installation kit 543  
– Large, with trim panel 546  
– Large, without trim panel 545  
– Small, for TS 543  
– Stay 548  
– Vario, for ES 544  
and CS modular enclosures 544
- Switches 591 – 596
- Swivel handle  
for sheet steel door DK-TS 417
- System accessories 355 – 624
- System attachment  
– for frequency converters 263
- System lights 491, 494
- System support rails 466
- System supports  
– for cable routes 535
- System window 407
- ## T
- T handles 420
- Tangential fans 482.6 mm (19") 217, 218
- T-connector piece 475
- TE 7000  
– Network enclosures 85 – 87  
– Open, distributor racks 88  
– Server enclosures 95
- Telescopic slides  
– for component shelves 489
- Temperature display  
and thermostat 293, 294
- Temperature sensor 583
- Temperature/humidity sensor 583
- Terminal boxes KL 34 – 36  
– Cover hinge 425  
– Cover retainer 425  
– HD 154
- TFT  
– Monitor 606  
TFT display, 15" 611  
TFT holder 607  
TFT holder, vertically hinged 607
- Therm software 341
- Thermoelectric cooler 232
- Threaded adaptor 304
- Threaded inserts M6 for KS 478
- Three-phase connection cable  
for PSM busbar 204
- Top mounting module for TS 433
- TopConsole system TP 98 – 105  
– Accessories 105
- Top-hat rail module 569
- Top-hat rails 467
- TopTherm  
– Chillers 264 – 267  
– Fan-and-filter units 212 – 216  
– LCP 279 – 282  
– Wall-mounted cooling units 233, 234
- TopTherm "Blue e"  
– for office and IT applications 246  
– Roof-mounted cooling units 244 – 247  
– Wall-mounted cooling units 235 – 243
- Touchscreen 606
- Touchscreen display  
– for LCP rack, Inline, T3+ TP 283
- One-piece consoles 106  
– Universal consoles 107
- Transport and mounting handle  
– for TS/ES doors 430
- Transport bracket 398
- Transport castors  
– for base/plinth, complete, sheet steel 370  
– for TE 375  
– for TS base/plinth 363
- Transport handles for mounting plates  
– for TS, ES 447
- Transport kit for DK-TS 375
- Transport plinth 368
- Tray, drawer tray 481
- Trim frame  
– for slimline cooling units 297  
– for TS 8 406
- Trim panels  
– for base/plinth 366  
– for cast feet 151  
– for CM 381  
– for pedestal 151  
– for TP 105
- TS  
– Adaptor rail for wiring systems 479  
– Assembly block 463  
– Punched rail 461, 462  
– Punched section  
with mounting flange 459, 460  
– Punched section  
without mounting flange 461  
– Support strips 462
- TS 8 configurator 343
- TS 8 enclosures 68 – 77  
– Corner enclosures 401  
– Door locking 393  
– IP 66/NEMA 4X and NEMA 4 76  
– Isolator door cover 393  
– Network enclosures 80 – 84  
– Server enclosures 90 – 94  
– Stainless steel 172
- Turn-lock fastener  
– for PK 31
- Twin castors 374
- ## U
- U handles 602
- U nuts 477
- Under-floor frame  
– for DK-TS 372
- Universal bracket 476
- Universal consoles TP 107
- Universal light 492
- Universal lock 583
- Universal lock unit 587
- Universal mounting bracket FM 575

# Index

Universal sensor	583
UPS	
– PMC 12	190
– PMC 120	193
– PMC 200	194
– PMC 40 (type 1-4)	191
– PMC 40 (type 5)	192
– PMC 800	195
UPS monitoring card (SNMP card)	198
USB extension	616
Utility bars, vertically hinged	610
Utility lectern	427
Utility table for 482.6 mm (19")	487

## V

Vandalism sensor	583
Variable modular climate control concept	405
Vario swing frame	
– for ES and CS modular enclosures	544
Vent attachment	219
– TS	296
Vent cover	296
Ventilated front panels	564
VerticalBox	54
Viewing window	408
– for operating panel	410
– stainless steel	409
Voltage monitor	583
Voltage supply	505 – 510

## W

Wall angle	440
Wall bracket for TS, ES	440
Wall mounting bracket	439, 440
– for Compact Panel	442
– for CS wall-mounted enclosures	441
– Vertically hinged	442
Wall mounting bracket for AE	439
Wall mounting brackets	
– for cast aluminium enclosures	33
– for polycarbonate enclosures	31
Wall spacer bracket HD	156
Wall-mounted cooling units	233 – 243
Wall-mounted enclosures	
– AE	65, 66
– CS	182
– EL	60 – 64
– QuickBox	57 – 59
– Small fibre-optic distributors	67
Wall-mounted heat exchangers	
– Air/air	226 – 228
– Air/water	255 – 261
Wall-mounted network distributors	53 – 67
Washers, contact washers	501
Width divider	376
Window	
– Viewing window	408, 409
– Viewing window for operating panel	410
Windows	
– System window	407
Wiring plan lectern	427
Wiring plan pockets	428, 429

## RAL colours

	Colour RAL	Designation
	5002	ultramarine blue
	5018	turquoise blue
	7015	slate grey
	7022	umbra grey
	7024	graphite grey
	7030	stone grey
	7032	pebble grey
	7033	cement grey
	7035	pale grey
	8019	grey brown
	9005	jet black
	9006	white aluminium
	9011	graphite black
	9017	traffic black

We reserve the right to further developments and technical modifications of our products. Such modifications, along with errors and printing errata, shall not constitute grounds for compensation. We refer customers to our Terms of Sale and Delivery.

# Rittal – The System.

Faster – better – worldwide.

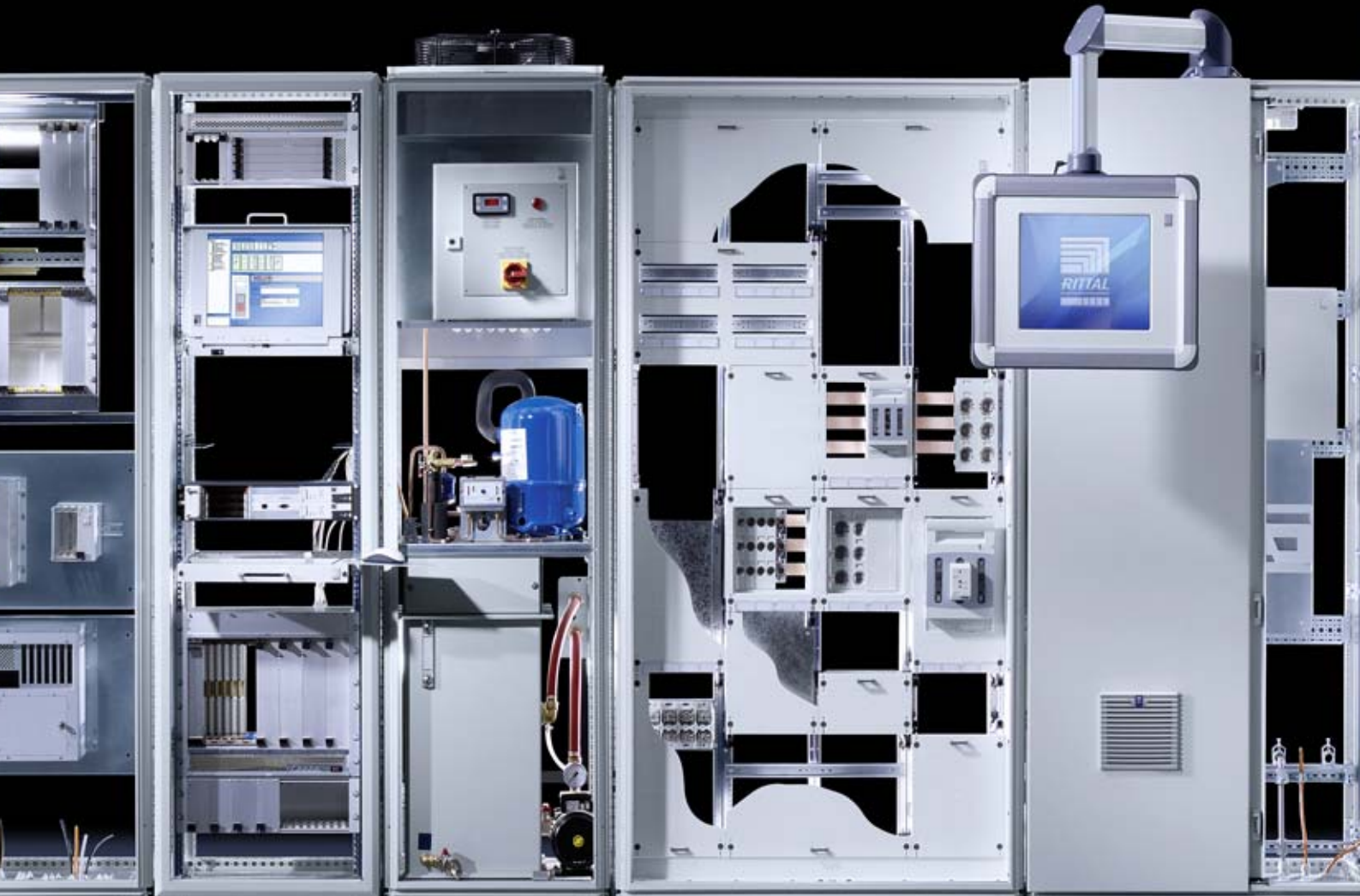

ENCLOSURES

POWER DISTRIBUTION

CLIMATE CONTROL

IT INFRASTRUCTURE

SOFTWARE & SERVICES

FRIEDHELM LOH GROUP



# Rittal – The System.

---

**Faster – better – worldwide.**

- Enclosures
- Power Distribution
- Climate Control
- IT Infrastructure
- Software & Services

12.2011 / E913

RITTAL GmbH & Co. KG  
Postfach 1662 · D-35726 Herborn  
Phone +49(0)2772 505-0 · Fax +49(0)2772 505-2319  
E-mail: [info@rittal.de](mailto:info@rittal.de) · [www.rittal.com](http://www.rittal.com)

ENCLOSURES

POWER DISTRIBUTION

CLIMATE CONTROL

IT INFRASTRUCTURE

SOFTWARE & SERVICES



FRIEDHELM LOH GROUP