



HAZARDOUS LOCATION – DELAYED ACTION

UL LISTED E23572

CSA Certified LR14667

Class I, Div. 1 & 2, Groups C, D
Class I, Zones 1 & 2, IIB, IIA
NEMA 7 (C, D)

FEATURES-SPECIFICATIONS

Applications

KR Series plugs and receptacles are suitable:

- In hazardous locations due to the presence of flammable vapors or gases
- Where a heavy duty plug and receptacle is necessary
- Where a connection is required for portable or movable equipment such as tools, motors, hand lights, etc.
- KP series plugs use solder terminations for sure connection
- KR series receptacles use wire leads for termination

Features

- Factory sealed receptacles
- Copper free aluminum
- Straight or angle type receptacles
- Delayed action contacts (See Time Delay Inset)
- Plugs with a wide range of grommet openings
- Extra long grounding pole makes contact first and breaks contact last
- Heavy duty construction to withstand rough and constant usage

Selection

Refer to page headings for suitability of specific items. When selecting a Killark device consider the following:

- (A) Installation area (Hazardous or Weather-Resistant)
- (B) Amperage
- (C) Voltage
- (D) Electrical Rating (see below)
- (E) Grounding
- (G) Modifications (see right)
- (H) Mounting arrangement
- (I) Box and hub type
- (J) Cord diameter

① CSA approval on 20 Amp only.
UL for 20-60 AMP

Details of Safety Time Delay Feature

The key slot provided in the receptacle engages the key of the plug permitting entrance of the plug in the receptacle in only one position. See steps 1-4.

The contacts are enclosed in long accurate insulating cavities. It is in these cavities that the arcs are extinguished. All contacts are made through round tellurium copper tubing which is extra heavy to withstand arcing as required on the various ampere ratings.

Both plugs and receptacles are equipped with an extra long grounding pole which establishes grounding before the power contacts are engaged. These grounding poles are also the last to break contact. This assures bonding of the portable device to the electrical conduit system.

Selection

Modifications are available by adding the following suffix (SU37 or SU38) to the catalog number and can be used to prevent mismatched voltage connections. (Note: It must be added to both the plug and the receptacle so they will mate.)

MODIFICATIONS	
CATALOG NUMBER	DESCRIPTION
SU37	Interior contact assemblies are to be rotated 22-1/2° to the right.
SU38	Interior contact assemblies are to be rotated 22-1/2° to the left.

Safety Time Delay Feature

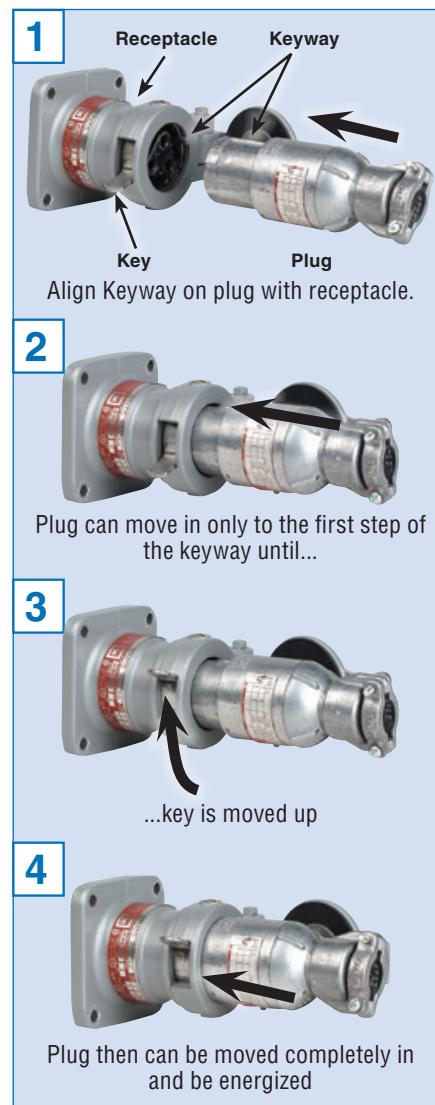

ELECTRICAL RATINGS					
TYPE	AMPERAGE	VOLTAGE VAC	CIRCUIT	H.P.	HERTZ
⊙20 AMP	20	115/230	2W3P	1	60
30 AMP	7	460	2W3P	1/2	60
	7	460	3W4P	1	60
	30	115/230	2W3P	1-1/2	60
	30	115/230	3W4P	3	60
60 AMP	30	460	2W3P	3	60
	30	460	3W4P	5	60
	60	115/230	2W3P	5	60
	60	115/230	3W4P	5	60

RECEPTACLES

KR SERIES



20 AMP 115/230 V.A.C • 1Ø 2 WIRE, 3 POLE



KRS Series



KRA



Plug

Class I, Div. 1 & 2, Groups C, D^①
Class I, Zones 1 & 2, IIB, IIA
NEMA 7 (C, D)

LISTED File No. E23572

Certified File No. LR14667

FEATURES-SPECIFICATIONS

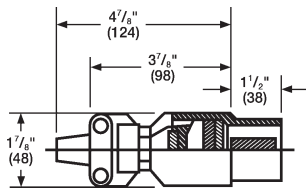

KP 20 AMP PLUG	
CATALOG NO.	DESCRIPTION
KP-20ABC	Plug furnished with 3 grommets range .250 - .625

See page PR21 for available polarization options.

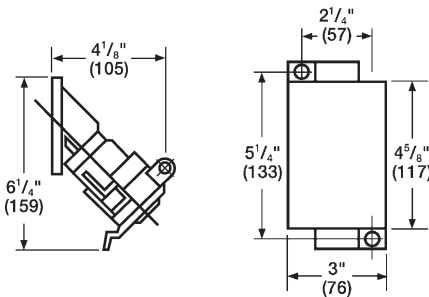

KRS-Series

KRS 20A 1Ø 2W RECEPTACLE WITH SWB BOX ^②								
HUB SIZE	CATALOG NUMBER							
	SINGLE RECEPTACLE & DEAD END BOX	BOX ONLY	SINGLE RECEPTACLE & FEED-THRU BOX	BOX ONLY	DOUBLE RECEPTACLE & DEAD END BOX	BOX ONLY	DOUBLE RECEPTACLE & FEED-THRU BOX	BOX ONLY
1/2"	KRS-215-120	SWB-1	KRS-218-120	SWB-4	2KRS-215-120	SWB-7	2KRS-218-120	SWB-10
3/4"	KRS-215-220	SWB-2	KRS-218-220	SWB-5	2KRS-215-220	SWB-8	2KRS-218-220	SWB-11
1"	KRS-215-320	SWB-3	KRS-218-320	SWB-6	2KRS-215-320	SWB-9	2KRS-218-320	SWB-12

RECEPTACLE ONLY – CATALOG NUMBER KRS-20

^① KRS Series receptacles - Class I, Group D.

^② SWB Series mounting splice boxes only for receptacles shown above listed in Section C of full-line catalog. See page PR22 for available polarization options.

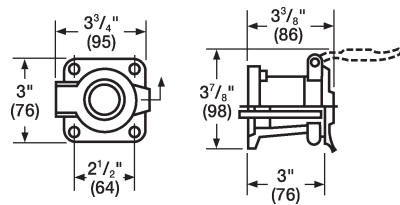

KRJ-Series



AJC



JLC



JLX

ELECTRICAL RATING	
CIRCUIT	RATING (60 HERTZ)
1Ø 2W3P	20 AMPS, 115/230 V.A.C., 1 H.P

KRJ RECEPTACLE WITH AJ OR JL BOX			
HUB SIZE	CATALOG NUMBER		
	AJC	JLC	JLX
1/2"	—	KRJC-120	KRJX-120
3/4"	KRAJC-220	KRJC-220	KRJX-220
1"	KRAJC-320	—	—

BACK BOX ONLY			
HUB SIZE	AJC	JLC	JLX
1/2"	—	JLC-1	JLX-1
3/4"	AJC-2	JLC-2	JLX-2
1"	AJC-3	—	—

RECEPTACLE ONLY – CATALOG NUMBER KRJ-20

JL Series boxes shown in Section F of full-line catalog. Refer to page headings for suitability of specific items. See page PR22 for available polarization options.



KR SERIES

KILLARK

30 AMP 115/230 V.A.C. • 7 AMP 460 V.A.C

KRS/KRJ Series Plug

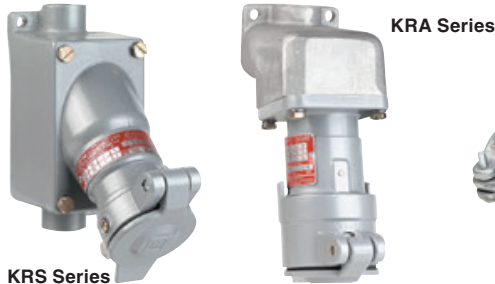

Plug

Class I, Div. 1 & 2, Groups C,D^①
 Class I, Zones 1 & 2, IIB, IIA
 NEMA 7 (C,D)

LISTED - File E23572
 See files for details or call Killark.

FEATURES-SPECIFICATIONS

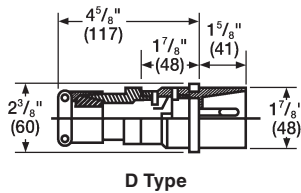

D Type

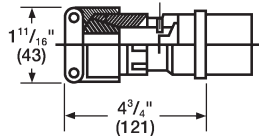

E Type

KP 30 AMP PLUG			
CATALOG NUMBER		PLUG TYPE	GROMMET RANGE
1Ø, 2-WIRE, 3-POLE	3Ø, 3-WIRE 4-POLE		
KP-303D23	KP-304D23	D	.375-.625
KP-303D45	KP-304D45	D	.625-.875
KP-303E45	KP-304E45	E	.875-1.125
KP-303E67	KP-304E67	E	1.125-1.375

See page PR22 for available polarization options.

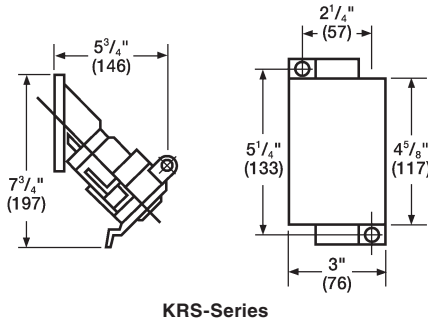

KRS-Series

KRS RECEPTACLE WITH SWB BOX ^②								
HUB SIZE	CATALOG NUMBER - SINGLE GANG ONLY							
	1Ø, 2-WIRE, 3-POLE DEAD END BOX	BOX ONLY	1Ø, 2-WIRE, 3-POLE FEED THRU BOX	BOX ONLY	3Ø, 3-WIRE, 4-POLE DEAD END BOX	BOX ONLY	3Ø, 3-WIRE, 4-POLE FEED THRU BOX	BOX ONLY
1/2"	KRS-215-1303	SWB-1	KRS-218-1303	SWB-4	KRS-215-1304	SWB-1	KRS-218-1304	SWB-4
3/4"	KRS-215-2303	SWB-2	KRS-218-2303	SWB-5	KRS-215-2304	SWB-2	KRS-218-2304	SWB-5
1"	KRS-215-3303	SWB-3	KRS-218-3303	SWB-6	KRS-215-3304	SWB-3	KRS-218-3304	SWB-6
RECEPTACLE ONLY	KRS-303				KRS-304			

^① KRS Series receptacles - Class I, Group D.

^② SWB Series mounting splice boxes for receptacles shown above listed in Section C of full-line catalog. Two gang models not available. See page PR22 for available polarization options.

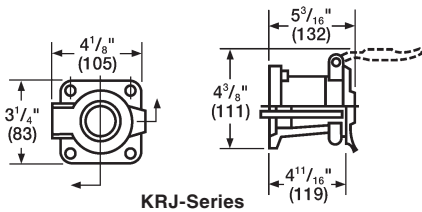

KRJ-Series



AJC

JLC

JLX

ELECTRICAL RATING	
CIRCUIT	RATING (60 HERTZ)
1 Ø	7 Amps, 460 V.A.C., 1 1/2 H.P.
2-Wire	- OR -
3-Pole	30 Amps, 115/230 V.A.C., 1-1 1/2 H.P.
3 Ø	7 Amps, 460 V.A.C., 1 H.P.
3-Wire	- OR -
4-Pole	30 Amps, 115/230 V.A.C., 3 H.P.

KRJ RECEPTACLE WITH AJ OR JL BOX				
CIRCUIT	HUB SIZE	CATALOG NUMBER		
		AJC	JLC	JLX
1Ø 2-Wire 3-Pole	1/2"	—	KRJC-1303	KRJX-1303
	3/4"	KRAJC-2303	KRJC-2303	KRJX-2303
	1"	KRAJC-3303	—	—
RECEPTACLE ONLY - CATALOG NUMBER KRJ-303				
3Ø 3-Wire 4-Pole	1/2"	—	KRJC-1304	KRJX-1304
	3/4"	KRAJC-2304	KRJC-2304	KRJX-2304
	1"	KRAJC-3304	—	—
RECEPTACLE ONLY - CATALOG NUMBER KRJ-304				
Back Box Only	1/2"	—	JLC-1	JLX-1
	3/4"	AJC-2	JLC-2	JLX-2
	1"	AJC-3	—	—

JL Series boxes shown in Section F of full-line catalog. Refer to page headings for suitability of specific items. See page PR22 for available polarization options.

RECEPTACLES

KR SERIES



60 AMP 115/230 V.A.C. • 30 AMP/460 V.A.C.

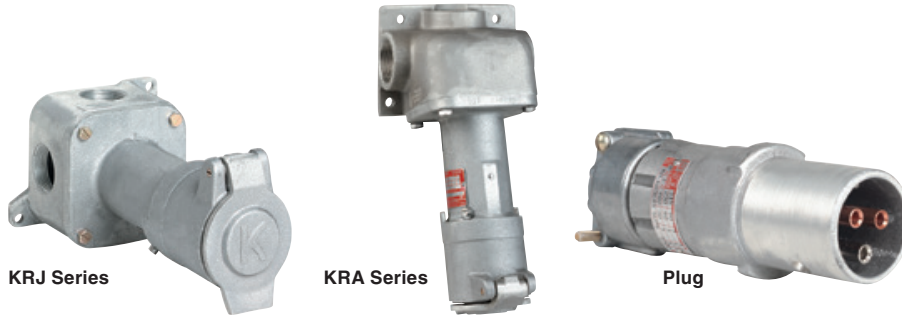

Class I, Div. 1 & 2, Groups C, D
Class I, Zones 1 & 2, IIB, IIA
NEMA 7 (C, D)

UL LISTED File No. E23572

FEATURES-SPECIFICATIONS

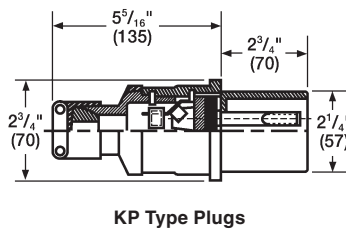
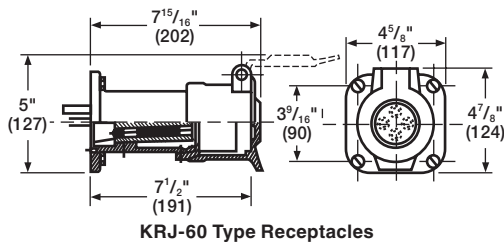

KR 60 AMP PLUGS		
CATALOG NUMBER		GROMMET RANGE
1Ø, 2-WIRE, 3-POLE	3Ø, 3-WIRE 4-POLE	
KP-603D345	KP-604D345	.500-.875
KP-603E45	KP-604E45	.875-1.125
KP-603E67	KP-604E67	1.125-1.375
—	KP-604F34	1.250-1.500
—	KP-604F56	1.500-1.750

See page PR22 for available polarization options.

Dimensions-Back Boxes

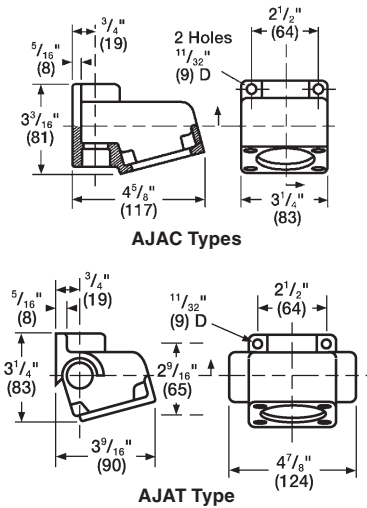

KR RECEPTACLE ASSEMBLIES					
HUB SIZE	BOX STYLE	HUB STYLE	CATALOG NUMBER		
			1Ø, 2-WIRE 3-POLE	3Ø, 3-WIRE 4-POLE	SPLICE BOX ONLY
1"	JAL Series Boxes	"X"-3 Close-up Plugs Supplied	KRJX-3603	KRJX-3604	JALX-3
1-1/4"			KRJX-4603	KRJX-4604	JALX-4
—	—	—	—	—	—
1-1/4"	AJA Series Boxes	Feed Thru Top and Bottom	KRAJAC-4603	KRAJAC-4604	AJAC-4
1-1/2"			KRAJAC-5603	KRAJAC-5604	AJAC-5
2"		KRAJAC-6603	KRAJAC-6604	AJAC-6	
1-1/4"		T Sides and Top	KRAJAT-4603	KRAJAT-4604	AJAT-4
1-1/2"	KRAJAT-5603		KRAJAT-5604	AJAT-5	
RECEPTACLE ONLY			KRJ-603	KRJ-604	—

NOTE: For dead end box, use AJAC Series and CUP Series close-up plug.
See page PR22 for available polarization options.

ELECTRICAL RATING	
CIRCUIT	RATING (60 HERTZ)
1 Ø	30 Amps, 460 V.A.C., 3 H.P.
2-Wire	— OR —
3-Pole	60 Amps, 115/230 V.A.C., 3 H.P.
3 Ø	30 Amps, 460 V.A.C., 5 H.P.
3-Wire	— OR —
4-Pole	60 Amps, 115/230 V.A.C., 5 H.P.

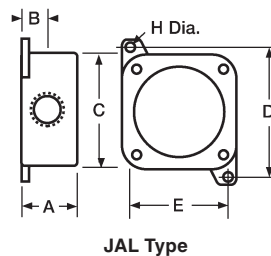

JAL TYPE MOUNTING BOXES						
HUB	A	B	C	D	E	H
1"	2-3/8"	1-5/32"	4-5/8"	5-1/4"	4-1/8"	5/16"
1-1/4"	3-1/8"	1-17/32"	4-5/8"	5-1/4"	4-1/8"	5/16"