

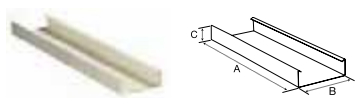

Metal Raceway







HBL4750 Series

Metal Raceway and Fittings

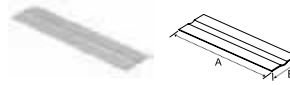

HBL4750 Series	Description	Color	Catalog Number	Description	Color	Catalog Number
	<p>Single Channel Base Packed 50 ft. (15.24m) per carton, 10 ft. (3m) lengths.</p> <p>Assembled cover and base dimensions. W: 4.75" (120.65) H: 1.75" (44.45)</p> 	Ivory Gray	HBL4750B10IV HBL4750B10GY A: 120.00" (3048.00) B: 4.75" (120.65) C: 1.62" (41.20)	<p>5 Ft. Cover Packed 50 ft. (15.24m) per carton, 5 ft. (1.5m) lengths.</p> <p>31.5 In. Precut Cover* For 36 in. (915.00) centers with HBL4747 and HBL4750 Plates.</p> <p>19.5 In. Precut Cover* For 24 in. (610.00) centers with HBL4747 and HBL4750 Plates.</p> <p>13.5 In. Precut Cover* For 18 in. (457.00) centers with HBL4747 and HBL4750 Plates.</p> <p>7.5 In. Precut Cover* For 12 in. (305.00) centers with HBL4747 and HBL4750 Plates.</p> 	Ivory Gray	HBL4750CIV HBL4750CGY A: 60.00" (1,524.0) B: 4.75" (120.65) HBL4750C315IV HBL4750C315GY A: 31.50" (800.10) B: 4.75" (120.65) HBL4750C195IV HBL4750C195GY A: 19.50" (495.30) B: 4.75" (120.65) HBL4750C135IV HBL4750C135GY A: 13.50" (342.90) B: 4.75" (120.65) HBL4750C075IV HBL4750C075GY A: 7.50" (190.50) B: 4.75" (120.65)

Note: * Packed 10 pieces per carton. Device centers vary based on cover selection. Consult factory for details.

Fittings	Description	Color	Catalog Number	Description	Color	Catalog Number
	<p>Divider Divides HBL4750 Raceway into two channels. Packed 50 ft. (15.24m) per carton, 5 ft. (1.5m) lengths. HBL4751DA Divider Clips are required to hold divider in place.</p> 	Painted Steel	HBL4750DGY A: 60.00" (1,524.0) B: 1.51" (38.46)	<p>By-Pass Divider Divides HBL4750 Raceway into two channels with a 70/30 split. Allows for a larger power or datacom wire fill. HBL4751DA Divider Clips are required to hold divider in place.</p> 	Painted Steel	HBL4750BP A: 7.12" (180.74) B: .89" (22.54)
<p>Divider Clip Required for holding HBL4750DGY in place. Use one every 2.5 ft. (.762m).</p> 	Steel**	HBL4751DA A: 4.64" (117.77) B: 1.46" (37.07)	<p>Wire Clip (Plated) For holding conductors in place.</p> 	Steel**	HBL4750WCGY A: 4.60" (116.74) B: 1.58" (40.13) C: 1.00" (25.40)	
<p>Internal Corner Coupling (Plated) Concealed fitting for making an internal corner while continuing original run in a straight line.</p> 	Steel**	HBL4717TCAGY A: 4.59" (116.59) B: 2.71" (68.73) C: 1.47" (37.34)	<p>Coupling (Plated) For joining lengths of HBL4750 Raceway. Sold in pairs.</p> 	Steel**	HBL4751AC A: 1.47" (37.30) B: .42" (10.59)	

Note: ** Galvanized Steel.