

Raceway
Non-Metallic Raceway
Non-Latching PremiseTrak[®] Base and Cover

HUBBELL

Features

- Comes without Adhesive
- Single channel raceway
- Available in 5 ft. (1.5m) and 7 ft. (2.1m) lengths

Ordering Information

Description	Color	UPC Number	Catalog Number
Base and Cover	Office White	783585337838	PT1BC5

Listings

UL Listed
 CSA Certified

Specifications

Height	0.68"
Width	0.75"
Length	5'

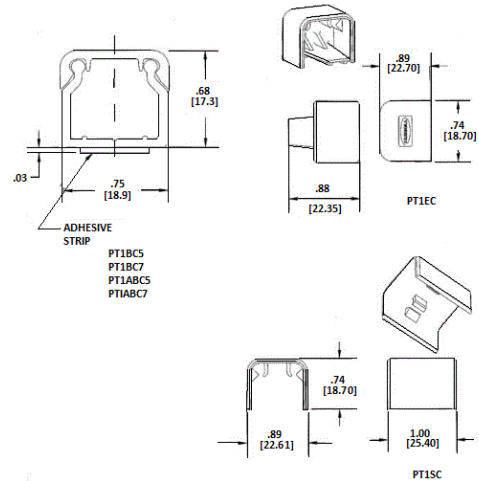

Online Resources

Customer Use Drawing
 eCatalog
 Installation Instructions

Dimensions in Inches (mm)

Hubbell Wiring Device-Kellems • Hubbell Incorporated (Delaware) • 40 Waterview Drive • Shelton, CT 06484

Phone (800) 288-6000 • Fax (800) 255-1031 • Specifications subject to change without notice.

