

**Floor Boxes**  
**Flush Rectangular Stamped Steel**  
**Concrete Floor Boxes**



**Features**

- Stamped steel construction
- Concentric knockouts permit various conduit sizes
- Economical and light weight for above-grade applications



**Ordering Information**

Description	Style	UPC	Catalog Number
2-Gang Deep,	Stamped Steel	783585104225	BA2432

**Listings**

UL File Number E92074  
 CSA File Number LR18416

**Specifications**

Collar Material	Aluminum
Size	2-Gang
Min. Depth of Pour	3.75" (95.3)
Cubic Capacity	52.8 cu. in. (865.2 cm <sup>3</sup> )

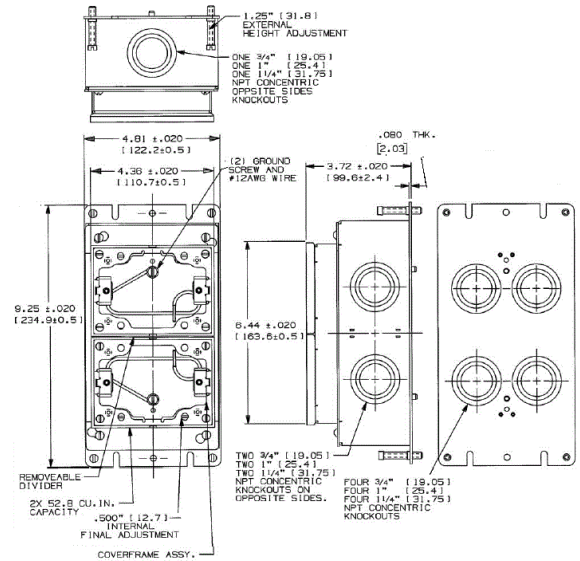

**Online Resources**

- Customer Use Drawing
- eCatalog
- Installation Instructions

